



TEST REPORT

FCC PART 15.247

Report Reference No. : CTL2406241011-WF02

Compiled by: Happy Guo
(position+printed name+signature) (File administrators)

Tested by: Jack Wang
(position+printed name+signature) (Test Engineer)

Approved by: Ivan Xie
(position+printed name+signature) (Manager)



Product Name : speake

Model/Type reference : WH-4409

List Model(s)..... : Please look at page 2

Trade Mark..... : N/A

FCC ID..... : 2BHJS-WH-4409

Applicant's name : GUANGZHOU WEIHAO XUNDA ELECTRONIC CO., LTD

Address of applicant : NO.7,Xiyi-Lu,Huangbanling Road,Baiyun District,Guangzhou city,China

Test Firm..... : Shenzhen CTL Testing Technology Co., Ltd.

Address of Test Firm : Floor 1-A, Baisha Technology Park, No.3011, Shahexi Road, Nanshan District, Shenzhen, China 518055

Test specification..... :

Standard : FCC Part 15.247: Operation within the bands 902-928 MHz, 2400-2483.5 MHz and 5725-5850 MHz.

TRF Originator : Shenzhen CTL Testing Technology Co., Ltd.

Master TRF..... : Dated 2011-01

Date of receipt of test item : Jun. 27, 2024

Date of Test Date..... : Jun. 27, 2024-Jul.12, 2024

Date of Issue : Jul.16, 2024

Result..... : Pass

Shenzhen CTL Testing Technology Co., Ltd. All rights reserved.

This publication may be reproduced in whole or in part for non-commercial purposes as long as the Shenzhen CTL Testing Technology Co., Ltd. is acknowledged as copyright owner and source of the material. Shenzhen CTL Testing Technology Co., Ltd. takes no responsibility for and will not assume liability for damages resulting from the reader's interpretation of the reproduced material due to its placement and context.

TEST REPORT

Test Report No. :	CTL2406241011-WF02	Jul.16, 2024
		Date of issue

Equipment under Test : speake

Sample No : CTL2406241011

Model /Type : WH-4409

Listed Models : AUD-X105,AUD-X110,AUD-X115,AUD-X120,AUD-X125, AUD-X130,AUD-X135,AUD-X140,AUD-X145,AUD-X150, AUD-X155,AUD-X160,AUD-X165,AUD-X170,AUD-X175, AUD-X180,AUD-X185,AUD-X190,AUD-X195,AUD-X200, AUD-X205,AUD-X210,AUD-X215,AUD-X220,AUD-X225, AUD-X230,AUD-X235,AUD-X240,AUD-X245,AUD-X250, AUD-X255,AUD-X260,AUD-X265,AUD-X270,AUD-X275, AUD-X280,AUD-X285,AUD-X290,AUD-X295,AUD-X300, WH-4401,WH-4402,WH-4403,WH-4404,WH-4405,WH-4406, WH-4407,WH-4408,WH-4409,WH-4410,WH-4411,WH-4412, WH-810,WH-811,WH-812,WH-3303,WH-4416,WH-4441, WH-4418,WH-4419,WH-4420,WH-4421,WH-4422,WH-4422A, WH-4423,WH-4442,WH-8800

Applicant : **GUANGZHOU WEIHAO XUNDA ELECTRONIC CO., LTD**

Address : NO.7,Xiyi-Lu,Huangbanling Road,Baiyun District,Guangzhou city,China

Manufacturer : **GUANGZHOU WEIHAO XUNDA ELECTRONIC CO., LTD**

Address : NO.7,Xiyi-Lu,Huangbanling Road,Baiyun District,Guangzhou city,China

Test result	Pass *
--------------------	---------------

* In the configuration tested, the EUT complied with the standards specified page 5.

The test results presented in this report relate only to the object tested.

This report shall not be reproduced, except in full, without the written approval of the issuing testing laboratory.

Table of Contents

Page

1. SUMMARY	5
1.1. TEST STANDARDS	5
1.2. TEST DESCRIPTION	5
1.3. TEST FACILITY	6
1.4. STATEMENT OF THE MEASUREMENT UNCERTAINTY	6
2. GENERAL INFORMATION	8
2.1. ENVIRONMENTAL CONDITIONS	8
2.2. GENERAL DESCRIPTION OF EUT	8
2.3. DESCRIPTION OF TEST MODES AND TEST FREQUENCY	9
2.4. EQUIPMENTS USED DURING THE TEST	10
2.5. RELATED SUBMITTAL(S) / GRANT (S)	10
2.6. MODIFICATIONS	10
3. TEST CONDITIONS AND RESULTS	11
3.1. CONDUCTED EMISSIONS TEST	11
3.2. RADIATED EMISSIONS AND BAND EDGE	14
3.3. MAXIMUM CONDUCTED OUTPUT POWER	26
3.4. POWER SPECTRAL DENSITY	27
3.5. 6DB BANDWIDTH	28
3.6. OUT-OF-BAND EMISSIONS	29
3.7. ANTENNA REQUIREMENT	30
4. TEST SETUP PHOTOS OF THE EUT	31
5. EXTERNAL AND INTERNAL PHOTOS OF THE EUT	32

1. SUMMARY

1.1. TEST STANDARDS

The tests were performed according to following standards:

[FCC Rules Part 15.247](#): Frequency Hopping, Direct Spread Spectrum and Hybrid Systems that are in operation within the bands of 902-928 MHz, 2400-2483.5 MHz, and 5725-5850 MHz

[ANSI C63.10: 2013](#): American National Standard for Testing Unlicensed Wireless Devices

[KDB 558074 D01 15.247 Meas Guidance v05r02](#) : Guidance for Performing Compliance Measurements on Digital Transmission Systems (DTS) Operating Under §15.247

1.2. Test Description

FCC PART 15.247		
FCC Part 15.207	AC Power Conducted Emission	PASS
FCC Part 15.247(a)(2)	6dB Bandwidth	PASS
FCC Part 15.247(d)	Spurious RF Conducted Emission	PASS
FCC Part 15.247(b)	Maximum Conducted Output Power	PASS
FCC Part 15.247(e)	Power Spectral Density	PASS
FCC Part 15.109/ 15.205/ 15.209	Radiated Emissions	PASS
FCC Part 15.247(d)	Band Edge	PASS
FCC Part 15.203/15.247 (b)	Antenna Requirement	PASS

Note: N/A= not applicable

1.3. Test Facility

1.3.1 Address of the test laboratory

Shenzhen CTL Testing Technology Co., Ltd.

Floor 1-A, Baisha Technology Park, No.3011, Shahexi Road, Nanshan District, Shenzhen, China 518055

There is one 3m semi-anechoic chamber and two line conducted labs for final test. The Test Sites meet the requirements in documents ANSI C63.10 and CISPR 32/EN 55032 requirements.

1.3.2 Laboratory accreditation

The test facility is recognized, certified, or accredited by the following organizations:

CNAS-Lab Code: L7497

Shenzhen CTL Testing Technology Co., Ltd. has been assessed and proved to be in compliance with CNAS-CL01 Accreditation Criteria for Testing and Calibration Laboratories (identical to ISO/IEC 17025: 2017 General Requirements) for the Competence of Testing and Calibration Laboratories.

A2LA-Lab Cert. No. 4343.01

Shenzhen CTL Testing Technology Co., Ltd, EMC Laboratory has been accredited by A2LA for technical competence in the field of electrical testing, and proved to be in compliance with ISO/IEC 17025: 2017 General Requirements for the Competence of Testing and Calibration Laboratories and any additional program requirements in the identified field of testing.

IC Registration No.: 9618B

CAB identifier: CN0041

The 3m alternate test site of Shenzhen CTL Testing Technology Co., Ltd. EMC Laboratory has been registered by Innovation, Science and Economic Development Canada to test to Canadian radio equipment requirements with Registration No.: 9618B.

FCC-Registration No.: 399832

Designation No.: CN1216

Shenzhen CTL Testing Technology Co., Ltd. EMC Laboratory has been registered and fully described in a report filed with the (FCC) Federal Communications Commission. The acceptance letter from the FCC is maintained in our files. Registration 399832.

1.4. Statement of the measurement uncertainty

The data and results referenced in this document are true and accurate. The reader is cautioned that there may be errors within the calibration limits of the equipment and facilities. The measurement uncertainty was calculated for all measurements listed in this test report acc. to CISPR 16 - 4 "Specification for radio disturbance and immunity measuring apparatus and methods – Part 4: Uncertainty in EMC Measurements" and is documented in the Shenzhen CTL Testing Technology Co., Ltd. quality system acc. to DIN EN ISO/IEC 17025. Furthermore, component and process variability of devices similar to that tested may result in additional deviation. The manufacturer has the sole responsibility of continued compliance of the device.

Hereafter the best measurement capability for CTL laboratory is reported:

Test	Measurement Uncertainty	Notes
Transmitter power Radiated	±2.20 dB	(1)
Occupied Bandwidth	±0.02ppm	(1)
Radiated Emission 30~1000MHz	±4.10dB	(1)
Radiated Emission Above 1GHz	±4.32dB	(1)
Conducted Disturbance0.15~30MHz	±2.96dB	(1)
20dB Emission Bandwidth	±1.9%	(1)

Carrier Frequency Separation	$\pm 1.9\%$	(1)
Maximum Power Spectral Density Level	± 0.98 dB	(1)
Number of Hopping Channel	$\pm 1.9\%$	(1)
Time of Occupancy	$\pm 0.11\%$	(1)
Max Peak Conducted Output Power	± 0.98 dB	(1)
Band-edge Spurious Emission	± 1.21 dB	(1)
Conducted RF Spurious Emission	9kHz-7GHz: ± 1.09 dB 7GHz-26.5GHz: ± 3.27 dB	(1)

- (1) This uncertainty represents an expanded uncertainty expressed at approximately the 95% confidence level using a coverage factor of $k=1.96$.

2. GENERAL INFORMATION

2.1. Environmental conditions

During the measurement the environmental conditions were within the listed ranges:

Normal Temperature:	25°C
Relative Humidity:	55 %
Air Pressure:	101 kPa

2.2. General Description of EUT

Product Name:	speake
Model/Type reference:	WH-4409
Power supply:	DC 3.7V form battery
Bluetooth LE	
Supported type:	Bluetooth Low Energy
Modulation:	GFSK
Operation frequency:	2402MHz~2480MHz
Channel number:	40
Channel separation:	2MHz
Antenna type:	PCB Antenna
Antenna gain:	1.7 dBi

Note1: For more details, please refer to the user's manual of the EUT.

Note2: Antenna gain provided by the applicant.

2.3. Description of Test Modes and Test Frequency

The Applicant provides communication tools software to control the EUT for staying in continuous transmitting (Duty Cycle more than 98%) and receiving mode for testing.

There are 40 channels provided to the EUT and Channel 00/19/39 were selected for BLE test.

Operation Frequency List :

Channel	Frequency (MHz)
00	2402
02	2404
03	2406
:	:
19	2440
:	:
37	2476
38	2478
39	2480

Note: The line display in grey were the channel selected for testing

2.4. Equipments Used during the Test

Test Equipment	Manufacturer	Model No.	Serial No.	Calibration Date	Calibration Due Date
LISN	R&S	ESH2-Z5	860014/010	2024/04/30	2025/04/29
Limitator	ROHDE & SCHWARZ	ESH3-Z2	100408	2024/04/30	2025/04/29
EMI Test Receiver	ROHDE & SCHWARZ	ESCI	1166.5950.03	2024/04/30	2025/04/29
Double cone logarithmic antenna	Schwarzbeck	VULB 9168	824	2023/02/13	2026/02/12
EMI Test Receiver	R&S	ESCI	1166.5950.03	2024/04/30	2025/04/29
Spectrum Analyzer	Agilent	N9020A	US46220290	2024/05/02	2025/05/01
Spectrum Analyzer	Keysight	N9020A	MY53420874	2024/05/02	2025/05/01
Horn Antenna	Sunol Sciences Corp.	DRH-118	A062013	2021/12/23	2024/12/22
Active Loop Antenna	Da Ze	ZN30900A	/	2024/04/30	2025/04/29
Amplifier	Agilent	8449B	3008A02306	2024/04/30	2025/04/29
Amplifier	Brief&Smart	LNA-4018	2104197	2024/05/03	2025/05/02
Temperature/Humidity Meter	Ji Yu	MC501	/	2024/05/04	2025/05/03
Power measurement module	TSTPASS	TSPS2023R	TSCB220016	2024/05/03	2025/05/02
Power Sensor	Agilent	U2021XA	MY53340004	2024/05/04	2025/05/03
Power Sensor	Agilent	U2021XA	MY54080012	2024/05/03	2025/05/02
Spectrum Analyzer	RS	FSP	1164.4391.38	2024/05/03	2025/05/02
Test Software					
Name of Software			Version		
TST-PASS			V2.0		
EZ_EMG(Below 1GHz)			V1.1.4.2		
EZ_EMG(Above 1GHz)			V1.1.4.2		

2.5. Related Submittal(s) / Grant (s)

This submittal(s) (test report) is intended to comply with Section 15.247 of the FCC Part 15, Subpart C Rules.

2.6. Modifications

No modifications were implemented to meet testing criteria.

3. TEST CONDITIONS AND RESULTS

3.1. Conducted Emissions Test

LIMIT

FCC CFR Title 47 Part 15 Subpart C Section 15.207

Frequency range (MHz)	Limit (dBuV)	
	Quasi-peak	Average
0.15-0.5	66 to 56*	56 to 46*
0.5-5	56	46
5-30	60	50

* Decreases with the logarithm of the frequency.

TEST CONFIGURATION

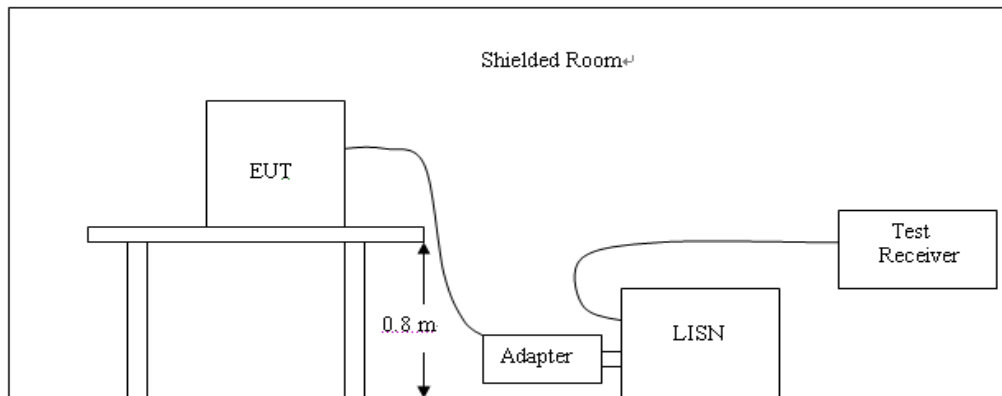

TEST PROCEDURE

1. The equipment was set up as per the test configuration to simulate typical actual usage per the user's manual. The EUT is a Smart Watchop system; a wooden table with a height of 0.8 meters is used and is placed on the ground plane as per ANSI C63.10:2013.
2. Support equipment, if needed, was placed as per ANSI C63.10:2013.
3. All I/O cables were positioned to simulate typical actual usage as per ANSI C63.10:2013.
4. The adapter received AC120V/60Hz power through a Line Impedance Stabilization Network (LISN) which supplied power source and was grounded to the ground plane.
5. All support equipments received AC power from a second LISN, if any.
6. The EUT test program was started. Emissions were measured on each current carrying line of the EUT using a spectrum Analyzer / Receiver connected to the LISN powering the EUT. The LISN has two monitoring points: Line 1 (Hot Side) and Line 2 (Neutral Side). Two scans were taken: one with Line 1 connected to Analyzer / Receiver and Line 2 connected to a 50 ohm load; the second scan had Line 1 connected to a 50 ohm load and Line 2 connected to the Analyzer / Receiver.
7. Analyzer / Receiver scanned from 150 KHz to 30MHz for emissions in each of the test modes.
8. During the above scans, the emissions were maximized by cable manipulation.

TEST RESULTS

Remark:

1. All low, middle and high channel were tested; only the worst result of low channel was reported as below:

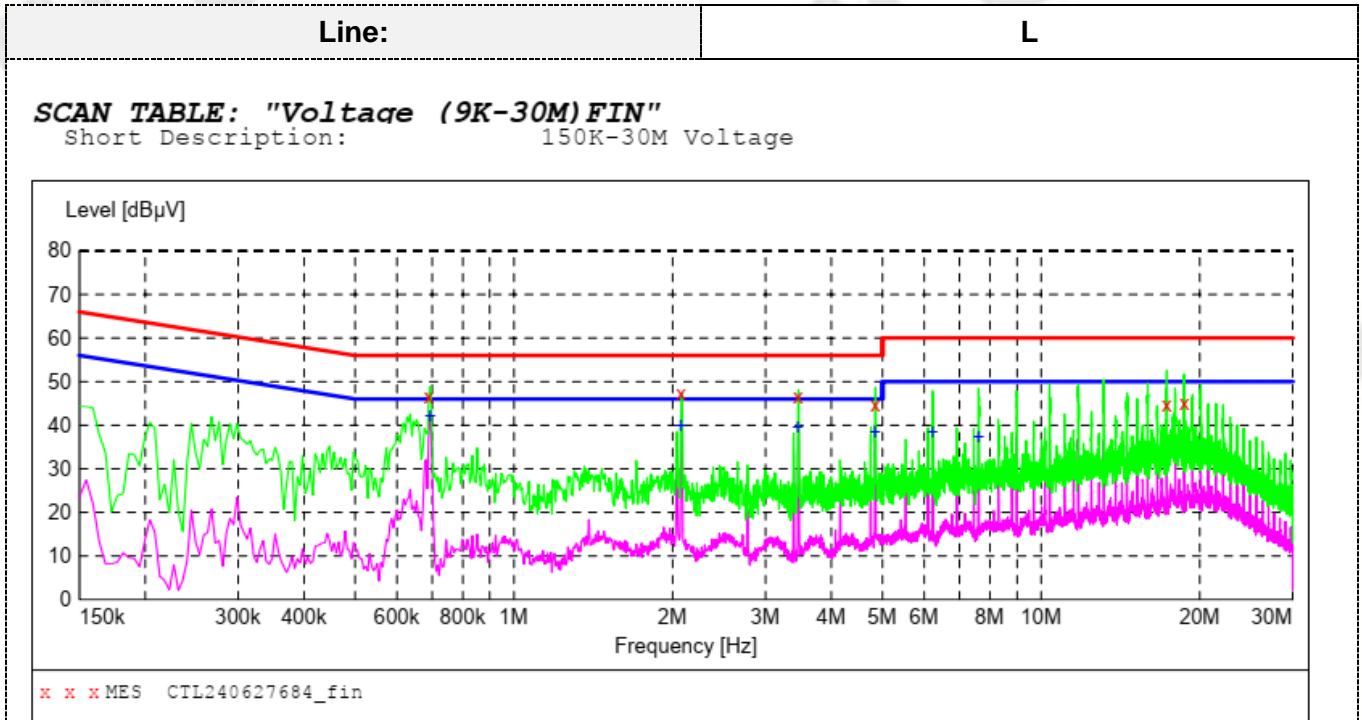

MEASUREMENT RESULT: "CTL240627684_fin"

7/2/2024 9:17AM

Frequency MHz	Level dBµV	Transd dB	Limit dBµV	Margin dB	Detector	Line	PE
0.690000	46.60	10.0	56	9.4	QP	L1	GND
2.076000	47.20	10.1	56	8.8	QP	L1	GND
3.462000	46.70	10.1	56	9.3	QP	L1	GND
4.852500	44.90	10.1	56	11.1	QP	L1	GND
17.308500	44.70	11.2	60	15.3	QP	L1	GND
18.685500	45.20	11.2	60	14.8	QP	L1	GND

MEASUREMENT RESULT: "CTL240627684_fin2"

7/2/2024 9:17AM

Frequency MHz	Level dBµV	Transd dB	Limit dBµV	Margin dB	Detector	Line	PE
0.694500	42.20	10.0	46	3.8	AV	L1	GND
2.076000	39.90	10.1	46	6.1	AV	L1	GND
3.462000	39.40	10.1	46	6.6	AV	L1	GND
4.848000	38.60	10.1	46	7.4	AV	L1	GND
6.229500	38.40	10.2	50	11.6	AV	L1	GND
7.615500	37.50	10.4	50	12.5	AV	L1	GND

Line:	N
-------	---

SCAN TABLE: "Voltage (9K-30M)FIN"
 Short Description: 150K-30M Voltage

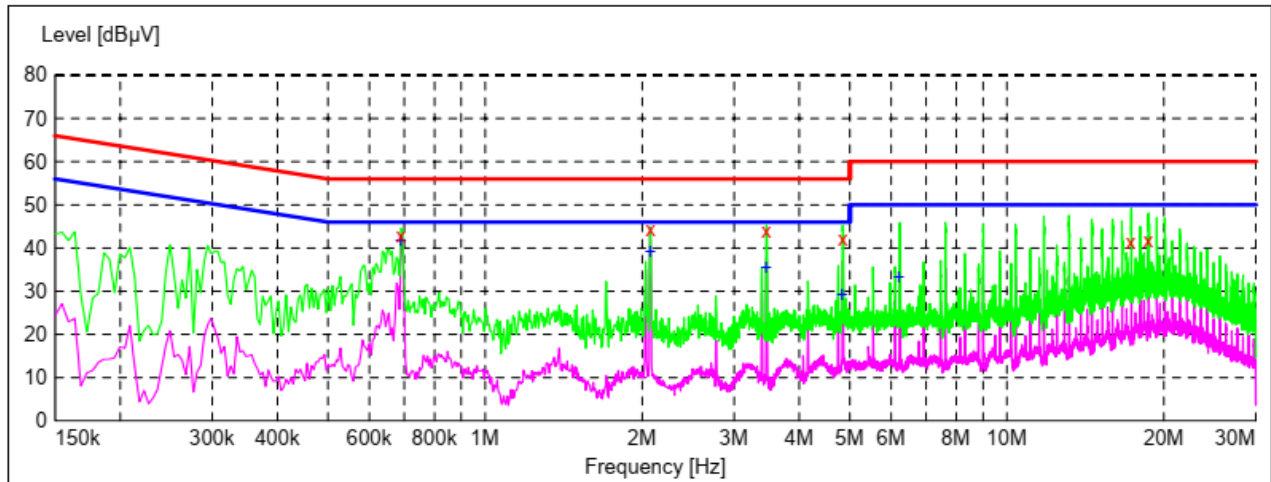

x x x MES CTL240627685_fin

MEASUREMENT RESULT: "CTL240627685_fin"

7/2/2024 9:19AM

Frequency MHz	Level dBµV	Transd dB	Limit dBµV	Margin dB	Detector	Line	PE
0.690000	42.80	10.0	56	13.2	QP	N	GND
2.076000	44.50	10.1	56	11.5	QP	N	GND
3.462000	44.10	10.1	56	11.9	QP	N	GND
4.848000	42.20	10.1	56	13.8	QP	N	GND
17.286000	41.60	11.2	60	18.4	QP	N	GND
18.667500	41.90	11.2	60	18.1	QP	N	GND

MEASUREMENT RESULT: "CTL240627685_fin2"

7/2/2024 9:19AM

Frequency MHz	Level dBµV	Transd dB	Limit dBµV	Margin dB	Detector	Line	PE
0.690000	41.90	10.0	46	4.1	AV	N	GND
2.076000	39.20	10.1	46	6.8	AV	N	GND
3.457500	35.30	10.1	46	10.7	AV	N	GND
4.839000	29.20	10.1	46	16.8	AV	N	GND
6.225000	33.10	10.2	50	16.9	AV	N	GND

3.2. Radiated Emissions and Band Edge

Limit

For intentional device, according to § 15.209(a), the general requirement of field strength of radiated emission out of authorized band shall not exceed the following table at a 3 meters measurement distance.

In addition, radiated emissions which fall in the restricted bands, as defined in §15.205(a), must also comply with the radiated emission limits specified in §15.209(a)

Radiated emission limits

Frequency (MHz)	Distance (Meters)	Radiated (dB μ V/m)	Radiated (μ V/m)
0.009-0.49	3	$20\log(2400/F(\text{KHz}))+40\log(300/3)$	$2400/F(\text{KHz})$
0.49-1.705	3	$20\log(24000/F(\text{KHz}))+40\log(30/3)$	$24000/F(\text{KHz})$
1.705-30	3	$20\log(30)+40\log(30/3)$	30
30-88	3	40.0	100
88-216	3	43.5	150
216-960	3	46.0	200
Above 960	3	54.0	500

TEST CONFIGURATION

(A) Radiated Emission Test Set-Up, Frequency Below 30MHz

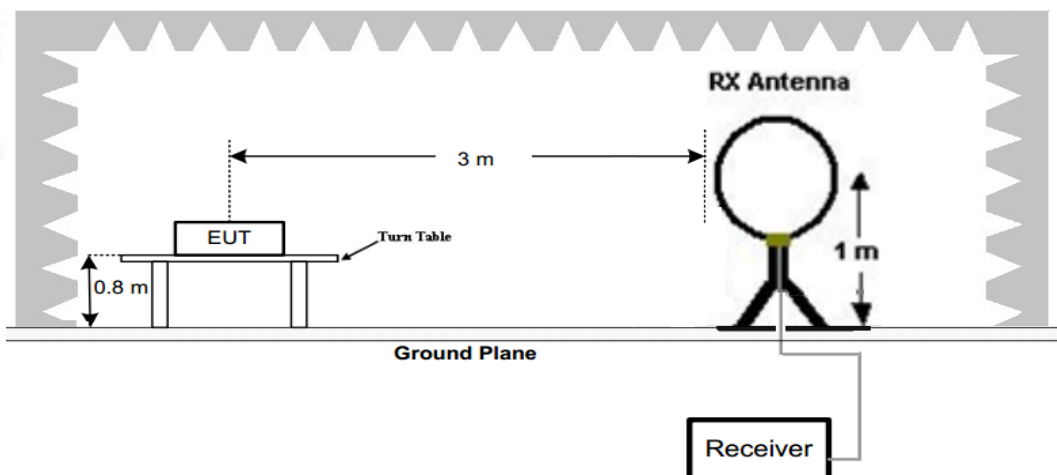

(B) Radiated Emission Test Set-Up, Frequency below 1000MHz

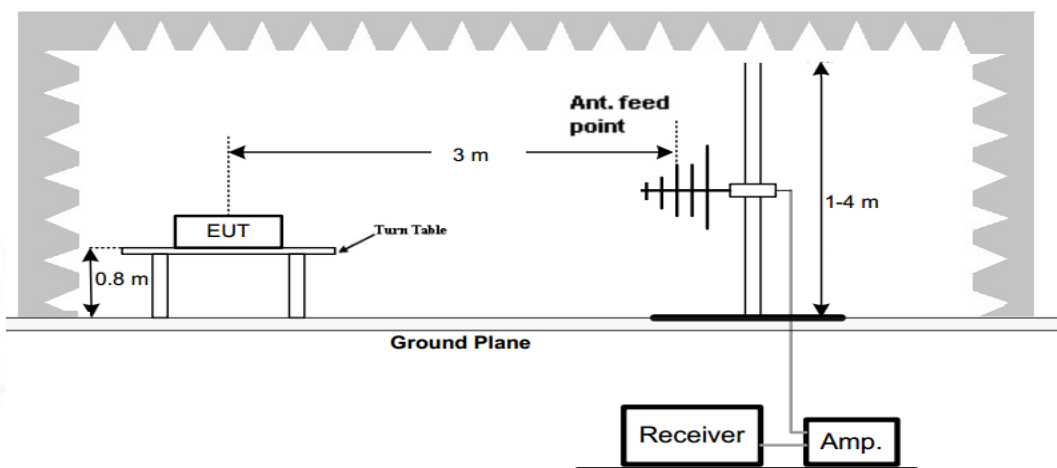

(C) Radiated Emission Test Set-Up, Frequency above 1000MHz

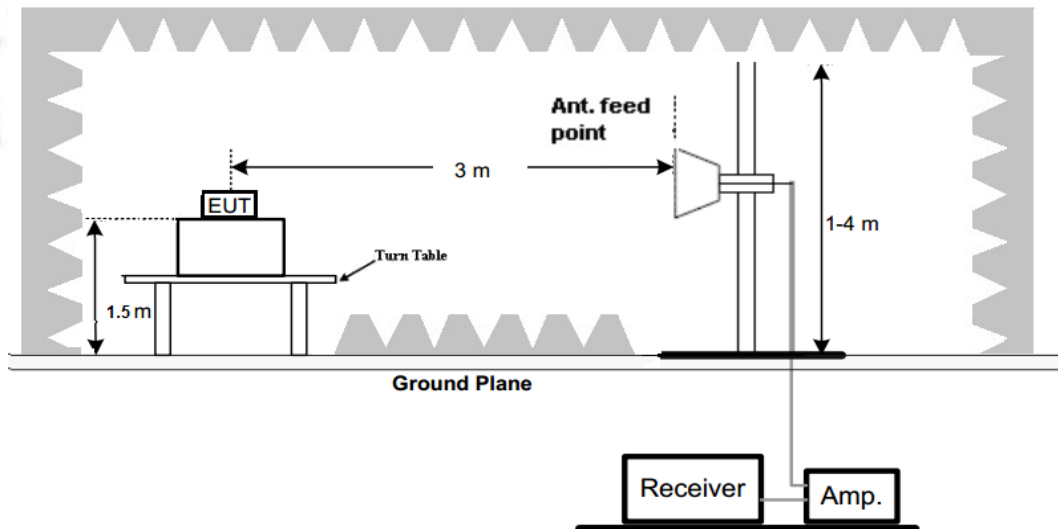
**Test Procedure**

1. Below 1GHz measurement the EUT is placed on a turntable which is 0.8m above ground plane, and above 1GHz measurement EUT was placed on a low permittivity and low loss tangent turn table which is 1.5m above ground plane.
2. Maximum procedure was performed by raising the receiving antenna from 1m to 4m and rotating the turn table from 0° to 360° to acquire the highest emissions from EUT
3. And also, each emission was to be maximized by changing the polarization of receiving antenna both horizontal and vertical.
4. Repeat above procedures until all frequency measurements have been completed.
5. The EUT was pretested with 3 orientations placed on the table for the radiated emission
6. measurement –X, Y, and Z-plane. The X-plane results were found as the worst case and were
7. shown in this report

TEST RESULTS

Remark:

1. We have tested low channel, middle channel, high channel, only recorded worst at low channel.
2. Radiated emission test from 9 KHz to 10th harmonic of fundamental was verified, Found the emission level are attenuated 20dB below the limits from 9 kHz to 30MHz, so it does not recorded in report.

For 30MHz-1GHz

Horizontal



Shenzhen CTL Testing Technology Co., Ltd
Tel: +86-755-89486194

Radiated Emission Measurement

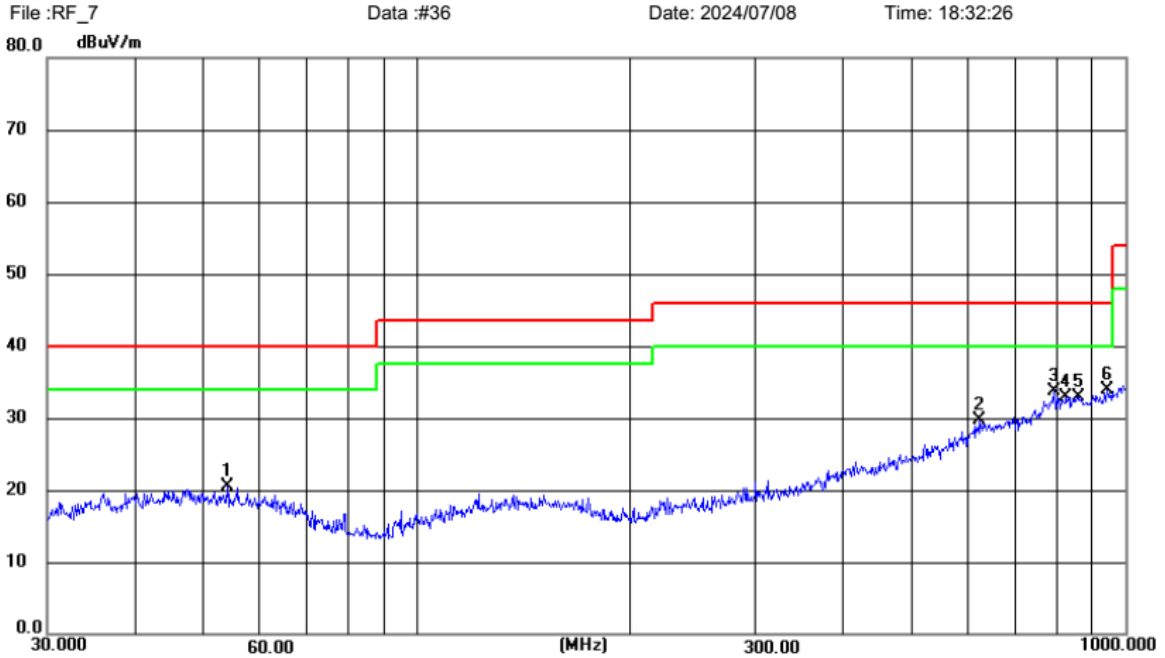

Site LAB Chamber 2 Polarization: **Horizontal** Temperature: 25(C)
 Limit: FCC Part15 RE-Class C_30-1000MHz Power: Humidity: 50 %
 EUT: Distance: 3m
 M/N: WH-4409
 Mode: BLE2M 2402MHz
 Note: GUANGZHOU WEIHAO XUNDA ELECTRONIC CO., LTD

No.	Frequency (MHz)	Reading (dBuV)	Factor (dB/m)	Level (dBuV/m)	Limit (dBuV/m)	Margin (dB)	Detector	Height (cm)	Azimuth (deg.)	P/F	Remark
1	54.0710	6.29	14.23	20.52	40.00	19.48	peak	100	142	P	
2	624.8041	7.30	22.31	29.61	46.00	16.39	peak	100	350	P	
3	793.7438	8.16	25.50	33.66	46.00	12.34	peak	100	329	P	
4	826.7683	6.99	25.89	32.88	46.00	13.12	peak	100	256	P	
5	860.4122	6.62	26.36	32.98	46.00	13.02	peak	100	48	P	
6	942.9567	6.88	27.10	33.98	46.00	12.02	peak	100	256	P	

Vertical



Shenzhen CTL Testing Technology Co., Ltd
Tel: +86-755-89486194

Radiated Emission Measurement

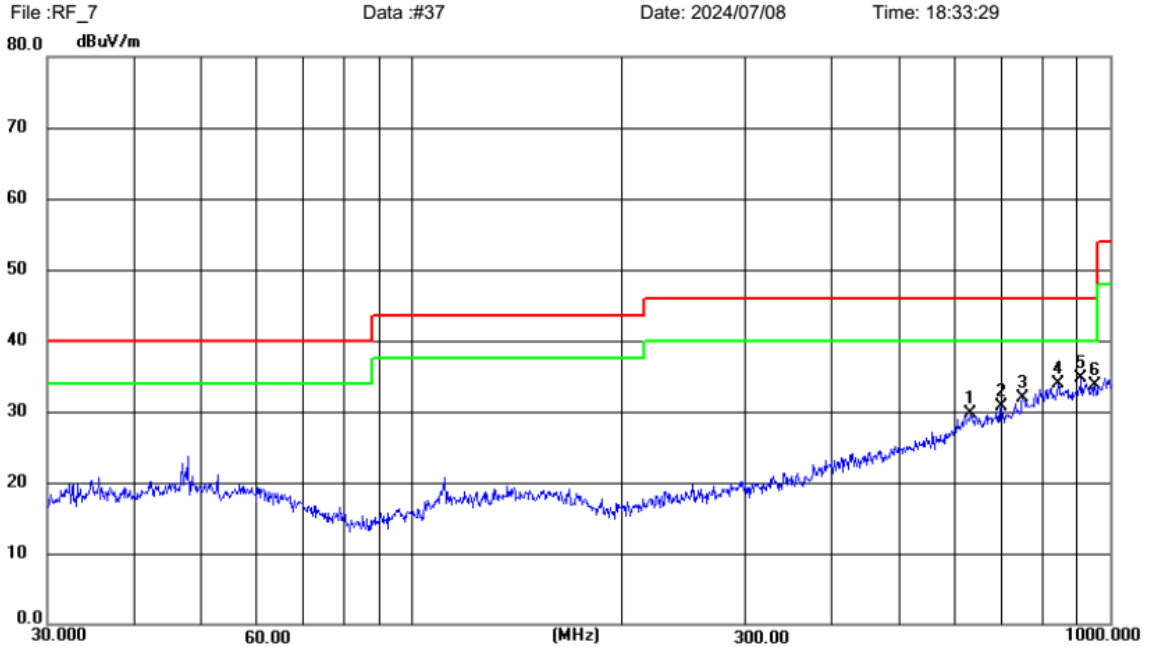

Site LAB Chamber 2 Polarization: **Vertical** Temperature: 25(C)
 Limit: FCC Part15 RE-Class C_30-1000MHz Power: Humidity: 50 %
 EUT: Distance: 3m
 M/N: WH-4409
 Mode: BLE2M 2402MHz
 Note: GUANGZHOU WEIHAO XUNDA ELECTRONIC CO., LTD

No.	Frequency (MHz)	Reading (dBuV)	Factor (dB/m)	Level (dBuV/m)	Limit (dBuV/m)	Margin (dB)	Detector	Height (cm)	Azimuth (deg.)	P/F	Remark
1	630.0293	7.24	22.53	29.77	46.00	16.23	peak	100	114	P	
2	699.6112	8.00	22.76	30.76	46.00	15.24	peak	100	186	P	
3	752.0836	7.34	24.49	31.83	46.00	14.17	peak	100	360	P	
4	843.6074	7.60	26.22	33.82	46.00	12.18	peak	100	342	P	
5	910.0655	8.09	26.64	34.73	46.00	11.27	peak	100	321	P	
6	953.3465	6.63	27.12	33.75	46.00	12.25	peak	100	51	P	

For 1GHz to 18GHz

BLE Mode (above 1GHz)

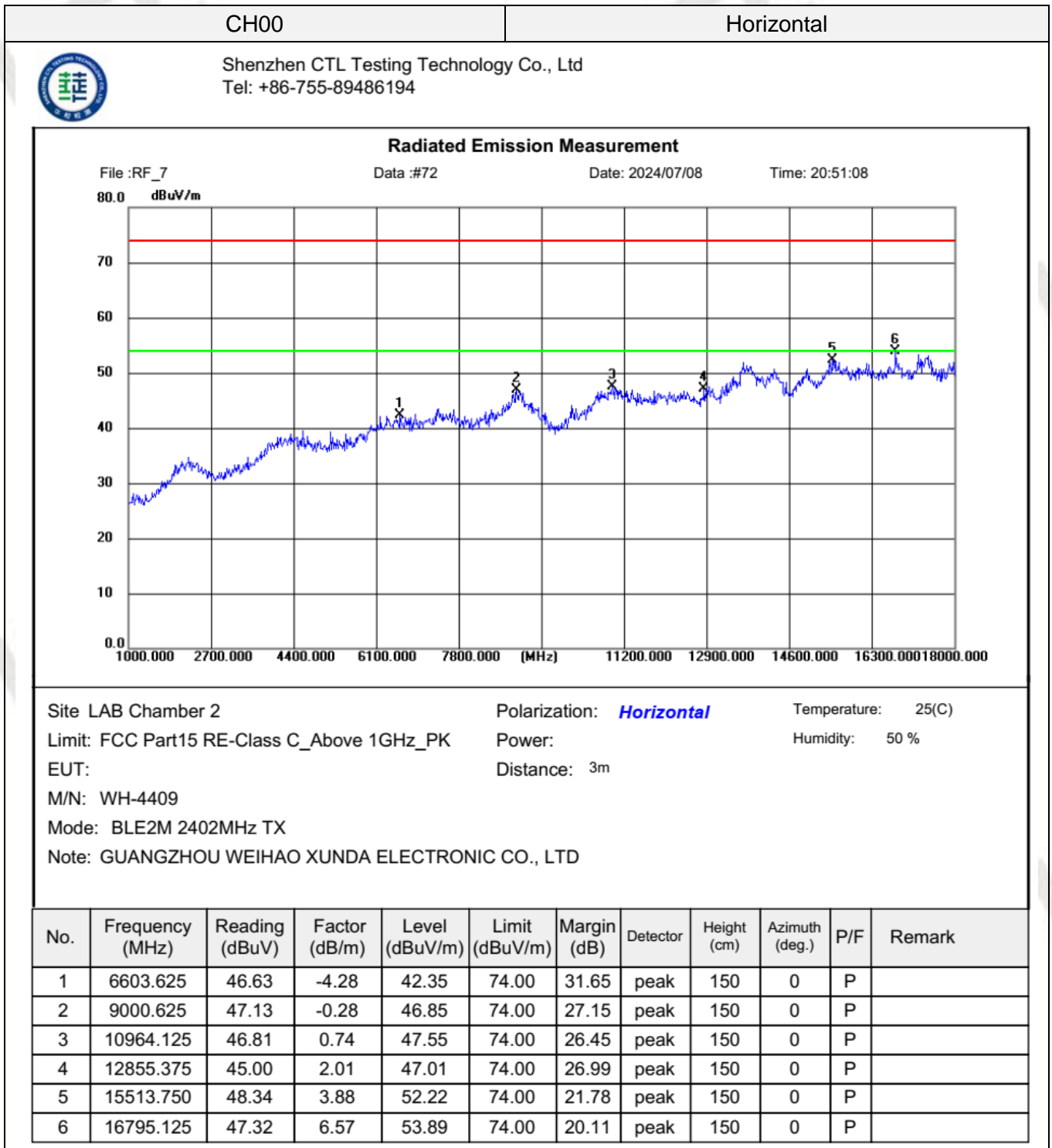

CH00

Vertical



Shenzhen CTL Testing Technology Co., Ltd
Tel: +86-755-89486194

Radiated Emission Measurement

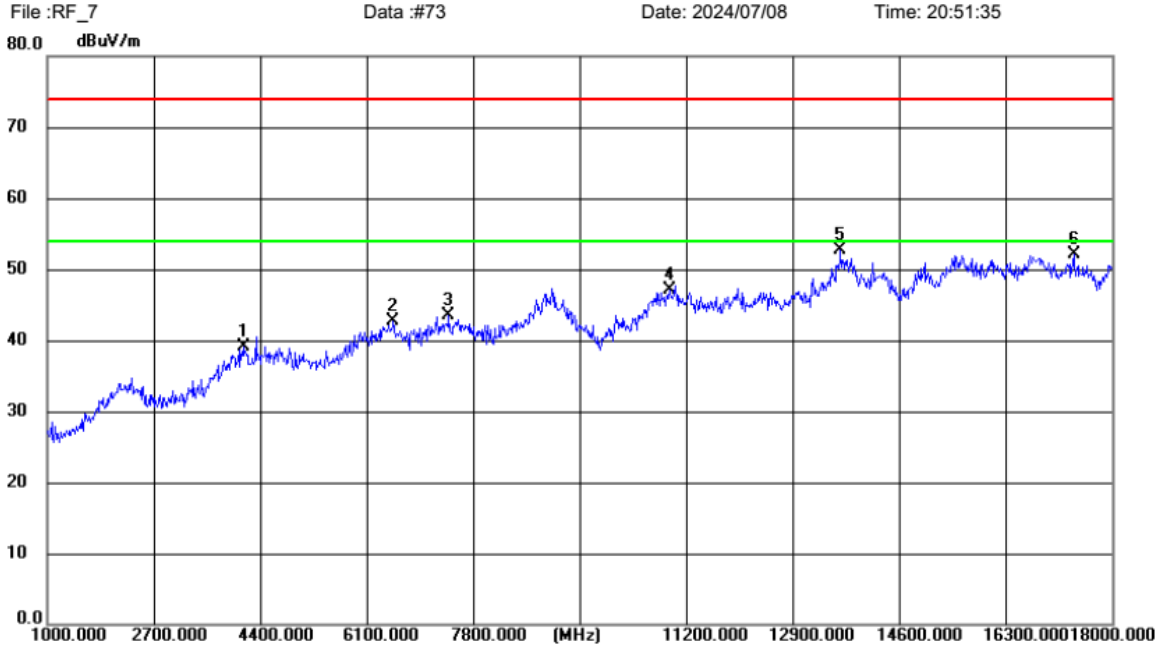

Site LAB Chamber 2 Polarization: **Vertical** Temperature: 25(C)
 Limit: FCC Part15 RE-Class C_Above 1GHz_PK Power: Humidity: 50 %
 EUT: Distance: 3m
 M/N: WH-4409
 Mode: BLE2M 2402MHz TX
 Note: GUANGZHOU WEIHAO XUNDA ELECTRONIC CO., LTD

No.	Frequency (MHz)	Reading (dBuV)	Factor (dB/m)	Level (dBuV/m)	Limit (dBuV/m)	Margin (dB)	Detector	Height (cm)	Azimuth (deg.)	P/F	Remark
1	4140.750	48.91	-9.82	39.09	74.00	34.91	peak	150	0	P	
2	6525.000	46.91	-4.27	42.64	74.00	31.36	peak	150	0	P	
3	7421.750	46.21	-2.80	43.41	74.00	30.59	peak	150	0	P	
4	10936.500	46.35	0.69	47.04	74.00	26.96	peak	150	0	P	
5	13665.000	48.72	3.92	52.64	74.00	21.36	peak	150	0	P	
6	17388.000	43.49	8.69	52.18	74.00	21.82	peak	150	0	P	

CH39

Horizontal



Shenzhen CTL Testing Technology Co., Ltd
Tel: +86-755-89486194

Radiated Emission Measurement

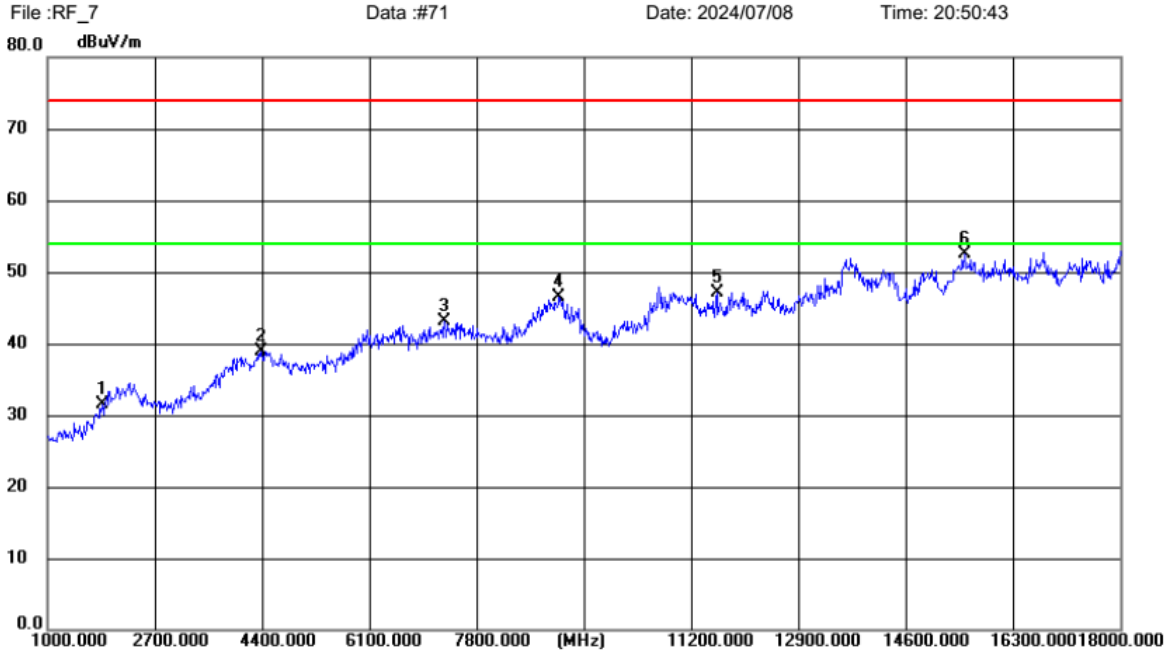

Site LAB Chamber 2 Polarization: **Horizontal** Temperature: 25(C)
 Limit: FCC Part15 RE-Class C_Above 1GHz_PK Power: Humidity: 50 %
 EUT: Distance: 3m
 M/N: WH-4409
 Mode: BLE2M 2440MHz TX
 Note: GUANGZHOU WEIHAO XUNDA ELECTRONIC CO., LTD

No.	Frequency (MHz)	Reading (dBuV)	Factor (dB/m)	Level (dBuV/m)	Limit (dBuV/m)	Margin (dB)	Detector	Height (cm)	Azimuth (deg.)	P/F	Remark
1	1871.250	51.11	-19.57	31.54	74.00	42.46	peak	150	0	P	
2	4395.750	47.58	-8.72	38.86	74.00	35.14	peak	150	0	P	
3	7304.875	46.07	-3.03	43.04	74.00	30.96	peak	150	0	P	
4	9109.000	46.65	-0.17	46.48	74.00	27.52	peak	150	0	P	
5	11610.125	45.98	1.10	47.08	74.00	26.92	peak	150	0	P	
6	15535.000	48.53	3.88	52.41	74.00	21.59	peak	150	0	P	

CH39

Vertical



Shenzhen CTL Testing Technology Co., Ltd
Tel: +86-755-89486194

Radiated Emission Measurement

File :RF_7 Data :#70 Date: 2024/07/08 Time: 20:50:21

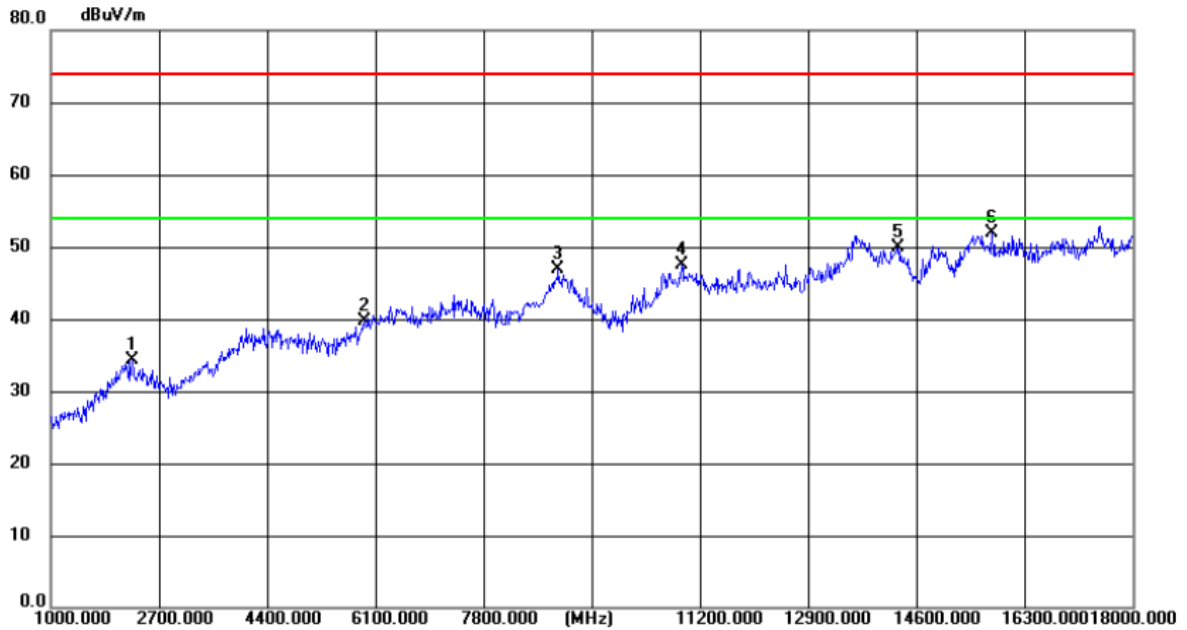

Site LAB Chamber 2 Polarization: **Vertical** Temperature: 25(C)
 Limit: FCC Part15 RE-Class C_Above 1GHz_PK Power: Humidity: 50 %
 EUT: Distance: 3m
 M/N: WH-4409
 Mode: BLE2M 2440MHz TX
 Note: GUANGZHOU WEIHAO XUNDA ELECTRONIC CO., LTD

No.	Frequency (MHz)	Reading (dBuV)	Factor (dB/m)	Level (dBuV/m)	Limit (dBuV/m)	Margin (dB)	Detector	Height (cm)	Azimuth (deg.)	P/F	Remark
1	2275.000	51.55	-17.32	34.23	74.00	39.77	peak	150	0	P	
2	5944.875	45.55	-5.84	39.71	74.00	34.29	peak	150	0	P	
3	8973.000	47.34	-0.35	46.99	74.00	27.01	peak	150	0	P	
4	10915.250	46.82	0.66	47.48	74.00	26.52	peak	150	0	P	
5	14317.375	47.12	2.78	49.90	74.00	24.10	peak	150	0	P	
6	15798.500	47.66	4.20	51.86	74.00	22.14	peak	150	0	P	

CH78

Horizontal



Shenzhen CTL Testing Technology Co., Ltd
Tel: +86-755-89486194

Radiated Emission Measurement

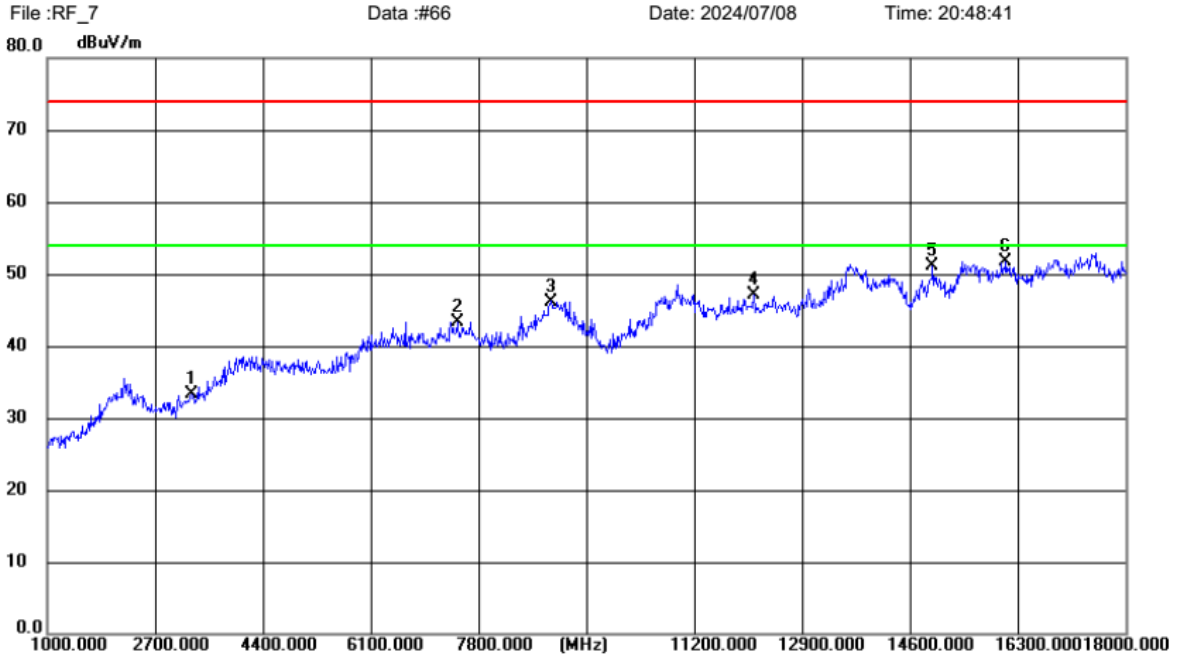

Site LAB Chamber 2 Polarization: **Horizontal** Temperature: 25(C)
 Limit: FCC Part15 RE-Class C_Above 1GHz_PK Power: Humidity: 50 %
 EUT: Distance: 3m
 M/N: WH-4409
 Mode: BLE2M 2480MHz TX
 Note: GUANGZHOU WEIHAO XUNDA ELECTRONIC CO., LTD

No.	Frequency (MHz)	Reading (dBuV)	Factor (dB/m)	Level (dBuV/m)	Limit (dBuV/m)	Margin (dB)	Detector	Height (cm)	Azimuth (deg.)	P/F	Remark
1	3282.250	46.17	-12.81	33.36	74.00	40.64	peak	150	0	P	
2	7468.500	46.10	-2.78	43.32	74.00	30.68	peak	150	0	P	
3	8947.500	46.62	-0.42	46.20	74.00	27.80	peak	150	0	P	
4	12149.875	44.84	2.19	47.03	74.00	26.97	peak	150	0	P	
5	14965.500	47.85	3.26	51.11	74.00	22.89	peak	150	0	P	
6	16117.250	46.76	5.00	51.76	74.00	22.24	peak	150	0	P	

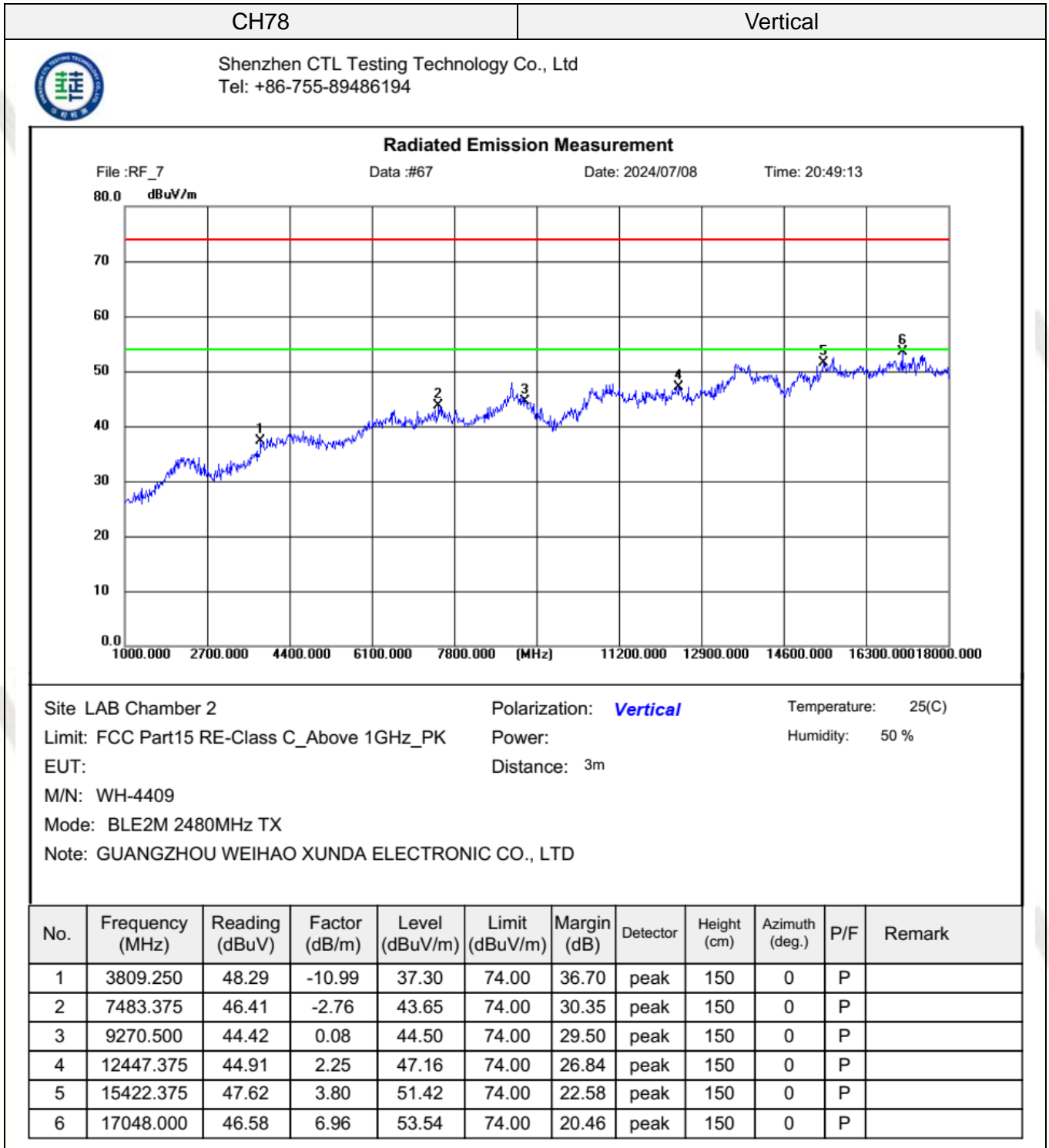

REMARKS:

1. Emission level (dBuV/m) =Raw Value (dBuV)+Correction Factor (dB/m)
2. Correction Factor (dB/m) = Antenna Factor (dB/m)+Cable Factor (dB)-Pre-amplifier Factor
3. Margin value = Limit value- Emission level.
4. -- Mean the PK detector measured value is below average limit.
5. RBW1MHz VBW3MHz Peak detector is for PK value; RBW 1MHz VBW10Hz Peak detector is for AV value.
6. Other emissions are attenuated 20dB below the limits from 9kHz to 30MHz, so it does not recorded in report.
7. 18GHz-26GHz not recorded for no spurious point have a margin of less than 6 dB with respect to the limits.

Results of Band Edges Test (Radiated)

Frequency(MHz):			2402		Polarity:			HORIZONTAL	
Frequency (MHz)	Emission Level (dBuV/m)		Limit (dBuV/m)	Margin (dB)	Raw Value (dBuV)	Antenna Factor (dB/m)	Cable Factor (dB)	Pre-amplifier (dB)	Correction Factor (dB/m)
2402.00	98.75	PK	--	--	65.36	28.78	4.61	0.00	33.39
2402.00	81.15	AV	--	--	47.76	28.78	4.61	0.00	33.39
2351.00	44.27	PK	74.00	29.73	11.19	28.52	4.56	0.00	33.08
2351.00	--	AV	54.00	--	--	--	--	--	--
2390.00	44.36	PK	74.00	29.64	11.04	28.72	4.60	0.00	33.32
2390.00	--	AV	54.00	--	--	--	--	--	--
2400.00	44.56	PK	--	--	11.17	28.78	4.61	0.00	33.39
2400.00	--	AV	--	--	--	--	--	--	--

Frequency(MHz):			2402		Polarity:			VERTICAL	
Frequency (MHz)	Emission Level (dBuV/m)		Limit (dBuV/m)	Margin (dB)	Raw Value (dBuV)	Antenna Factor (dB/m)	Cable Factor (dB)	Pre-amplifier (dB)	Correction Factor (dB/m)
2402.00	106.63	PK	--	--	73.24	28.78	4.61	0.00	33.39
2402.00	90.16	AV	--	--	56.77	28.78	4.61	0.00	33.39
2369.00	46.31	PK	74.00	27.69	13.23	28.52	4.56	0.00	33.08
2369.00	--	AV	54.00	--	--	--	--	--	--
2390.00	43.86	PK	74.00	30.14	10.54	28.72	4.60	0.00	33.32
2390.00	--	AV	54.00	--	--	--	--	--	--
2400.00	45.13	PK	--	--	11.74	28.78	4.61	0.00	33.39
2400.00	--	AV	--	--	--	--	--	--	--

Frequency(MHz):			2480		Polarity:			HORIZONTAL	
Frequency (MHz)	Emission Level (dBuV/m)		Limit (dBuV/m)	Margin (dB)	Raw Value (dBuV)	Antenna Factor (dB/m)	Cable Factor (dB)	Pre-amplifier (dB)	Correction Factor (dB/m)
2480.00	105.51	PK	--	--	71.89	28.92	4.70	0.00	33.62
2480.00	91.88	AV	--	--	58.26	28.92	4.70	0.00	33.62
2483.50	46.19	PK	74.00	27.81	12.56	28.93	4.70	0.00	33.63
2483.50	--	AV	54.00	--	--	--	--	--	--
2486.00	43.74	PK	74.00	30.26	10.08	28.95	4.71	0.00	33.66
2486.00	--	AV	54.00	--	--	--	--	--	--
2500.00	45.18	PK	74.00	28.82	11.5	28.96	4.72	0.00	33.68
2500.00	--	AV	54.00	--	--	--	--	--	--

Frequency(MHz):			2480		Polarity:			VERTICAL	
Frequency (MHz)	Emission Level (dBuV/m)		Limit (dBuV/m)	Margin (dB)	Raw Value (dBuV)	Antenna Factor (dB/m)	Cable Factor (dB)	Pre-amplifier (dB)	Correction Factor (dB/m)
2480.00	104.52	PK	--	--	70.9	28.92	4.70	0.00	33.62
2480.00	89.43	AV	--	--	55.81	28.92	4.70	0.00	33.62
2483.50	45.21	PK	74.00	28.79	11.58	28.93	4.70	0.00	33.63
2483.50	--	AV	54.00	--	--	--	--	--	--
2493.00	42.64	PK	74.00	31.36	8.98	28.95	4.71	0.00	33.66
2493.00	--	AV	54.00	--	--	--	--	--	--
2500.00	44.36	PK	74.00	29.64	10.68	28.96	4.72	0.00	33.68
2500.00	--	AV	54.00	--	--	--	--	--	--

REMARKS:

1. Emission level (dBuV/m) =Raw Value (dBuV)+Correction Factor (dB/m)
2. Correction Factor (dB/m) = Antenna Factor (dB/m)+Cable Factor (dB)-Pre-amplifier Factor
3. Margin value = Limit value- Emission level.
4. -- Mean the PK detector measured value is below average limit.
5. RBW1MHz VBW3MHz Peak detector is for PK value; RBW 1MHz VBW10Hz Peak detector is for AV value.
6. For fundamental frequency, RBW 3MHz VBW 3MHz Peak detector is for PK Value; RMS detector is for AV value.
7. Other emissions are attenuated 20dB below the limits from 9kHz to 30MHz, so it does not recorded in report.

3.3. Maximum Conducted Output Power

Limit

The Maximum Peak Output Power Measurement is 30dBm.

Test Procedure

Remove the antenna from the EUT and then connect a low loss RF cable from the antenna port to the spectrum.

Test Configuration



Test Results

Raw data reference to Appendix Test Data for Bluetooth LE Section 2.

3.4. Power Spectral Density

Limit

For digitally modulated systems, the power spectral density conducted from the intentional radiator to the antenna shall not be greater than 8 dBm in any 3 kHz band during any time interval of continuous transmission.

Test Procedure

1. Use this procedure when the maximum peak conducted output power in the fundamental emission is used to demonstrate compliance.
2. Set the RBW \geq 3 kHz.
3. Set the VBW \geq 3 \times RBW.
4. Set the span to 1.5 times the DTS channel bandwidth.
5. Detector = peak.
6. Sweep time = auto couple.
7. Trace mode = max hold.
8. Allow trace to fully stabilize.
9. Use the peak marker function to determine the maximum power level.
10. If measured value exceeds limit, reduce RBW (no less than 3 kHz) and repeat.
11. The resulting peak PSD level must be 8dBm.

Test Configuration

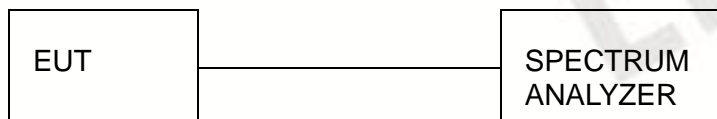

Test Results

Raw data reference to Appendix Test Data for Bluetooth LE Section 3.

3.5. 6dB Bandwidth

Limit

For digital modulation systems, the minimum 6 dB bandwidth shall be at least 500 kHz

Test Procedure

The transmitter output was connected to the spectrum analyzer through an attenuator. The bandwidth of the fundamental frequency was measured by spectrum analyzer with 100 KHz RBW and 300 KHz VBW. The 6dB bandwidth is defined as the total spectrum the power of which is higher than peak power minus 6dB.

Test Configuration



Test Results

Raw data reference to Appendix Test Data for Bluetooth LE Section 1.

3.6. Out-of-band Emissions

Limit

In any 100 kHz bandwidth outside the frequency band in which the spread spectrum or digitally modulated intentional radiator is operating, the radio frequency power that is produced by the intentional radiator shall be at least 20 dB below that in the 100 kHz bandwidth within the band that contains the highest level of the desired power, based on either an RF conducted or a radiated measurement, provided the transmitter demonstrates compliance with the peak conducted power limits. If the transmitter complies with the conducted power limits based on the use of RMS averaging over a time interval, as permitted under paragraph (b)(3) of this section, the attenuation required under this paragraph shall be 30 dB instead of 20 dB. Attenuation below the general limits specified in §15.209(a) is not required.

Test Procedure

Connect the transmitter output to spectrum analyzer using a low loss RF cable, and set the spectrum analyzer to RBW=100 kHz, VBW= 300 kHz, peak detector, and max hold. Measurements utilizing these settings are made of the in-band reference level, band edge and out-of-band emissions.

Test Configuration

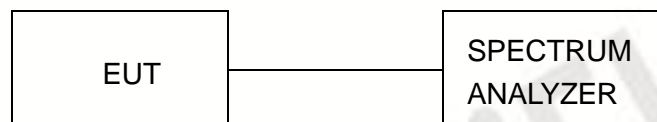

Test Results

Raw data reference to Appendix Test Data for Bluetooth LE Section 4.

3.7. Antenna Requirement

Standard Applicable

For intentional device, according to FCC 47 CFR Section 15.203:

An intentional radiator shall be designed to ensure that no antenna other than that furnished by the responsible party shall be used with the device. The use of a permanently attached antenna or of an antenna that uses a unique coupling to the intentional radiator, the manufacturer may design the unit so that a broken antenna can be replaced by the user, but the use of a standard antenna jack or electrical connector is prohibited

FCC CFR Title 47 Part 15 Subpart C Section 15.247(c) (1) (I):

(i) Systems operating in the 2400-2483.5 MHz band that is used exclusively for fixed. Point-to-point operations may employ transmitting antennas with directional gain greater than 6dBi provided the maximum conducted output power of the intentional radiator is reduced by 1 dB for every 3 dB that the directional gain of the antenna exceeds 6dBi.

Test Result:

The maximum gain of antenna was 1.7 dBi



BT Antenna

4. Test Setup Photos of the EUT

Reference to the test report No. CTL2406241011-WF01

5. External and Internal Photos of the EUT

Reference to the test report No. CTL2406241011-WF01.

***** End of Report *****