

产品规格承认书

SPECIFICATIONS

客户:

CUSTOMER: _____

产品名称:

DESCRIPTION: _____ 蓝牙天线 _____

客户型号:

CUSTOMER PART No: _____

产品型号:

OUR MODEL NO: _____ PBX2012MA02 _____

日期:

DATE: _____ 2020/12/22 _____

确认签字, 盖章后请返回承认书一份

PLEASE RETURN TO US ONE COPY OF "SPECIFICATION FOR APPROVAL" WITH YOUR APPROVED SIGNATURES

核准	王海	审核	刘飞	制作	刘小美
----	----	----	----	----	-----

客户确认签章 (APPROVED SIGNATURE)			

PBX2012MA02 Specification

Operating Temp. : -40°C~+85°C

1. FEATURES:

- Light weight, compact
- Wide bandwidth, low cost
- Built-in antenna with high gain

2. APPLICATIONS:

- Bluetooth, Wireless LAN, Mobile TV
- Home RF System, etc

3. PRODUCT IDENTIFICATION

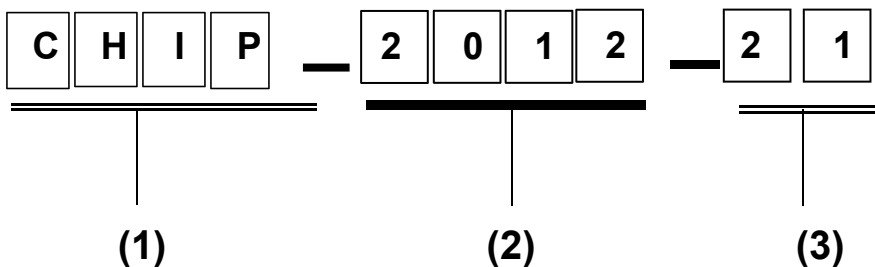

- (1) Product type: Multilayer chip Antenna
- (2) External Dimensions (L×W) (mm): 2.0*1.2

4. SHAPE AND DIMENSIONS:

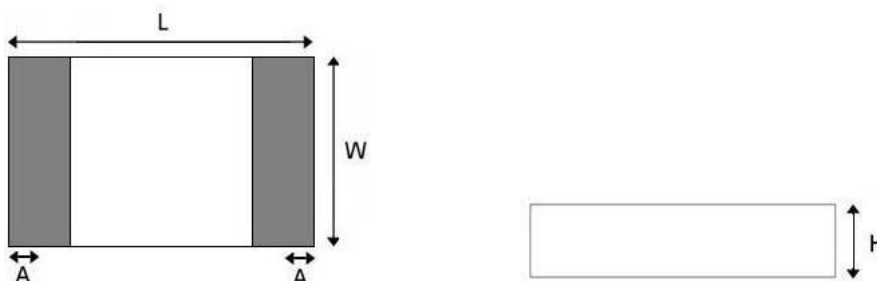

SHAPE AND DIMENSIONS

L	W	H	A
2.0±0.2	1.2±0.2	0.55±0.1	0.4±0.1

UNLESS OTHER SPECIFIED TOLERANCES ON: X=± X.X=± X.XX= ANGLES =± HOLEDIA =±		 深圳市朋伴兴业科技有限公司 PENG BAN XING		
SCALE: N/A	UNIT: mm	THIS DRAWINGS AND SPECIFICATIONS ARE THE PROPERTY OF PBXY TECHNOLOGY Limited AND SHALL NOT BE REPRODUCED OR USED AS THE BASIS FOR THE MANUFACTURE OR SALE OF APPARATUS OR DEVICES WITHOUT PERMISSION		
DRAWN BY : Sera	CHECKED BY: XD			
DESIGNED BY: Sera	APPROVED BY: XD			
TITLE: CHIP2450-21 Specification		DOCUMENT NO.	2012	SPEC REV. P1

TERMINAL-CONFIGURATION



EVALUATION BOARD

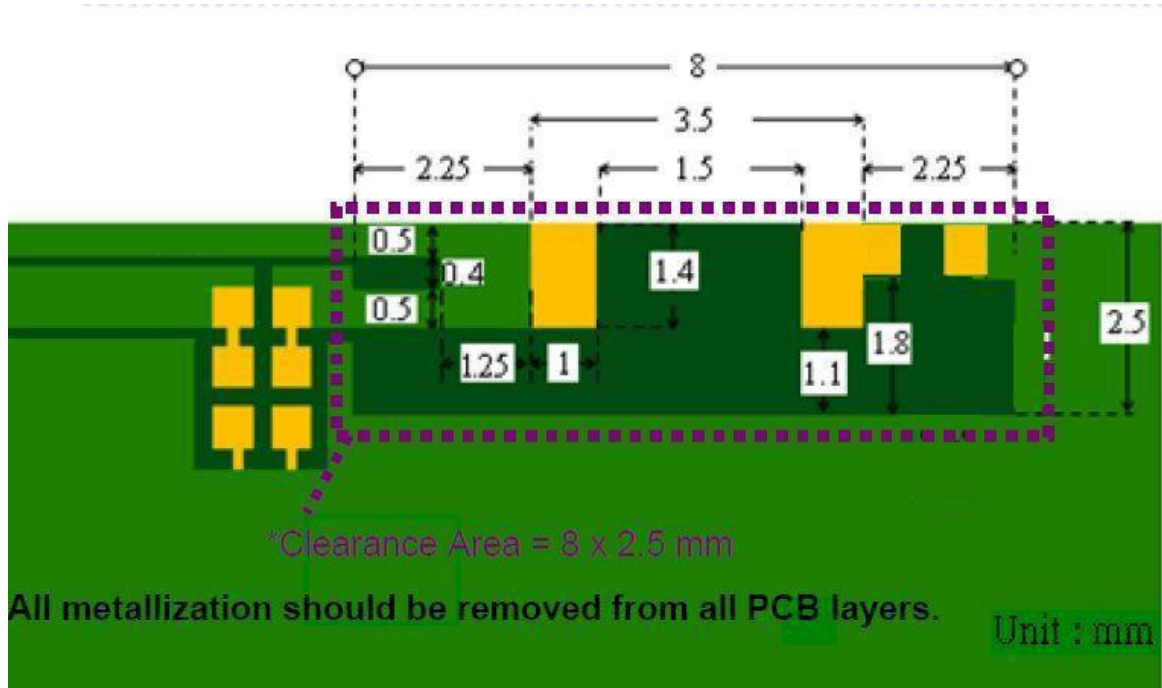

APPLICATION GUIDE

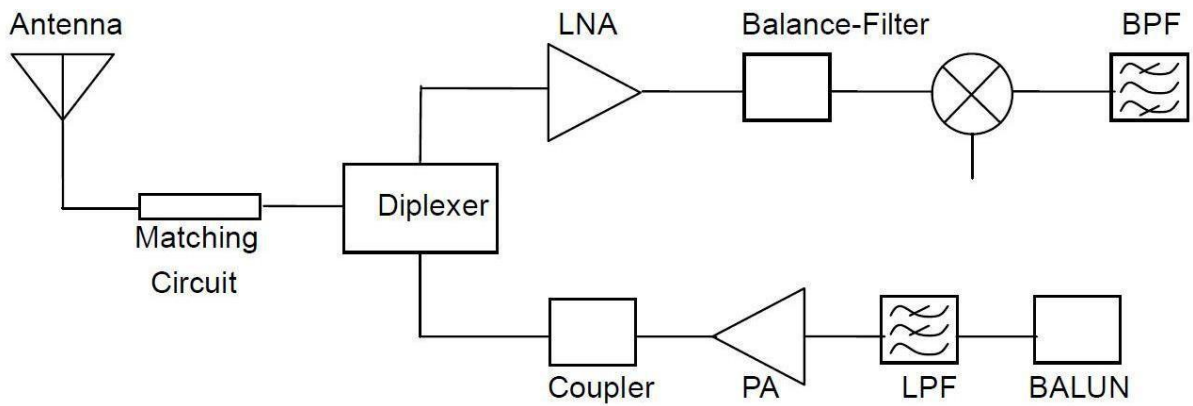

UNLESS OTHER SPECIFIED TOLERANCES ON: X=± X.X=± X.XX= ANGLES =± HOLEDIA =±		 深圳市朋伴兴业科技有限公司 <small>PENGBANKING</small>		
SCALE: N/A	UNIT: mm	THIS DRAWINGS AND SPECIFICATIONS ARE THE PROPERTY OF PBXY TECHNOLOGY Limited AND SHALL NOT BE REPRODUCED OR USED AS THE BASIS FOR THE MANUFACTURE OR SALE OF APPARATUS OR DEVICES WITHOUT PERMISSION		
DRAWN BY : Sera	CHECKED BY: XD			
DESIGNED BY: Sera	APPROVED BY: XD			
TITLE: CHIP2450-21 Specification		DOCUMENT NO.	2012	SPEC REV. P1

5. SPECIFICATIONS:

ITEM	SPECIFICATION
Frequency Band	2400MHz~2483MHz
VSWR	Less than 3
Polarization	Linear
*Peak Gain	2.48 dBi Typ.
*Peak Efficiency	72.6% Typ.
Impedance	50 Ω Typ.

* Test condition: Test board size 98*65 mm

Matching circuit: Pi matching circuit will be required

6. Electrical Characteristics :

VSWR

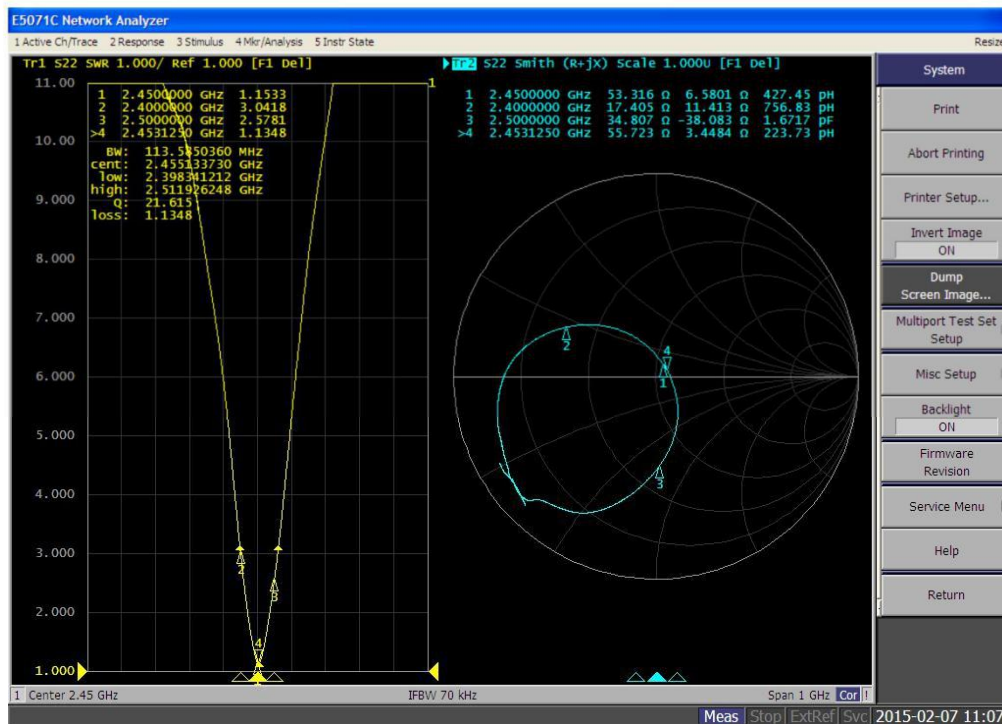

Mark	Frequency	VSWR
1	2400 MHz	3.04
2	2450 MHz	1.15
3	2500 MHz	2.57

UNLESS OTHER SPECIFIED TOLERANCES ON:

X=± X.X=± X.XX=
 ANGLES =± HOLEDIA =±



深圳市朋伴兴业科技有限公司

SCALE: N/A

UNIT: mm

DRAWN BY : Sera

CHECKED BY: XD

DESIGNED BY: Sera

APPROVED BY: XD

THIS DRAWINGS AND SPECIFICATIONS ARE THE PROPERTY OF PBXY TECHNOLOGY Limited AND SHALL NOT BE REPRODUCED OR USED AS THE BASIS FOR THE MANUFACTURE OR SALE OF APPARATUS OR DEVICES WITHOUT PERMISSION

TITLE: CHIP2450-21 Specification

DOCUMENT NO.

2012

SPEC REV.
P1

Radiation Pattern

The Gain pattern is measured in INPAQ's FAR-field chamber. DUT is placed on the table of rotator, a standard horn antenna and Vector Network Analyzer is used to collect data.

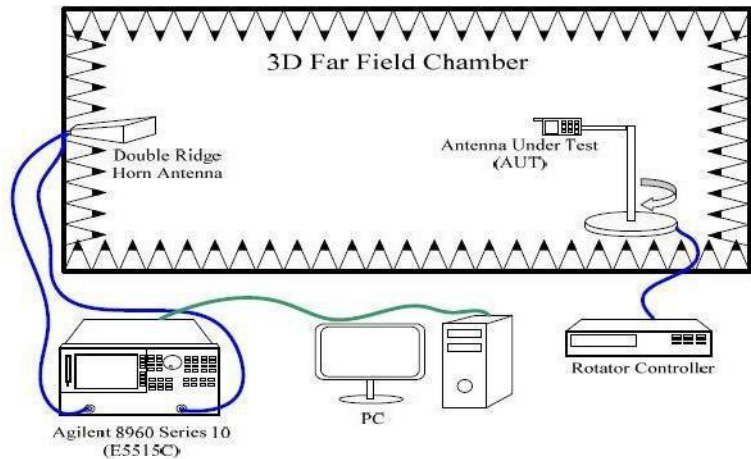
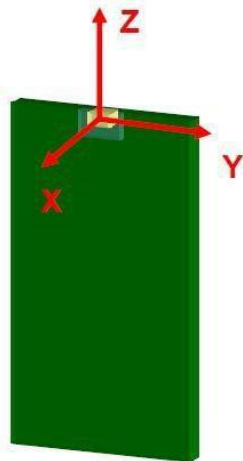

◎ 3D Gain Pattern (2400 MHz)

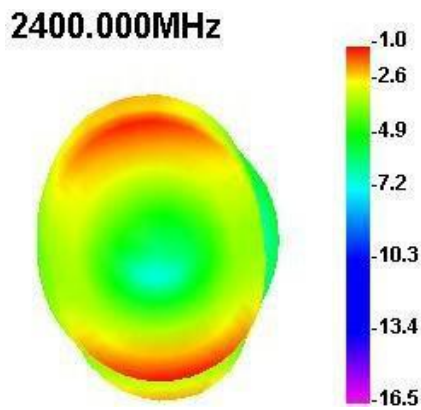

◎ 2D Gain Pattern (2400 MHz)

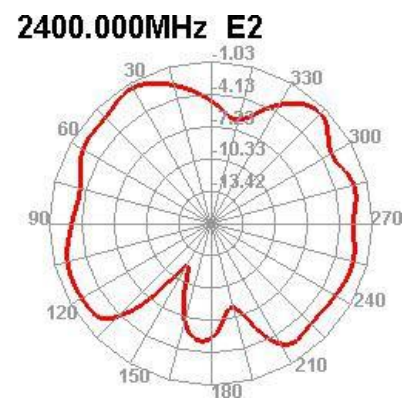
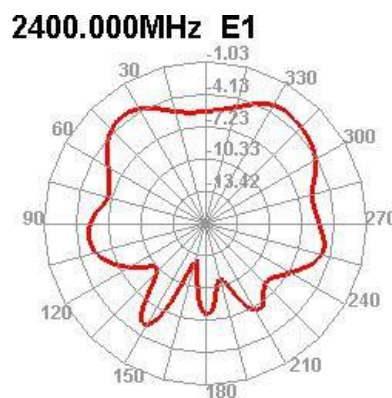
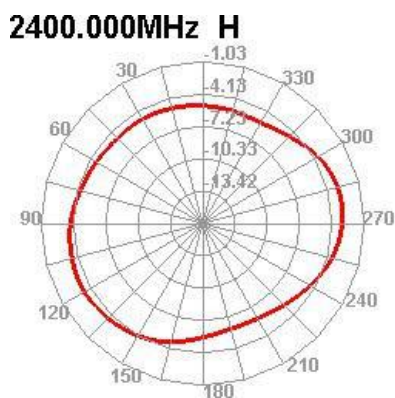

UNLESS OTHER SPECIFIED TOLERANCES ON: X=± X.X=± X.XX=± ANGLES=± HOLEDIA=±		 深圳市朋伴兴业科技有限公司		
SCALE: N/A	UNIT: mm	THIS DRAWINGS AND SPECIFICATIONS ARE THE PROPERTY OF PBXY TECHNOLOGY Limited AND SHALL NOT BE REPRODUCED OR USED AS THE BASIS FOR THE MANUFACTURE OR SALE OF APPARATUS OR DEVICES WITHOUT PERMISSION		
DRAWN BY : Sera	CHECKED BY: XD			
DESIGNED BY: Sera	APPROVED BY: XD			
TITLE: CHIP2450-21 Specification		DOCUMENT NO.	2012	SPEC REV. P1