



ISM 868 / 915 MHz ANTENNA

Part Numbers: 2195835-1~-8

FEATURES & BENEFITS

- ISM antenna, including of 868 / 915 ISM and IoT products
- Available cable lengths: 50,100,150,200 mm, custom specific (Different cable lengths having impact on RF performance, see individual RF data)
- Available connectors: MHF, MHF4 or compatible, custom specific
- FPC with double side adhesive tape simplifies mounting within the device even on curved areas
- Omnidirectional coverage

SPECIFICATIONS

P/N	2195835-1/-2/-3/-5/-6/-7	2195835-4/-8
Frequency Range (MHz)	863-928	863-928
VSWR	< 2.3:1	< 2.3:1
Average Efficiency	35%	47%
Peak Gain	1.4dBi	-0.9dBi
Average Gain	-4.5dB	-3.2dB
Power Handling	10 Watt cw	
Feed Point Impedance	50 ohms unbalanced	
Polarization	Linear	
Size	38 mm x 9.0 mm x 0.2 mm	
Weight	< 0.9 g	
Mounting	Adhesive flexible tape	
Mating Connectors	MHF type receptacle (TE PN 2337019-1), MHF4 type receptacle (TE PN: 2334884-1)	
Operating Temperature	-40 to +85°C	
Storage Temperature	-40 to +85°C	
Hazardous Materials	A certificate of conformance is available from the product page on TE website.	

RF DATA \leq 150 mm cable length

VSWR

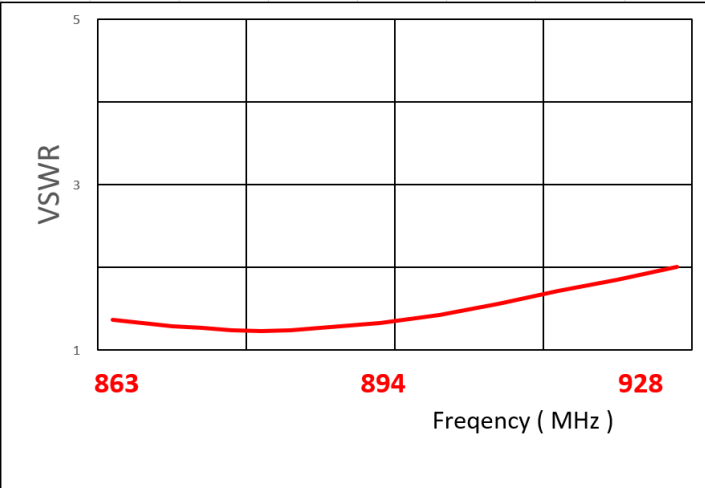

Return Loss

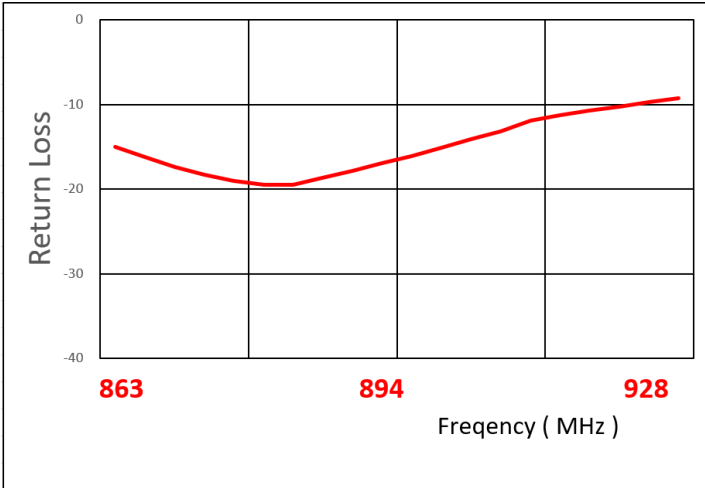

Efficiency

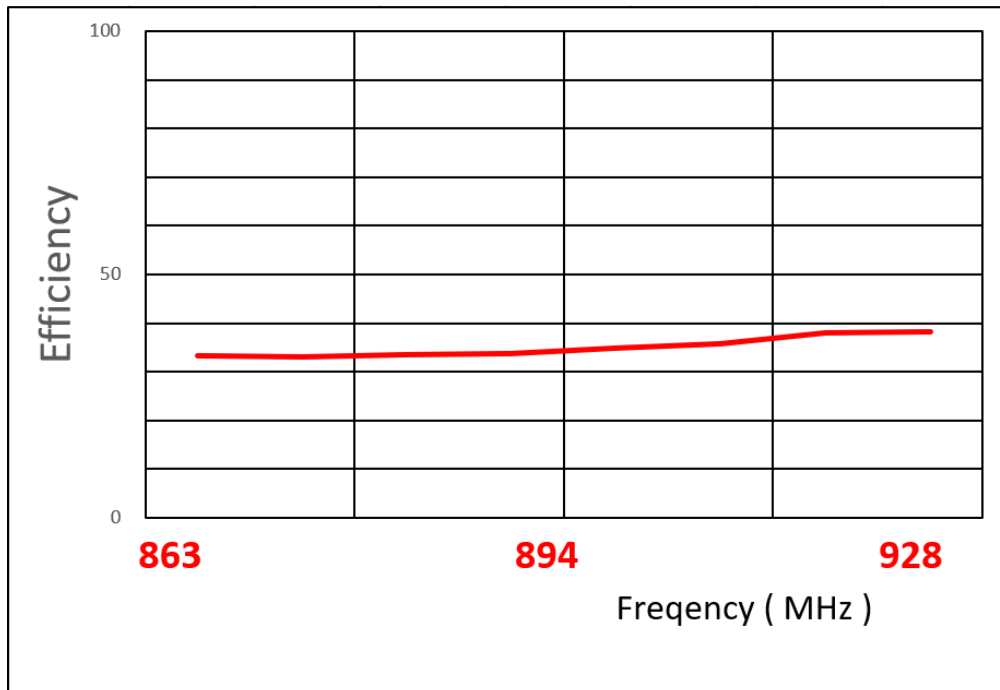

P/N : 2195835-1/-2/-3/-5/-6/-7

Data measured in free space and on plastic device enclosure

RADIATION PATTERN ≤ 150 mm cable length

Test setup

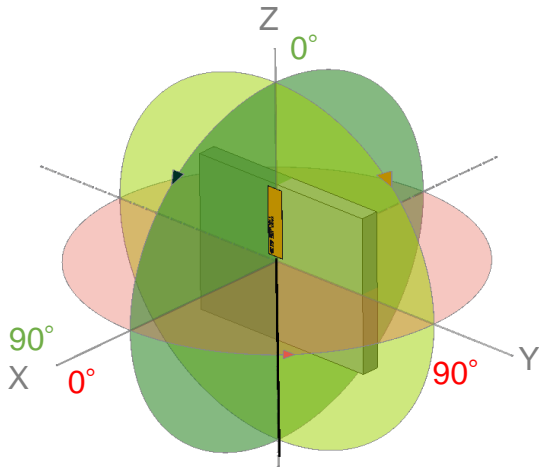

Azimuth Plane
Elevation 1 Plane
Elevation 2 Plane

Azimuth

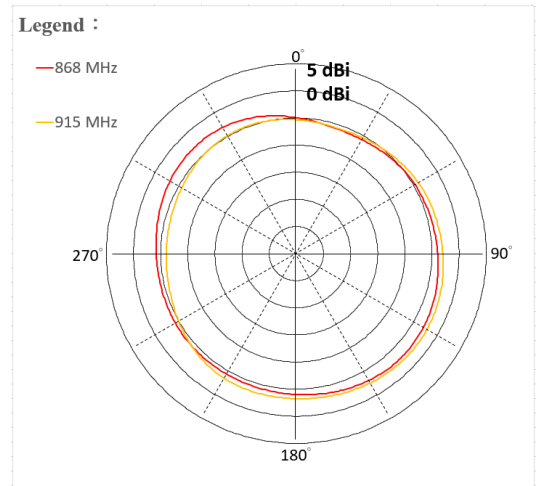

Elevation 1

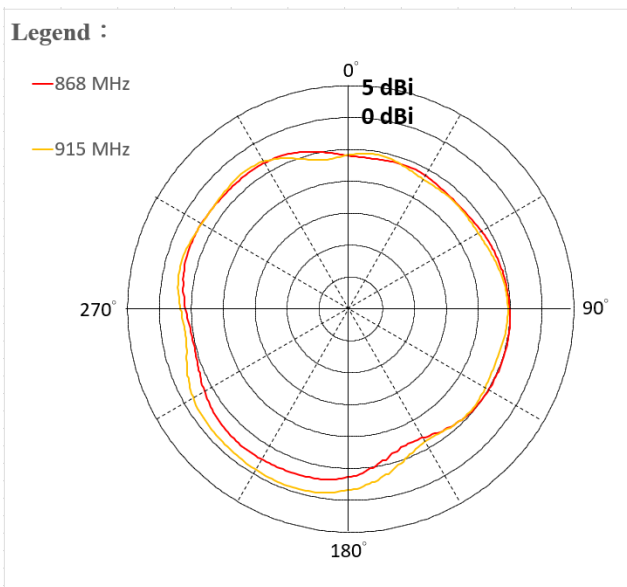

Elevation 2

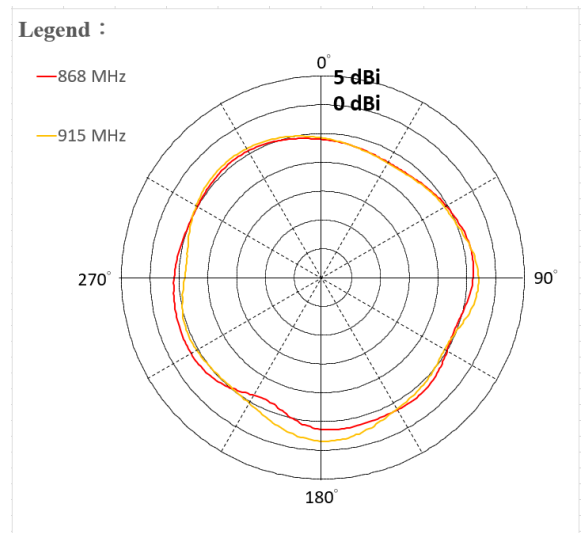

P/N : 2195835-1/-2/-3/-5/-6/-7

Data measured in free space and on plastic device enclosure

RF DATA for 200 mm cable length

VSWR

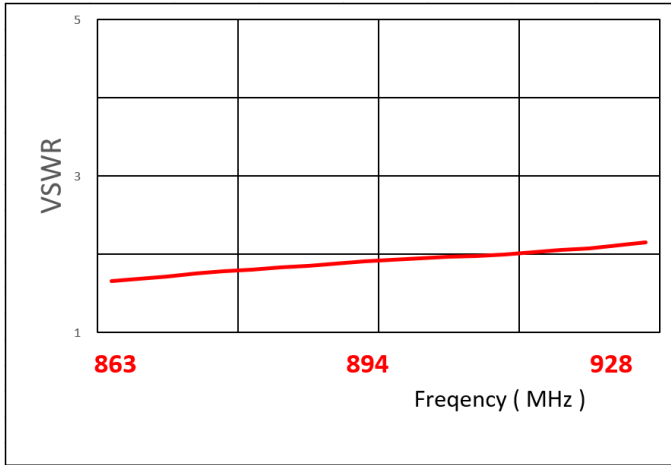

Return Loss

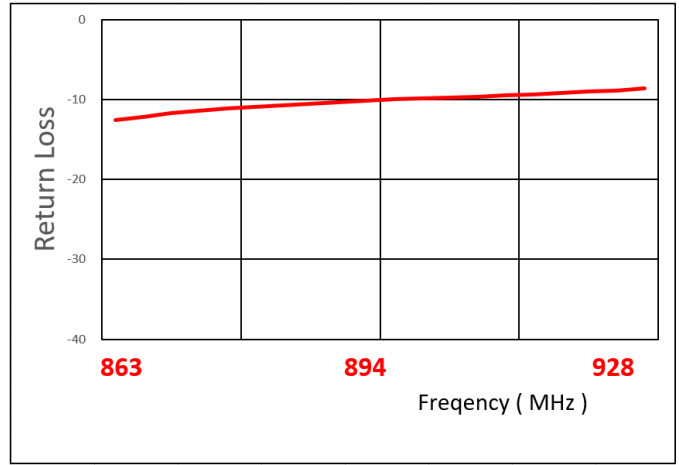

Efficiency

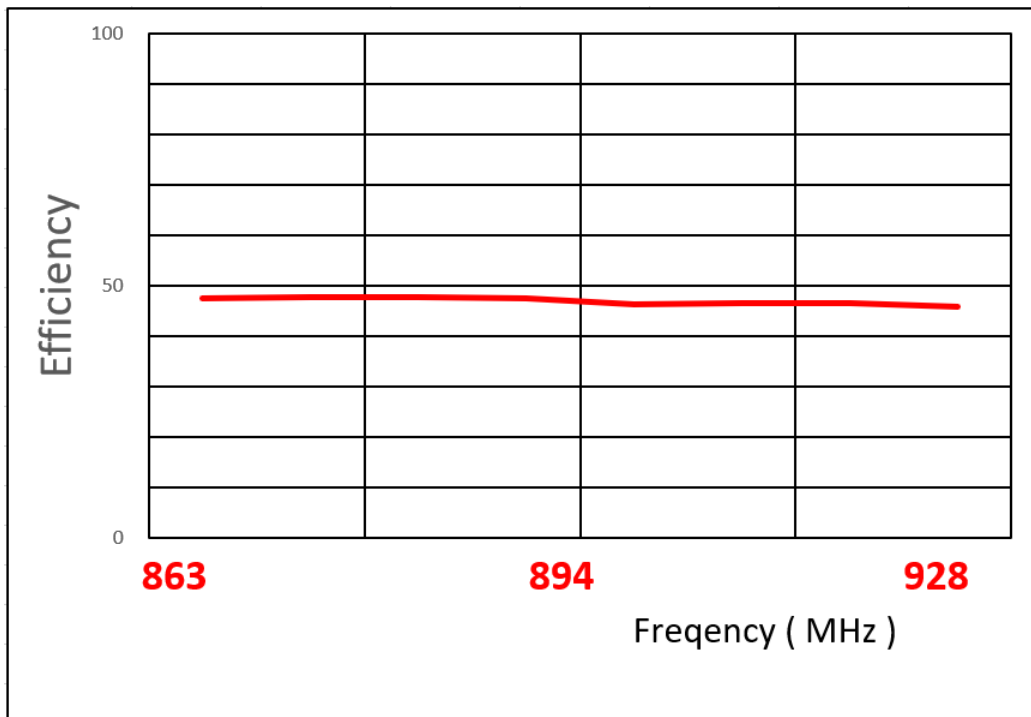

P/N : 2195835-4/-8

Data measured in free space and on plastic device enclosure

RADIATION PATTERN for 200 mm cable length

Test setup

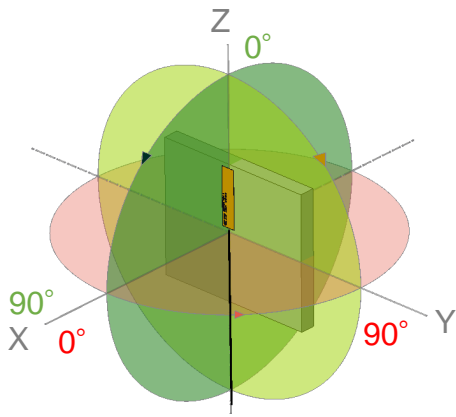

Azimuth Plane
Elevation 1 Plane
Elevation 2 Plane

Azimuth

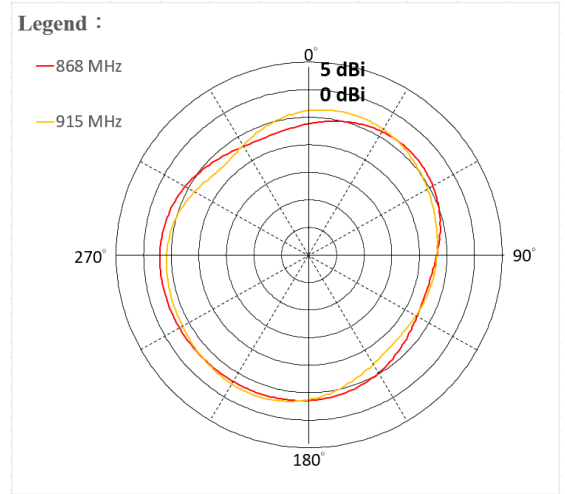

Elevation 1

Elevation 2

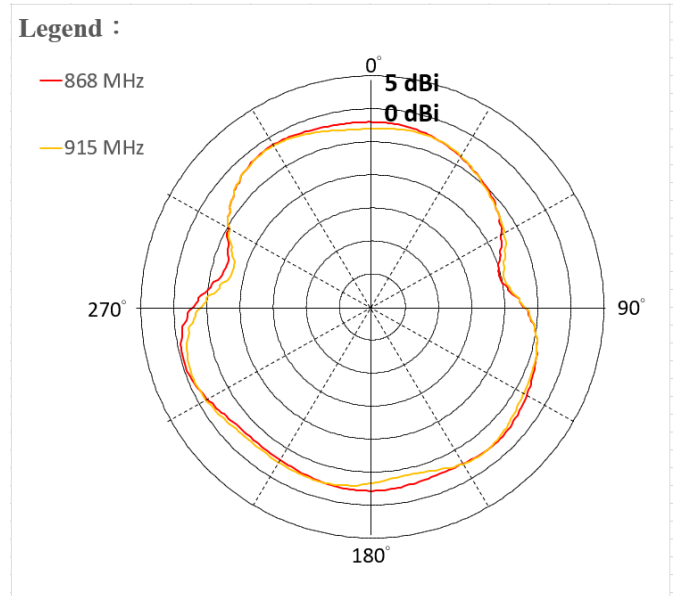
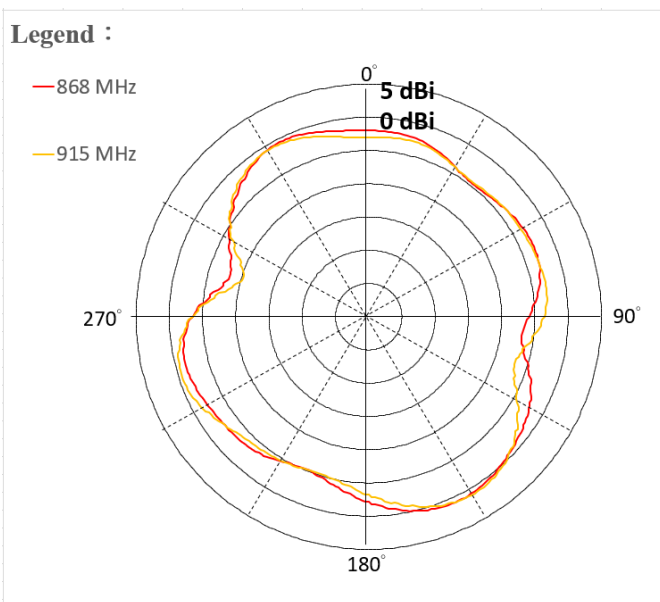

P/N : 2195835-4/-8

Data measured in free space and on plastic device enclosure

ISM 868 / 915 MHz ANTENNA

Standard Antenna Solutions

KEEP OUT AREA

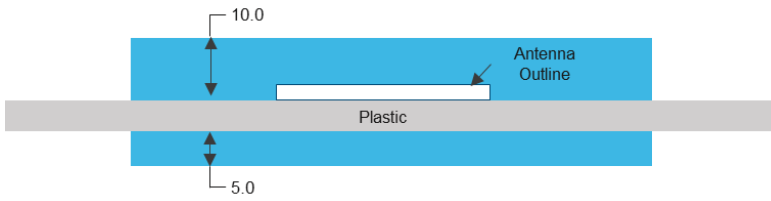

NOTES

1. Antenna designed to be mounted on plastic cover.
2. Area in blue indicates Keep Out Area
3. Contact TE if keep out zone cannot be guaranteed.

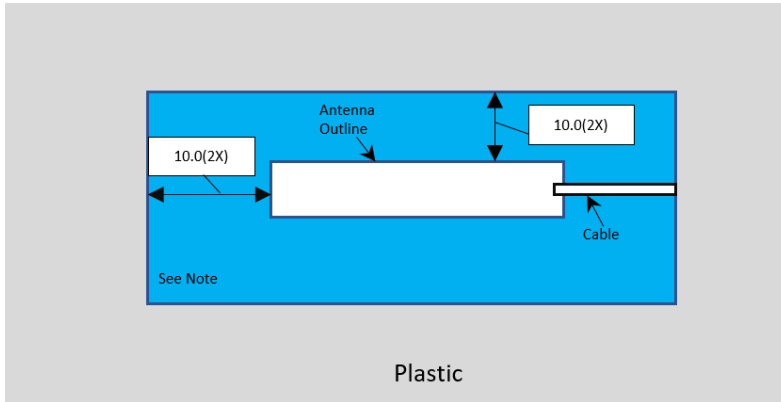

Dimension: mm
Diagrams is not into scale

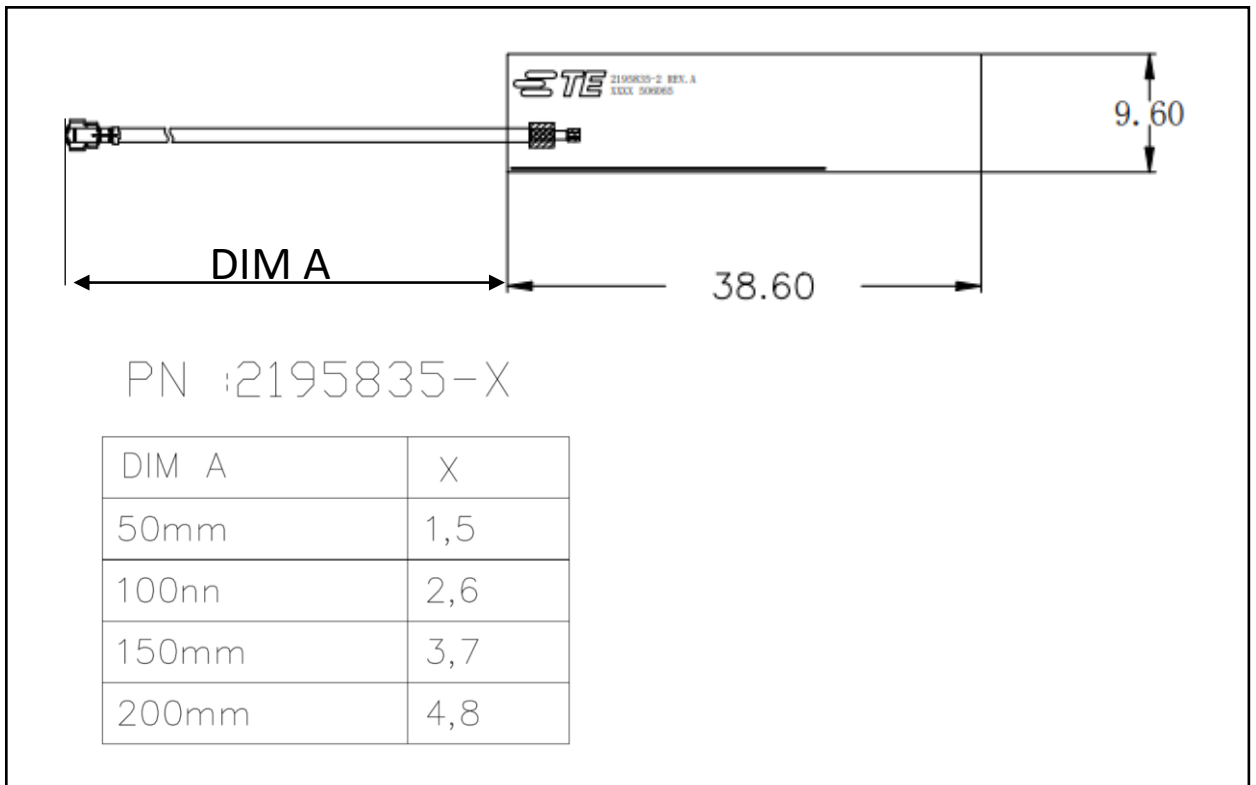

DIMENSIONS



ISM 868 / 915 MHz ANTENNA

Standard Antenna Solutions

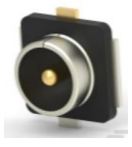
MATING COMPONENTS

2195835-1	50	1.97	MHF-TYPE PLUG	1.13	RECEPTACLE (TE PN: 2337019-1)	
2195835-2	100	3.94	MHF-TYPE PLUG	1.13	RECEPTACLE (TE PN: 2337019-1)	
2195835-3	150	5.91	MHF-TYPE PLUG	1.13	RECEPTACLE (TE PN: 2337019-1)	
2195835-4	200	7.87	MHF-TYPE PLUG	1.13	RECEPTACLE (TE PN: 2337019-1)	
2195835-5	50	1.97	MHF4-TYPE PLUG	1.13	RECEPTACLE (TE PN: 2334884-1)	
2195835-6	100	3.94	MHF4-TYPE PLUG	1.13	RECEPTACLE (TE PN: 2334884-1)	
2195835-7	150	5.91	MHF4-TYPE PLUG	1.13	RECEPTACLE (TE PN: 2334884-1)	
2195835-8	200	7.87	MHF4-TYPE PLUG	1.13	RECEPTACLE (TE PN: 2334884-1)	
PART NUMBER	MM	INCH	CONNECTOR TYPE (ON CABLE)	Cable Dia mm	PART NUMBER	IMAGE
	CABLE LENGTH ("A")				MATING COMPONENTS	

PACKAGING

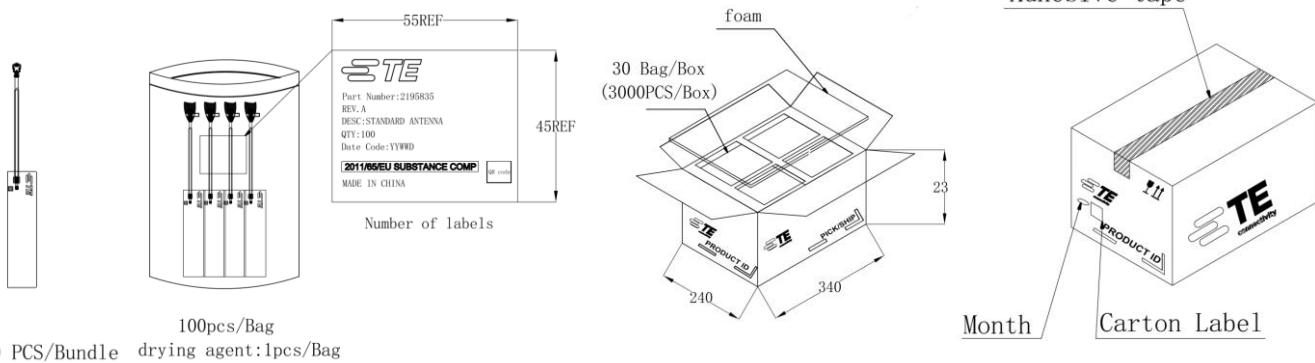

TE TECHNICAL SUPPORT CENTER

USA: +1 (800) 522-6752
 Canada: +1 (905) 475-6222
 Mexico: +52 (0) 55-1106-0800
 Latin/S. America: +54 (0) 11-4733-2200
 Germany: +49 (0) 6251-133-1999
 UK: +44 (0) 800-267666
 France: +33 (0) 1-3420-8686
 Netherlands: +31 (0) 73-6246-999
 China: +86 (0) 400-820-6015

For phone numbers in other countries, go to te.com/support-center

te.com

TE Connectivity, TE Connectivity (logo) are trademarks. All other logos, products and/or company names referred to herein might be trademarks of their respective owners.

The information given herein, including drawings, illustrations and schematics which are intended for illustration purposes only, is believed to be reliable. However, TE Connectivity makes no warranties as to its accuracy or completeness and disclaims any liability in connection with its use. TE Connectivity's obligations shall only be as set forth in TE Connectivity's Standard Terms and Conditions of Sale for this product and in no case will TE Connectivity be liable for any incidental, indirect or consequential damages arising out of the sale, resale, use or misuse of the product. Users of TE Connectivity products should make their own evaluation to determine the suitability of each such product for the specific application.

© 2020 TE Connectivity Ltd. family of companies All Rights Reserved.

09/2020