

# APPROVAL SHEET

**RFANT Series – RoHS Compliance**

MULTILAYER CERAMIC ANTENNA

**Halogens Free Product**

2.4 GHz ISM Band RF Application

**P/N: RFANT3216120A5T**

\*Contents in this sheet are subject to change without prior notice.

**FEATURES**

1. Surface Mounted Devices with a small dimension of 3.2 X 1.6 X1.2 mm<sup>3</sup> meet future miniaturization trend.
2. LTCC process
3. High stability in Temperature / Humidity Change

**APPLICATIONS**

1. 2.4GHz ISM band RF applications
2. Bluetooth, Wireless, HomeRF

**CONSTRUCTION**

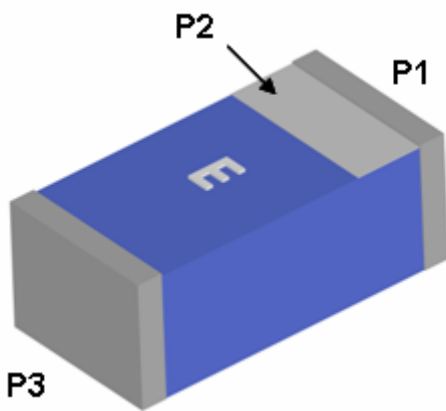

PIN	Connection
1	Feeding
2	Identification Mark
3	Soldering terminal

**DIMENSIONS**

Figure	Symbol	Dimension (mm)
	L	3.20 ± 0.20
	W	1.60 ± 0.10
	T	1.20 ± 0.10
	A	0.25 ± 0.15

**ELECTRICAL CHARACTERISTICS**

<b>RFANT3216120A5T</b>		<b>Specification</b>
Working Frequency Range		2450 ± 50 MHz
Fc (GHz)		2.9
Gain (dBi)		2 (Typical)
VSWR		2 max.
Matching component value	Series 1	6.8nH
	Series 2	-
Power Capacity		3 W max.
Maximum Input Power		5 Watts for 5 minutes
Operation Temperature		-40°C ~ +85°C
Polarization		Linear
Azimuth Beamwidth		Omni-directional

\* This frequency must be adjusted to 2.45GHz with matching circuit.

**SOLDER LAND PATTERN DESIGN**

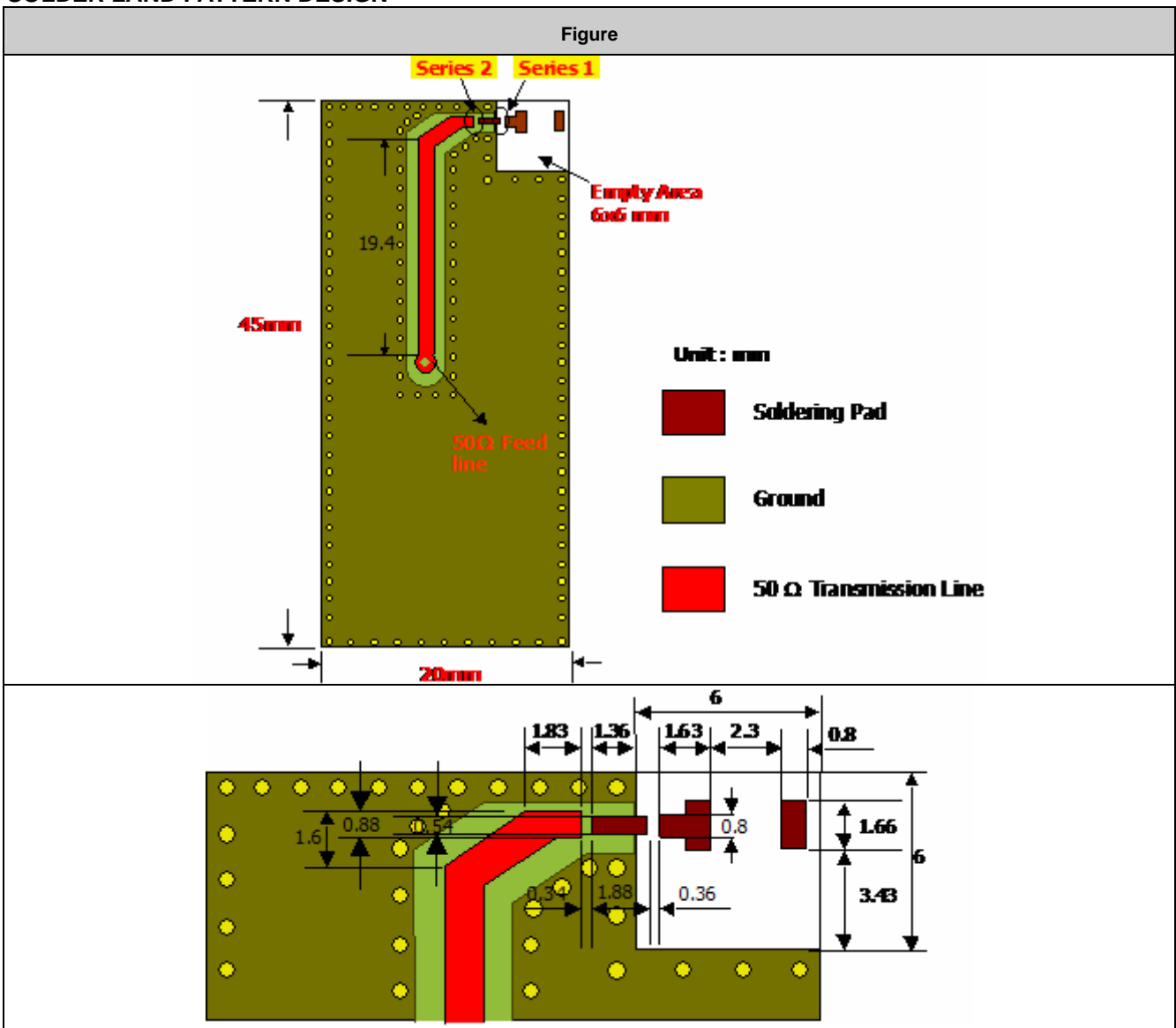

Antenna on Test Board ( Thickness 1.2mm)

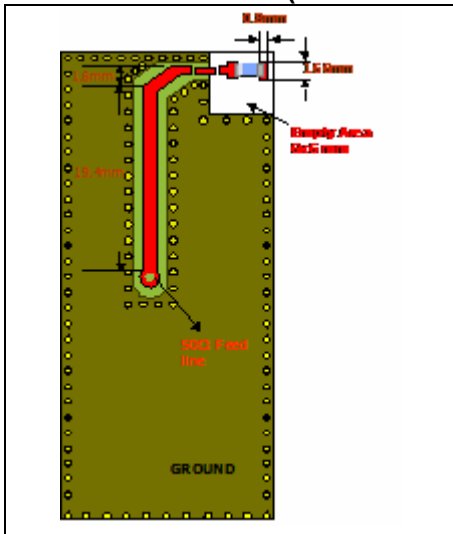

Antenna S11 on Test Board

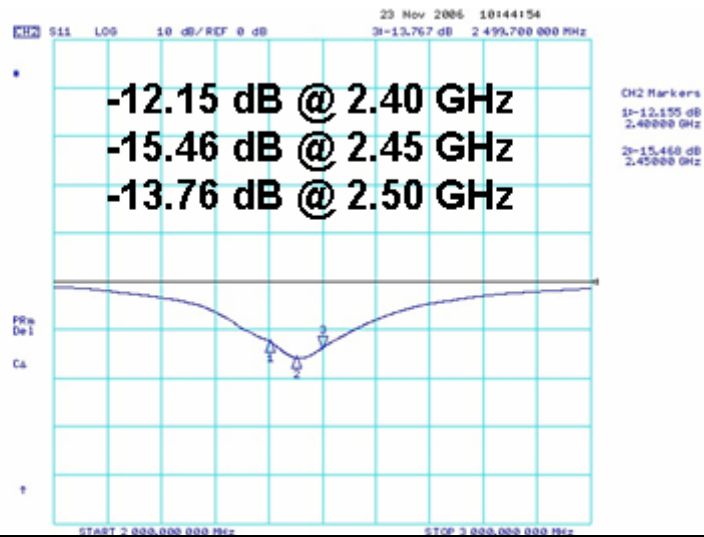

Antenna VSWR on Test Board

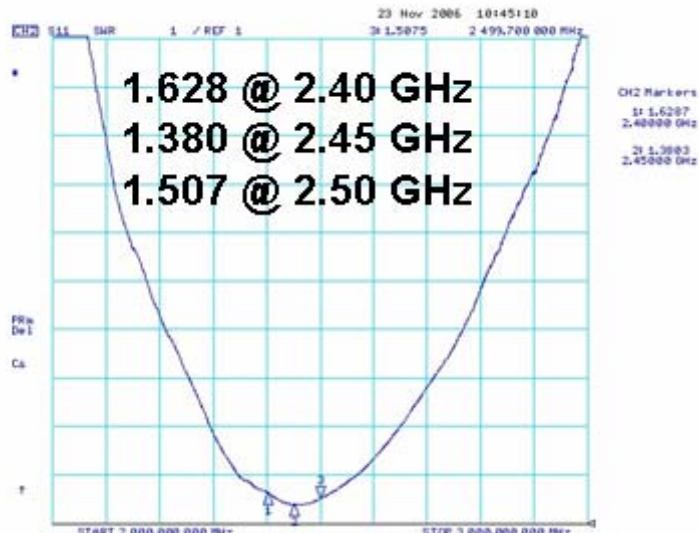

**RADIATION PATTERN**

Radiation Pattern and Gain were dependent on measurement board design. The specification of RFANT3216120A5T antenna was measured based on the PCB size and installation position as shown in the below figure Test Board

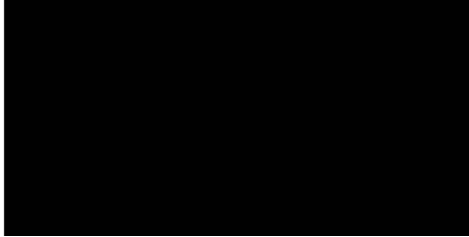

	Vertical	Horizontal
<b>Y - Z Plane</b>  Average Gain= 0.948 dBi	<p>Peak Gain = 2.93dBi Average Gain = 0.60dBi</p>	<p>Peak Gain= -5.60dBi Average Gain=-10.19dBi</p>
<b>X - Z Plane</b>  Average Gain= -2.147 dBi	<p>Peak Gain= -4.98 dBi Average Gain= -9.68dBi</p>	<p>Peak Gain= 1.61 dBi Average Gain= -2.99 dBi</p>
<b>X - Y Plane</b>  Average Gain= -2.810 dBi	<p>Peak Gain= -3.79 dBi Average Gain= -8.89dBi</p>	<p>Peak Gain= 0.77 dBi Average Gain= -4.04 dBi</p>

## RELIABILITY TEST

Test item	Test condition / Test method	Specification
Solderability JIS C 0050-4.6 JESD22-B102D	*Solder bath temperature : 235 ± 5°C *Immersion time : 2 ± 0.5 sec Solder : Sn3Ag0.5Cu for lead-free	At least 95% of a surface of each terminal electrode must be covered by fresh solder.
Leaching (Resistance to dissolution of metallization) IEC 60068-2-58	*Solder bath temperature : 260 ± 5°C *Leaching immersion time : 30 ± 0.5 sec Solder : SN63A	Loss of metallization on the edges of each electrode shall not exceed 25%.
Resistance to soldering heat JIS C 0050-5.4	*Preheating temperature : 120~150°C , 1 minute. *Solder temperature : 270±5°C *Immersion time : 10±1 sec Solder : Sn3Ag0.5Cu for lead-free Measurement to be made after keeping at room temperature for 24±2 hrs	No mechanical damage. Electrical specification shall satisfy the descriptions in electrical characteristics under the operational temperature range within -40 ~ 85°C. Loss of metallization on the edges of each electrode shall not exceed 25%.
Drop Test JIS C 0044 Customer's specification.	*Height : 75 cm *Test Surface : Rigid surface of concrete or steel. *Times : 6 surfaces for each units ; 2 times for each side.	No mechanical damage. Electrical specification shall satisfy the descriptions in electrical characteristics under the operational temperature range within -40 ~ 85°C.
Vibration JIS C 0040	*Frequency : 10Hz~55Hz~10Hz(1min) *Total amplitude : 1.5mm *Test times : 6hrs.(Two hrs each in three mutually perpendicular directions)	No mechanical damage. Electrical specification shall satisfy the descriptions in electrical characteristics under the operational temperature range within -40 ~ 85°C.
Adhesive Strength of Termination JIS C 0051- 7.4.3	*Pressurizing force : 5N(≤0603) ; 10N(>0603) *Test time : 10±1 sec	No remarkable damage or removal of the termination.
Bending test JIS C 0051- 7.4.1	The middle part of substrate shall be pressurized by means of the pressurizing rod at a rate of about 1 mm/s per second until the deflection becomes 1mm/s and then pressure shall be maintained for 5±1 sec. Measurement to be made after keeping at room temperature for 24±2 hours	No mechanical damage. Electrical specification shall satisfy the descriptions in electrical characteristics under the operational temperature range within -40 ~ 85°C.

Temperature cycle JIS C 0025	<ol style="list-style-type: none"> <li>1. 30±3 minutes at -40°C±3°C,</li> <li>2. 10~15 minutes at room temperature,</li> <li>3. 30±3 minutes at +85°C±3°C,</li> <li>4. 10~15 minutes at room temperature,</li> </ol> Total 100 continuous cycles  Measurement to be made after keeping at room temperature for 24±2 hrs	No mechanical damage.  Electrical specification shall satisfy the descriptions in electrical characteristics under the operational temperature range within -40 ~ 85°C.
High temperature JIS C 0021	*Temperature : 85°C±2°C *Test duration : 1000+24/-0 hours  Measurement to be made after keeping at room temperature for 24±2 hrs	No mechanical damage.  Electrical specification shall satisfy the descriptions in electrical characteristics under the operational temperature range within -40 ~ 85°C.
Humidity (steady conditions) JIS C 0022	*Humidity : 90% to 95% R.H. *Temperature : 40±2°C *Time : 1000+24/-0 hrs.  Measurement to be made after keeping at room temperature for 24±2 hrs  ※ 500hrs measuring the first data then 1000hrs data	No mechanical damage.  Electrical specification shall satisfy the descriptions in electrical characteristics under the operational temperature range within -40 ~ 85°C.
Low temperature JIS C 0020	*Temperature : -40°C±2°C *Test duration : 1000+24/-0 hours  Measurement to be made after keeping at room temperature for 24±2 hrs	No mechanical damage.  Electrical specification shall satisfy the descriptions in electrical characteristics under the operational temperature range within -40 ~ 85°C.

**SOLDERING CONDITION**

Typical examples of soldering processes that provide reliable joints without any damage are given in Fig 2

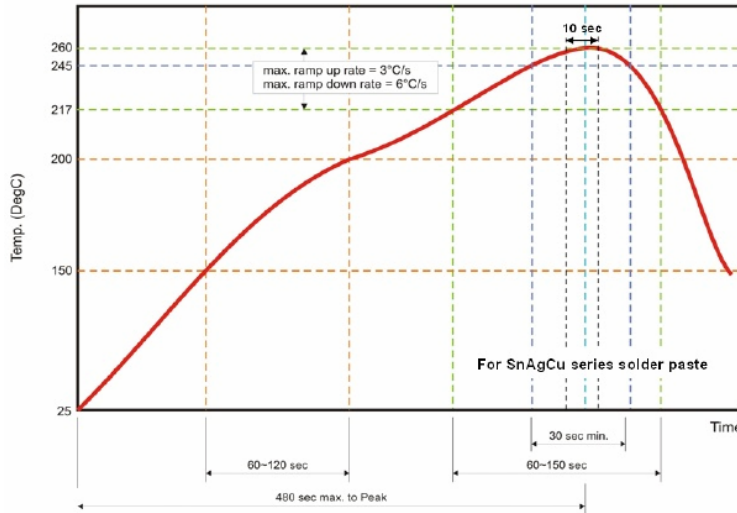

Fig 2. Infrared soldering profile

**ORDERING CODE**

RF	ANT	321612	0	A	5	T
<b>Walsin</b> RF device	<b>Product code</b> ANT : Antenna	<b>Dimension code</b> Per 2 digits of Length, Width, Thickness : e.g. : 321612 = Length 32, Width 16, Thickness 12	<b>Unit of dimension</b> 0 : 0.1 mm 1 : 1.0 mm	<b>Application</b> A : 2.4GHz ISM Band	<b>Specification</b> Design Code	<b>Packing</b> T : 7" Reeled

Minimum Ordering Quantity: 2000 pcs per reel.

**PACKAGING**

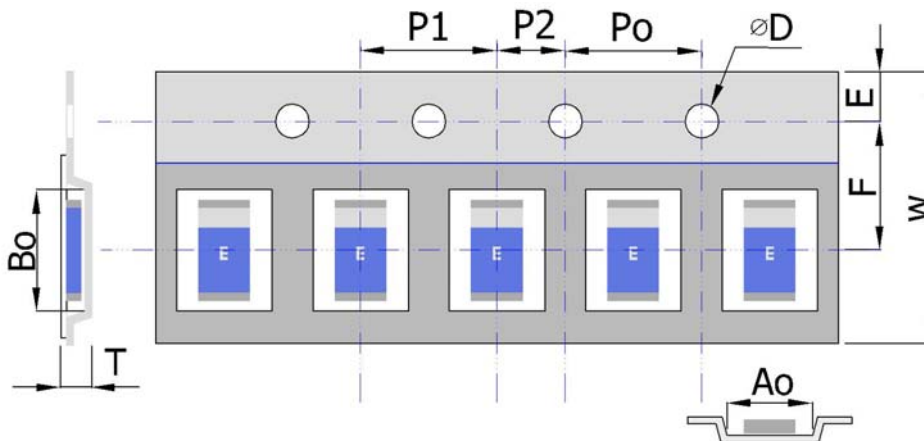

Plastic Tape specifications (unit :mm)

Index	Ao	B0	ΦD	T	W
Dimension (mm)	1.81± 0.10	3.42 ± 0.10	1.55 ± 0.05	1.26 ± 0.10	8.20 +0.10 -0.30
Index	E	F	Po	P1	P2
Dimension (mm)	1.75 ± 0.10	3.50 ± 0.05	4.00 ± 0.10	4.00 ± 0.10	2.00 ± 0.10



## Reel dimensions

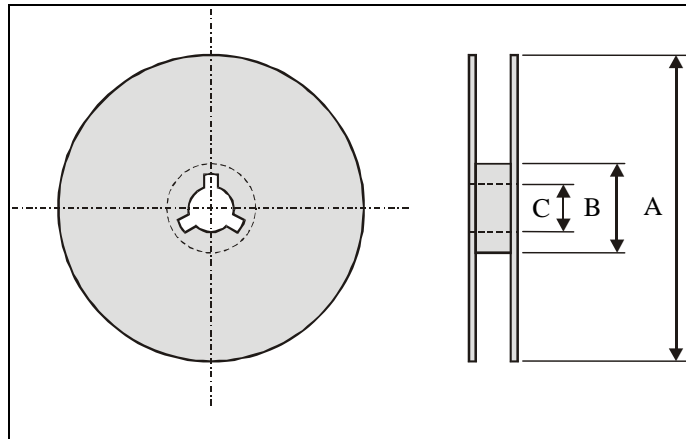

Index	A	B	C
Dimension (mm)	Φ178	Φ60.0	Φ13.5

Typing Quantity: 2000 pieces per 7" reel

## CAUTION OF HANDLING

### Limitation of Applications

Please contact us before using our products for the applications listed below which require especially high reliability for the prevention of defects, which might directly cause damage to the third party's life, body or property.

- (1) Aircraft equipment
- (2) Aerospace equipment
- (3) Undersea equipment
- (4) Medical equipment
- (5) Disaster prevention / crime prevention equipment
- (6) Traffic signal equipment
- (7) Transportation equipment (vehicles, trains, ships, etc.)
- (8) Applications of similar complexity and /or reliability requirements to the applications listed in the above.

### Storage condition

- (1) Products should be used in 6 months from the day of WAL SIN outgoing inspection.
- (2) Storage environment condition.
  - Products should be storage in the warehouse on the following conditions.
  - Temperature : +5 to +40℃
  - Humidity : 30 to 70% relative humidity
  - Don't keep products in corrosive gases such as sulfur. Chlorine gas or acid or it may cause oxidization of electrode, resulting in poor solderability.
  - Products should be storage on the palette for the prevention of the influence from humidity, dust and son on.
  - Products should be storage in the warehouse without heat shock, vibration, direct sunlight and so on.
  - Products should be storage under the airtight packaged condition.