

RF Exposure Evaluation Report

For

Shenzhen Kuaimen photographic Equipment Co.,Ltd

Product Name: LED Fill Light

Test Model(s): CL-V17

Report Reference No. : DACE240730007RL002

FCC ID : 2BH9ACL-V17

Applicant's Name : Shenzhen Kuaimen photographic Equipment Co.,Ltd

Address : 7F,Building E,DonghaiWang Mansion,Bulong Road,Bantian Street,
Longgang District,Shenzhen

Testing Laboratory : Shenzhen DACE Testing Technology Co., Ltd.

Address : 102 Building H1 & 1/F., Building H, Hongfa Science & Technology Park,
Tangtou, Shiyan, Bao'an District, Shenzhen, Guangdong, China

Date of Receipt : July 30, 2024

Date of Test : July 30, 2024 to August 9, 2024

Data of Issue : August 9, 2024

Result : **Pass**

Note: This report shall not be reproduced except in full, without the written approval of Shenzhen DACE Testing Technology Co., Ltd. This document may be altered or revised by Shenzhen DACE Testing Technology Co., Ltd. personnel only, and shall be noted in the revision section of the document. The test results in the report only apply to the tested sample.

1 GENERAL INFORMATION

1.1 Client Information

Applicant's Name : Shenzhen Kuaimen photographic Equipment Co.,Ltd
Address : 7F,Building E,DonghaiWang Mansion,Bulong Road,Bantian Street,Longgang District,Shenzhen

Manufacturer : Dongguan Kuaiyin Electronic Technology Co., Ltd.
Address : Room 301, No. 16, Fengping Road, Sanzhong, Qingxi Town, Dongguan City, Guangdong

1.2 Description of Device (EUT)

Product Name:	LED Fill Light
Model/Type reference:	CL-V17
Series Model:	N/A
Trade Mark:	N/A
Power Supply:	DC 5V/3A from adapter
Operation Frequency:	115KHz~205KHz
Number of Channels:	N/A
Modulation Type:	MSK
Antenna Type:	Inductive loop coil Antenna
Antenna Gain:	0dBi (Max)
Hardware Version:	V1.0
Software Version:	V1.0

1.3 Description of Support Units

Title	Manufacturer	Model No.	Serial No.
AC-DC adapter	HUAWEI TECHNOLOGY	HW100400C01	/
Wireless Charging Load Module	N/A	N/A	Wireless Input Power:10W

1.4 Equipments Used During The Test

Test Equipment	Manufacturer	Model No.	SN.	Cal.Date (mm-dd-yy)	Cal.Due date (mm-dd-yy)
Exposure Level Tester	Narda	ELT-400	N-0231	2023-12-14	2024-12-13
Magnetic field probe 100cm ²	Narda	ELT probe 100cm ²	M0675	2023-12-14	2024-12-13

Common parameter	
Operating temperature	-10 °C ~ +50 °C
Operation humidity	< 95 % (30 °C) or < 29 g/m ³
Weight	910 g
Size	180 mm x 100 mm x 55 mm(Main engine) / 290 mm x 125 mm Ø (Probe)
Display	LCD backlit display, 4 refresh rates per second
Battery	Nimh battery (4 x Mignon, AA), rechargeable
Operating time, typical	12 h
Power supply	100 ~240 V AC / 47 ~ 63 Hz
Charging time, typical	2 hours
Recommended calibration cycle	24 months
Country of origin	Germany

1.5 Statement Of The Measurement Uncertainty

Test Item	Measurement Uncertainty
ELT-400	0.8dB
Note: (1) This uncertainty represents an expanded uncertainty expressed at approximately the 95% confidence level using a coverage factor of k=2.	

2 Evaluation Method

2.1 Refer Evaluation Method

ANSI C95.1–1999: IEEE Standard for Safety Levels with Respect to Human Exposure to Radio Frequency Electromagnetic Fields, 3 kHz to 300 GHz.

FCC KDB publication 680106 D01 v04 RF Exposure Wireless Charging Apps v03: RF Exposure Considerations for Low Power Consumer Wireless Power Transfer Applications

FCC CFR 47 part1 1.1310: Radiofrequency radiation exposure limits.

FCC CFR 47 part2 2.1091: Radiofrequency radiation exposure evaluation: mobile devices

FCC CFR 47 part2 2.1093: Radiofrequency radiation exposure evaluation: portable devices

FCC CFR 47 part 18.107: Industrial, Scientific, and Medical Equipment

2.2 Evaluation Requirements

Per KDB 680106 D01 v04 Section 3. RF Exposure Requirements;

- 1) Consumer wireless power transfer devices approved under Part 18 in some cases have to demonstrate compliance with RF exposure requirements. The potential for exposure must be assessed according to the operating configurations of the wireless system and the exposure conditions of users and bystanders. RF exposure must be evaluated with the client device(s) being charged by the primary at maximum output power. The RF exposure requirements must be determined in conjunction with the device operating characteristics, according to the mobile and portable exposure requirements in Section 2.1091 and Section 2.1093 of the rules. SAR and MPE limits do not cover the frequency range for wireless power transfer applications which operate below 100 kHz and 300 kHz respectively; therefore, RF exposure compliance needs to be determined with respect to 1.1307 (c) and (d) of the FCC rules.
- 2) Based on the design and implementation of the power transfer application, it must be clearly identified if mobile or portable RF exposure conditions apply. Devices that are installed to provide separation of at least 20 cm from users and bystanders may qualify for mobile exposure conditions. For some conditions where users and bystanders may be exposed at closer than 20 cm, section 2.1091(d) (4) of the rules may apply.
- 3) For devices designed for typical desktop applications, such a wireless charging pads, RF exposure evaluation should be conducted assuming a user separation distance of 15 cm. E and H field strength measurements or numerical modeling may be used to demonstrate compliance. Measurements should be made from all sides and the top of the primary/client pair, with the 15 cm measured from the center of the probe(s) to the edge of the device. Emissions between 100 kHz to 300 kHz should be assessed versus the limits at 300 kHz in Table 1 of Section 1.1310: 614 V/m and 1.63 A/m. A KDB inquiry is required to determine the applicable exposure limits below 100 kHz.
- 4) Portable exposure conditions from 100 kHz to 6 GHz are determined with respect to SAR requirements. Existing SAR systems and test procedures are generally intended for measurements above 100 MHz. While numerical modeling can be an alternative, the constraints of substantial computational resources at low frequencies could introduce further limitations. Under these circumstances, including operations below 100 kHz, the Commission may consider a combination of analytical analysis, field strength, radiated and conducted power measurements, in conjunction with some limited numerical modeling to assess compliance.
- 5) Depending on the operating frequency, existing SAR and MPE measurement procedures may be adapted to evaluate wireless power transfer devices for compliance with respect to mobile or portable exposure conditions. If the grantee or its test lab have any questions regarding RF exposure evaluation they should contact the FCC Laboratory with sufficient system operating configuration details to determine if RF exposure evaluation is necessary and, if required, how to apply specific test procedures. Below 100 MHz, when SAR testing is required and the device is operating at close proximity to persons, information on device design, implementation, operating configurations, exposure conditions of users and bystanders are needed to determine the evaluation and testing requirements. In addition, the influence of nearby objects may also need consideration according to the wireless power transfer system implementation; for example, the effects of placing the device, its coils or radiating elements on or near metallic surfaces

2.3 Limits

Limits for Maximum Permissible Exposure (MPE)/Controlled Exposure

Frequency Range(MHz)	Electric Field Strength(V/m)	Magnetic Field Strength(A/m)	Power Density (mW/cm ²)	Averaging Time (minute)
Limits for Occupational/Controlled Exposure				
0.3-3.0	614	1.63	*100	6
3.0-30	1842/f	4.89/f	*900/f ²	6
30-300	61.4	0.163	1.0	6
300-1,500	/	/	f/300	6
1,500-100,000	/	/	5	6

Limits for Maximum Permissible Exposure (MPE)/Uncontrolled Exposure

Frequency Range(MHz)	Electric Field Strength(V/m)	Magnetic Field Strength(A/m)	Power Density (mW/cm ²)	Averaging Time (minute)
Limits for General Population/Uncontrolled Exposure				
0.3-1.34	614	1.63	*100	30
1.34-30	824/f	2.19/f	*180/f ²	30
30-300	27.5	0.073	0.2	30
300-1,500	/	/	f/1500	30
1,500-100,000	/	/	1.0	30

F=frequency in MHz

*=Plane-wave equivalent power density

According to FCC KDB 680106 D01 v04Section 3. RF Exposure Requirements clause 3 the Emission-Limits in the frequency range from 100 KHz to 300 KHz should be assessed versus the limits at 300 KHz in Table 1 of CFR 47 – Section1.310 as following (measured distance shall be 15cm from the center of the probe to the edge of the device):

Frequency	E-Field(V/m)	A/m	uT
0.3 MHz – 3.0 MHz	614	1.613	2.0
3.0 MHz – 30 MHz	824/f	2.19/f	--

A KDB inquire was required to determine/confirm the applicable limits below 100 KHz.

2.4 Test Setup Diagram

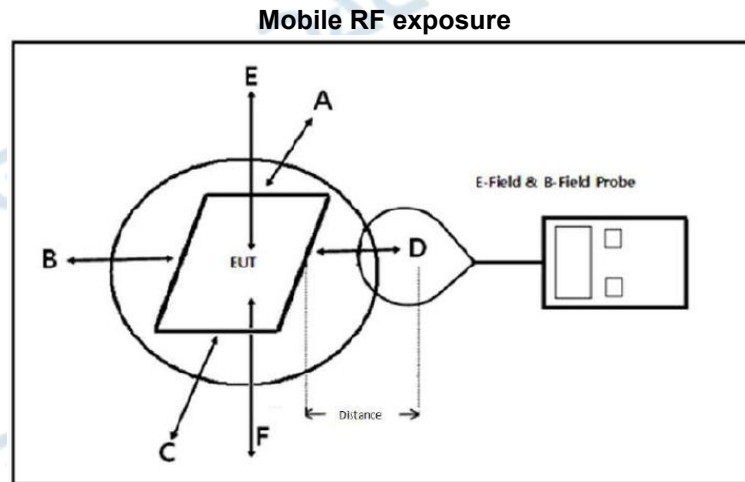

Note: The distance of the points A/B/C/D is 15cm, and the point E is 20cm.

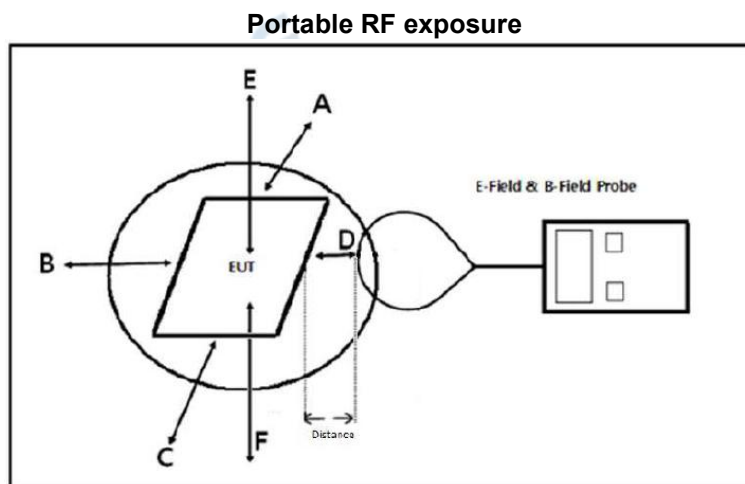

Note: The distance of the points A/B/C/D/E/F is 0,2,4,6,8,10,12,14,16,18, 20cm.

The values tested by the probe are X, Y, and Z on three axes perpendicular to the edge of the device. Top and bottom side coincident with the axis(Y) of the main coil.

2.5 Measurement Procedure

For mobile exposure conditions:

- a. The RF exposure test was performed in anechoic chamber.
- b. E and H-field measurements should be made with the center of the probe at a distance of 15 cm surrounding the EUT and 20 cm above the top surface of the primary/client pair.
- c. The highest emission level was recorded and compared with limit.
- d. The EUT was measured according to the KDB 680106 D01 v04 Wireless Power Transfer v04.

For portable exposure conditions:

- a. The RF exposure test was performed in anechoic chamber.
- b. Perform H-field measurements for each edge/top surface of the host/client pair at every 2 cm, starting from as close as possible out to 20 cm

- c. The highest emission level was recorded and compared with limit.
- d. The EUT was measured according to the KDB 680106 D01 v04 Wireless Power Transfer v04.

2.6 Equipment Approval Considerations

The EUT does comply with item 5.2 of KDB 680106 D01 v04 as follows table;

1.WPT operating frequency (or frequencies).	The device operate in the frequency range 115KHz~205KHz
2.Output power for each radiating structure.	Maximum 10W
Number of radiating structure(Coil)	Only one radiated Coil
3.A client device providing the maximum permitted load is placed in physical contact with the transmitter (i.e., the surfaces of the transmitter and client device enclosures need to be in physical contact).	Yes, the surfaces of the transmitter and client device enclosures are in physical contact
4.Only §2.1091-Mobile exposure conditions apply (i.e., this provision does not cover §2.1093-Portable exposure conditions).	No, the EUT is portable condition assessment.
5.The E-field and H-field strengths, at and beyond 20 cm surrounding the device surface, are demonstrated to be less than 50% of the applicable MPE limit, per KDB 447498,Table 1.	Yes, the EUT field strength levels are less 50% * MPE limit.
6.For systems with more than one radiating structure, the conditions specified in (5) must be met when the system is fully loaded (i.e., clients absorbing maximum power available), and with all the radiating structures operating at maximum power at the same time, as per design conditions.	Yes, the EUT has only one coil, all test modes met the conditions specified in (5).

In all other cases, unless excluded above, an RF exposure evaluation report must be reviewed and accepted through a KDB or PBA inquiry to enable authorization of the equipment. When evaluation is required to show compliance; for example, using field strength, power density, SAR measurements or computational modeling etc., the specific authorization requirements will be determined based on the results of the RF exposure evaluation.

2.7 Test mode

No	Description	
TM1	Keep the EUT in wireless charging mode(EUT + Wireless Input Power:5W)	Wireless Input Power:5W
TM2	Keep the EUT in wireless charging mode(EUT + Wireless Input Power:7.5W)	Wireless Input Power:7.5W
TM3	Keep the EUT in wireless charging mode(EUT + Wireless Input Power:10W)	Wireless Input Power:10W
Remark:TM1 is the full load mode, the full load mode is the worst mode,Only the data of the worst mode would be recorded in this report.		

NOTE: 1. $A/m = uT/1.25 = (mT/1000)/1.25$, $V/m = 10^{((20 \lg(A/m * 10^6) + 51.5) - 120)/20}$

2. H-Field Strength at 15 cm from the edges surrounding and 20cm from the top surface of the EUT

2.8 Test Result:

For portable exposure condition:

- (1). The portable test modes have covered the considerations of the mobile test, only record the test data of the portable conditions in this report.
- (2) Operating modes with client device (1 %, 50%, 99% battery status of client device) have been test, only show the data of worst case of 1% battery status of client device.
- (3) Test performed with all the radiating structures operating at maximum power at the same time.
- (4) H-field measurements are taken along all three axes the device from 0cm~20cm in 2cm minimum increment for each edge surface of the host/client pair. If the center of the probe sensing element is more than 5mm from the probe outer edge, the field strengths need to be estimated for the positions that are not reachable.
- (5) According to Calibration information and specification about ETL-400 Probe, The Probe ETL-400 Probe's sensitive elements center is located in the probe's center, and the distance from the sensitive elements center to the tip of probe is 6.25cm.
- (6) The actual 0cm, 2cm, 4cm and 6cm field strengths need to be estimated for the positions that are not reachable via numerical calculation.
- (7) Use Biot-Savart formula theory to estimate the strength of the magnetic field that the measuring instrument cannot measure. According to Biot-Savart formula:

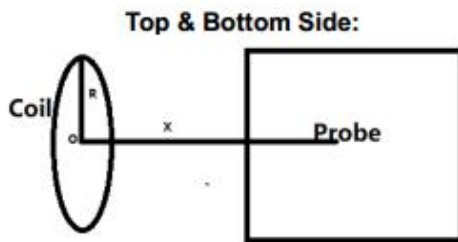

$$B = \frac{\mu_0 * I * N * R^2}{2 * (R^2 + x^2)^{3/2}}$$

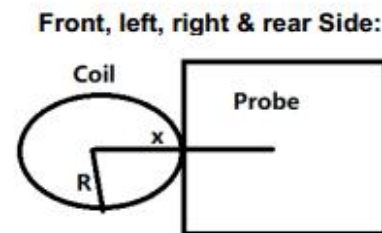

$$B = \frac{\mu_0 * I * N}{2 * x}$$



x(Unit:m): means the center of the coil to the sensing elements of the probe. (For top & bottom side: x=test distance; For other side: x=test distance+R)

Top:0mm
Bottom:15mm(0.015m)
Left:30mm(0.030m)
Right:33mm(0.033m)
Front :76mm(0.076m)
Back:33mm(0.033m)

B(Unit:A/m): means H-field value;

μ_0 is space permeability; $\mu_0=4\pi*10^{-7}$;

I(Unit:A): A current element passing through a radiated coil;

R(Unit:m): means the Radius of radiated coil,According to provided Antenna specification:

$R=38.5/2=19.25\text{mm}=0.01925\text{m}$;

Test Distance(Unit:m): The distance from the sensing element of the probe to the edge of the device surface.

x(Unit:m): means the center of the coil to the sensing elements of the probe. (For top & bottom side: x=test distance; For other side: x=test distance+R)

N: Number of turns, according to providing “Antenna specification” files: N=11.

(8) For validation purposes: If the value to show a 30% agreement between the mode and the probe measurements for the two closest points to the device surface, and with 2cm increments. Then this extrapolation method is reasonable.

(9) Coil Size

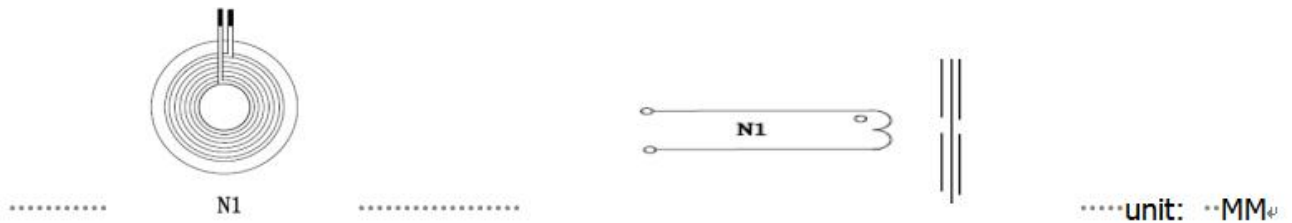

OUTSIDE DIAGRA

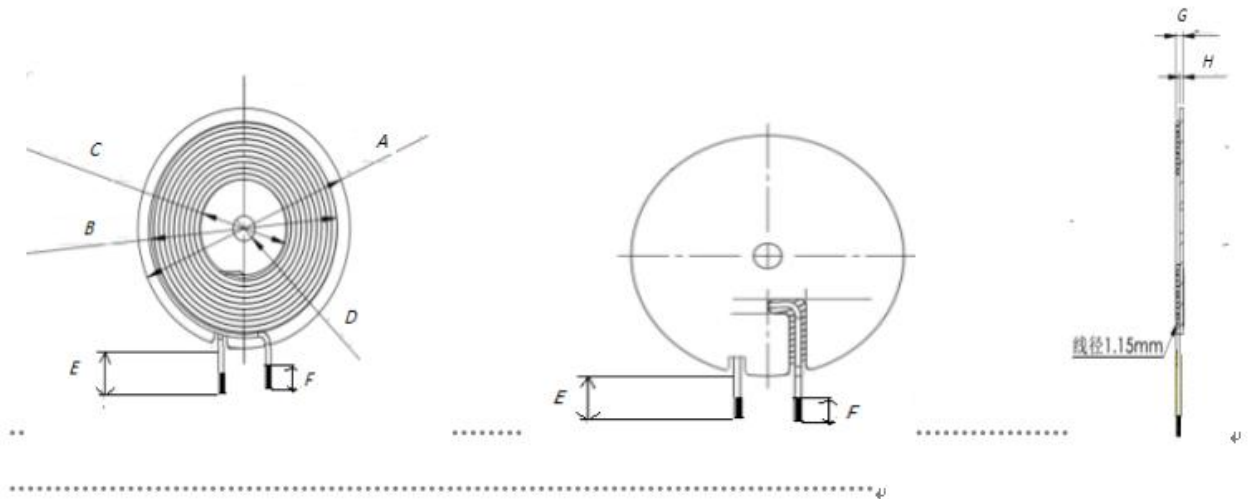

stan dard	A	B	C	D	E	F	G
STD	41.5±0.5	38.5±0.5	20.5±0.5	5.3±0.5	20±2	3±1	1.6±0.5

Item	Parameter
Input inductance:	Transmitter 1: 6.3 μH±5%
Material of enclosure(s):	Multiple strands of enamelled wire
Number of turns:	Transmitter 1: 11 turns

2.8.1 Validation results for the numerical calculation model

- a) Measure with probe directed contact(test distace:6.25cm)
 - b) Using Biot-Savart formula to calculate estimated results at test distace of 8cm and 10 cm;
 - c) measure at test distace of 8 cm and 10cm;
 - d) Compares the estimated results and measured result, the varation should not be greater than 30%;
- Conclusion: The numerical calculation model is valid.

Distance (cm)	Type	Result						Limit
		Top	Bottom	Left	Right	Front	Back	
6.25	Measured	0.0170	0.0127	0.2183	0.2767	0.1443	0.2498	1.63(A/m)
8	Measured	0.01421	0.01427	0.0136	0.01405	0.01418	0.01301	1.63(A/m)
8	Estimate	0.01411	0.01456	0.01365	0.01422	0.01467	0.01416	1.63(A/m)
	Var.	-1%	2%	0%	1%	3%	8%	±30%
10	Measured	0.0141	0.01383	0.01459	0.01405	0.01452	0.01446	1.63(A/m)
10	Estimate	0.01437	0.01418	0.01376	0.01454	0.01464	0.01422	1.63(A/m)
	Var.	2%	2%	-6%	3%	1%	-2%	±30%

Mea.-Measured H-field(A/m); Est.-Estimated H-field(A/m);
 Var.-Varation between measured and estimated value(%);

2.8.2 Final H-Field Emission level with a combination of measured and estimated results.

Test condition: Mode 1

Distance (cm)	Type	Result(A/m)						Limit(A/m)
		Top	Bottom	Left	Right	Front	Back	
0	Estimate	0.01386	0.01392	0.01453	0.0145	0.01457	0.01397	1.63
2	Estimate	0.01396	0.01399	0.01427	0.01365	0.01458	0.01436	1.63
4	Estimate	0.01443	0.01443	0.0143	0.0137	0.01407	0.01435	1.63
6	Estimate	0.0144	0.01369	0.01293	0.01353	0.01414	0.01425	1.63
8	Measured	0.01421	0.01427	0.0136	0.01405	0.01418	0.01301	1.63
10	Measured	0.0141	0.01383	0.01459	0.01405	0.01452	0.01446	1.63
12	Measured	0.01388	0.01399	0.01441	0.01397	0.01371	0.01452	1.63
14	Measured	0.0142	0.01422	0.01426	0.01453	0.01417	0.01465	1.63
16	Measured	0.01441	0.01479	0.01358	0.01371	0.01355	0.01375	1.63
18	Measured	0.01329	0.01293	0.01278	0.01272	0.0143	0.013	1.63
20	Measured	0.0011	0.0009	0.0957	0.089	0.0802	0.0922	1.63

2.9 Conclusion

A minimum safety distance of 0 cm to the antenna is required when the device is charging a smart phone for portable exposure. The detected emissions are below the limitations according FCC KDB 680106 and confirmed by the FCC according to KDB Inquire.

3 TEST SETUP PHOTOS

(The separation distance from the geometric center of the probe to the edge of the device is 6.25cm)

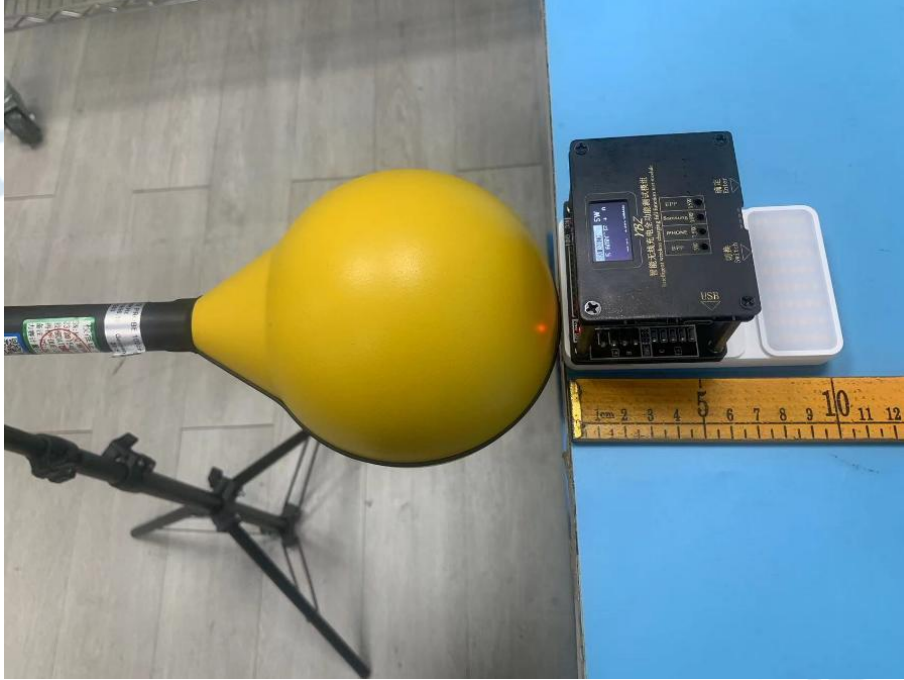

0cm-Left

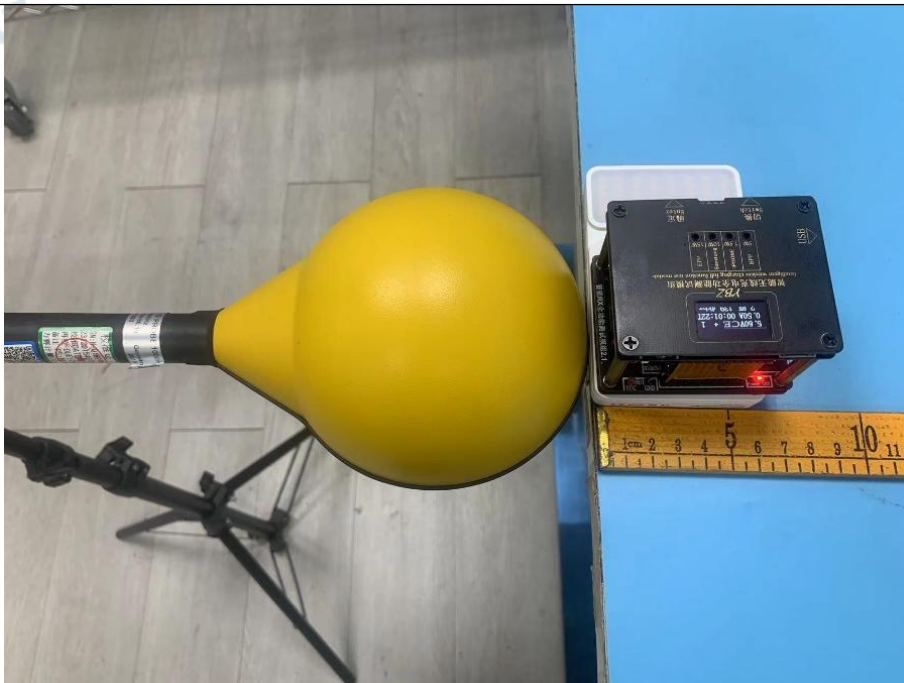

0cm-Right



0cm-Front



0cm -Back

***** End of Report *****