

Dual-Lens Floodlight Camera

Installation Instruction

MODEL: 3-LBC60M

SAFETY INFORMATION



- WARNING: Risk of electrical shock**
- Disconnect power at the fuse or circuit breaker before installing.
 - Verify that the supply voltage is correct. Connect fixture to a 100-240V ~ 50/60Hz power source.

Properly ground fixture.

Always follow code standards when installing wire connections. If you are outside of North America, installation and wiring must be performed by a licensed electrician.

CAUTION: Risk of fire
Do not install near combustible or flammable surfaces.

NOTICE

Do not connect this light fixture to a dimmer switch or timer. Floodlight Camera must be installed on a wall and on a UL listed junction box.

WARNING:

THIS PRODUCT MUST BE INSTALLED IN ACCORDANCE WITH THE APPLICABLE INSTALLATION CODE BY A PERSON FAMILIAR WITH THE CONSTRUCTION AND OPERATION OF THE PRODUCT AND THE HAZARDS INVOLVED.

DO NOT CONNECT THIS LIGHT FIXTURE TO AN UNGROUNDED ELECTRICAL SYSTEM. ATTACH GROUND FIXTURE WIRE TO EITHER GREEN GROUND SCREW ON MOUNTING PLATE OR THE GROUND WIRE IN THE OUTLET BOX.

COMPONENTS AND STRUCTURE

3-LBC60M

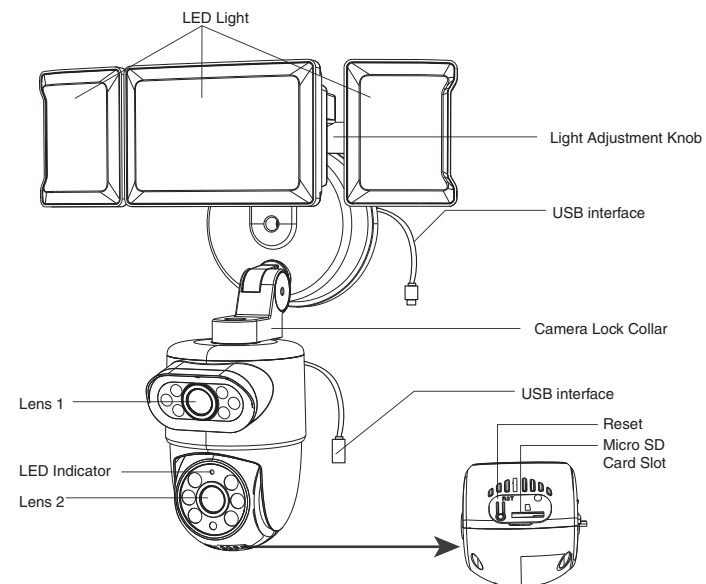
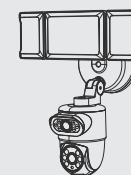

PARTS LIST

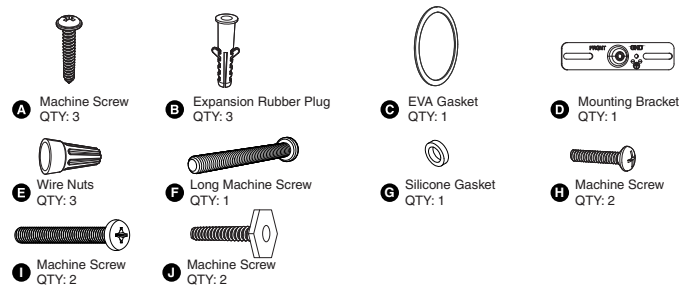

SPECIFICATIONS

| LED Floodlight | |
|--------------------|----------------------------|
| Model | 3-LBC60M |
| Input Voltage | 100-240V ~ 50/60Hz |
| Input Current | 0.6A |
| Rated Power | 55W |
| Luminous Flux | 5500lm |
| CCT | 6500K |
| CRI | ≥80 |
| Power Factor | ≥0.9 |
| L70B50 lifetime | 30000hours L70B50 @ 25° |
| Beam Angle | 120° |
| t _a | -20-40°C/-4°F-104°F |
| Luminaire Location | SUITABLE FOR WET LOCATIONS |

SPECIFICATIONS

| Camera | |
|-----------------------|---|
| Video | 4MP 2160*1920P |
| Field of View | 110° wide & 95° Height viewing angle |
| Tracking | Auto Tracking & Human Detection |
| Camera Angle | Pan & Tilt: 340° horizontal and 110° vertical rotation range |
| Audio | Two-Way Talk with Audio and advanced noise cancellation. |
| Internet Requirements | Recommended minimum upload speed of 2 Mbps per device. |
| Connectivity | 802.11 b/g/n/ac Wi-Fi connection @ 2.4Hz 902-928 Mhz Radio |
| Storage | Micro SD Card up to 128GB (not included) |

DIMENSIONS

| DIMENSIONS | |
|--------------------|---|
| Model | 3-LBC60M |
| Dimensions (LxHxW) | 274 x 313 x 174mm/ 10.79 x 12.32 x 6.85 in |
| Weight | 1.18kg/2.60 lb |

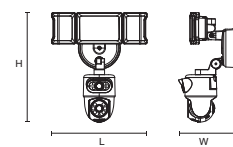

SHUT POWER OFF AT THE BREAKER

Turn off power to work area at main circuit breaker of fuse box
Caution: Please make sure your wall switch and power at main circuit breaker both off.

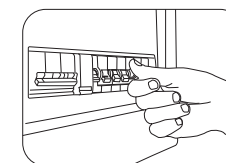

If you don't know where your breaker is or how to turn off power to your floodlight circuit, consult with a licensed electrician.

PREPARATION

NOTE:

Before beginning assembly of product, make sure all parts are present. Compare parts with parts list. If any part is missing or damaged, do not attempt to assemble the product. Estimated Assembly Time: 30-60 minutes.

Recommended to be installed 2.5m (8.2ft) above the ground but not higher than 5m (16.4ft).

Product appearance may vary from image shown.

TOOLS REQUIRED (not included)

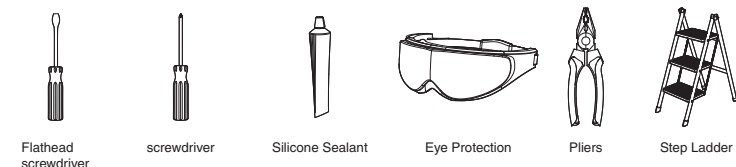

PROPER INSTALLATION HEIGHT

The proper installation height to optimize the motion sensor performance is around 2.5m (8.2ft)

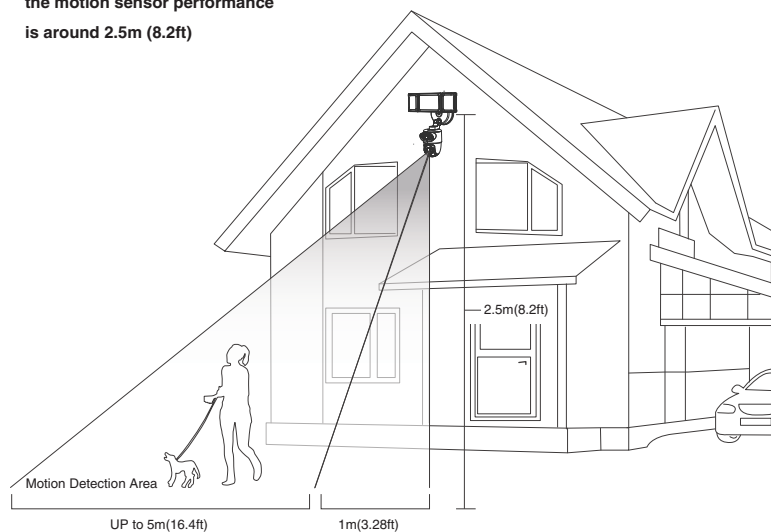

7



INSTALLATION STEPS

FOR WET LOCATION, MAKE SURE FILL FULL THE GAP OF EVA GASKET AND MOUNTING SURFACE WITH SEALING COMPOUND OR SILICONE GLUE.

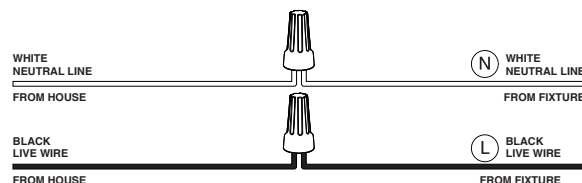
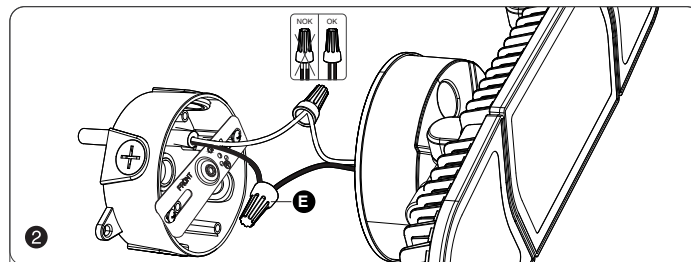
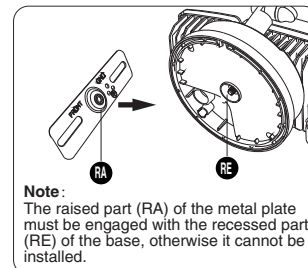
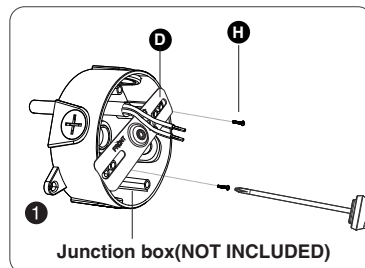

8

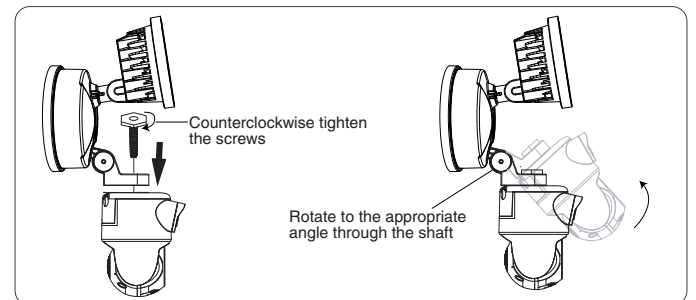
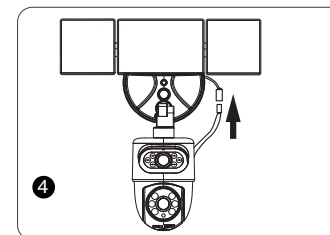
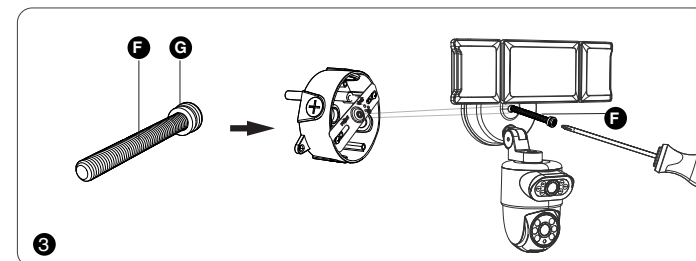

9



RESTORE POWER AT THE BREAKER

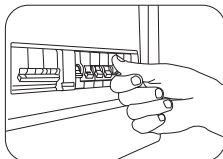

After restoring power, the lights will turn on and your Floodlight Camera will begin speaking to you to let you know it's in setup mode.

10



FCC ID: 2BH66-3-LBC60M

FCC Warning:

Any Changes or modifications not expressly approved by the party responsible for compliance could void the user's authority to operate the equipment.

This device complies with part 15 of the FCC Rules. Operation is subject to the following two conditions:

- (1) This device may not cause harmful interference, and
- (2) this device must accept any interference received, including interference that may cause undesired operation.

Note: This equipment has been tested and found to comply with the limits for a Class B digital device, pursuant to part 15 of the FCC Rules. These limits are designed to provide reasonable protection against harmful interference in a residential installation. This equipment generates uses and can radiate radio frequency energy and, if not installed and used in accordance with the instructions, may cause harmful interference to radio communications. However, there is no guarantee that interference will not occur in a particular installation. If this equipment does cause harmful interference to radio or television reception, which can be determined by turning the equipment off and on, the user is encouraged to try to correct the interference by one or more of the following measures:

- Reorient or relocate the receiving antenna.
- Increase the separation between the equipment and receiver.
- Connect the equipment into an outlet on a circuit different from that to which the receiver is connected.
- Consult the dealer or an experienced radio/TV technician for help.

This equipment complies with FCC radiation exposure limits set forth for an uncontrolled environment. This equipment should be installed and operated with minimum distance 20cm between the radiator & your body.

11



FAQ

Find answers to your FAQs and more information here! Visit our website for assistance with questions about device connectivity issues, app operation problems, and much more.

<https://olafuslife.com/paes/bc60m051-us-faq-videos>



Manufacturer/Hersteller:
HK JW Illumination Co., Limited
Address/Adresse: Unit 616, 6/f., Kam Teem Industrial Building, 135 Connaught Road West, Sai Wan Hong Kong
Email: support@olafuslife.com

UK Importer: MDH LIGHTING LTD
Address: 69 Aberdeen Avenue, Cambridge CB2 8DL, United Kingdom

EC REP
MDH LIGHTING LTD
Address/Adresse: Suite 302, 292 Strovolos Avenue, 2048 Strovolos Nicosia, Cyprus
Email: service-MDHEU@hotmail.com

Made in China

www.olafuslife.com

