

FCC PART 15C
Measurement and Test Report
For
Shenzhen Lanbiyi Technology Co., Ltd

FCC ID: 2BGZP-LX-09

| | |
|--|---|
| RSS Rule(s)/Methods: | FCC CFR Title 47 Part 15 Subpart C Section 15.247 ANSI C63.10:2013 |
| Product Description: | Wireless music headphones |
| Trademark | N/A |
| Model/Type reference.: | LX-09, BY99, BY08, BY33, BY18, BY17, BY38, BY09, BY66, BY39, BY72, BY77, BY88, BY86, BY27, BY29, BY06, BY10, BY11, BY13 |
| Report No.: | BSL2406120275095F-1 |
| Date of receipt of test item: | May 28, 2024 |
| Date of sampling : | May 29, 2024 |
| Tested Date: | Jun 11, 2024 to Jun 25, 2024 |
| Issued Date: | Jun 26, 2024 |
| Tested By: | Lris Yao/ Engineer <i>Lris Yao</i> |
| Reviewed By: | Levi Xiao/ EMC Manager <i>Levi Xiao</i> |
| Approved & Authorized By: | Salon Ouyang / PSQ Manager <i>Salon Ouyang</i> |
| BSL Testing Co.,LTD. | |
| 1/F, Building B, Xinshidai GR Park, Shiyuan Street, Bao'an District, Shenzhen, Shiyuan Street, Bao'an District, Shenzhen, Guangdong, 518052, People' s Republic of China Tel: 400-882-9628 Fax: 86- 755-26508703 | |

| | Page |
|---|-------------|
| 1. VERSION | 4 |
| 2. TEST SUMMARY | 5 |
| 2.1 TEST FACILITY | 6 |
| 2.2 MEASUREMENT UNCERTAINTY | 6 |
| 3. GENERAL INFORMATION | 7 |
| 3.1 GENERAL DESCRIPTION OF EUT | 7 |
| 3.2 Test Setup Configuration | 8 |
| 3.3 Support Equipment | 9 |
| 3.4 Test Mode | 10 |
| 3.5 EQUIPMENTS LIST FOR ALL TEST ITEMS | 11 |
| 4. EMC EMISSION TEST | 11 |
| 4.1 Conducted emissions | 13 |
| 4.1.1 POWER LINE CONDUCTED EMISSION Limits | 13 |
| 4.1.2 TEST PROCEDURE | 13 |
| 4.1.3 DEVIATION FROM TEST STANDARD | 13 |
| 4.1.4 TEST SETUP | 14 |
| 4.1.5 EUT OPERATING CONDITIONS | 14 |
| 4.1.6 Test Result | 15 |
| 4.2 Radiated emissions | 17 |
| 4.2.1 Radiated Emission Limits | 17 |
| 4.2.2 TEST PROCEDURE | 17 |
| 4.2.3 DEVIATION FROM TEST STANDARD | 18 |
| 4.2.4 TEST SETUP | 18 |
| 4.2.5 EUT OPERATING CONDITIONS | 19 |
| 4.2.6 TEST RESULTS | 20 |
| 5. RADIATED BAND EMISSION MEASUREMENT | 29 |
| 5.1 Test Requirement: | 29 |
| 5.2 TEST PROCEDURE | 29 |
| 5.3 DEVIATION FROM TEST STANDARD | 30 |
| 5.4 TEST SETUP | 30 |
| 5.5 EUT OPERATING CONDITIONS | 30 |
| 5.6 TEST RESULT | 31 |
| 6. CONDUCTED BAND EDGE AND SPURIOUS EMISSION | 35 |
| 6.1 Limit | 35 |
| 6.2 Test Setup | 35 |
| 6.3 Test procedure | 35 |
| 6.4 DEVIATION FROM STANDARD | 35 |
| 6.5 Test Result | 36 |
| 7. 20DB&99% BANDWIDTH | 57 |
| 7.1 Test Setup | 57 |
| 7.2 Limit | 57 |
| 7.3 Test procedure | 57 |

7.4 DEVIATION FROM STANDARD 57

7.5 Test Result 57

8. MAXIMUM PEAK OUTPUT POWER 63

8.1 Block Diagram Of Test Setup 63

8.2 Limit 63

8.3 Test procedure 63

8.4 DEVIATION FROM STANDARD 63

8.5 Test Result 63

9. HOPPING CHANNEL SEPARATION 64

9.1 Test Setup 64

9.2 Test procedure 64

9.3 DEVIATION FROM STANDARD 64

9.4 Test Result 65

10.NUMBER OF HOPPING FREQUENCY70

10.1 Test Setup 70

10.2 Test procedure 70

10.3 DEVIATION FROM STANDARD 70

10.4 Test Result 71

11. DWELL TIME73

11.1 Test Setup 73

11.2 Test procedure 73

11.3 DEVIATION FROM STANDARD 73

11.4 Test Result 74

12. ANTENNA REQUIREMENT 84

13. TEST SETUP PHOTO 84

14. EUT CONSTRUCTIONAL DETAILS84

1. VERSION

| Report No. | Version | Description | Approved |
|---------------------|---------|-------------------------|--------------|
| BSL2406120275095F-1 | Rev.01 | Initial issue of report | Jun 26, 2024 |
| | | | |
| | | | |

2. TEST SUMMARY

Test procedures according to the technical standards:

| FCC Part15 (15.247) , Subpart C KDB 558074 D01 | | | |
|---|---|--------|--------|
| Standard Section | Test Item | Result | Remark |
| 15.203/15.247 (c) | Antenna Requirement | PASS | |
| 15.207 | AC Power Line Conducted Emission | PASS | |
| 15.247 (b)(1) | Conducted Peak Output Power | PASS | |
| 15.247 (a)(1) | 20dB Occupied Bandwidth 99% OCB | PASS | |
| 15.247 (a)(1) | Carrier Frequencies Separation | PASS | |
| 15.247 (a)(1)(iii) | Hopping Channel Number | PASS | |
| 15.247 (a)(1)(iii) | Dwell Time | PASS | |
| 15.205/15.209 | Radiated Emission and Restricted Band | PASS | |
| 15.247(d) | Conducted Unwanted emissions and Band Edge | PASS | |

NOTE:

(1) "N/A" denotes test is not applicable in this Test Report

2.1 TEST FACILITY

BSL TESTING CO., LTD

Add. : 1/F, Building B, Xinshidai GR Park, Shiyao Street, Bao'an District, Shenzhen, Shiyao Street
Bao'an District, Shenzhen, Guangdong, 518052, People' s Republic of China

FCC Test Firm Registration Number: 562200

Designation Number: CN1338

IC Registered No.: 11093A

Designation Number: CN0019

2.2 MEASUREMENT UNCERTAINTY

The reported uncertainty of measurement $y \pm U$, where expanded uncertainty U is based on a standard uncertainty multiplied by a coverage factor of $k=2$, providing a level of confidence of approximately 95%.

| No. | Item | Uncertainty |
|-----|------------------------------|-------------------------|
| 1 | Conducted Emission Test | $\pm 1.38\text{dB}$ |
| 2 | RF power conducted | $\pm 0.16\text{dB}$ |
| 3 | Spurious emissions conducted | $\pm 0.21\text{dB}$ |
| 4 | All emissions radiated(<1G) | $\pm 4.68\text{dB}$ |
| 5 | All emissions radiated(>1G) | $\pm 4.89\text{dB}$ |
| 6 | Temperature | $\pm 0.5^\circ\text{C}$ |
| 7 | Humidity | $\pm 2\%$ |

3. GENERAL INFORMATION**3.1 GENERAL DESCRIPTION OF EUT**

| | |
|--------------------------|---|
| Applicant: | Shenzhen Lanbiyi Technology Co., Ltd |
| Address of applicant: | 1102 Yonghui International Business Building, Baoyuan Road, Baoan District, Shenzhen |
| Manufacturer: | Shenzhen Lanbiyi Technology Co., Ltd |
| Address of manufacturer: | 1102 Yonghui International Business Building, Baoyuan Road, Baoan District, Shenzhen |
| Product Name: | Wireless music headphones |
| Model No.: | LX-09, BY99, BY08, BY33, BY18, BY17, BY38, BY09, BY66, BY39, BY72, BY77, BY88, BY86, BY27, BY29, BY06, BY10, BY11, BY13 |
| Trade Mark: | N/A |
| Hardware version : | V1.0 |
| Software version : | V1.0 |
| Model Different.: | N/A |
| Sample ID | N/A |
| Sample(s) Status: | Engineer sample |
| Channel numbers: | 79 |
| Operation Frequency: | 2402MHz~2480MHz |
| Modulation technology: | GFSK, $\pi/4$ -DQPSK, 8-DPSK |
| Antenna Type: | PCB Antenna |
| Antenna gain: | -1.2dBi |
| Power supply: | DC 5V from USB port Battery: DC 3.7V, 50mAh |

| Operation Frequency each of channel | | | | | | | |
|-------------------------------------|-----------|---------|-----------|---------|-----------|---------|-----------|
| Channel | Frequency | Channel | Frequency | Channel | Frequency | Channel | Frequency |
| 1 | 2402MHz | 21 | 2422MHz | 41 | 2442MHz | 61 | 2462MHz |
| 2 | 2403MHz | 22 | 2423MHz | 42 | 2443MHz | 62 | 2463MHz |
| 3 | 2404MHz | 23 | 2424MHz | 43 | 2444MHz | 63 | 2464MHz |
| 4 | 2405MHz | 24 | 2425MHz | 44 | 2445MHz | 64 | 2465MHz |
| 5 | 2406MHz | 25 | 2426MHz | 45 | 2446MHz | 65 | 2466MHz |
| 6 | 2407MHz | 26 | 2427MHz | 46 | 2447MHz | 66 | 2467MHz |
| 7 | 2408MHz | 27 | 2428MHz | 47 | 2448MHz | 67 | 2468MHz |
| 8 | 2409MHz | 28 | 2429MHz | 48 | 2449MHz | 68 | 2469MHz |
| 9 | 2410MHz | 29 | 2430MHz | 49 | 2450MHz | 69 | 2470MHz |
| 10 | 2411MHz | 30 | 2431MHz | 50 | 2451MHz | 70 | 2471MHz |
| 11 | 2412MHz | 31 | 2432MHz | 51 | 2452MHz | 71 | 2472MHz |
| 12 | 2413MHz | 32 | 2433MHz | 52 | 2453MHz | 72 | 2473MHz |

| | | | | | | | |
|----|---------|----|---------|----|---------|----|---------|
| 13 | 2414MHz | 33 | 2434MHz | 53 | 2454MHz | 73 | 2474MHz |
| 14 | 2415MHz | 34 | 2435MHz | 54 | 2455MHz | 74 | 2475MHz |
| 15 | 2416MHz | 35 | 2436MHz | 55 | 2456MHz | 75 | 2476MHz |
| 16 | 2417MHz | 36 | 2437MHz | 56 | 2457MHz | 76 | 2477MHz |
| 17 | 2418MHz | 37 | 2438MHz | 57 | 2458MHz | 77 | 2478MHz |
| 18 | 2419MHz | 38 | 2439MHz | 58 | 2459MHz | 78 | 2479MHz |
| 19 | 2420MHz | 39 | 2440MHz | 59 | 2460MHz | 79 | 2480MHz |
| 20 | 2421MHz | 40 | 2441MHz | 60 | 2461MHz | | |

All Bluetooth units participating in the piconet are time and hop-synchronized to the channel.

Example of a 79 hopping sequence in data mode:

35, 27, 6, 44, 14, 61, 74, 32, 1, 11, 23, 2, 55, 65, 29, 3, 9, 52, 78, 58, 40, 25, 0, 7, 18, 26, 76, 60, 47, 50, 2, 5, 16, 37, 70, 63, 66, 54, 20, 13, 4, 8, 15, 21, 26, 10, 73, 77, 67, 69, 43, 24, 57, 39, 46, 72, 48, 33, 17, 31, 75, 19, 41, 62, 68, 28, 51, 66, 30, 56, 34, 59, 71, 22, 49, 64, 38, 45, 36, 53, 42

Each Frequency used equally on the average by each transmitter

Note:

In section 15.31(m), regards to the operating frequency range over 10 MHz, the Lowest frequency, the middle frequency, and the highest frequency of channel were selected to perform the test, and the selected channel see below:

| Test channel | Frequency |
|---------------------|-----------|
| The lowest channel | 2402MHz |
| The middle channel | 2441MHz |
| The Highest channel | 2480MHz |

Note:This EUT supports DH1/DH3/DH5/2DH1/2DH3/2DH5/3DH1/3DH3/3DH5, Only DH5/2DH5/3DH5 record in this report

3.2 Test Setup Configuration

Conducted Emission



Radiated Emission



Conducted Spurious

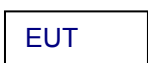

3.3 Support Equipment

The EUT has been tested as an independent unit together with other necessary accessories or support units. The following support units or accessories were used to form a representative test configuration during the tests.

| Item | Equipment | Mfr/Brand | Model/Type No. | Series No. | Note |
|------|-----------|-----------|----------------|------------|----------|
| / | ADAPTER | / | ADS-5001000C | / | DC 5V/1A |
| | | | | | |
| | | | | | |

| Item | Shielded Type | Ferrite Core | Length | Note |
|------|---------------|--------------|--------|------|
| | | | | |

Note:

- (1) The support equipment was authorized by Declaration of Confirmation.
- (2) For detachable type I/O cable should be specified the length in cm in 『Length』 column.

3.4 Test Mode

| | |
|---|---|
| Transmitting mode | Keep the EUT in continuously transmitting mode. |
| Remark: During the test, the test voltage was tuned from 85% to 115% of the nominal rated supply voltage, and found that the worst case was under the nominal rated supply condition. So the report just shows that condition's data. | |

| | |
|-------------------|--------------|
| Test Software | BT Test Tool |
| Power level setup | 2dBm |

3.5 EQUIPMENTS LIST FOR ALL TEST ITEMS

Radiation Test equipment

| Item | Equipment | Manufacturer | Type No. | Serial No. | Last calibration | Calibrated until |
|------|-------------------------------------|------------------|--------------------|-------------------------------------|------------------|------------------|
| 1 | Communication Tester | Rohde & Schwarz | CMW500 | 100358 Fireware: 4.43 SP4 | Oct. 22, 2023 | Oct. 21, 2024 |
| 2 | Spectrum Analyzer | KEYSIGHT | 9020A | MY55370835 | Oct. 22, 2023 | Oct. 21, 2024 |
| 3 | Test Receiver | R&S | ESC17 | US47140102 Fireware: 4.42 SP3 | Oct. 22, 2023 | Oct. 21, 2024 |
| 4 | Signal Generator | HP | 83630B | 3844A01028 | Oct. 22, 2023 | Oct. 21, 2024 |
| 5 | Signal Generator | IFR | 2023A | 202307/242 | Oct. 22, 2023 | Oct. 21, 2024 |
| 6 | Amplifier | Agilent | 8449B | 4035A00116 | Oct. 22, 2023 | Oct. 21, 2024 |
| 7 | Amplifier | HP | 8447E | 2945A02770 | Oct. 22, 2023 | Oct. 21, 2024 |
| 8 | Broadband Antenna | SCHAFFNER | 2774 | 2774 | Feb.28,2022 | Feb.27,2025 |
| 9 | Biconical and log periodic antennas | ELECTRO-METRICS | EM-6917B-1 | 171 | Feb.28,2022 | Feb.27,2025 |
| 10 | Horn Antenna | R&S | HF906 | 100253 | Feb.28,2022 | Feb.27,2025 |
| 11 | Horn Antenna | Schwarzbeck | BBHA9170 | 00814 | Feb.28,2022 | Feb.27,2025 |
| 12 | Horn Antenna | EM | EM-6961 | 6462 | Feb.28,2022 | Feb.27,2025 |
| 13 | 3m Semi-Anechoic Chamber | Chengyu Electron | 9 (L)*6 (W)* 6 (H) | BSL086 | Feb.28,2022 | Feb.27,2025 |
| 14 | Loop Antenna | ZHINAN | ZN30900C | 20073 | Feb.28,2022 | Feb.27,2025 |
| 15 | power meter | DARE | RPR3006W | 15I00041SNO0 | Oct.27,2023 | Oct.26,2024 |
| 16 | RF Control Unit | MWRFtest | Mw100 | - | Oct.27,2023 | Oct.26,2024 |
| 17 | Test software | MWRFtest | V8310 | - | - | - |
| 18 | Turntable | MF | MF-7802BS | N/A | \ | \ |

Conduction Test equipment

| Item | Kind of Equipment | Manufacturer | Type No. | Serial No. | Last calibration | Calibrated until |
|------|-------------------|--------------|----------|----------------------|------------------|------------------|
| 1 | LISN | R&S | ENV216 | 101471 | Oct.27,2023 | Oct.26,2024 |
| 2 | LISN | CYBERTEK | EM5040A | E1850400149 | Oct.27,2023 | Oct.26,2024 |
| 3 | Test Cable | N/A | C01 | N/A | Oct.27,2023 | Oct.26,2024 |
| 4 | Test Cable | N/A | C02 | N/A | Oct.27,2023 | Oct.26,2024 |
| 5 | EMI Test Receiver | R&S | ESC13 | 101393 | Oct.27,2023 | Oct.26,2024 |
| 6 | Absorbing Clamp | DZ | ZN23201 | 15034 | Oct.27,2023 | Oct.26,2024 |
| 7 | EMC Software | Frad | EZ-EMC | Ver.EMC-CON 3A1.1 | \ | \ |

RF Conduction Test equipment

| Item | Kind of Equipment | Manufacturer | Type No. | Serial No. | Last calibration | Calibrated until |
|------|-------------------------------------|--------------|------------|------------|------------------|------------------|
| 1 | Spectrum Analyzer (9kHz-26.5GHz) | KEYSIGHT | 9020A | MY55370835 | Oct.27,2023 | Oct.26,2024 |
| 2 | MWRF Power Meter Test system | MW | MW100-RPCB | N/A | Oct.27,2023 | Oct.26,2024 |
| 3 | D.C. Power Supply | LongWei | TPR-6405D | N/A | \ | \ |
| 4 | RF Software | MW | MTS8310 | V2.0.0.0 | \ | \ |

4. EMC EMISSION TEST

4.1 Conducted emissions

| | |
|-----------------------|--------------------------------------|
| Test Requirement: | FCC Part15 C Section 15.207 |
| Test Method: | ANSI C63.10:2013 |
| Test Frequency Range: | 150KHz to 30MHz |
| Receiver setup: | RBW=9KHz, VBW=30KHz, Sweep time=auto |

4.1.1 POWER LINE CONDUCTED EMISSION Limits

| FREQUENCY (MHz) | Limit (dBuV) | | Standard |
|-----------------|--------------|-----------|----------|
| | Quasi-peak | Average | |
| 0.15 -0.5 | 66 - 56 * | 56 - 46 * | FCC |
| 0.50 -5.0 | 56.00 | 46.00 | FCC |
| 5.0 -30.0 | 60.00 | 50.00 | FCC |

Note:

(1) *Decreases with the logarithm of the frequency.

4.1.2 TEST PROCEDURE

- a. The EUT was placed 0.8 meters from the horizontal ground plane with EUT being connected to the power mains through a line impedance stabilization network (LISN). All other support equipments powered from additional LISN(s). The LISN provide 50 Ohm/ 50uH of coupling impedance for the measuring instrument.
- b. Interconnecting cables that hang closer than 40 cm to the ground plane shall be folded back and forth in the center forming a bundle 30 to 40 cm long.
- c. I/O cables that are not connected to a peripheral shall be bundled in the center. The end of the cable may be terminated, if required, using the correct terminating impedance. The overall length shall not exceed 1 m.
- d. LISN at least 80 cm from nearest part of EUT chassis.
- e. For the actual test configuration, please refer to the related Item –EUT Test Photos.

4.1.3 DEVIATION FROM TEST STANDARD

No deviation

4.1.4 TEST SETUP

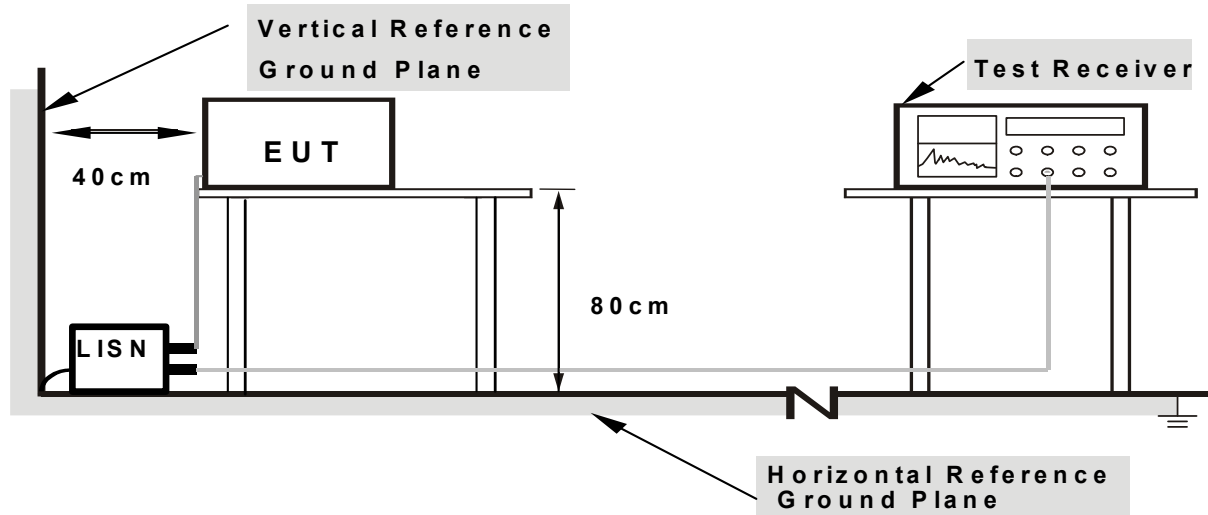

- Note:**
- 1.Support units were connected to second LISN.
 - 2.Both of LISNs (AMN) are 80 cm from EUT and at least 80 from other units and other metal planes

4.1.5 EUT OPERATING CONDITIONS

The EUT was configured for testing in a typical fashion (as a customer would normally use it). The EUT has been programmed to continuously transmit during test. This operating condition was tested and used to collect the included data.

We pretest AC 120V and AC 230V, the worst voltage was AC 120V and the data recording in the report.

4.1.6 Test Result (Worst case GFSK 2402MHz)

| | | | |
|----------------|--------------|--------------------|-----|
| Temperature : | 26°C | Relative Humidity: | 54% |
| Pressure : | 101kPa | Phase : | L |
| Test Voltage : | AC 120V/60Hz | | |

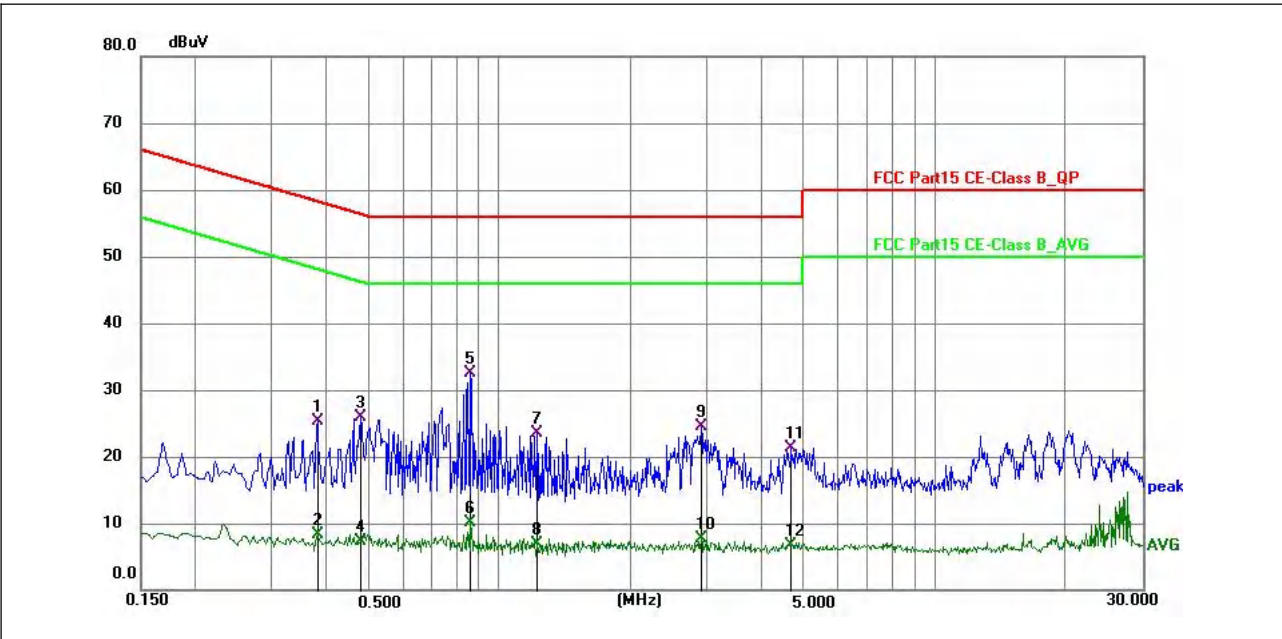

| No. | Frequency (MHz) | Reading (dBuV) | Factor (dB) | Level (dBuV) | Limit (dBuV) | Margin (dB) | Detector | P/F | Remark |
|-----|-----------------|----------------|-------------|--------------|--------------|-------------|----------|-----|--------|
| 1 | 0.3795 | 15.66 | 9.65 | 25.31 | 58.29 | -32.98 | QP | P | |
| 2 | 0.3795 | -1.31 | 9.65 | 8.34 | 48.29 | -39.95 | AVG | P | |
| 3 | 0.4785 | 16.26 | 9.62 | 25.88 | 56.37 | -30.49 | QP | P | |
| 4 | 0.4785 | -2.29 | 9.62 | 7.33 | 46.37 | -39.04 | AVG | P | |
| 5 * | 0.8565 | 22.88 | 9.62 | 32.50 | 56.00 | -23.50 | QP | P | |
| 6 | 0.8565 | 0.42 | 9.62 | 10.04 | 46.00 | -35.96 | AVG | P | |
| 7 | 1.2164 | 13.96 | 9.56 | 23.52 | 56.00 | -32.48 | QP | P | |
| 8 | 1.2164 | -2.68 | 9.56 | 6.88 | 46.00 | -39.12 | AVG | P | |
| 9 | 2.9085 | 14.82 | 9.63 | 24.45 | 56.00 | -31.55 | QP | P | |
| 10 | 2.9085 | -1.90 | 9.63 | 7.73 | 46.00 | -38.27 | AVG | P | |
| 11 | 4.6860 | 11.76 | 9.53 | 21.29 | 56.00 | -34.71 | QP | P | |
| 12 | 4.6860 | -2.78 | 9.53 | 6.75 | 46.00 | -39.25 | AVG | P | |

Notes:

- 1.An initial pre-scan was performed on the line and neutral lines with peak detector.
- 2.Quasi-Peak and Average measurement were performed at the frequencies with maximized peak emission.
- 3.Measurement Level = Reading level + Correct Factor

| | | | |
|----------------|--------------|--------------------|-----|
| Temperature : | 26°C | Relative Humidity: | 54% |
| Pressure : | 101kPa | Phase : | N |
| Test Voltage : | AC 120V/60Hz | | |

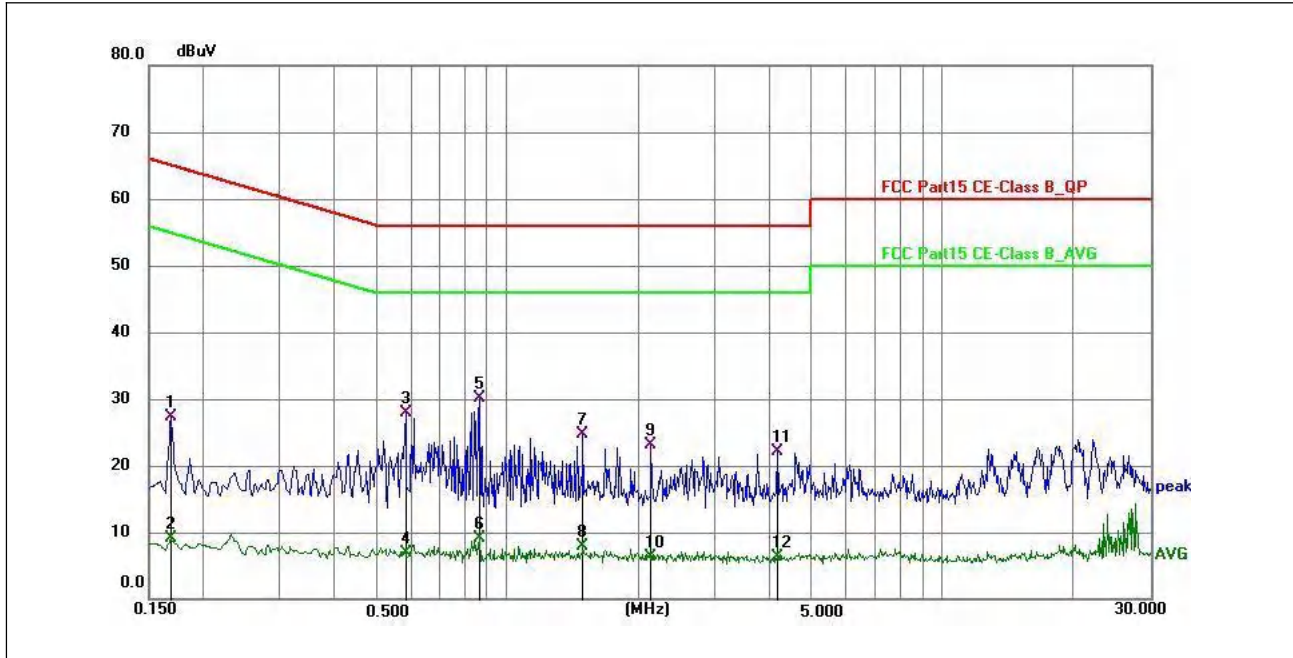

| No. | Frequency (MHz) | Reading (dBuV) | Factor (dB) | Level (dBuV) | Limit (dBuV) | Margin (dB) | Detector | P/F | Remark |
|-----|-----------------|----------------|-------------|--------------|--------------|-------------|----------|-----|--------|
| 1 | 0.1680 | 17.65 | 9.58 | 27.23 | 65.06 | -37.83 | QP | P | |
| 2 | 0.1680 | -0.53 | 9.58 | 9.05 | 55.06 | -46.01 | AVG | P | |
| 3 | 0.5819 | 18.26 | 9.66 | 27.92 | 56.00 | -28.08 | QP | P | |
| 4 | 0.5819 | -2.66 | 9.66 | 7.00 | 46.00 | -39.00 | AVG | P | |
| 5 * | 0.8655 | 20.56 | 9.61 | 30.17 | 56.00 | -25.83 | QP | P | |
| 6 | 0.8655 | -0.49 | 9.61 | 9.12 | 46.00 | -36.88 | AVG | P | |
| 7 | 1.4910 | 15.17 | 9.62 | 24.79 | 56.00 | -31.21 | QP | P | |
| 8 | 1.4910 | -1.76 | 9.62 | 7.86 | 46.00 | -38.14 | AVG | P | |
| 9 | 2.1345 | 13.37 | 9.71 | 23.08 | 56.00 | -32.92 | QP | P | |
| 10 | 2.1345 | -3.38 | 9.71 | 6.33 | 46.00 | -39.67 | AVG | P | |
| 11 | 4.1595 | 12.62 | 9.53 | 22.15 | 56.00 | -33.85 | QP | P | |
| 12 | 4.1595 | -3.14 | 9.53 | 6.39 | 46.00 | -39.61 | AVG | P | |

Notes:

1. An initial pre-scan was performed on the line and neutral lines with peak detector.
2. Quasi-Peak and Average measurement were performed at the frequencies with maximized peak emission.
3. Measurement Level = Reading level + Correct Factor

4.2 Radiated emissions

| | | | | | |
|-----------------------|-----------------------------|------------|--------|--------|------------|
| Test Requirement: | FCC Part15 C Section 15.209 | | | | |
| Test Method: | ANSI C63.10:2013 | | | | |
| Test Frequency Range: | 9kHz to 25GHz | | | | |
| Test site: | Measurement Distance: 3m | | | | |
| Receiver setup: | Frequency | Detector | RBW | VBW | Value |
| | 9KHz-150KHz | Quasi-peak | 200Hz | 600Hz | Quasi-peak |
| | 150KHz-30MHz | Quasi-peak | 9KHz | 30KHz | Quasi-peak |
| | 30MHz-1GHz | Quasi-peak | 100KHz | 300KHz | Quasi-peak |
| | Above 1GHz | Peak | 1MHz | 3MHz | Peak |
| | | Peak | 1MHz | 10Hz | Average |

4.2.1 Radiated Emission Limits

| Frequencies (MHz) | Field Strength (micorvolts/meter) | Measurement Distance (meters) |
|-------------------|-----------------------------------|-------------------------------|
| 0.009~0.490 | 2400/F(KHz) | 300 |
| 0.490~1.705 | 24000/F(KHz) | 30 |
| 1.705~30.0 | 30 | 30 |
| 30~88 | 100 | 3 |
| 88~216 | 150 | 3 |
| 216~960 | 200 | 3 |
| Above 960 | 500 | 3 |

LIMITS OF RADIATED EMISSION MEASUREMENT

| FREQUENCY (MHz) | Limit (dBuV/m) (at 3M) | |
|-----------------|------------------------|---------|
| | PEAK | AVERAGE |
| Above 1000 | 74 | 54 |

Notes:

- (1) The limit for radiated test was performed according to FCC PART 15C.
- (2) The tighter limit applies at the band edges.
- (3) Emission level (dBuV/m)=20log Emission level (uV/m).

4.2.2 TEST PROCEDURE

Below 1GHz test procedure as below:

- a. The EUT was placed on the top of a rotating table 0.1 meters above the ground at a 3 meter semi-anechoic chamber. The table was rotated 360 degrees to determine the position of the highest radiation.
- b. The EUT was set 3 meters away from the interference-receiving antenna, which was mounted on the top of a variable-height antenna tower.
- c. The antenna height is varied from one meter to four meters above the ground to determine the maximum value of the field strength. Both horizontal and vertical polarizations of the antenna are set to make the measurement.

- d. For each suspected emission, the EUT was arranged to its worst case and then the antenna was tuned to heights from 1 meter to 4 meters (for the test frequency of below 30MHz, the antenna was tuned to heights 1 meter) and the rotatable table was turned from 0 degrees to 360 degrees to find the maximum reading.
- e. The test-receiver system was set to Peak Detect Function and Specified Bandwidth with Maximum Hold Mode.
- f. If the emission level of the EUT in peak mode was 10dB lower than the limit specified, then testing could be stopped and the peak values of the EUT would be reported. Otherwise the emissions that did not have 10dB margin would be re-tested one by one using peak, quasi-peak or average method as specified and then reported in a data sheet.

Above 1GHz test procedure as below:

- g. Different between above is the test site, change from Semi- Anechoic Chamber to fully Anechoic Chamber and change form table 0.8 metre to 1.5 metre(Above 18GHz the distance is 1 meter and table is 1.5 metre).
- h. Test the EUT in the lowest channel ,the middle channel ,the Highest channel

Note:

Both horizontal and vertical antenna polarities were tested and performed pretest to three orthogonal axis. The worst case emissions were reported

4.2.3 DEVIATION FROM TEST STANDARD

No deviation

4.2.4 TEST SETUP

(A) Radiated Emission Test-Up Frequency Below 30MHz

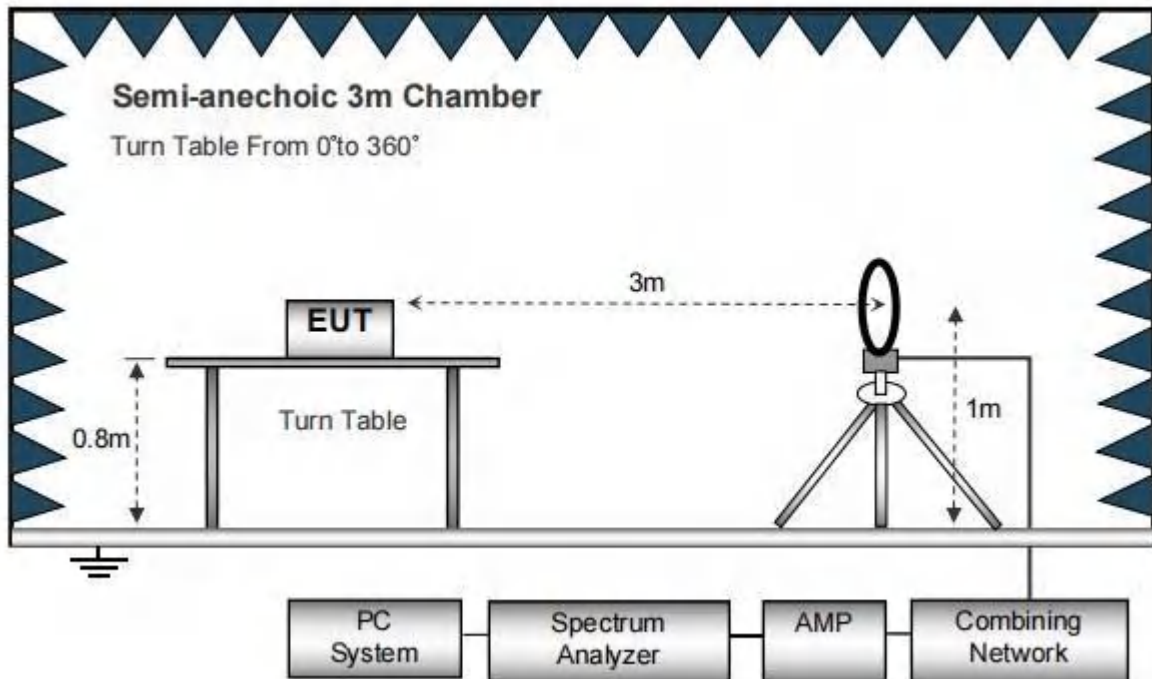

(B) Radiated Emission Test-Up Frequency 30MHz~1GHz

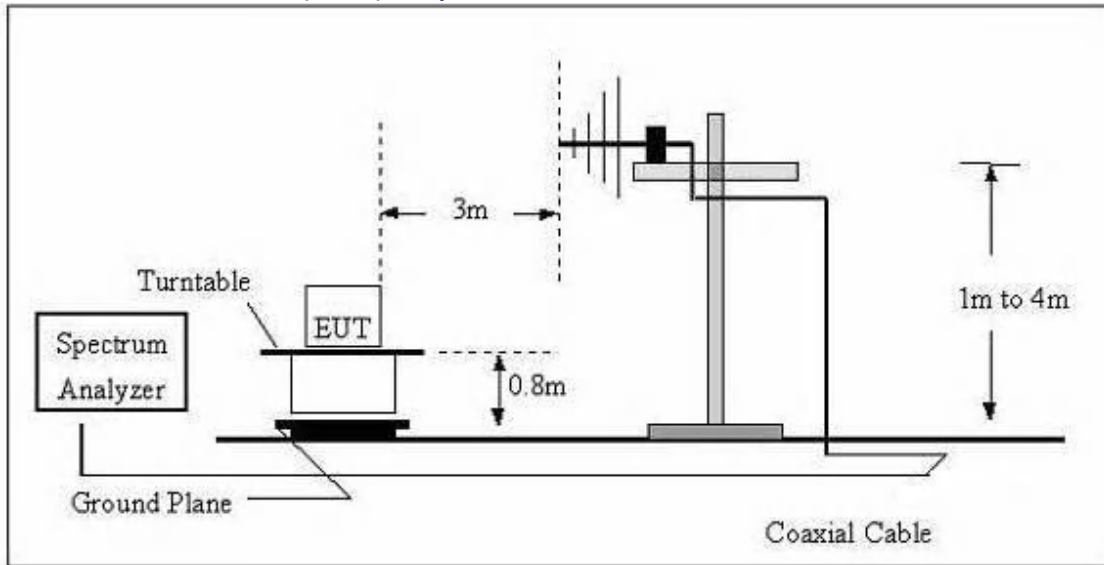

(C) Radiated Emission Test-Up Frequency Above 1GHz

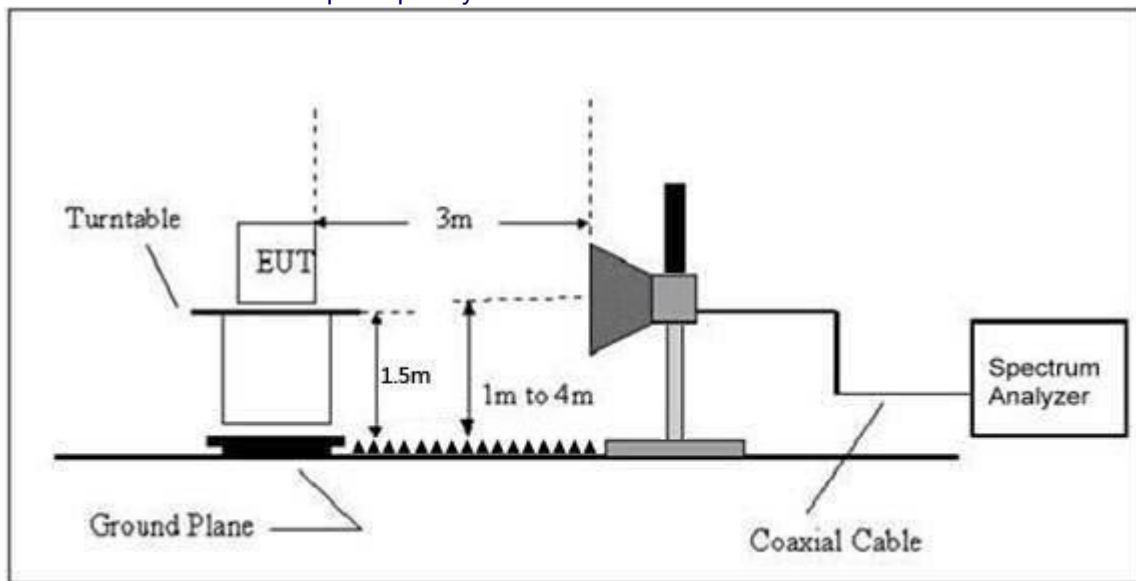

4.2.5 EUT OPERATING CONDITIONS

The EUT tested system was configured as the statements of 2.4 Unless otherwise a special operating condition is specified in the follows during the testing.

4.2.6 TEST RESULTS

Between 9KHz – 30MHz

The emission from 9 kHz to 30MHz was pre-tested and found the result was 20dB lower than the limit, and according to 15.31(o) & RSS-Gen 6.13, the test result no need to reported.

Between 30MHz – 1GHz (Worst case GFSK 2402MHz)

| | | | |
|---------------|---------|--------------------|------------|
| Temperature: | 26°C | Relative Humidity: | 54% |
| Pressure: | 101 kPa | Polarization: | Horizontal |
| Test Voltage: | DC 3.7V | | |

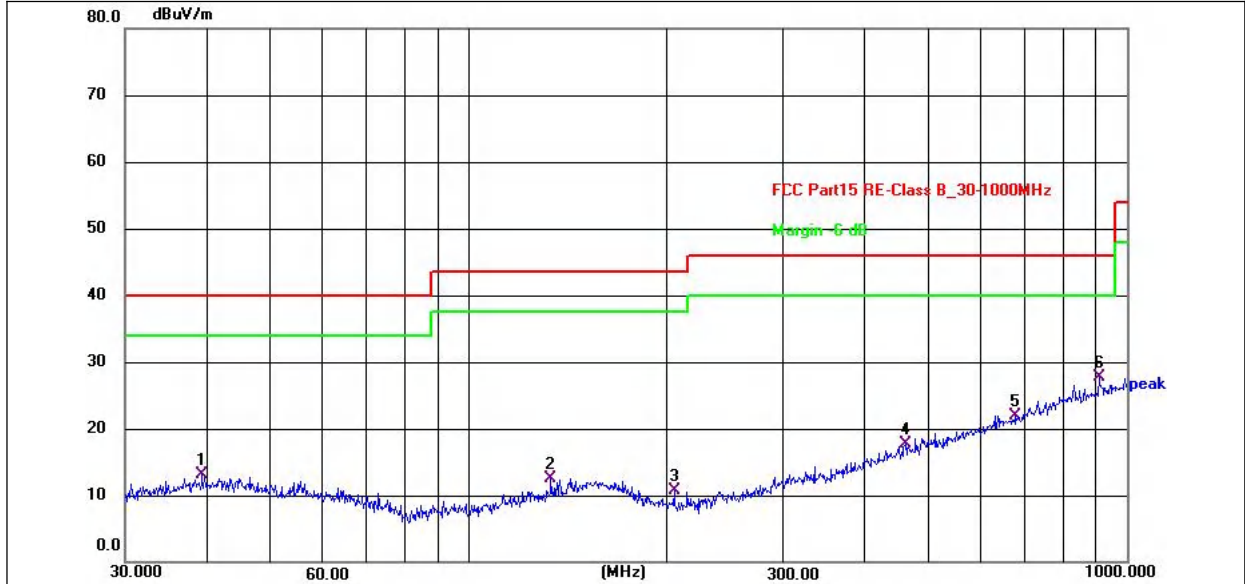

| No. | Frequency (MHz) | Reading (dBuV) | Factor (dB/m) | Level (dBuV/m) | Limit (dBuV/m) | Margin (dB) | Detector |
|-----|-----------------|----------------|---------------|----------------|----------------|-------------|----------|
| 1 | 39.2991 | 28.88 | -15.80 | 13.08 | 40.00 | -26.92 | QP |
| 2 | 133.1511 | 29.79 | -17.38 | 12.41 | 43.50 | -31.09 | QP |
| 3 | 204.9551 | 29.72 | -19.11 | 10.61 | 43.50 | -32.89 | QP |
| 4 | 460.7271 | 29.32 | -11.64 | 17.68 | 46.00 | -28.32 | QP |
| 5 | 677.5798 | 29.11 | -7.16 | 21.95 | 46.00 | -24.05 | QP |
| 6 * | 906.4824 | 31.18 | -3.49 | 27.69 | 46.00 | -18.31 | QP |

| | | | |
|---------------|---------|--------------------|----------|
| Temperature: | 26°C | Relative Humidity: | 54% |
| Pressure: | 101kPa | Polarization: | Vertical |
| Test Voltage: | DC 3.7V | | |

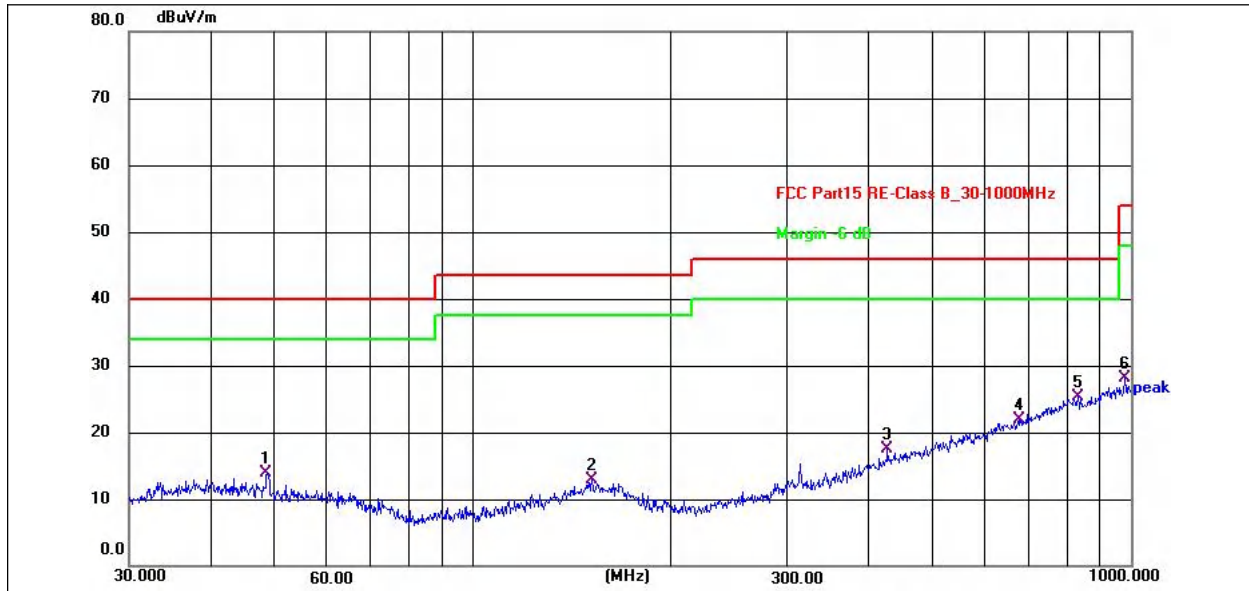

| No. | Frequency (MHz) | Reading (dBuV) | Factor (dB/m) | Level (dBuV/m) | Limit (dBuV/m) | Margin (dB) | Detector |
|-----|-----------------|----------------|---------------|----------------|----------------|-------------|----------|
| 1 | 48.6719 | 30.25 | -16.44 | 13.81 | 40.00 | -26.19 | QP |
| 2 | 151.5972 | 28.68 | -15.80 | 12.88 | 43.50 | -30.62 | QP |
| 3 | 426.5210 | 29.99 | -12.49 | 17.50 | 46.00 | -28.50 | QP |
| 4 | 675.2080 | 29.02 | -7.21 | 21.81 | 46.00 | -24.19 | QP |
| 5 * | 830.4002 | 29.75 | -4.35 | 25.40 | 46.00 | -20.60 | QP |
| 6 | 979.1804 | 30.39 | -2.27 | 28.12 | 54.00 | -25.88 | QP |

Remarks:

1. Final Level = Receiver Read level + Antenna Factor + Cable Loss
2. The emission levels of other frequencies are very lower than the limit and not show in test report.
3. The test data shows only the worst case GFSK mode

1GHz~25GHz

GFSK

| Polar (H/V) | Frequency | Meter Reading | Pre-ampli fier | Cable Loss | Antenna Factor | Emission Level | Limits | Margin | Detector Type |
|---------------------|-----------|------------------|-------------------|---------------|-------------------|-------------------|----------|--------|------------------|
| | (MHz) | (dBuV) | (dB) | (dB) | (dB) | (dBuV/m) | (dBuV/m) | (dB) | |
| Low Channel:2402MHz | | | | | | | | | |
| V | 4804.00 | 53.60 | 30.55 | 5.77 | 24.66 | 53.48 | 74.00 | -20.52 | Pk |
| V | 4804.00 | 43.99 | 30.55 | 5.77 | 24.66 | 43.87 | 54.00 | -10.13 | AV |
| V | 7206.00 | 51.88 | 30.33 | 6.32 | 24.55 | 52.42 | 74.00 | -21.58 | Pk |
| V | 7206.00 | 43.09 | 30.33 | 6.32 | 24.55 | 43.63 | 54.00 | -10.37 | AV |
| V | 9608.00 | 51.82 | 30.85 | 7.45 | 24.69 | 53.11 | 74.00 | -20.89 | Pk |
| V | 9608.00 | 43.62 | 30.85 | 7.45 | 24.69 | 44.91 | 54.00 | -9.09 | AV |
| V | 12010.00 | 52.38 | 31.02 | 8.99 | 25.57 | 55.92 | 74.00 | -18.08 | Pk |
| V | 12010.00 | 43.81 | 31.02 | 8.99 | 25.57 | 47.35 | 54.00 | -6.65 | AV |
| H | 4804.00 | 53.36 | 30.55 | 5.77 | 24.66 | 53.24 | 74.00 | -20.76 | Pk |
| H | 4804.00 | 43.21 | 30.55 | 5.77 | 24.66 | 43.09 | 54.00 | -10.91 | AV |
| H | 7206.00 | 53.60 | 30.33 | 6.32 | 24.55 | 54.14 | 74.00 | -19.86 | Pk |
| H | 7206.00 | 43.22 | 30.33 | 6.32 | 24.55 | 43.76 | 54.00 | -10.24 | AV |
| H | 9608.00 | 51.93 | 30.85 | 7.45 | 24.69 | 53.22 | 74.00 | -20.78 | Pk |
| H | 9608.00 | 43.55 | 30.85 | 7.45 | 24.69 | 44.84 | 54.00 | -9.16 | AV |
| H | 12010.00 | 50.77 | 31.02 | 8.99 | 25.57 | 54.31 | 74.00 | -19.69 | Pk |
| H | 12010.00 | 43.66 | 31.02 | 8.99 | 25.57 | 47.20 | 54.00 | -6.80 | AV |

| Polar (H/V) | Frequency | Meter Reading | Pre-ampli fier | Cable Loss | Antenna Factor | Emission Level | Limits | Margin | Detector Type |
|------------------------|-----------|------------------|-------------------|---------------|-------------------|-------------------|----------|--------|------------------|
| | (MHz) | (dBuV) | (dB) | (dB) | (dB) | (dBuV/m) | (dBuV/m) | (dB) | |
| Middle Channel:2441MHz | | | | | | | | | |
| V | 4882.00 | 54.82 | 30.55 | 5.77 | 24.66 | 54.70 | 74.00 | -19.30 | Pk |
| V | 4882.00 | 43.50 | 30.55 | 5.77 | 24.66 | 43.38 | 54.00 | -10.62 | AV |
| V | 7323.00 | 53.55 | 30.33 | 6.32 | 24.55 | 54.09 | 74.00 | -19.91 | Pk |
| V | 7323.00 | 43.84 | 30.33 | 6.32 | 24.55 | 44.38 | 54.00 | -9.62 | AV |
| V | 9764.00 | 53.76 | 30.85 | 7.45 | 24.69 | 55.05 | 74.00 | -18.95 | Pk |
| V | 9764.00 | 43.64 | 30.85 | 7.45 | 24.69 | 44.93 | 54.00 | -9.07 | AV |
| V | 12205.00 | 53.14 | 31.02 | 8.99 | 25.57 | 56.68 | 74.00 | -17.32 | Pk |
| V | 12205.00 | 43.90 | 31.02 | 8.99 | 25.57 | 47.44 | 54.00 | -6.56 | AV |
| H | 4882.00 | 50.56 | 30.55 | 5.77 | 24.66 | 50.44 | 74.00 | -23.56 | Pk |
| H | 4882.00 | 43.34 | 30.55 | 5.77 | 24.66 | 43.22 | 54.00 | -10.78 | AV |
| H | 7323.00 | 51.65 | 30.33 | 6.32 | 24.55 | 52.19 | 74.00 | -21.81 | Pk |
| H | 7323.00 | 43.17 | 30.33 | 6.32 | 24.55 | 43.71 | 54.00 | -10.29 | AV |
| H | 9764.00 | 52.49 | 30.85 | 7.45 | 24.69 | 53.78 | 74.00 | -20.22 | Pk |
| H | 9764.00 | 43.32 | 30.85 | 7.45 | 24.69 | 44.61 | 54.00 | -9.39 | AV |
| H | 12205.00 | 50.24 | 31.02 | 8.99 | 25.57 | 53.78 | 74.00 | -20.22 | Pk |
| H | 12205.00 | 43.21 | 31.02 | 8.99 | 25.57 | 46.75 | 54.00 | -7.25 | AV |

| Polar (H/V) | Frequency | Meter Reading | Pre-ampli fier | Cable Loss | Antenna Factor | Emission Level | Limits | Margin | Detector Type |
|----------------------|-----------|------------------|-------------------|---------------|-------------------|-------------------|----------|--------|------------------|
| | (MHz) | (dBuV) | (dB) | (dB) | (dB) | (dBuV/m) | (dBuV/m) | (dB) | |
| High Channel:2480MHz | | | | | | | | | |
| V | 4960.00 | 54.02 | 30.55 | 5.77 | 24.66 | 53.90 | 74.00 | -20.10 | Pk |
| V | 4960.00 | 43.51 | 30.55 | 5.77 | 24.66 | 43.39 | 54.00 | -10.61 | AV |
| V | 7440.00 | 54.48 | 30.33 | 6.32 | 24.55 | 55.02 | 74.00 | -18.98 | Pk |
| V | 7440.00 | 43.67 | 30.33 | 6.32 | 24.55 | 44.21 | 54.00 | -9.79 | AV |
| V | 9920.00 | 53.26 | 30.85 | 7.45 | 24.69 | 54.55 | 74.00 | -19.45 | Pk |
| V | 9920.00 | 43.63 | 30.85 | 7.45 | 24.69 | 44.92 | 54.00 | -9.08 | AV |
| V | 12400.00 | 52.23 | 31.02 | 8.99 | 25.57 | 55.77 | 74.00 | -18.23 | Pk |
| V | 12400.00 | 43.98 | 31.02 | 8.99 | 25.57 | 47.52 | 54.00 | -6.48 | AV |
| H | 4960.00 | 52.45 | 30.55 | 5.77 | 24.66 | 52.33 | 74.00 | -21.67 | Pk |
| H | 4960.00 | 43.88 | 30.55 | 5.77 | 24.66 | 43.76 | 54.00 | -10.24 | AV |
| H | 7440.00 | 52.80 | 30.33 | 6.32 | 24.55 | 53.34 | 74.00 | -20.66 | Pk |
| H | 7440.00 | 43.45 | 30.33 | 6.32 | 24.55 | 43.99 | 54.00 | -10.01 | AV |
| H | 9920.00 | 50.25 | 30.85 | 7.45 | 24.69 | 51.54 | 74.00 | -22.46 | Pk |
| H | 9920.00 | 43.73 | 30.85 | 7.45 | 24.69 | 45.02 | 54.00 | -8.98 | AV |
| H | 12400.00 | 50.17 | 31.02 | 8.99 | 25.57 | 53.71 | 74.00 | -20.29 | Pk |
| H | 12400.00 | 43.23 | 31.02 | 8.99 | 25.57 | 46.77 | 54.00 | -7.23 | AV |

Remark:

1. Emission Level = Meter Reading + Antenna Factor + Cable Loss – Pre-amplifier,
Margin= Emission Level - Limit
2. If peak below the average limit, the average emission was no test.
3. The amplitude of spurious emissions which are attenuated by more than 20dB below the permissible value has no need to be reported.

$\pi/4$ -DQPSK

| Polar (H/V) | Frequency | Meter Reading | Pre-ampli fier | Cable Loss | Antenna Factor | Emission Level | Limits | Margin | Detector Type |
|---------------------|-----------|------------------|-------------------|---------------|-------------------|-------------------|----------|--------|------------------|
| | (MHz) | (dBuV) | (dB) | (dB) | (dB) | (dBuV/m) | (dBuV/m) | (dB) | |
| Low Channel:2402MHz | | | | | | | | | |
| V | 4804.00 | 53.54 | 30.55 | 5.77 | 24.66 | 53.42 | 74.00 | -20.58 | Pk |
| V | 4804.00 | 43.07 | 30.55 | 5.77 | 24.66 | 42.95 | 54.00 | -11.05 | AV |
| V | 7206.00 | 52.04 | 30.33 | 6.32 | 24.55 | 52.58 | 74.00 | -21.42 | Pk |
| V | 7206.00 | 43.70 | 30.33 | 6.32 | 24.55 | 44.24 | 54.00 | -9.76 | AV |
| V | 9608.00 | 51.21 | 30.85 | 7.45 | 24.69 | 52.50 | 74.00 | -21.50 | Pk |
| V | 9608.00 | 43.67 | 30.85 | 7.45 | 24.69 | 44.96 | 54.00 | -9.04 | AV |
| V | 12010.00 | 54.49 | 31.02 | 8.99 | 25.57 | 58.03 | 74.00 | -15.97 | Pk |
| V | 12010.00 | 43.13 | 31.02 | 8.99 | 25.57 | 46.67 | 54.00 | -7.33 | AV |
| H | 4804.00 | 51.00 | 30.55 | 5.77 | 24.66 | 50.88 | 74.00 | -23.12 | Pk |
| H | 4804.00 | 43.52 | 30.55 | 5.77 | 24.66 | 43.40 | 54.00 | -10.60 | AV |
| H | 7206.00 | 53.60 | 30.33 | 6.32 | 24.55 | 54.14 | 74.00 | -19.86 | Pk |
| H | 7206.00 | 43.30 | 30.33 | 6.32 | 24.55 | 43.84 | 54.00 | -10.16 | AV |
| H | 9608.00 | 54.44 | 30.85 | 7.45 | 24.69 | 55.73 | 74.00 | -18.27 | Pk |
| H | 9608.00 | 43.87 | 30.85 | 7.45 | 24.69 | 45.16 | 54.00 | -8.84 | AV |
| H | 12010.00 | 54.74 | 31.02 | 8.99 | 25.57 | 58.28 | 74.00 | -15.72 | Pk |
| H | 12010.00 | 43.22 | 31.02 | 8.99 | 25.57 | 46.76 | 54.00 | -7.24 | AV |

| Polar (H/V) | Frequency | Meter Reading | Pre-ampli fier | Cable Loss | Antenna Factor | Emission Level | Limits | Margin | Detector Type |
|------------------------|-----------|------------------|-------------------|---------------|-------------------|-------------------|----------|--------|------------------|
| | (MHz) | (dBuV) | (dB) | (dB) | (dB) | (dBuV/m) | (dBuV/m) | (dB) | |
| Middle Channel:2441MHz | | | | | | | | | |
| V | 4882.00 | 51.71 | 30.55 | 5.77 | 24.66 | 51.59 | 74.00 | -22.41 | Pk |
| V | 4882.00 | 43.79 | 30.55 | 5.77 | 24.66 | 43.67 | 54.00 | -10.33 | AV |
| V | 7323.00 | 51.36 | 30.33 | 6.32 | 24.55 | 51.90 | 74.00 | -22.10 | Pk |
| V | 7323.00 | 43.14 | 30.33 | 6.32 | 24.55 | 43.68 | 54.00 | -10.32 | AV |
| V | 9764.00 | 50.35 | 30.85 | 7.45 | 24.69 | 51.64 | 74.00 | -22.36 | Pk |
| V | 9764.00 | 43.76 | 30.85 | 7.45 | 24.69 | 45.05 | 54.00 | -8.95 | AV |
| V | 12205.00 | 50.58 | 31.02 | 8.99 | 25.57 | 54.12 | 74.00 | -19.88 | Pk |
| V | 12205.00 | 43.02 | 31.02 | 8.99 | 25.57 | 46.56 | 54.00 | -7.44 | AV |
| H | 4882.00 | 51.80 | 30.55 | 5.77 | 24.66 | 51.68 | 74.00 | -22.32 | Pk |
| H | 4882.00 | 43.50 | 30.55 | 5.77 | 24.66 | 43.38 | 54.00 | -10.62 | AV |
| H | 7323.00 | 53.27 | 30.33 | 6.32 | 24.55 | 53.81 | 74.00 | -20.19 | Pk |
| H | 7323.00 | 43.84 | 30.33 | 6.32 | 24.55 | 44.38 | 54.00 | -9.62 | AV |
| H | 9764.00 | 50.24 | 30.85 | 7.45 | 24.69 | 51.53 | 74.00 | -22.47 | Pk |
| H | 9764.00 | 43.23 | 30.85 | 7.45 | 24.69 | 44.52 | 54.00 | -9.48 | AV |
| H | 12205.00 | 54.85 | 31.02 | 8.99 | 25.57 | 58.39 | 74.00 | -15.61 | Pk |
| H | 12205.00 | 43.15 | 31.02 | 8.99 | 25.57 | 46.69 | 54.00 | -7.31 | AV |

| Polar (H/V) | Frequency | Meter Reading | Pre-ampli fier | Cable Loss | Antenna Factor | Emission Level | Limits | Margin | Detector Type |
|----------------------|-----------|------------------|-------------------|---------------|-------------------|-------------------|----------|--------|------------------|
| | (MHz) | (dBuV) | (dB) | (dB) | (dB) | (dBuV/m) | (dBuV/m) | (dB) | |
| High Channel:2480MHz | | | | | | | | | |
| V | 4960.00 | 52.21 | 30.55 | 5.77 | 24.66 | 52.09 | 74.00 | -21.91 | Pk |
| V | 4960.00 | 43.52 | 30.55 | 5.77 | 24.66 | 43.40 | 54.00 | -10.60 | AV |
| V | 7440.00 | 53.18 | 30.33 | 6.32 | 24.55 | 53.72 | 74.00 | -20.28 | Pk |
| V | 7440.00 | 43.43 | 30.33 | 6.32 | 24.55 | 43.97 | 54.00 | -10.03 | AV |
| V | 9920.00 | 51.22 | 30.85 | 7.45 | 24.69 | 52.51 | 74.00 | -21.49 | Pk |
| V | 9920.00 | 43.44 | 30.85 | 7.45 | 24.69 | 44.73 | 54.00 | -9.27 | AV |
| V | 12400.00 | 54.31 | 31.02 | 8.99 | 25.57 | 57.85 | 74.00 | -16.15 | Pk |
| V | 12400.00 | 43.97 | 31.02 | 8.99 | 25.57 | 47.51 | 54.00 | -6.49 | AV |
| H | 4960.00 | 54.17 | 30.55 | 5.77 | 24.66 | 54.05 | 74.00 | -19.95 | Pk |
| H | 4960.00 | 43.52 | 30.55 | 5.77 | 24.66 | 43.40 | 54.00 | -10.60 | AV |
| H | 7440.00 | 52.84 | 30.33 | 6.32 | 24.55 | 53.38 | 74.00 | -20.62 | Pk |
| H | 7440.00 | 43.73 | 30.33 | 6.32 | 24.55 | 44.27 | 54.00 | -9.73 | AV |
| H | 9920.00 | 54.22 | 30.85 | 7.45 | 24.69 | 55.51 | 74.00 | -18.49 | Pk |
| H | 9920.00 | 43.81 | 30.85 | 7.45 | 24.69 | 45.10 | 54.00 | -8.90 | AV |
| H | 12400.00 | 51.12 | 31.02 | 8.99 | 25.57 | 54.66 | 74.00 | -19.34 | Pk |
| H | 12400.00 | 43.80 | 31.02 | 8.99 | 25.57 | 47.34 | 54.00 | -6.66 | AV |

Remark:

1. Emission Level = Meter Reading + Antenna Factor + Cable Loss – Pre-amplifier,
Margin= Emission Level - Limit
2. If peak below the average limit, the average emission was no test.
3. The amplitude of spurious emissions which are attenuated by more than 20dB below the permissible value has no need to be reported.

8-DPSK

| Polar (H/V) | Frequency | Meter Reading | Pre-amplifier | Cable Loss | Antenna Factor | Emission Level | Limits | Margin | Detector Type |
|---------------------|-----------|---------------|---------------|------------|----------------|----------------|----------|--------|---------------|
| | (MHz) | (dBuV) | (dB) | (dB) | (dB) | (dBuV/m) | (dBuV/m) | (dB) | |
| Low Channel:2402MHz | | | | | | | | | |
| V | 4804.00 | 52.96 | 30.55 | 5.77 | 24.66 | 52.84 | 74.00 | -21.16 | Pk |
| V | 4804.00 | 43.29 | 30.55 | 5.77 | 24.66 | 43.17 | 54.00 | -10.83 | AV |
| V | 7206.00 | 54.08 | 30.33 | 6.32 | 24.55 | 54.62 | 74.00 | -19.38 | Pk |
| V | 7206.00 | 43.85 | 30.33 | 6.32 | 24.55 | 44.39 | 54.00 | -9.61 | AV |
| V | 9608.00 | 52.91 | 30.85 | 7.45 | 24.69 | 54.20 | 74.00 | -19.80 | Pk |
| V | 9608.00 | 43.89 | 30.85 | 7.45 | 24.69 | 45.18 | 54.00 | -8.82 | AV |
| V | 12010.00 | 54.71 | 31.02 | 8.99 | 25.57 | 58.25 | 74.00 | -15.75 | Pk |
| V | 12010.00 | 43.45 | 31.02 | 8.99 | 25.57 | 46.99 | 54.00 | -7.01 | AV |
| H | 4804.00 | 53.43 | 30.55 | 5.77 | 24.66 | 53.31 | 74.00 | -20.69 | Pk |
| H | 4804.00 | 43.43 | 30.55 | 5.77 | 24.66 | 43.31 | 54.00 | -10.69 | AV |
| H | 7206.00 | 52.31 | 30.33 | 6.32 | 24.55 | 52.85 | 74.00 | -21.15 | Pk |
| H | 7206.00 | 43.50 | 30.33 | 6.32 | 24.55 | 44.04 | 54.00 | -9.96 | AV |
| H | 9608.00 | 51.07 | 30.85 | 7.45 | 24.69 | 52.36 | 74.00 | -21.64 | Pk |
| H | 9608.00 | 43.60 | 30.85 | 7.45 | 24.69 | 44.89 | 54.00 | -9.11 | AV |
| H | 12010.00 | 53.80 | 31.02 | 8.99 | 25.57 | 57.34 | 74.00 | -16.66 | Pk |
| H | 12010.00 | 43.50 | 31.02 | 8.99 | 25.57 | 47.04 | 54.00 | -6.96 | AV |

| Polar (H/V) | Frequency | Meter Reading | Pre-amplifier | Cable Loss | Antenna Factor | Emission Level | Limits | Margin | Detector Type |
|------------------------|-----------|---------------|---------------|------------|----------------|----------------|----------|--------|---------------|
| | (MHz) | (dBuV) | (dB) | (dB) | (dB) | (dBuV/m) | (dBuV/m) | (dB) | |
| Middle Channel:2441MHz | | | | | | | | | |
| V | 4882.00 | 50.23 | 30.55 | 5.77 | 24.66 | 50.11 | 74.00 | -23.89 | Pk |
| V | 4882.00 | 43.08 | 30.55 | 5.77 | 24.66 | 42.96 | 54.00 | -11.04 | AV |
| V | 7323.00 | 53.09 | 30.33 | 6.32 | 24.55 | 53.63 | 74.00 | -20.37 | Pk |
| V | 7323.00 | 43.93 | 30.33 | 6.32 | 24.55 | 44.47 | 54.00 | -9.53 | AV |
| V | 9764.00 | 50.41 | 30.85 | 7.45 | 24.69 | 51.70 | 74.00 | -22.30 | Pk |
| V | 9764.00 | 43.90 | 30.85 | 7.45 | 24.69 | 45.19 | 54.00 | -8.81 | AV |
| V | 12205.00 | 50.25 | 31.02 | 8.99 | 25.57 | 53.79 | 74.00 | -20.21 | Pk |
| V | 12205.00 | 43.30 | 31.02 | 8.99 | 25.57 | 46.84 | 54.00 | -7.16 | AV |
| H | 4882.00 | 50.81 | 30.55 | 5.77 | 24.66 | 50.69 | 74.00 | -23.31 | Pk |
| H | 4882.00 | 43.39 | 30.55 | 5.77 | 24.66 | 43.27 | 54.00 | -10.73 | AV |
| H | 7323.00 | 54.76 | 30.33 | 6.32 | 24.55 | 55.30 | 74.00 | -18.70 | Pk |
| H | 7323.00 | 43.00 | 30.33 | 6.32 | 24.55 | 43.54 | 54.00 | -10.46 | AV |
| H | 9764.00 | 52.06 | 30.85 | 7.45 | 24.69 | 53.35 | 74.00 | -20.65 | Pk |
| H | 9764.00 | 43.23 | 30.85 | 7.45 | 24.69 | 44.52 | 54.00 | -9.48 | AV |
| H | 12205.00 | 53.80 | 31.02 | 8.99 | 25.57 | 57.34 | 74.00 | -16.66 | Pk |
| H | 12205.00 | 43.64 | 31.02 | 8.99 | 25.57 | 47.18 | 54.00 | -6.82 | AV |

| Polar (H/V) | Frequency | Meter Reading | Pre-ampli fier | Cable Loss | Antenna Factor | Emission Level | Limits | Margin | Detector Type |
|----------------------|-----------|------------------|-------------------|---------------|-------------------|-------------------|----------|--------|------------------|
| | (MHz) | (dBuV) | (dB) | (dB) | (dB) | (dBuV/m) | (dBuV/m) | (dB) | |
| High Channel:2480MHz | | | | | | | | | |
| V | 4960.00 | 54.59 | 30.55 | 5.77 | 24.66 | 54.47 | 74.00 | -19.53 | Pk |
| V | 4960.00 | 43.51 | 30.55 | 5.77 | 24.66 | 43.39 | 54.00 | -10.61 | AV |
| V | 7440.00 | 53.95 | 30.33 | 6.32 | 24.55 | 54.49 | 74.00 | -19.51 | Pk |
| V | 7440.00 | 43.11 | 30.33 | 6.32 | 24.55 | 43.65 | 54.00 | -10.35 | AV |
| V | 9920.00 | 50.49 | 30.85 | 7.45 | 24.69 | 51.78 | 74.00 | -22.22 | Pk |
| V | 9920.00 | 43.19 | 30.85 | 7.45 | 24.69 | 44.48 | 54.00 | -9.52 | AV |
| V | 12400.00 | 51.99 | 31.02 | 8.99 | 25.57 | 55.53 | 74.00 | -18.47 | Pk |
| V | 12400.00 | 43.20 | 31.02 | 8.99 | 25.57 | 46.74 | 54.00 | -7.26 | AV |
| H | 4960.00 | 53.32 | 30.55 | 5.77 | 24.66 | 53.20 | 74.00 | -20.80 | Pk |
| H | 4960.00 | 43.68 | 30.55 | 5.77 | 24.66 | 43.56 | 54.00 | -10.44 | AV |
| H | 7440.00 | 54.12 | 30.33 | 6.32 | 24.55 | 54.66 | 74.00 | -19.34 | Pk |
| H | 7440.00 | 43.95 | 30.33 | 6.32 | 24.55 | 44.49 | 54.00 | -9.51 | AV |
| H | 9920.00 | 52.70 | 30.85 | 7.45 | 24.69 | 53.99 | 74.00 | -20.01 | Pk |
| H | 9920.00 | 43.20 | 30.85 | 7.45 | 24.69 | 44.49 | 54.00 | -9.51 | AV |
| H | 12400.00 | 51.81 | 31.02 | 8.99 | 25.57 | 55.35 | 74.00 | -18.65 | Pk |
| H | 12400.00 | 43.75 | 31.02 | 8.99 | 25.57 | 47.29 | 54.00 | -6.71 | AV |

Remark:

1. Emission Level = Meter Reading + Antenna Factor + Cable Loss – Pre-amplifier,
Margin= Emission Level - Limit
2. If peak below the average limit, the average emission was no test.
3. The amplitude of spurious emissions which are attenuated by more than 20dB below the permissible value has no need to be reported.

5. RADIATED BAND EMISSION MEASUREMENT

5.1 Test Requirement:

| | | | | | |
|-----------------------|--|----------|------|------|---------|
| Test Requirement: | FCC Part15 C Section 15.209 and 15.205 | | | | |
| Test Method: | ANSI C63.10: 2013 | | | | |
| Test Frequency Range: | All of the restrict bands were tested, only the worst band's (2310MHz to 2500MHz) data was showed. | | | | |
| Test site: | Measurement Distance: 3m | | | | |
| Receiver setup: | Frequency | Detector | RBW | VBW | Value |
| | Above 1GHz | Peak | 1MHz | 3MHz | Peak |
| | | Peak | 1MHz | 10Hz | Average |

LIMITS OF RADIATED EMISSION MEASUREMENT (Above 1000MHz)

| FREQUENCY (MHz) | Limit (dBuV/m) (at 3M) | |
|-----------------|------------------------|---------|
| | PEAK | AVERAGE |
| Above 1000 | 74 | 54 |

Notes:

- (1) The limit for radiated test was performed according to FCC PART 15C.
- (2) The tighter limit applies at the band edges.
- (3) Emission level (dBuV/m)=20log Emission level (uV/m).

| Spectrum Parameter | Setting |
|---------------------------------------|--|
| Attenuation | Auto |
| Start Frequency | 2300MHz |
| Stop Frequency | 2520 |
| RB / VB (emission in restricted band) | 1 MHz / 1 MHz for Peak, 1 MHz / 10Hz for Average |

5.2 TEST PROCEDURE

Above 1GHz test procedure as below:

- a. 1. The EUT was placed on the top of a rotating table 1.5 meters above the ground at a 3 meter camber. The table was rotated 360 degrees to determine the position of the highest radiation.
- b. The EUT was set 3 meters away from the interference-receiving antenna, which was mounted on the top of a variable-height antenna tower.
- c. The antenna height is varied from one meter to four meters above the ground to determine the maximum value of the field strength. Both horizontal and vertical polarizations of the antenna are set to make the measurement.
- d. For each suspected emission, the EUT was arranged to its worst case and then the antenna was tuned to heights from 1 meter to 4 meters and the rota table was turned from 0 degrees to 360 degrees to find the maximum reading.
- e. The test-receiver system was set to Peak Detect Function and Specified Bandwidth with Maximum Hold Mode.
- f. If the emission level of the EUT in peak mode was 10dB lower than the limit specified, then testing could be stopped and the peak values of the EUT would be reported. Otherwise the emissions that did not have 10dB margin would be re-tested one by one using peak, quasi-peak or average method as specified and then reported in a data sheet.
- g. Test the EUT in the lowest channel,the Highest channel

Note:

Both horizontal and vertical antenna polarities were tested and performed pretest to three orthogonal axis. The worst case emissions were reported

5.3 DEVIATION FROM TEST STANDARD

No deviation

5.4 TEST SETUP

Radiated Emission Test-Up Frequency Above 1GHz

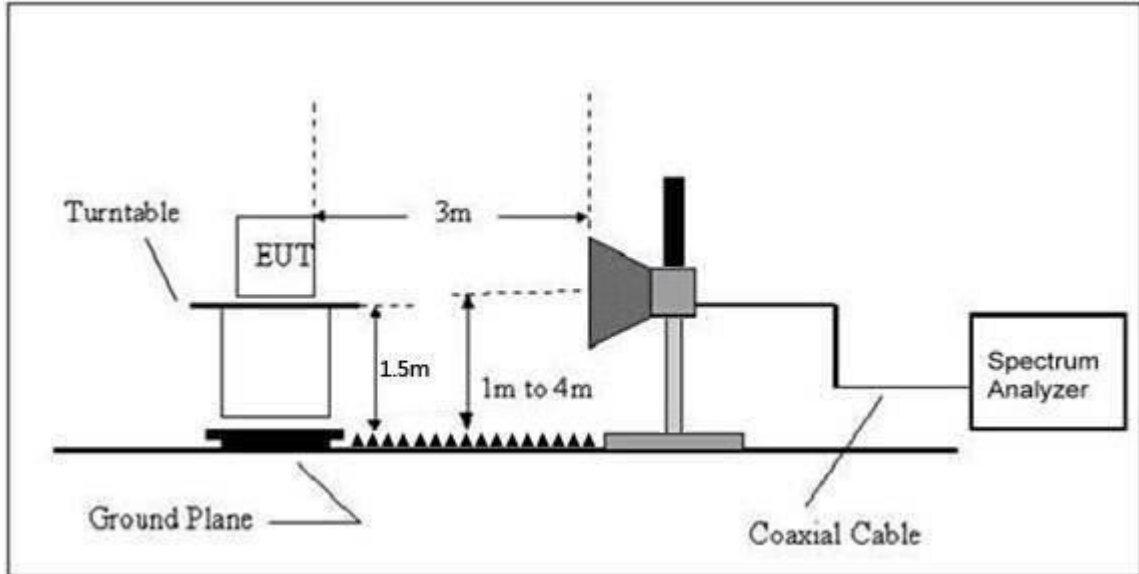

5.5 EUT OPERATING CONDITIONS

The EUT tested system was configured as the statements of 2.3 Unless otherwise a special operating condition is specified in the follows during the testing.

5.6 TEST RESULT

All modes were tested (Worst case GFSK)

| | | | |
|---------------|---------|--------------------|---------------------|
| Temperature: | 26°C | Relative Humidity: | 54% |
| Pressure: | 101kPa | Polarization: | Horizontal |
| Test Voltage: | DC 3.7V | Test channel | 2402MHz(worst case) |

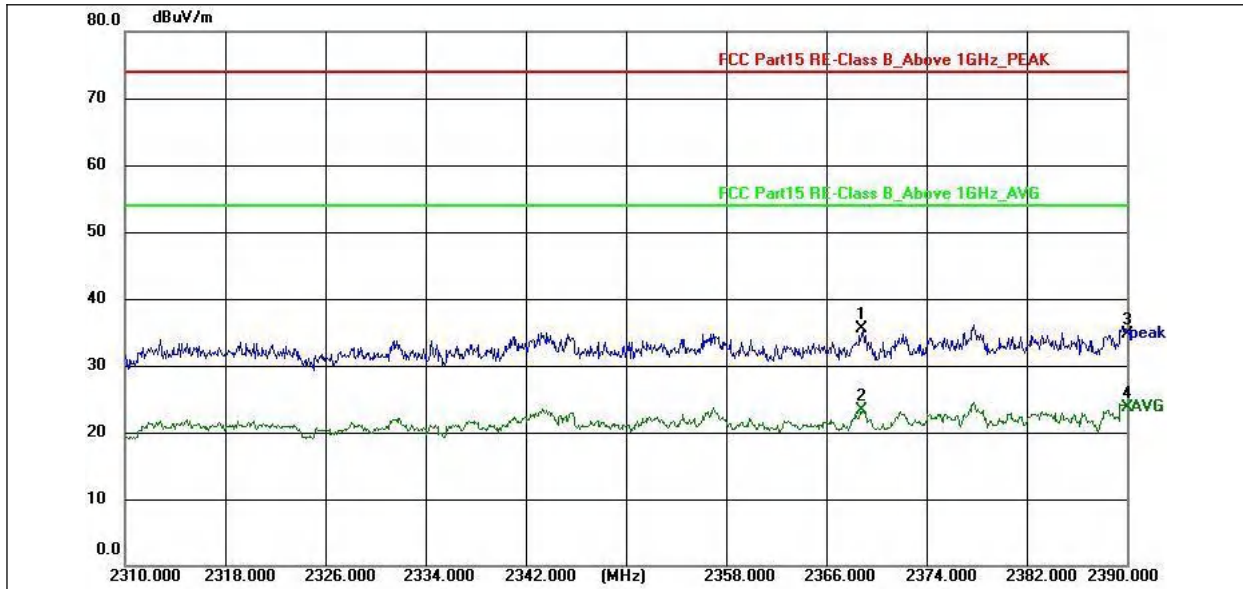

| No. | Frequency (MHz) | Reading (dBuV) | Factor (dB/m) | Level (dBuV/m) | Limit (dBuV/m) | Margin (dB) | Detector |
|-----|-----------------|----------------|---------------|----------------|----------------|-------------|----------|
| 1 | 2368.880 | 39.65 | -4.07 | 35.58 | 74.00 | -38.42 | peak |
| 2 | 2368.880 | 27.36 | -4.07 | 23.29 | 54.00 | -30.71 | AVG |
| 3 | 2390.000 | 38.65 | -3.96 | 34.69 | 74.00 | -39.31 | peak |
| 4 * | 2390.000 | 27.57 | -3.96 | 23.61 | 54.00 | -30.39 | AVG |

| | | | |
|---------------|---------|--------------------|---------------------|
| Temperature: | 26°C | Relative Humidity: | 54% |
| Pressure: | 101kPa | Polarization: | Vertical |
| Test Voltage: | DC 3.7V | Test channel | 2402MHz(worst case) |

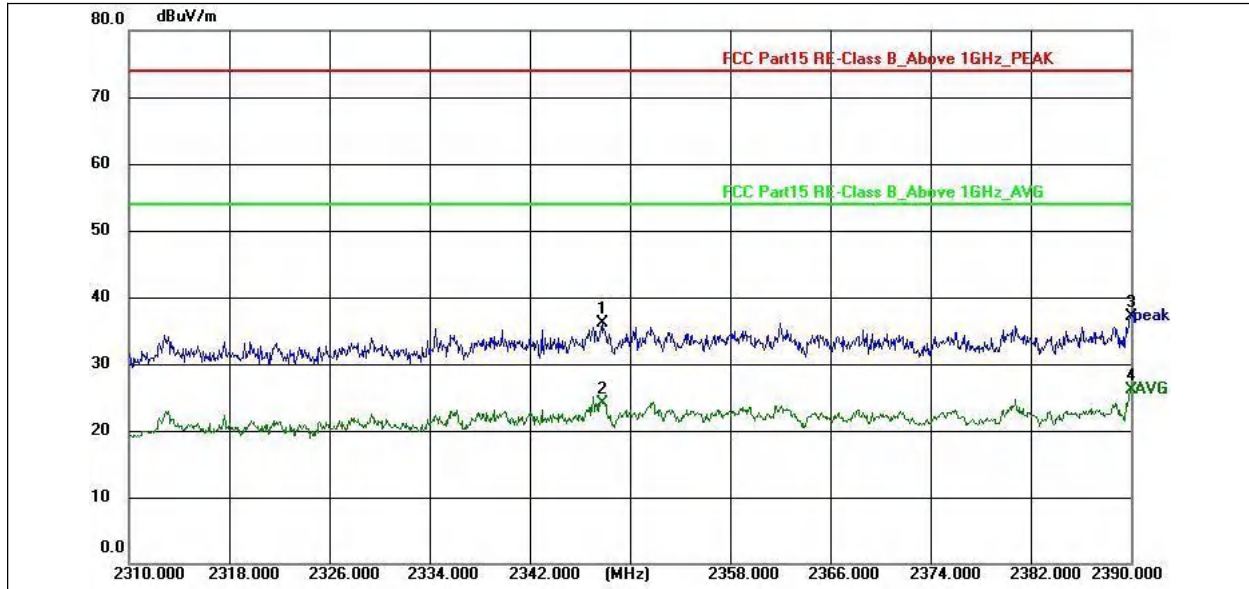

| No. | Frequency (MHz) | Reading (dBuV) | Factor (dB/m) | Level (dBuV/m) | Limit (dBuV/m) | Margin (dB) | Detector |
|-----|-----------------|----------------|---------------|----------------|----------------|-------------|----------|
| 1 | 2347.760 | 40.21 | -4.15 | 36.06 | 74.00 | -37.94 | peak |
| 2 | 2347.760 | 28.34 | -4.15 | 24.19 | 54.00 | -29.81 | AVG |
| 3 | 2390.000 | 41.15 | -3.96 | 37.19 | 74.00 | -36.81 | peak |
| 4 * | 2390.000 | 30.07 | -3.96 | 26.11 | 54.00 | -27.89 | AVG |

| | | | |
|---------------|---------|--------------------|---------------------|
| Temperature: | 26°C | Relative Humidity: | 54% |
| Pressure: | 101kPa | Polarization: | Horizontal |
| Test Voltage: | DC 3.7V | Test channel | 2480MHz(worst case) |

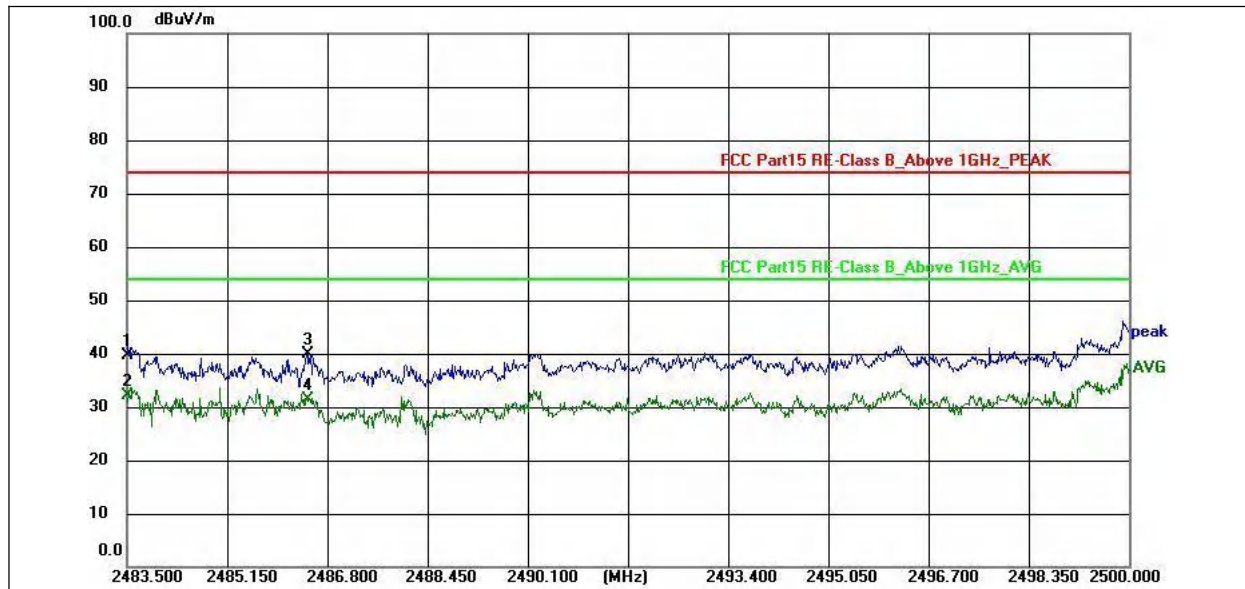

| No. | Frequency (MHz) | Reading (dBuV) | Factor (dB/m) | Level (dBuV/m) | Limit (dBuV/m) | Margin (dB) | Detector |
|-----|-----------------|----------------|---------------|----------------|----------------|-------------|----------|
| 1 | 2483.500 | 43.15 | -3.58 | 39.57 | 74.00 | -34.43 | peak |
| 2 * | 2483.500 | 35.73 | -3.58 | 32.15 | 54.00 | -21.85 | AVG |
| 3 | 2486.484 | 43.45 | -3.57 | 39.88 | 74.00 | -34.12 | peak |
| 4 | 2486.484 | 35.04 | -3.57 | 31.47 | 54.00 | -22.53 | AVG |

| | | | |
|---------------|---------|--------------------|---------------------|
| Temperature: | 26°C | Relative Humidity: | 54% |
| Pressure: | 101kPa | Polarization: | Vertical |
| Test Voltage: | DC 3.7V | Test channel | 2480MHz(worst case) |

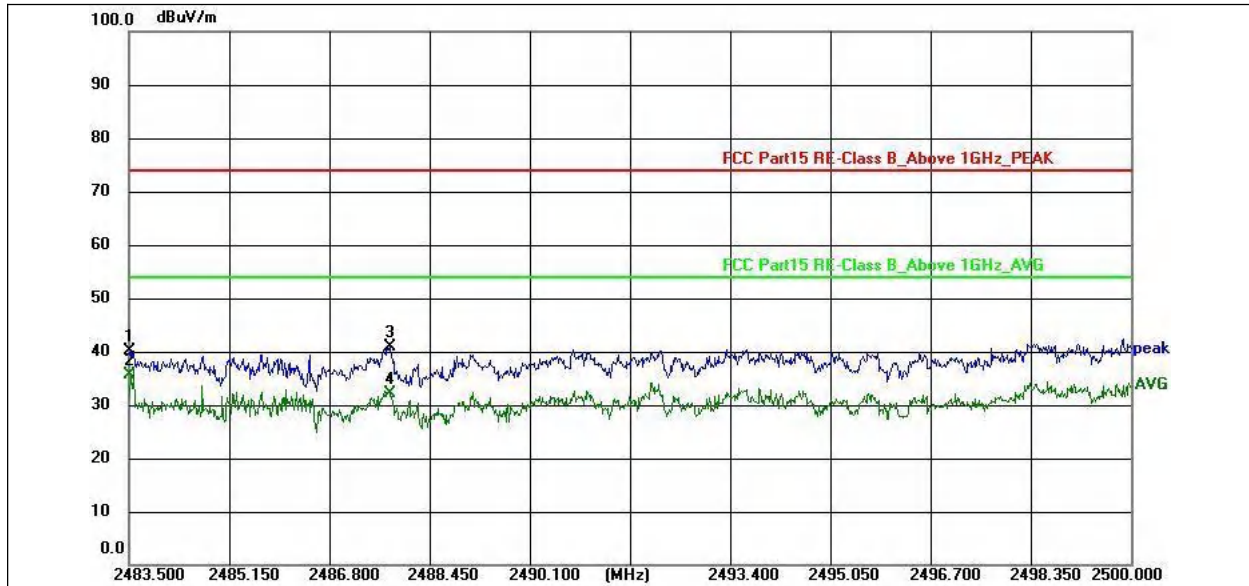

| No. | Frequency (MHz) | Reading (dBuV) | Factor (dB/m) | Level (dBuV/m) | Limit (dBuV/m) | Margin (dB) | Detector |
|-----|-----------------|----------------|---------------|----------------|----------------|-------------|----------|
| 1 | 2483.500 | 43.65 | -3.58 | 40.07 | 74.00 | -33.93 | peak |
| 2 * | 2483.500 | 39.23 | -3.58 | 35.65 | 54.00 | -18.35 | AVG |
| 3 | 2487.812 | 44.46 | -3.56 | 40.90 | 74.00 | -33.10 | peak |
| 4 | 2487.812 | 35.72 | -3.56 | 32.16 | 54.00 | -21.84 | AVG |

6. CONDUCTED BAND EDGE AND SPURIOUS EMISSION

| | |
|-------------------|---|
| Test Requirement: | FCC Part15 C Section 15.247 (d) |
| Test Method: | KDB558074 D0115.247 Meas Guidancev05r02 |

6.1 Limit

Regulation 15.247 (d), In any 100 kHz bandwidth outside the frequency band in which the spread spectrum or digitally modulated intentional radiator is operating, the radio frequency power that is produced by the intentional radiator shall be at least 20 dB below that in the 100 kHz bandwidth within the band that contains the highest level of the desired power, based on either an RF conducted or a radiated measurement, provided the transmitter demonstrates compliance with the peak conducted power limits. If the transmitter complies with the conducted power limits based on the use of RMS averaging over a time interval, as permitted under paragraph (b)(3) of this section, the attenuation required under this paragraph shall be 30 dB instead of 20 dB. Attenuation below the general limits specified in §15.209(a) is not required. In addition, radiated emissions which fall in the restricted bands, as defined in §15.205(a), must also comply with the radiated emission limits specified in §15.209(a) (see §15.205(c)).

6.2 Test Setup



6.3 Test procedure

Using the following spectrum analyzer setting:

- A) Set the RBW = 100KHz.
- B) Set the VBW = 300KHz.
- C) Sweep time = auto couple.
- D) Detector function = peak.
- E) Trace mode = max hold.
- F) Allow trace to fully stabilize.

6.4 DEVIATION FROM STANDARD

No deviation.

6.5 Test Result

GFSK mode:

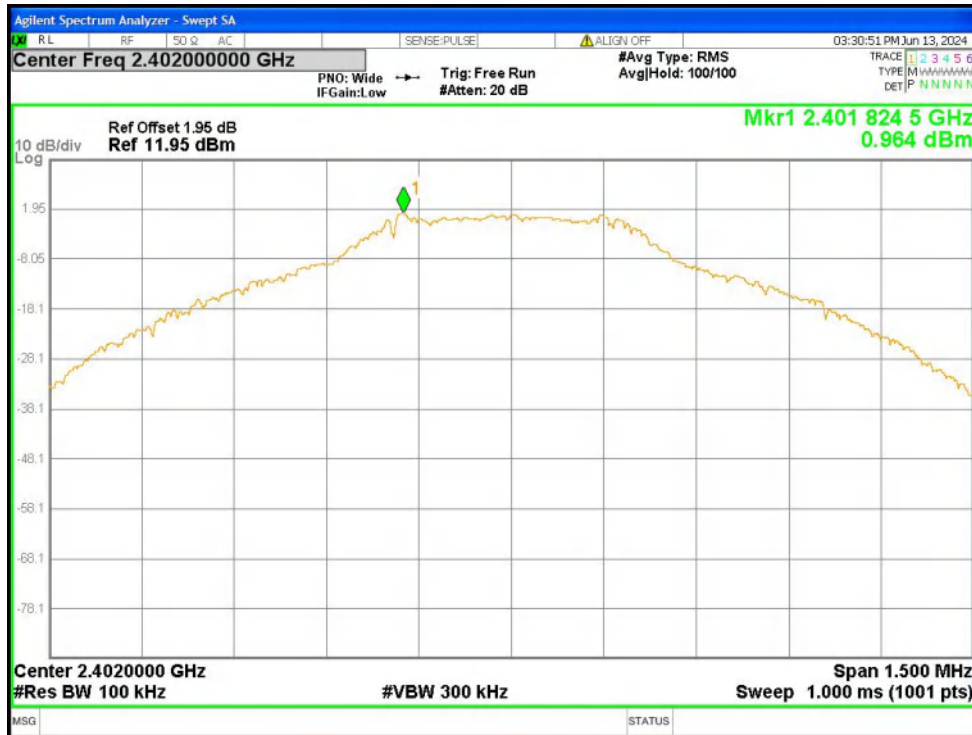

Tx. Spurious NVNT 1-DH5 2402MHz Ant1 Ref

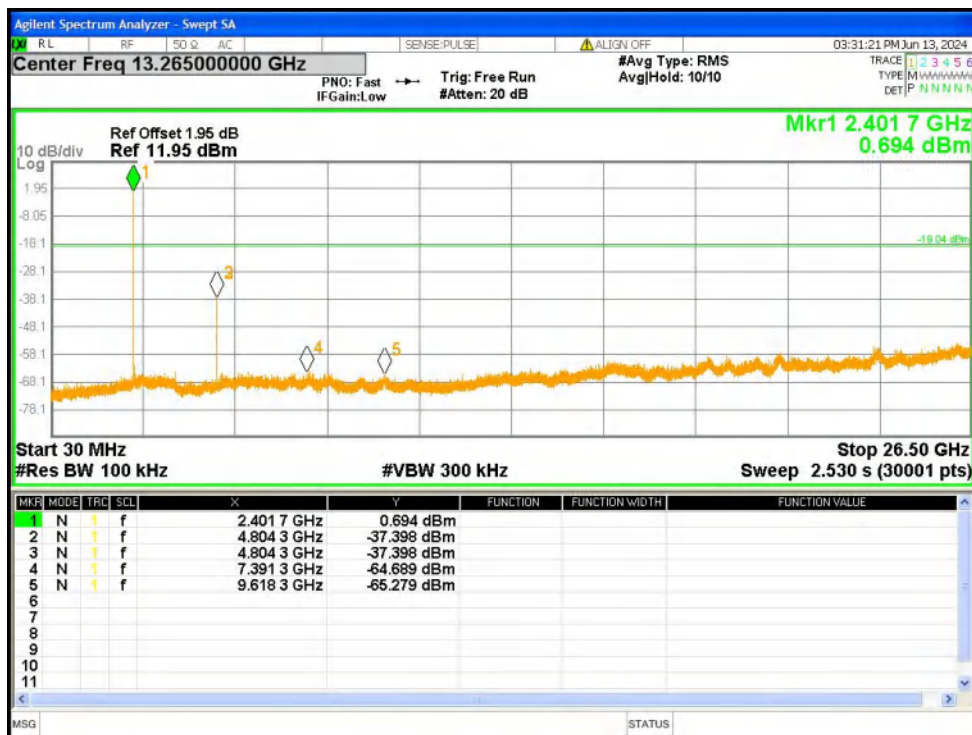

Tx. Spurious NVNT 1-DH5 2402MHz Ant1 Emission



Tx. Spurious NVNT 1-DH5 2441MHz Ant1 Ref

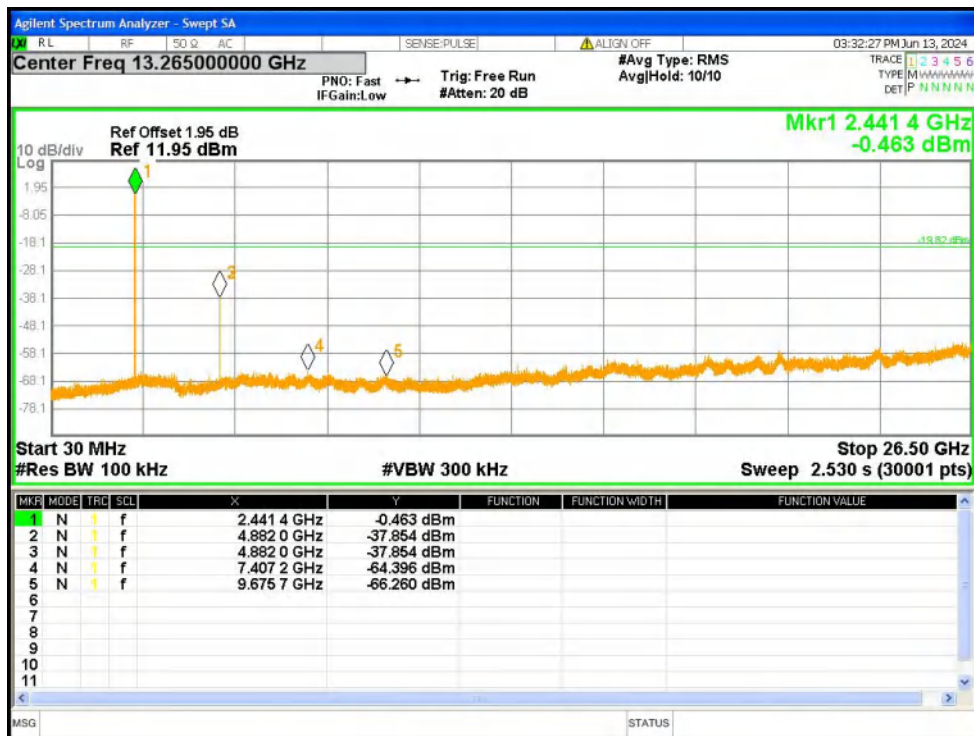

Tx. Spurious NVNT 1-DH5 2441MHz Ant1 Emission

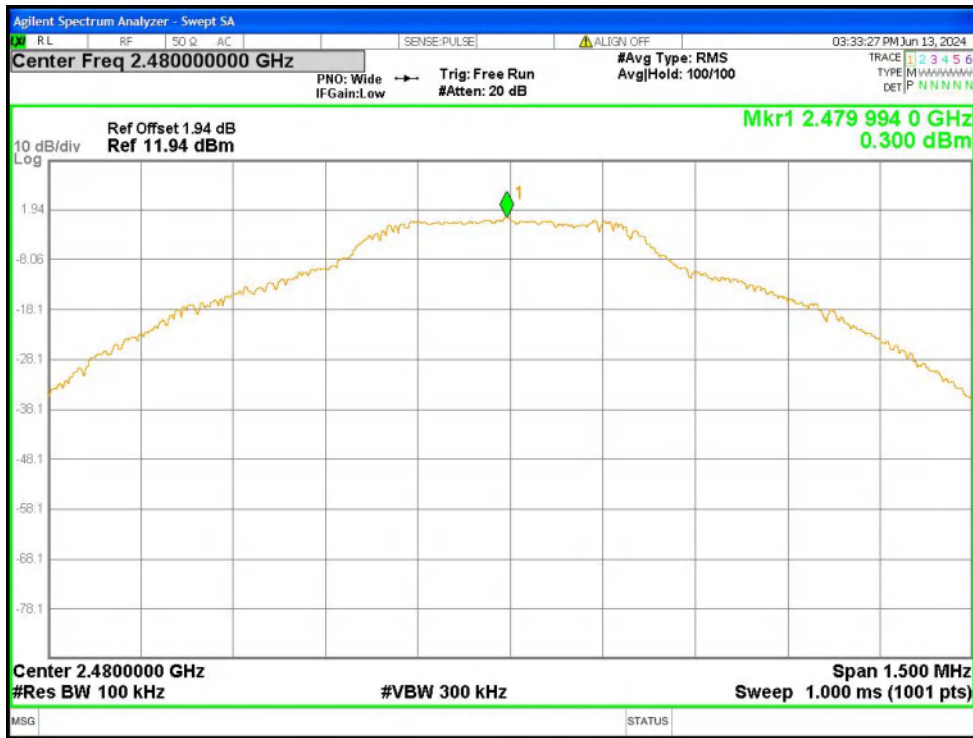

Tx. Spurious NVNT 1-DH5 2480MHz Ant1 Ref

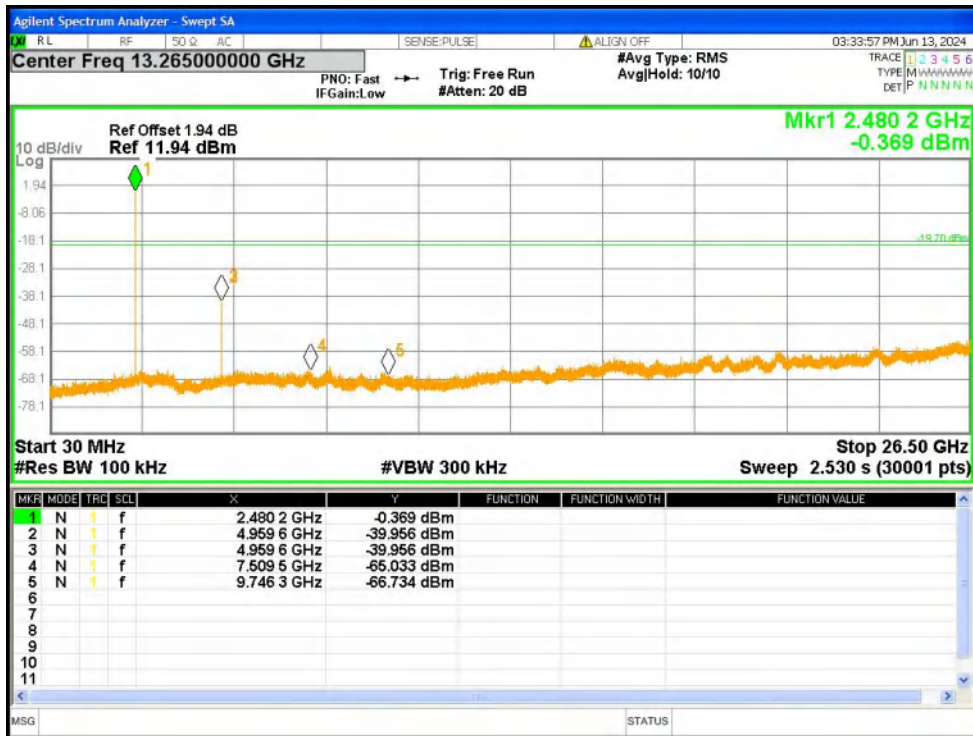

Tx. Spurious NVNT 1-DH5 2480MHz Ant1 Emission

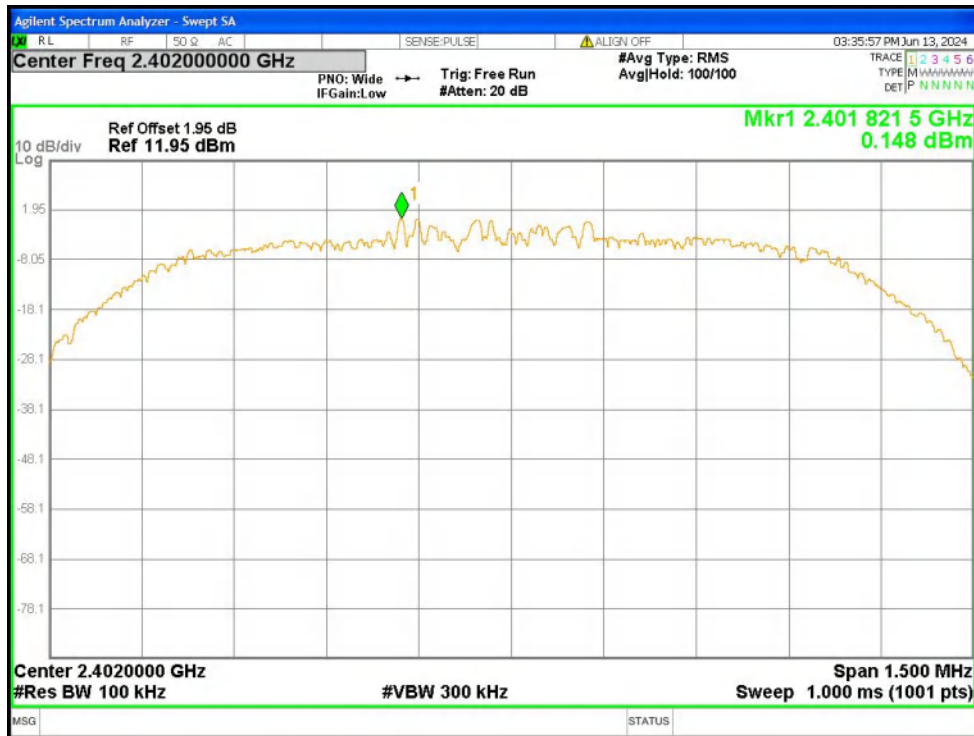

Tx. Spurious NVNT 2-DH5 2402MHz Ant1 Ref

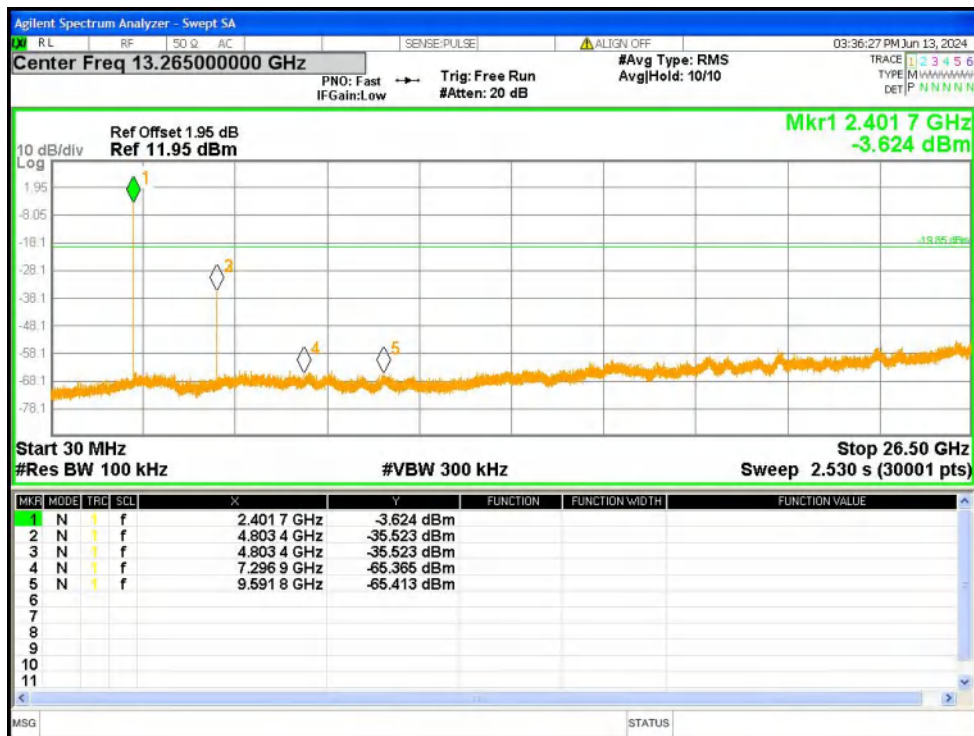

Tx. Spurious NVNT 2-DH5 2402MHz Ant1 Emission

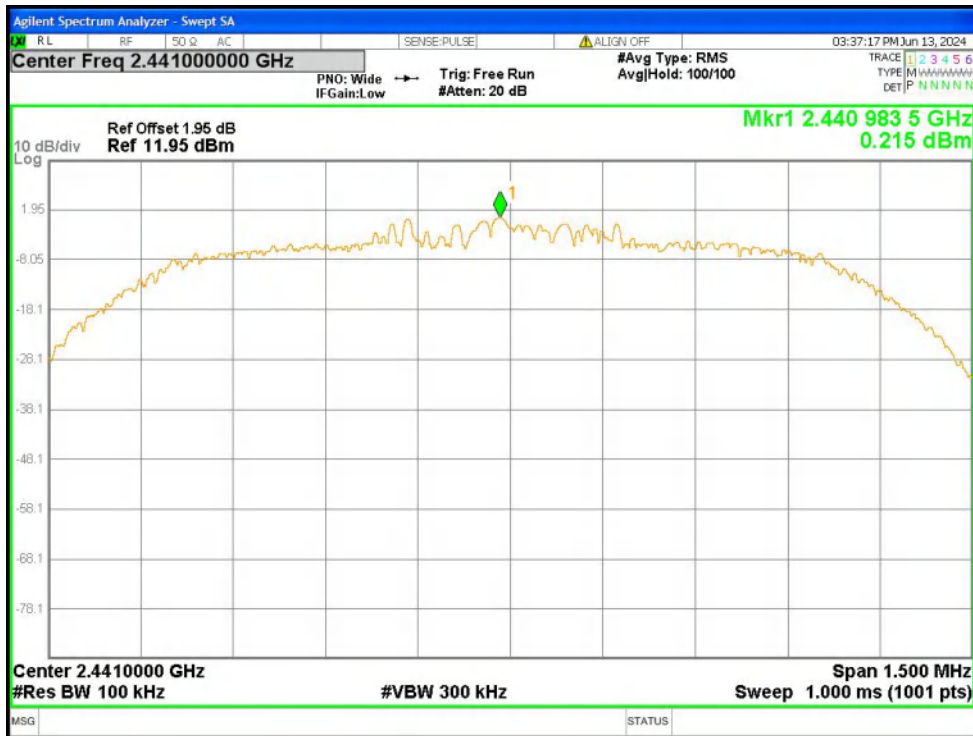

Tx. Spurious NVNT 2-DH5 2441MHz Ant1 Ref

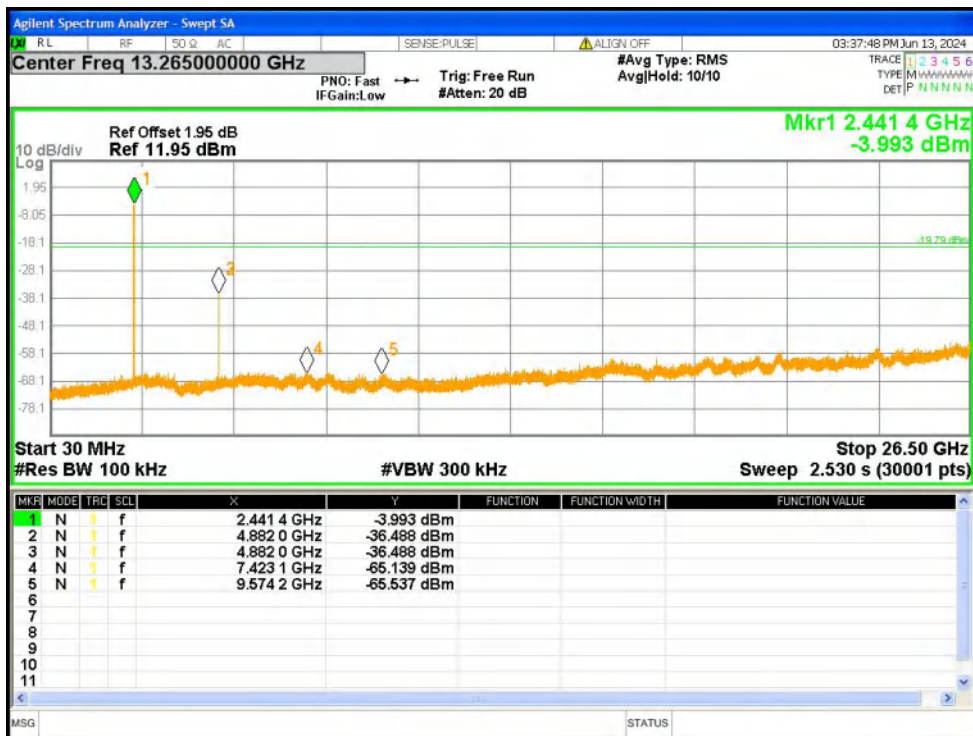

Tx. Spurious NVNT 2-DH5 2441MHz Ant1 Emission

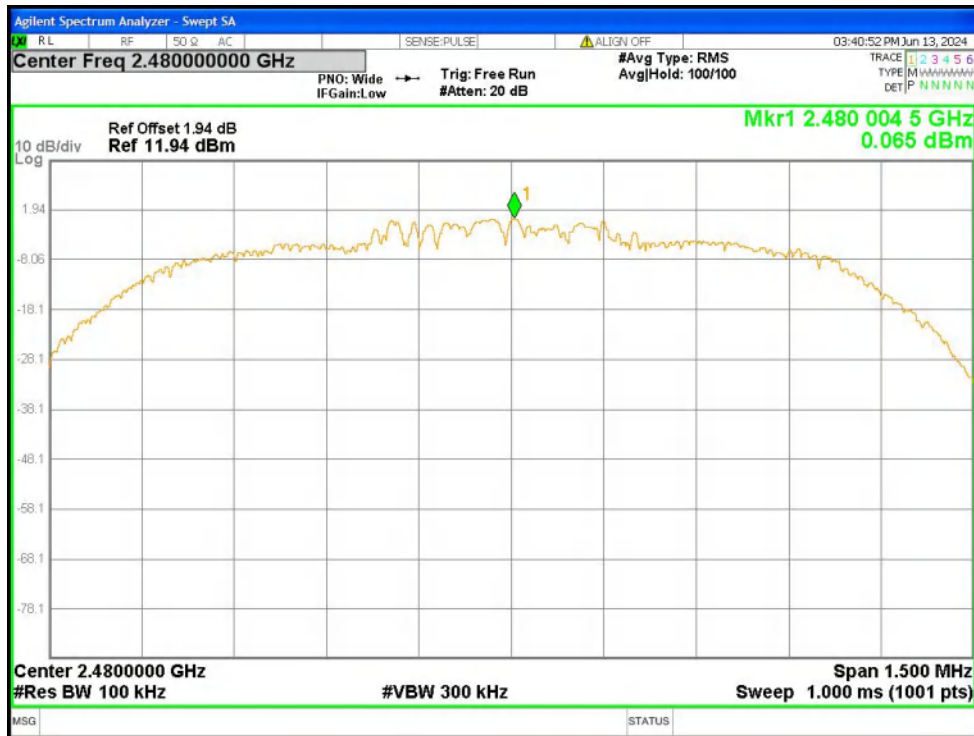

Tx. Spurious NVNT 2-DH5 2480MHz Ant1 Ref

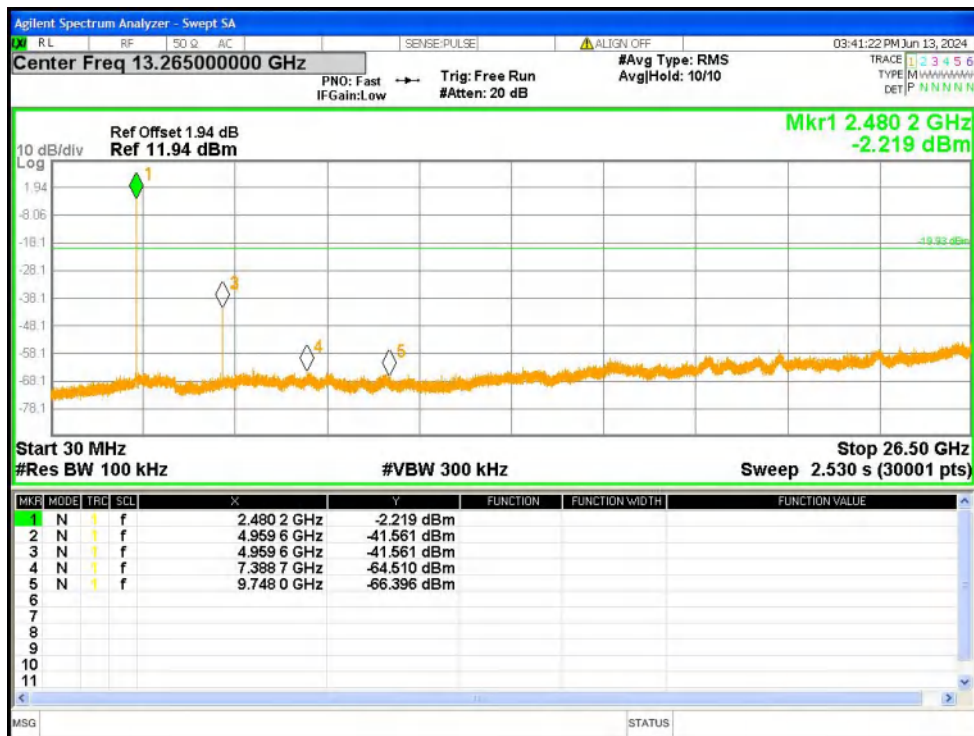

Tx. Spurious NVNT 2-DH5 2480MHz Ant1 Emission

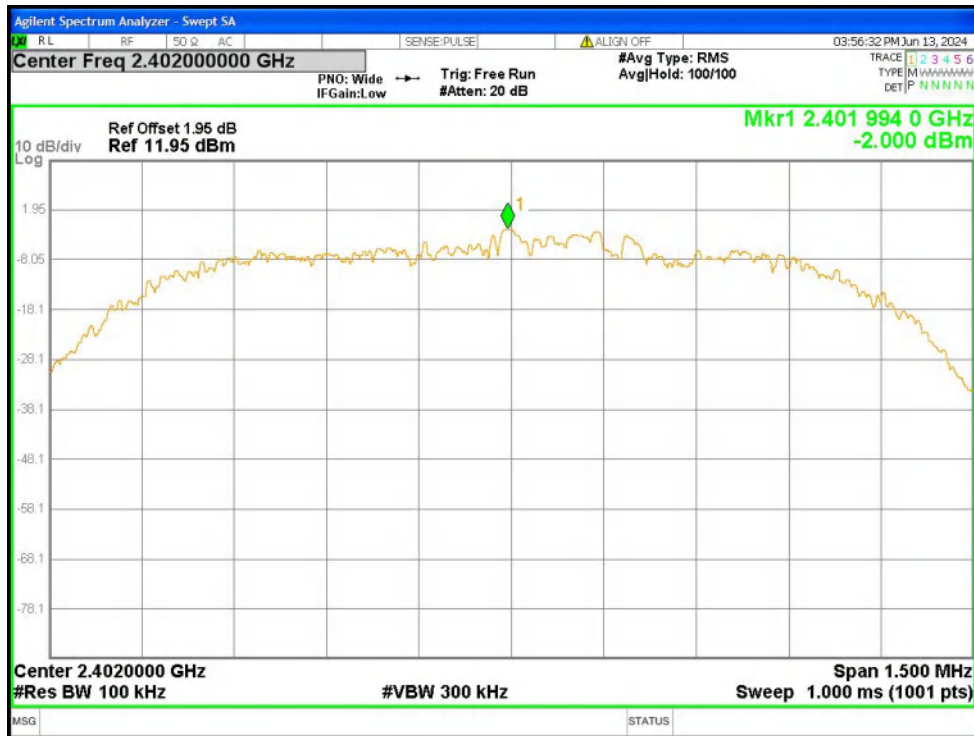

Tx. Spurious NVNT 3-DH5 2402MHz Ant1 Ref

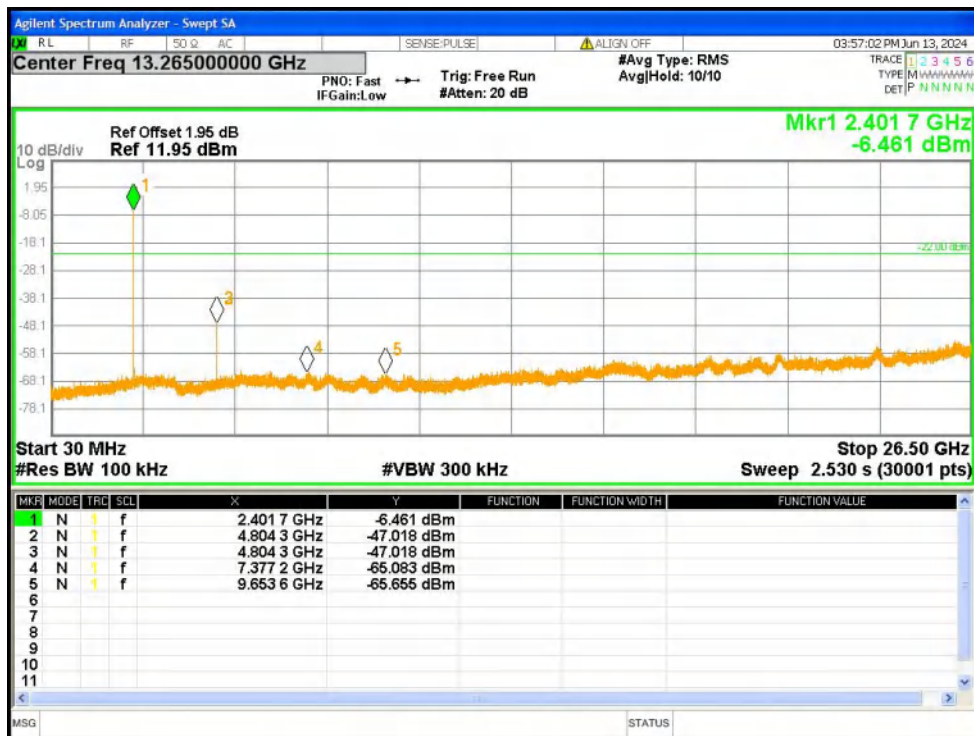

Tx. Spurious NVNT 3-DH5 2402MHz Ant1 Emission

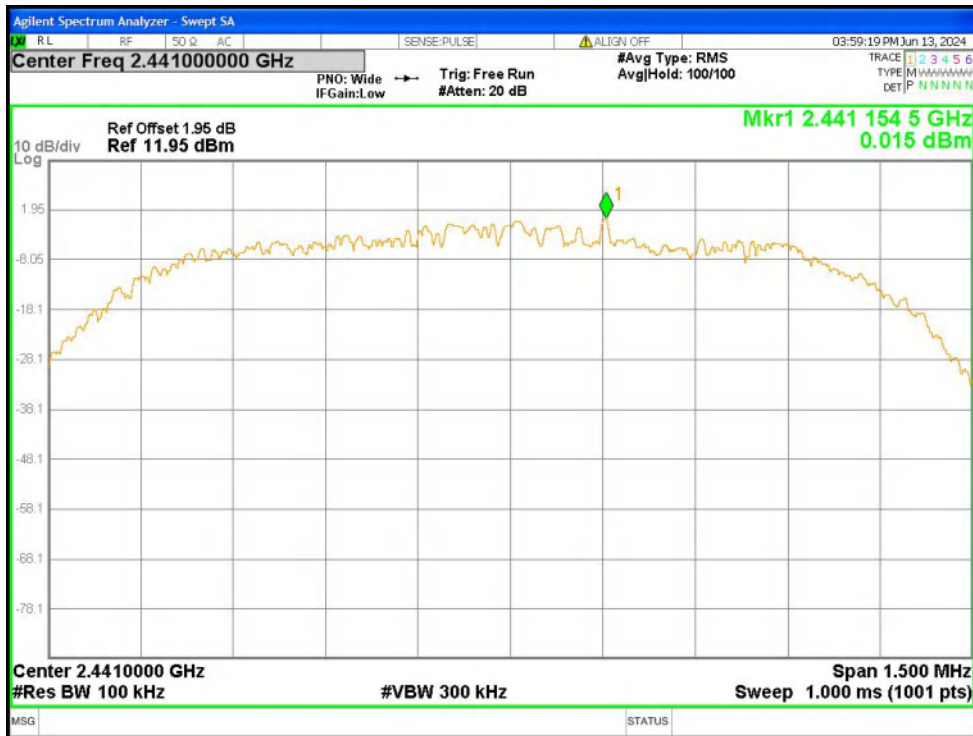

Tx. Spurious NVNT 3-DH5 2441MHz Ant1 Ref

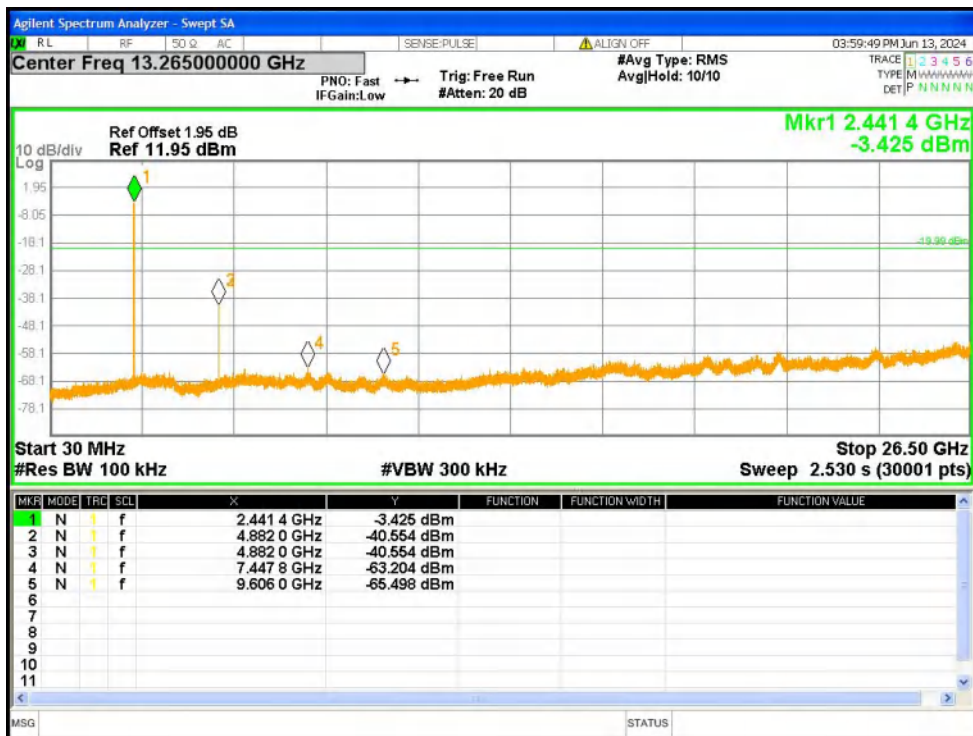

Tx. Spurious NVNT 3-DH5 2441MHz Ant1 Emission

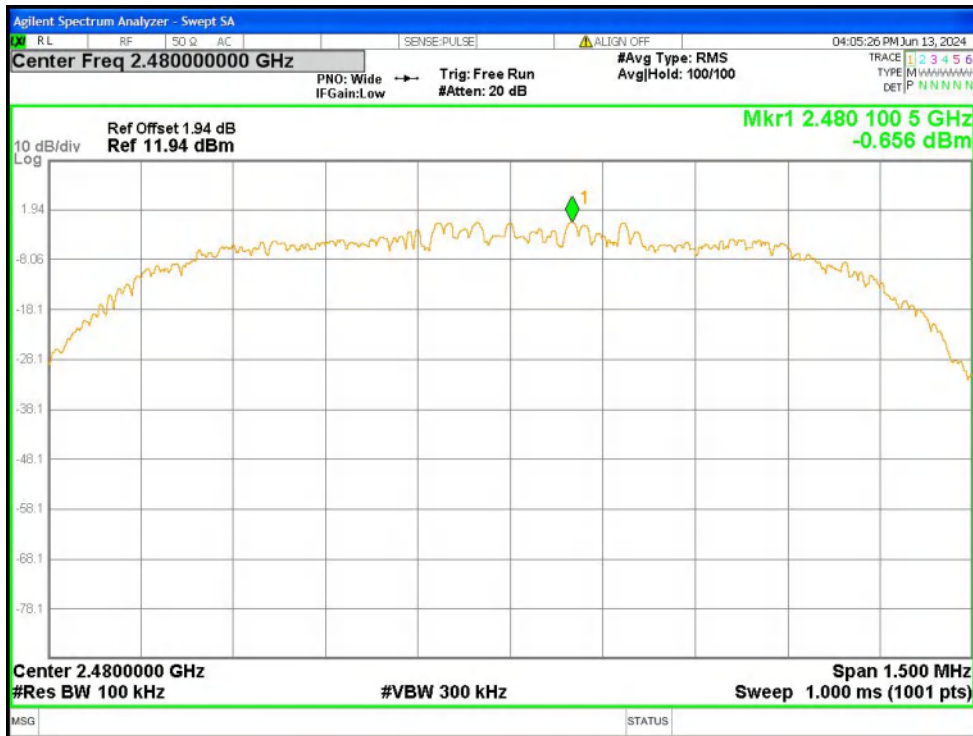

Tx. Spurious NVNT 3-DH5 2480MHz Ant1 Ref

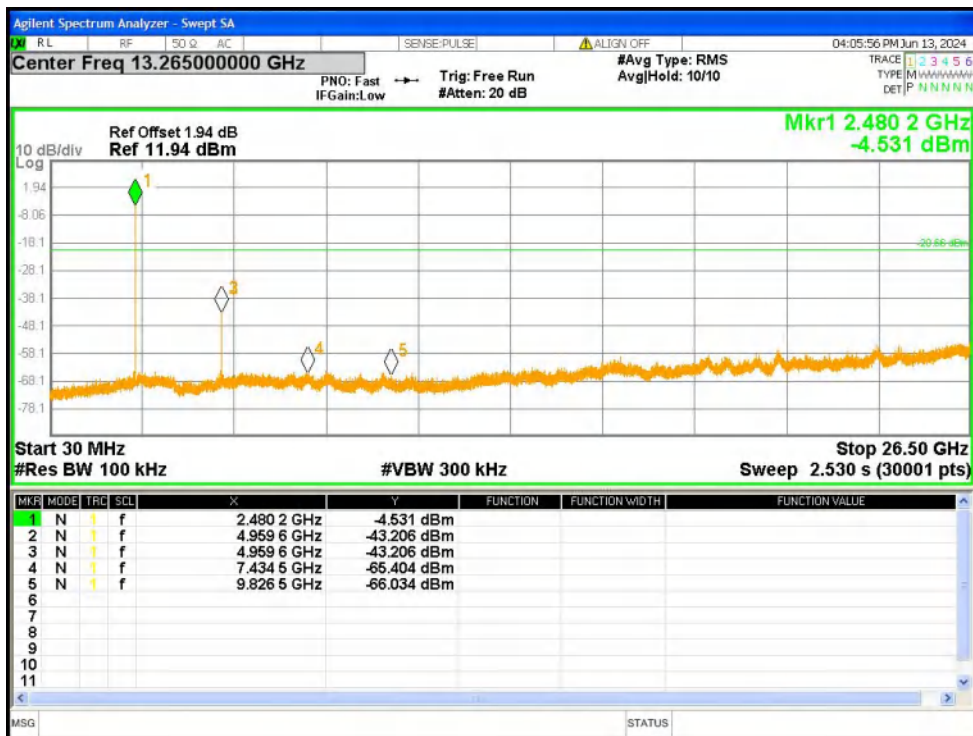

Tx. Spurious NVNT 3-DH5 2480MHz Ant1 Emission



Band Edge NVNT 1-DH5 2480MHz Ant1 No-Hopping Ref

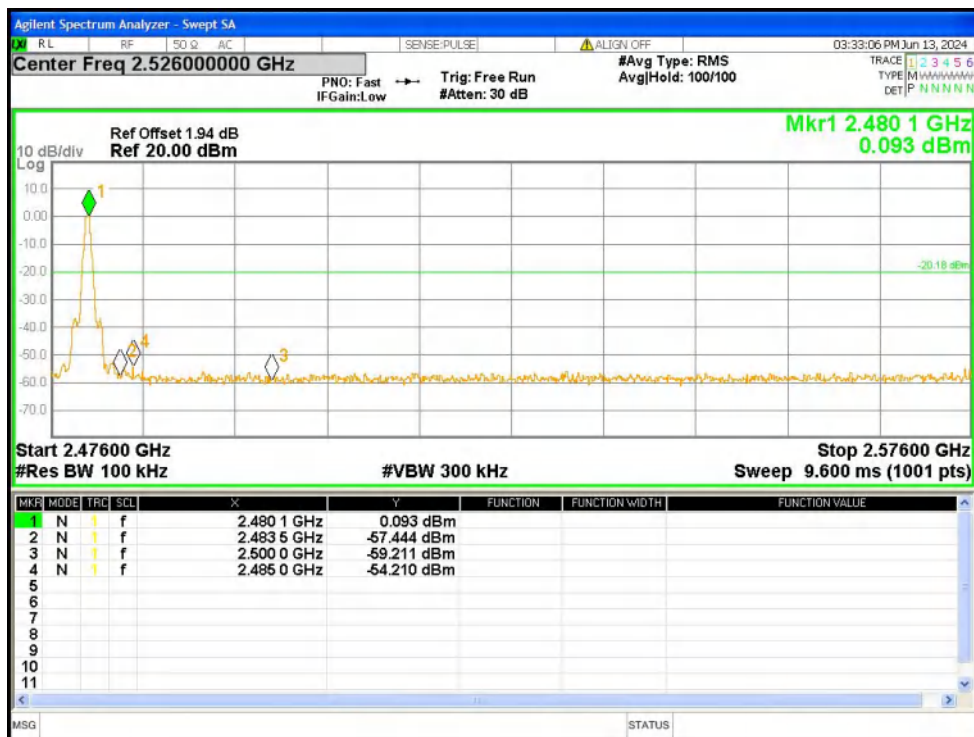

Band Edge NVNT 1-DH5 2480MHz Ant1 No-Hopping Emission

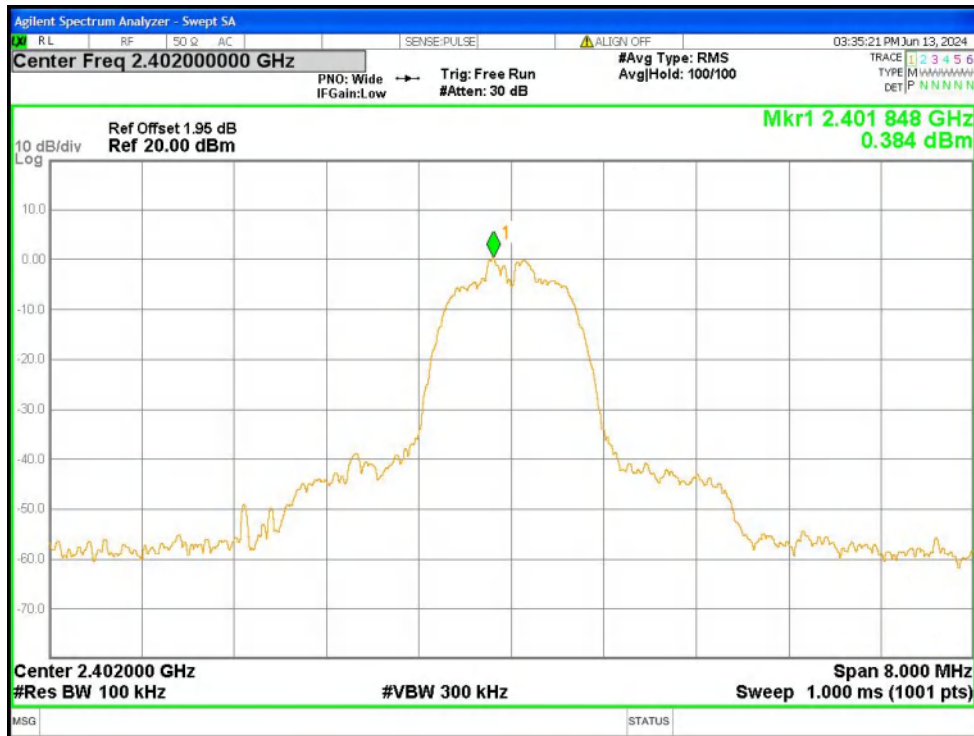

Band Edge NVNT 2-DH5 2402MHz Ant1 No-Hopping Ref

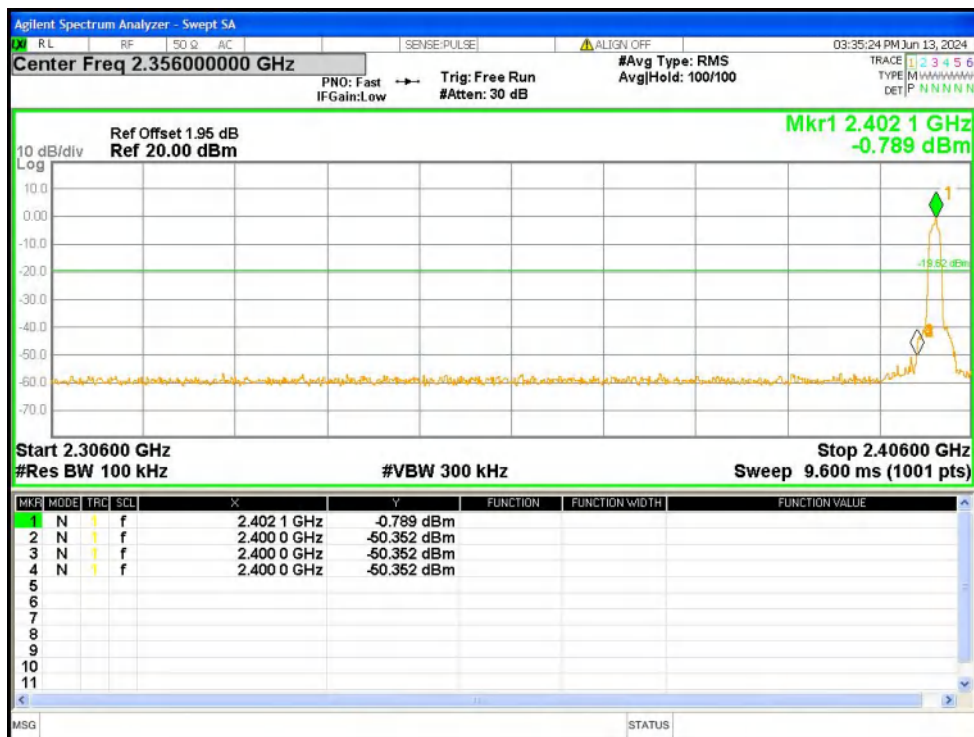

Band Edge NVNT 2-DH5 2402MHz Ant1 No-Hopping Emission

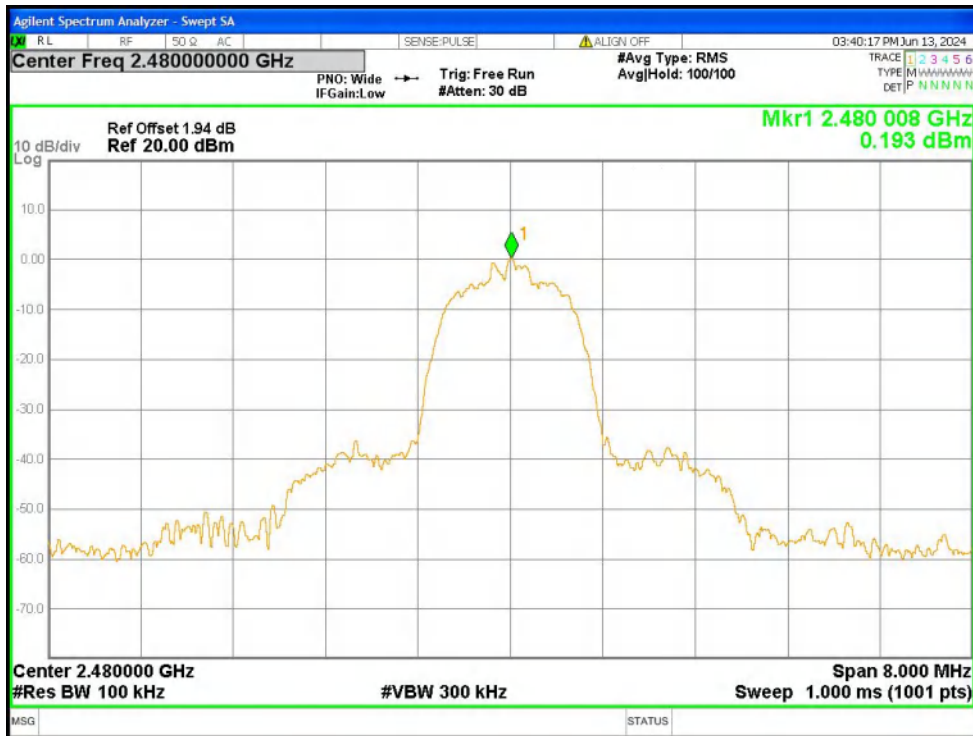

Band Edge NVNT 2-DH5 2480MHz Ant1 No-Hopping Ref

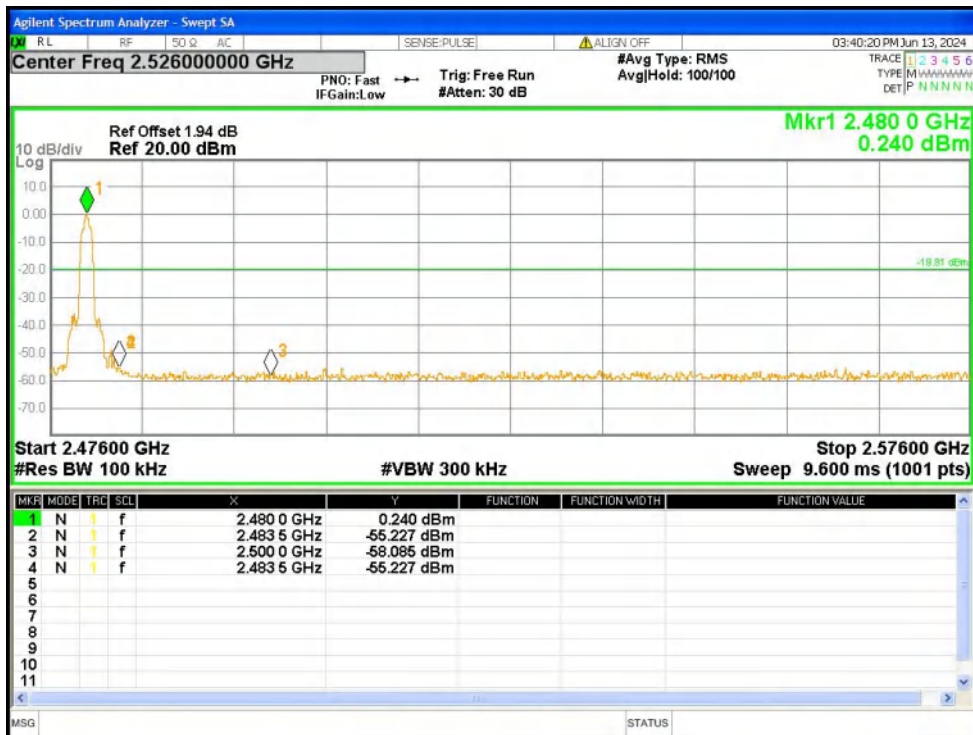

Band Edge NVNT 2-DH5 2480MHz Ant1 No-Hopping Emission

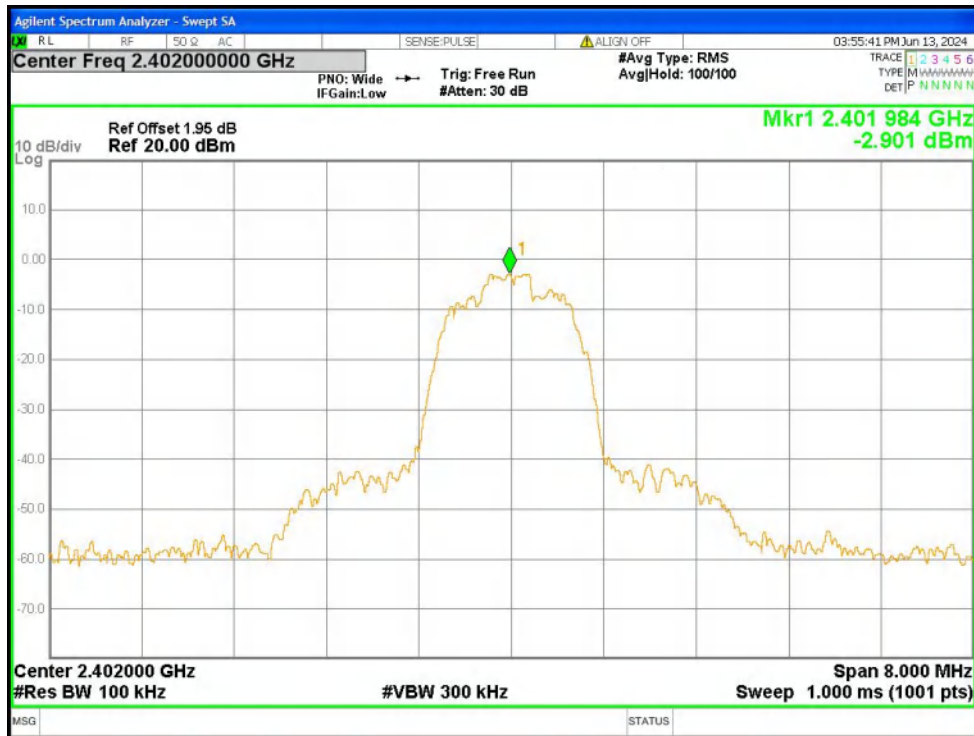

Band Edge NVNT 3-DH5 2402MHz Ant1 No-Hopping Ref

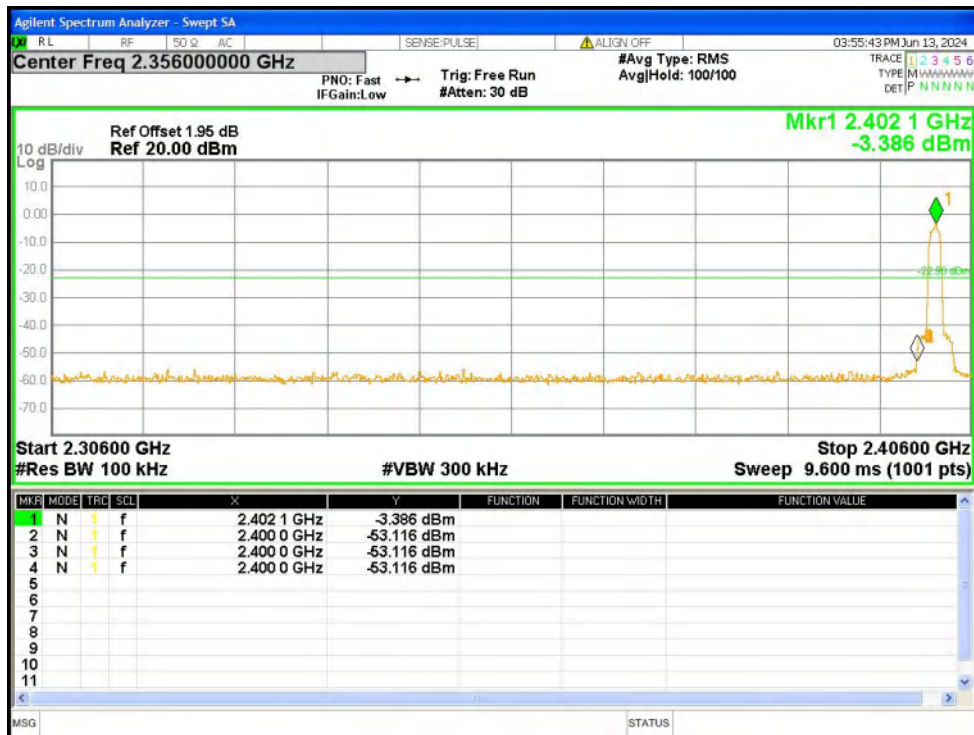

Band Edge NVNT 3-DH5 2402MHz Ant1 No-Hopping Emission

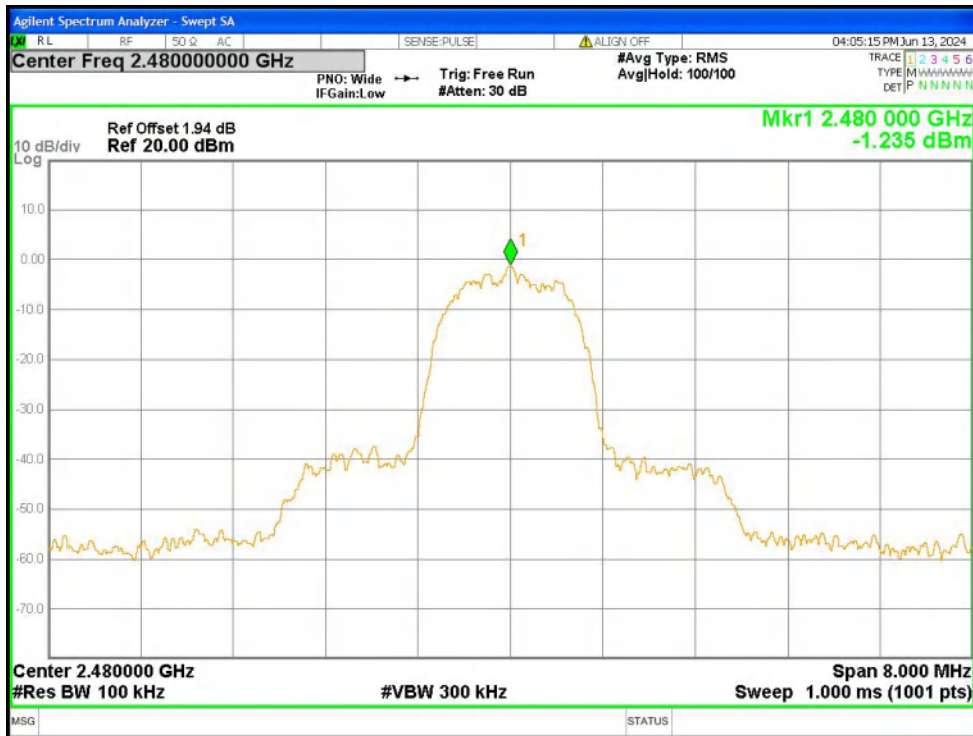

Band Edge NVNT 3-DH5 2480MHz Ant1 No-Hopping Ref

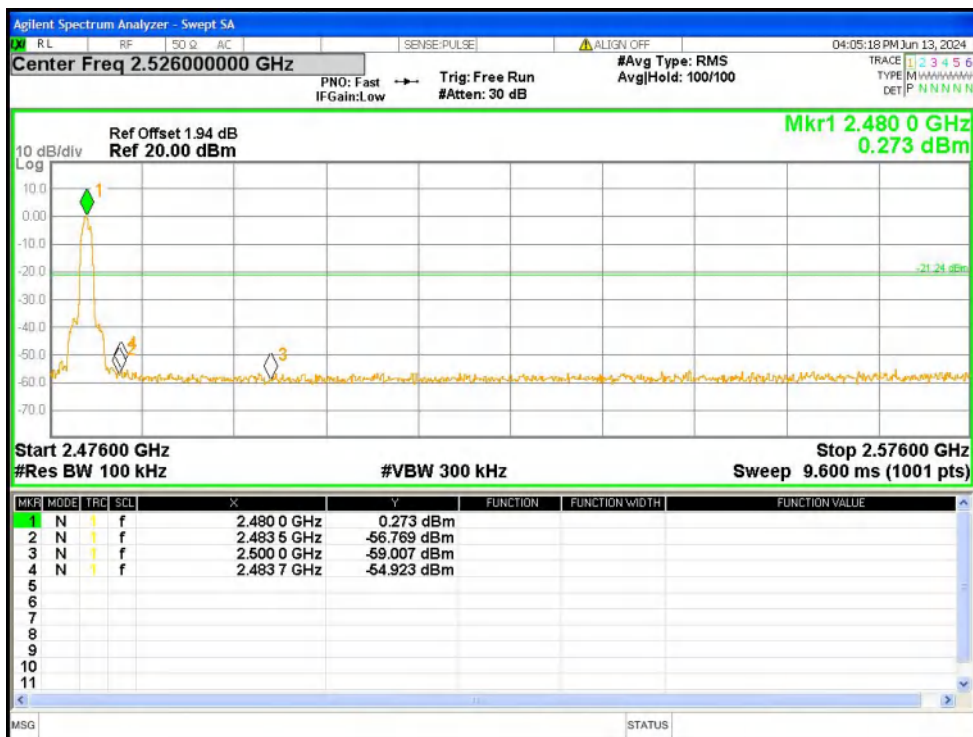

Band Edge NVNT 3-DH5 2480MHz Ant1 No-Hopping Emission



Band Edge(Hopping) NVNT 1-DH5 2402MHz Ant1 Hopping Ref

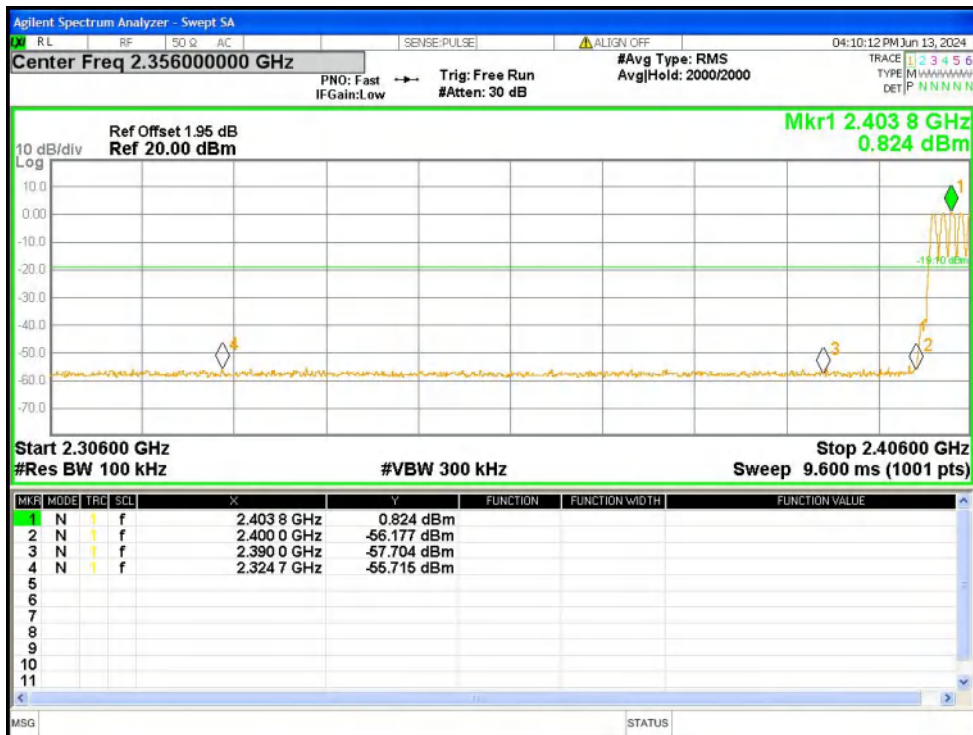

Band Edge(Hopping) NVNT 1-DH5 2402MHz Ant1 Hopping Emission



Band Edge(Hopping) NVNT 1-DH5 2480MHz Ant1 Hopping Ref

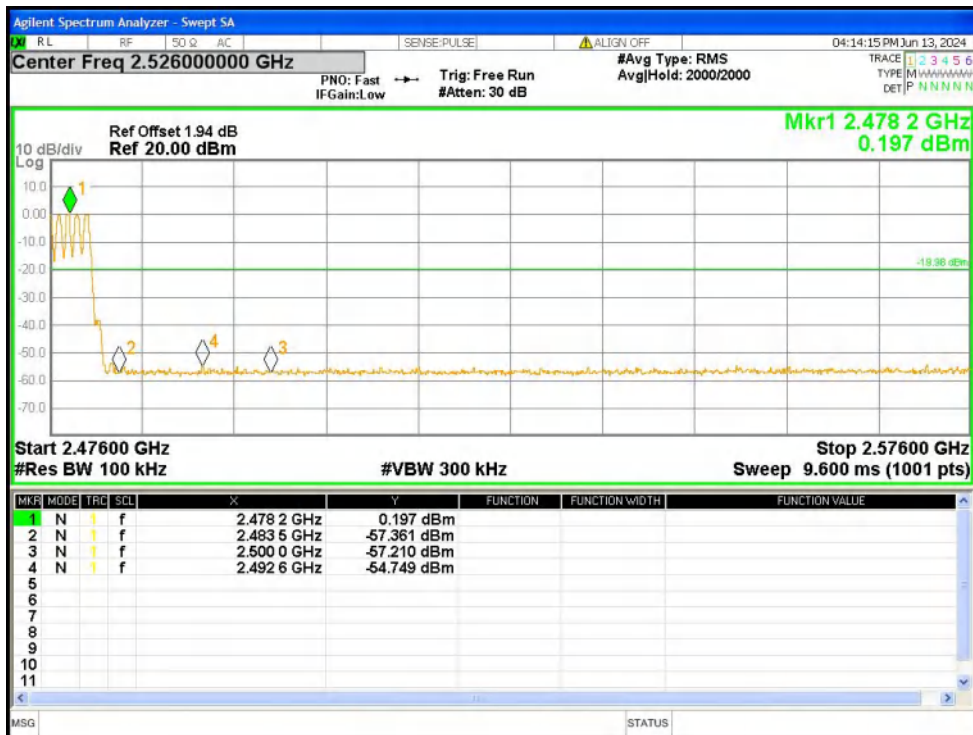

Band Edge(Hopping) NVNT 1-DH5 2480MHz Ant1 Hopping Emission

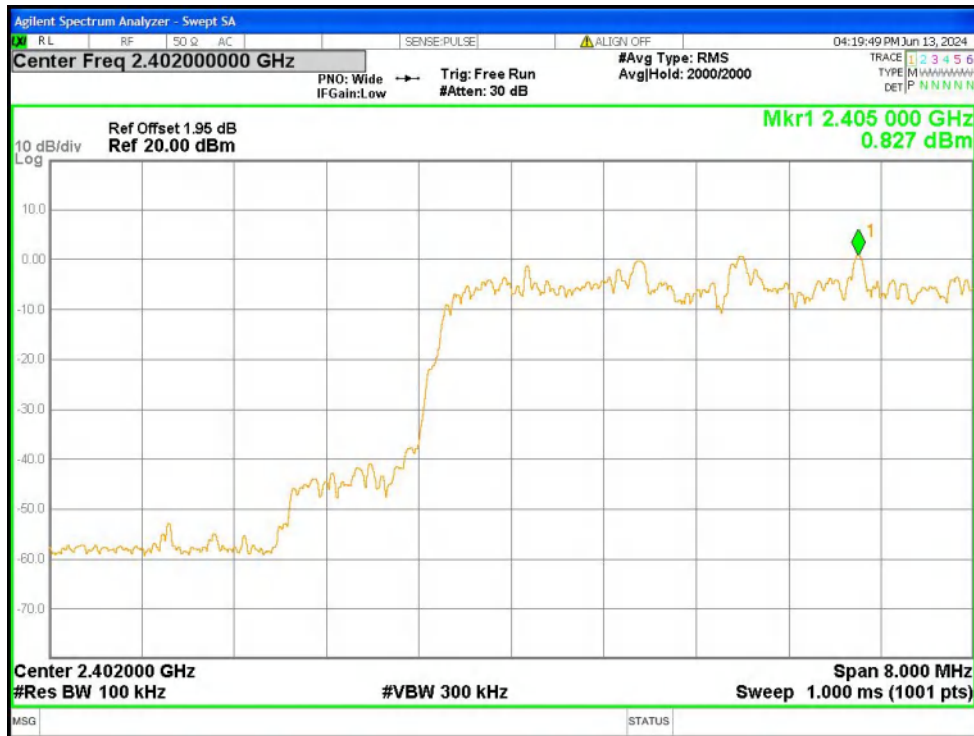

Band Edge(Hopping) NVNT 2-DH5 2402MHz Ant1 Hopping Ref

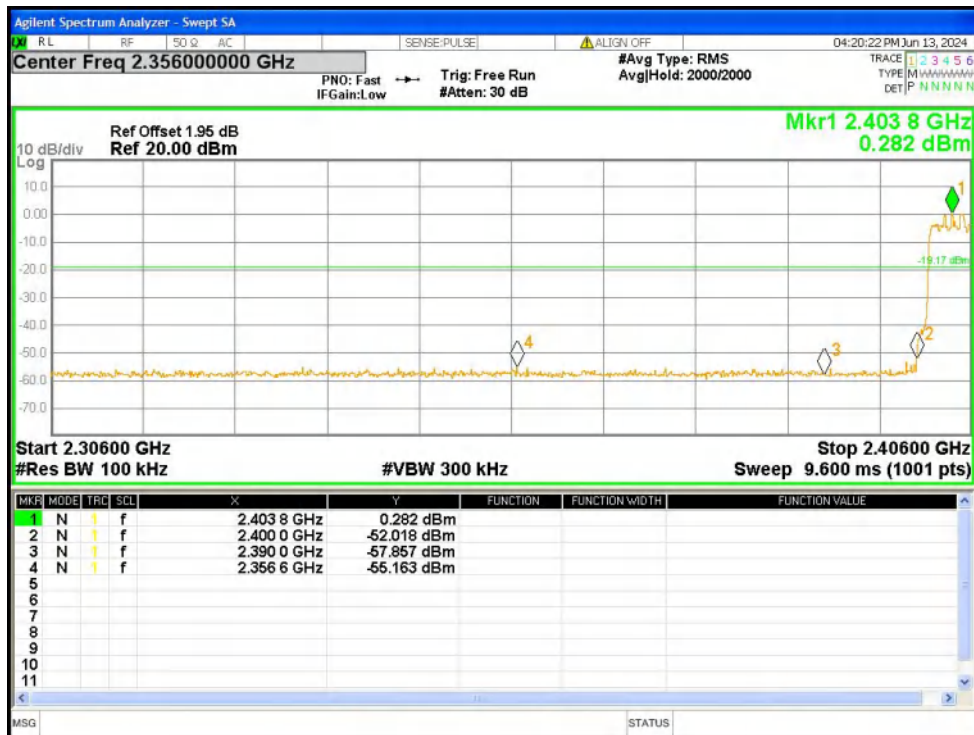

Band Edge(Hopping) NVNT 2-DH5 2402MHz Ant1 Hopping Emission



Band Edge(Hopping) NVNT 2-DH5 2480MHz Ant1 Hopping Ref

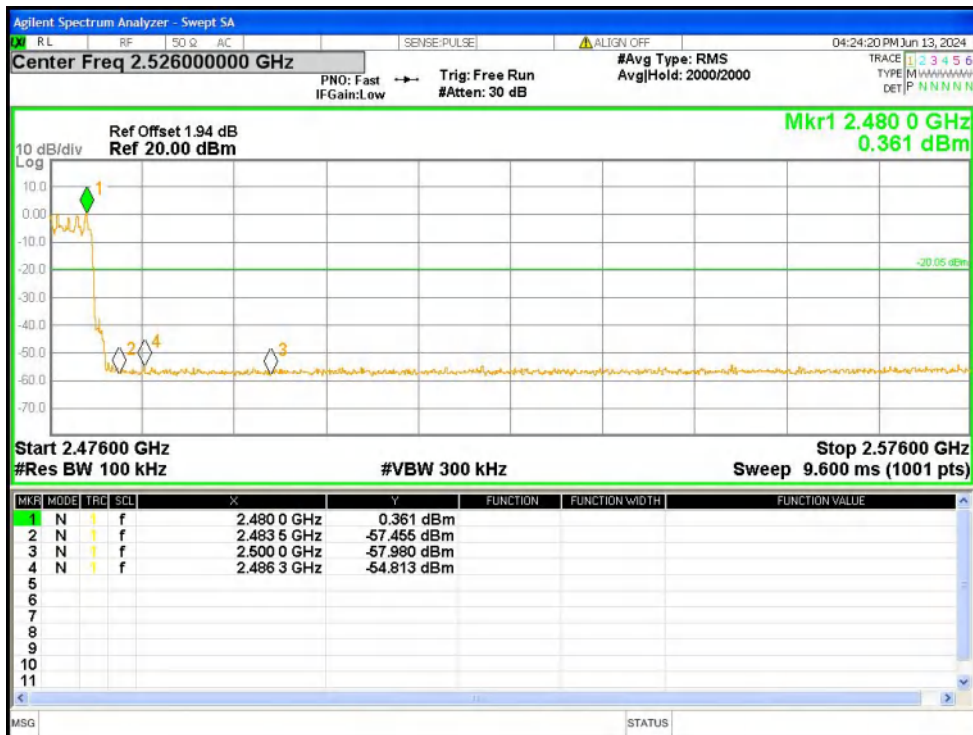

Band Edge(Hopping) NVNT 2-DH5 2480MHz Ant1 Hopping Emission

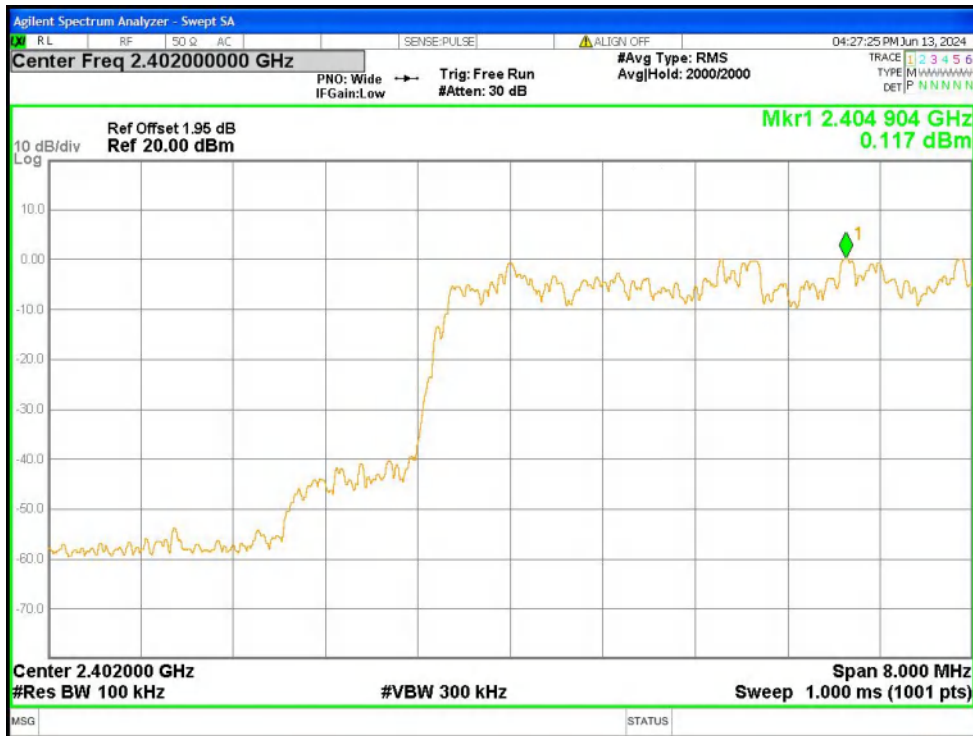

Band Edge(Hopping) NVNT 3-DH5 2402MHz Ant1 Hopping Ref

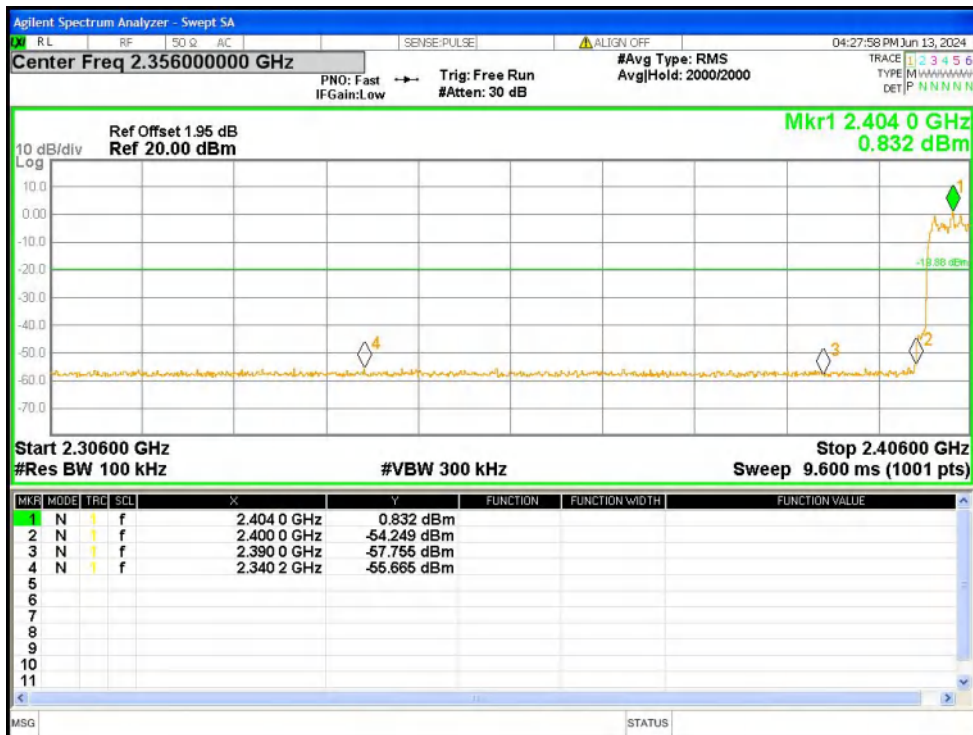

Band Edge(Hopping) NVNT 3-DH5 2402MHz Ant1 Hopping Emission



Band Edge(Hopping) NVNT 3-DH5 2480MHz Ant1 Hopping Ref

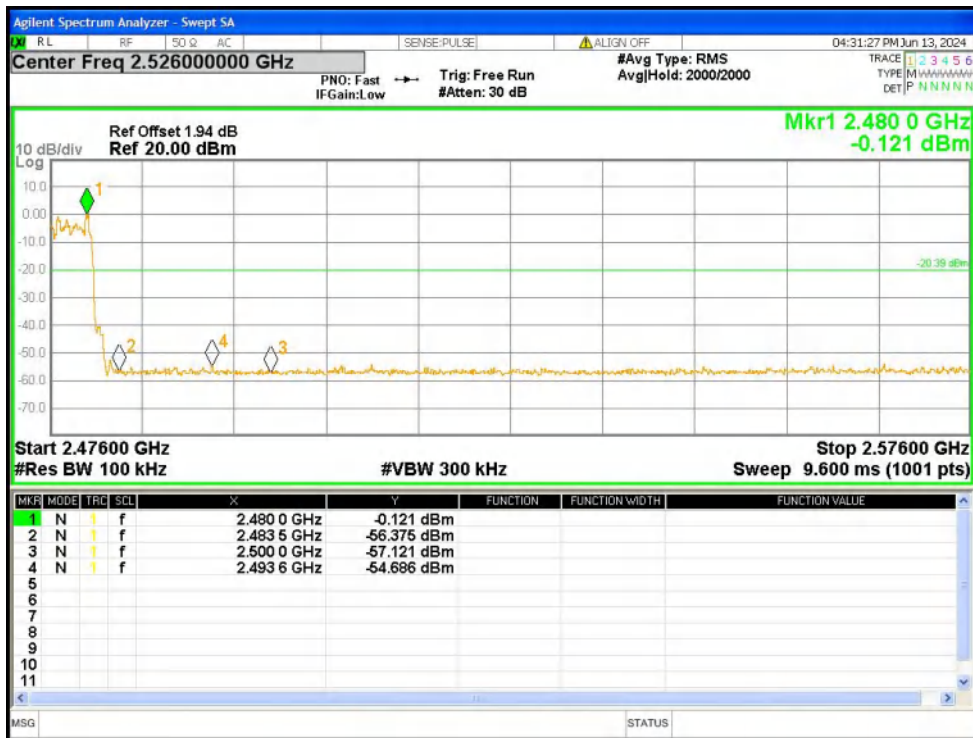

Band Edge(Hopping) NVNT 3-DH5 2480MHz Ant1 Hopping Emission

7. 20DB&99% BANDWIDTH

| | |
|-------------------|------------------------------------|
| Test Requirement: | FCC Part15 C Section 15.247 (a)(1) |
| Test Method: | ANSI C63.10:2013 |

7.1 Test Setup



7.2 Limit

N/A

7.3 Test procedure

1. Set RBW = 30 kHz.
2. Set the video bandwidth (VBW) $\geq 3 \times$ RBW.
3. Detector = Peak.
4. Trace mode = max hold.
5. Sweep = auto couple.
6. Allow the trace to stabilize.
7. Measure the maximum width of the emission that is constrained by the frequencies associated with the two outermost amplitude points (upper and lower frequencies) that are attenuated by 6 dB relative to the maximum level measured in the fundamental emission.

7.4 DEVIATION FROM STANDARD

No deviation.

7.5 Test Result

| Mode | Test channel | 20dB Emission Bandwidth (MHz) | 99%Bandwidth (MHz) | Result |
|----------------|--------------|-------------------------------|--------------------|--------|
| GFSK | Lowest | 0.964 | 0.860 | Pass |
| | Middle | 0.958 | 0.865 | |
| | Highest | 0.945 | 0.866 | |
| $\pi/4$ -DQPSK | Lowest | 1.274 | 1.174 | Pass |
| | Middle | 1.244 | 1.174 | |
| | Highest | 1.277 | 1.170 | |
| 8-DPSK | Lowest | 1.317 | 1.187 | Pass |
| | Middle | 1.275 | 1.183 | |
| | Highest | 1.265 | 1.171 | |

Test plots

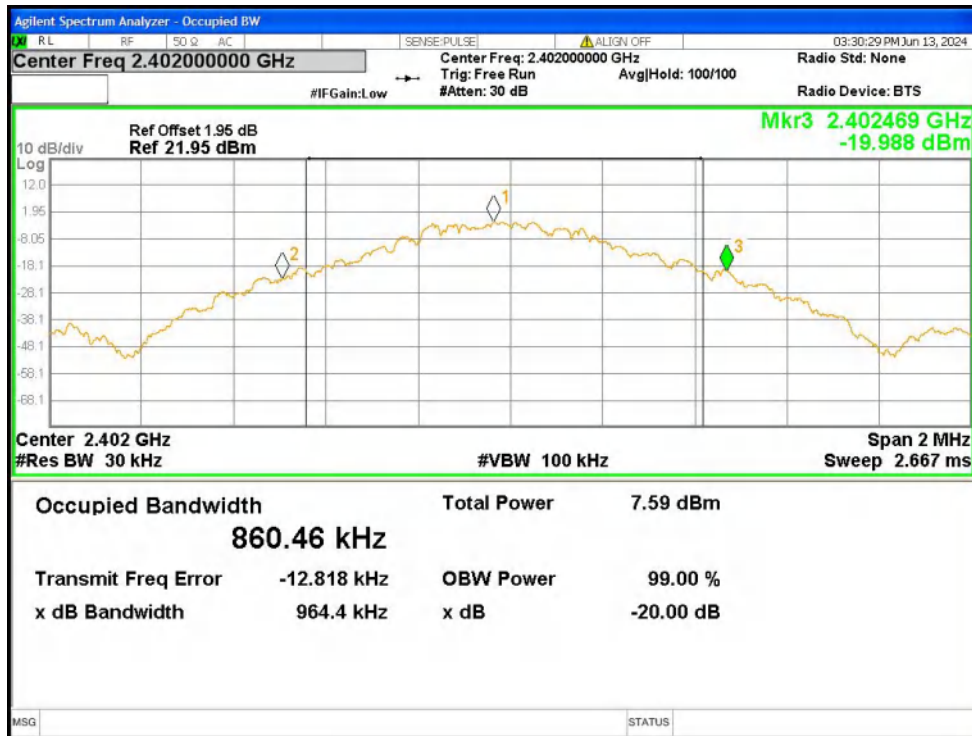

-20dB Bandwidth NVNT 1-DH5 2402MHz Ant1

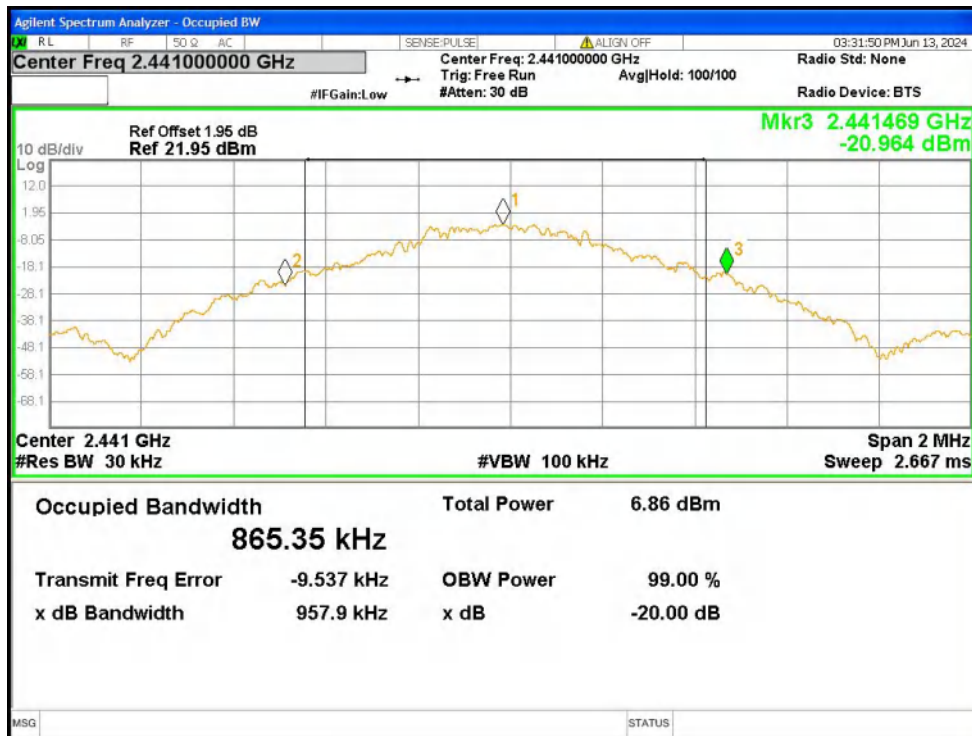

-20dB Bandwidth NVNT 1-DH5 2441MHz Ant1

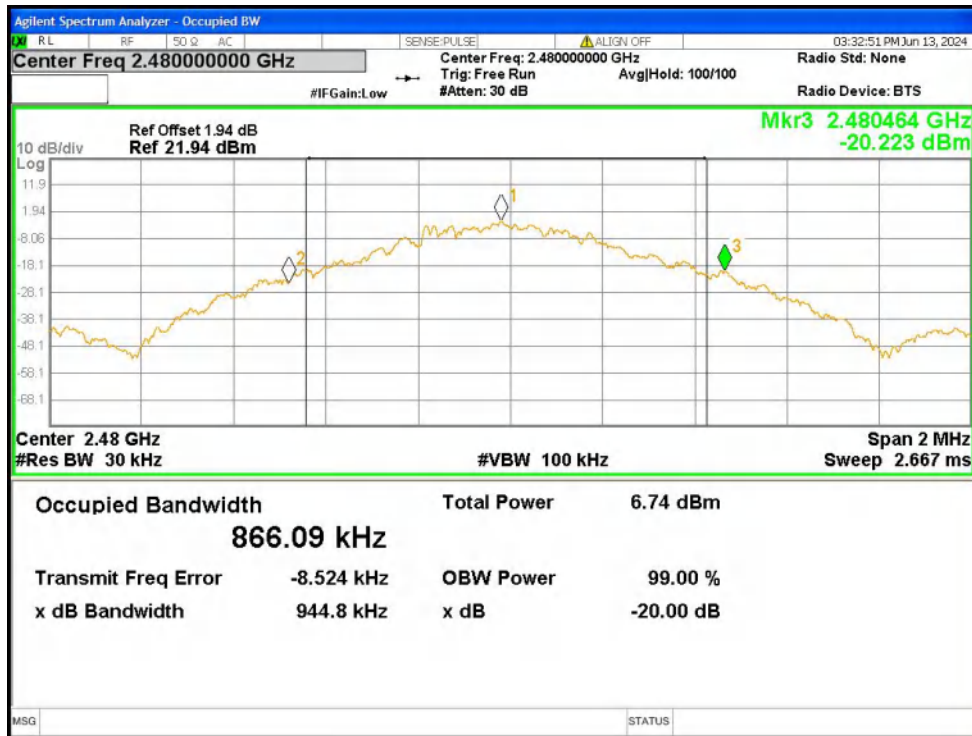

-20dB Bandwidth NVNT 1-DH5 2480MHz Ant1

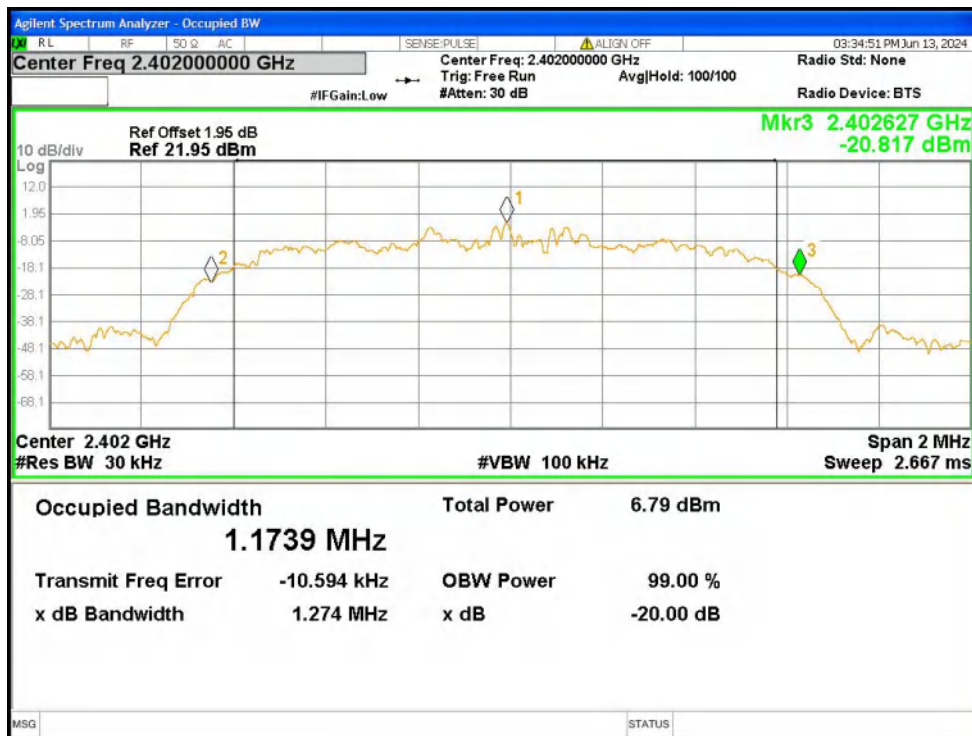

-20dB Bandwidth NVNT 2-DH5 2402MHz Ant1

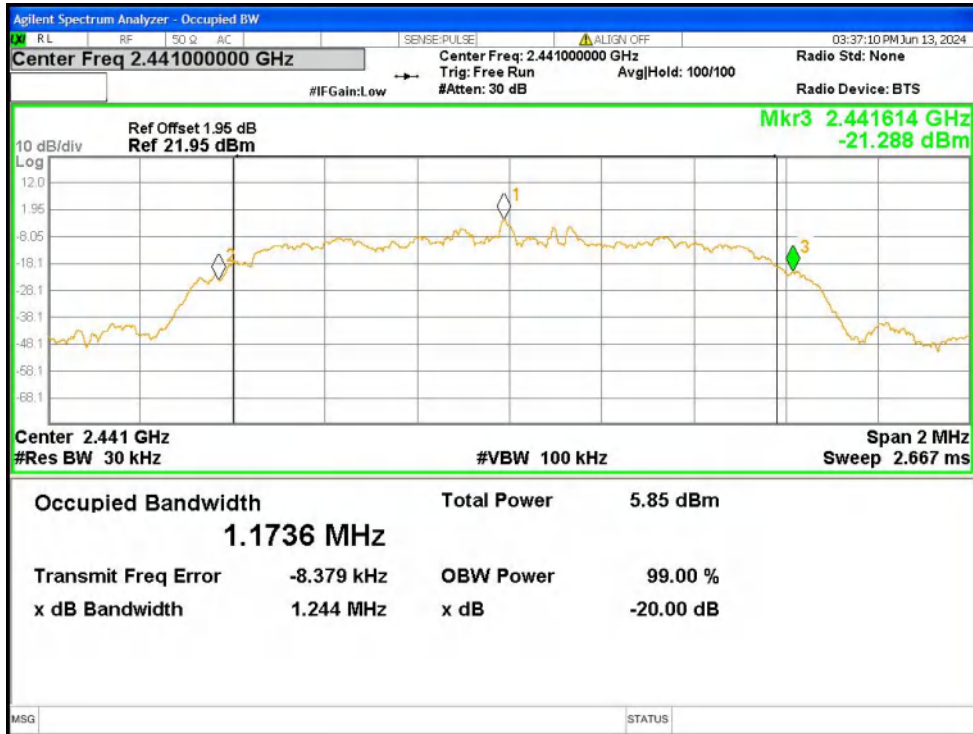

-20dB Bandwidth NVNT 2-DH5 2441MHz Ant1

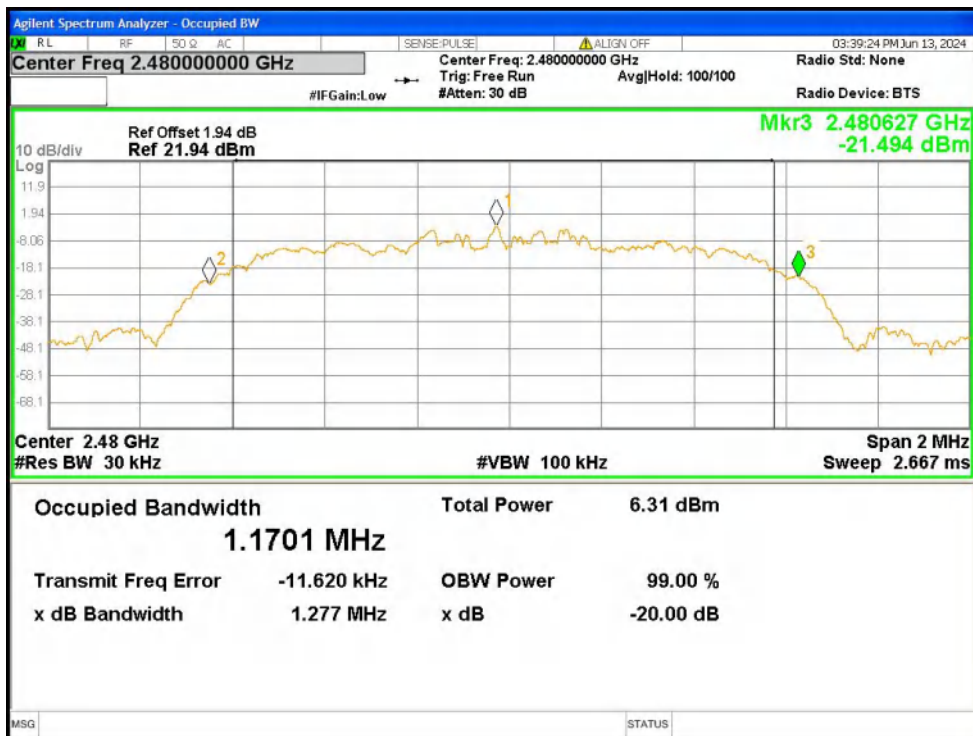

-20dB Bandwidth NVNT 2-DH5 2480MHz Ant1

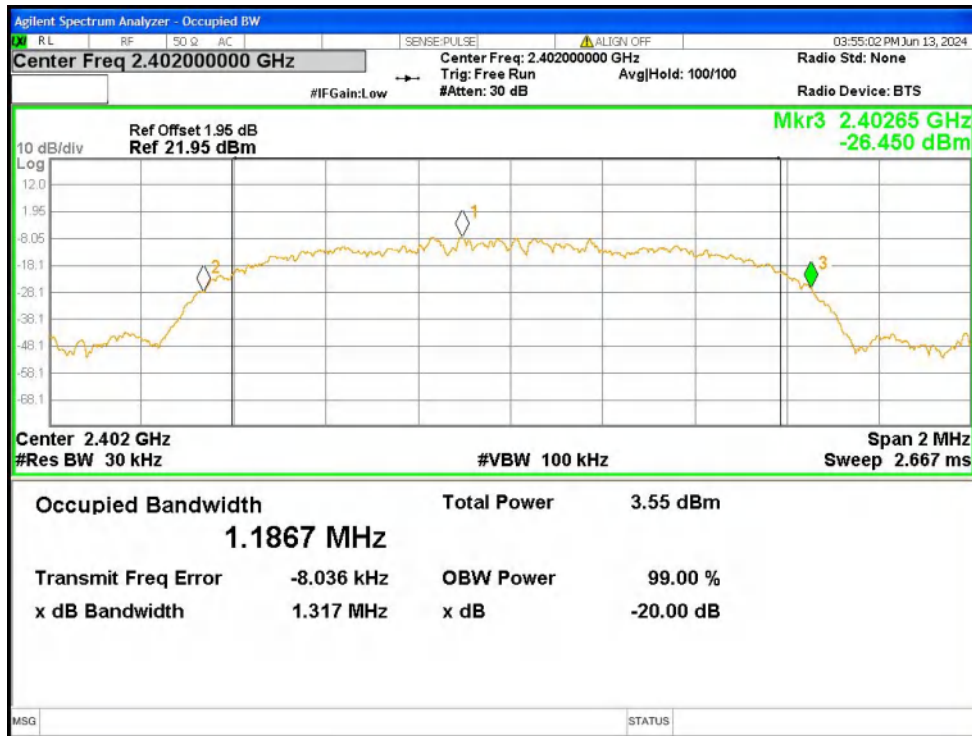

-20dB Bandwidth NVNT 3-DH5 2402MHz Ant1

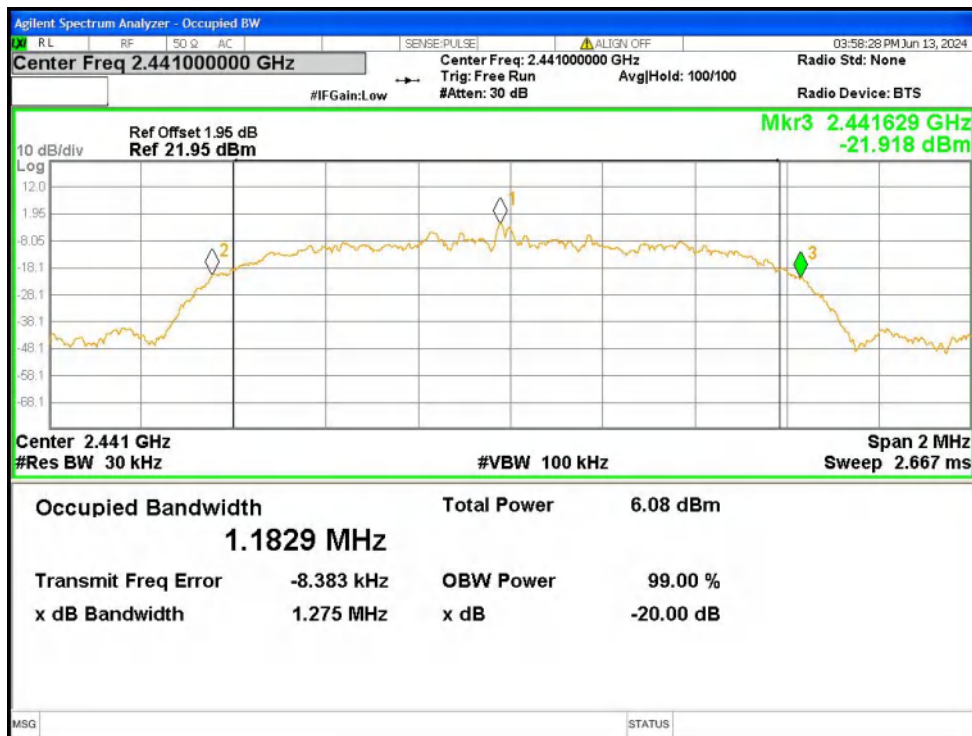

-20dB Bandwidth NVNT 3-DH5 2441MHz Ant1

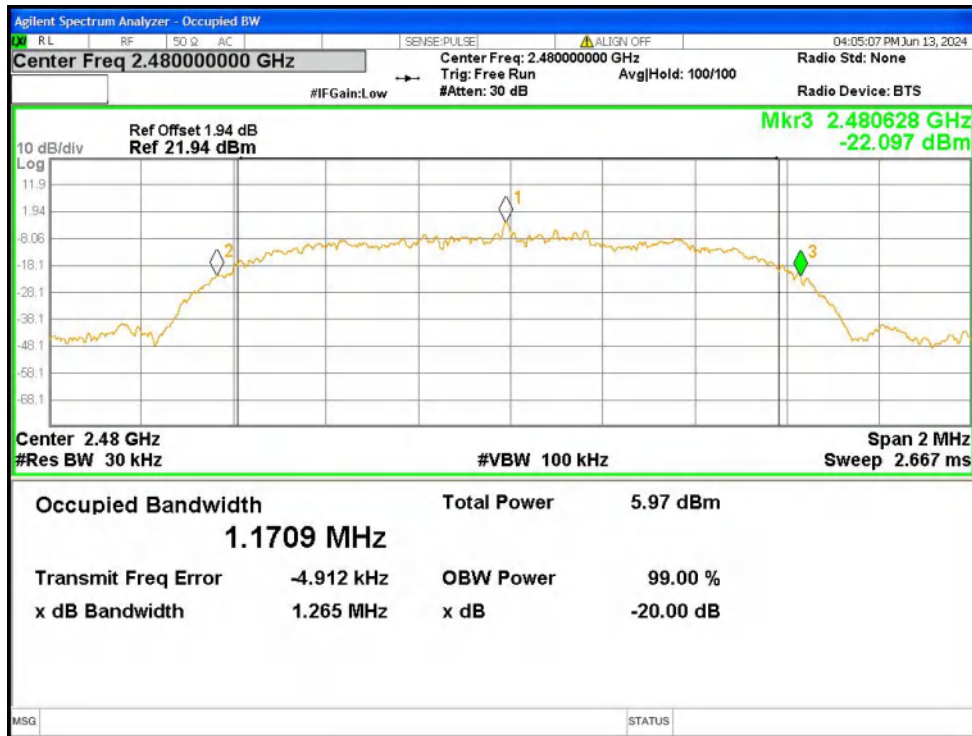

-20dB Bandwidth NVNT 3-DH5 2480MHz Ant1

8. Maximum Peak Output Power

| | |
|-------------------|--|
| Test Requirement: | FCC Part15 C Section 15.247 (b)(1) |
| Test Method: | ANSI C63.10:2013 |
| Limit: | GFSK:30 dBm $\pi/4$ -DQPSK & 8-DPSK:20.97 dBm |

8.1 Block Diagram Of Test Setup**8.2 Limit**

For frequency hopping systems operating in the 2400-2483.5 MHz band employing at least 75 non-overlapping hopping channels, and all frequency hopping systems in the 5725-5850 MHz band: 1 watt. For all other frequency hopping systems in the 2400-2483.5 MHz band: 0.125 watts.

8.3 Test procedure

1. Remove the antenna from the EUT and attach it to the power meter.
2. Keep the EUT in transmitting at lowest, medium and highest channel individually. Record the max value.

8.4 DEVIATION FROM STANDARD

No deviation.

8.5 Test Result

| Mode | Test channel | Peak Output Power (dBm) | FCC Limit (dBm) | Result |
|----------------|--------------|-------------------------|-----------------|--------|
| GFSK | Lowest | 1.17 | 30.00 | Pass |
| | Middle | 0.52 | | |
| | Highest | 0.52 | | |
| $\pi/4$ -DQPSK | Lowest | 1.94 | 21.00 | Pass |
| | Middle | 1.24 | | |
| | Highest | 1.29 | | |
| 8-DPSK | Lowest | -0.59 | 21.00 | Pass |
| | Middle | 1.78 | | |
| | Highest | 1.72 | | |

9. HOPPING CHANNEL SEPARATION

| | |
|-------------------|---|
| Test Requirement: | FCC Part15 C Section 15.247 (a)(1) |
| Test Method: | ANSI C63.10:2013 |
| Receiver setup: | RBW=100KHz, VBW=300KHz, detector=Peak |
| Limit: | GFSK: 20dB bandwidth $\pi/4$ -DQPSK & 8DSK: 0.025MHz or 2/3 of the 20dB bandwidth (whichever is greater) |

9.1 Test Setup



9.2 Test procedure

1. Remove the antenna from the EUT and then connect a low RF cable from the antenna port to the spectrum.
2. Set the spectrum analyzer: RBW = 30kHz. VBW = 100kHz , Span = 2.0MHz. Sweep = auto; Detector Function = Peak. Trace = Max hold.
3. Allow the trace to stabilize. Use the marker-delta function to determine the separation between the peaks of the adjacent channels. The limit is specified in one of the subparagraphs of this Section Submit this plot.

9.3 DEVIATION FROM STANDARD

No deviation.

9.4 Test Result

| Modulation | Test Channel | Separation (MHz) | Limit(MHz) | Result |
|----------------|--------------|------------------|------------|--------|
| GFSK | Low | 0.988 | 0.964 | PASS |
| GFSK | Middle | 0.988 | 0.958 | PASS |
| GFSK | High | 1.006 | 0.945 | PASS |
| $\pi/4$ -DQPSK | Low | 1.064 | 0.849 | PASS |
| $\pi/4$ -DQPSK | Middle | 1.05 | 0.829 | PASS |
| $\pi/4$ -DQPSK | High | 1.086 | 0.851 | PASS |
| 8-DPSK | Low | 0.982 | 0.878 | PASS |
| 8-DPSK | Middle | 0.912 | 0.850 | PASS |
| 8-DPSK | High | 1.006 | 0.843 | PASS |

Test plots

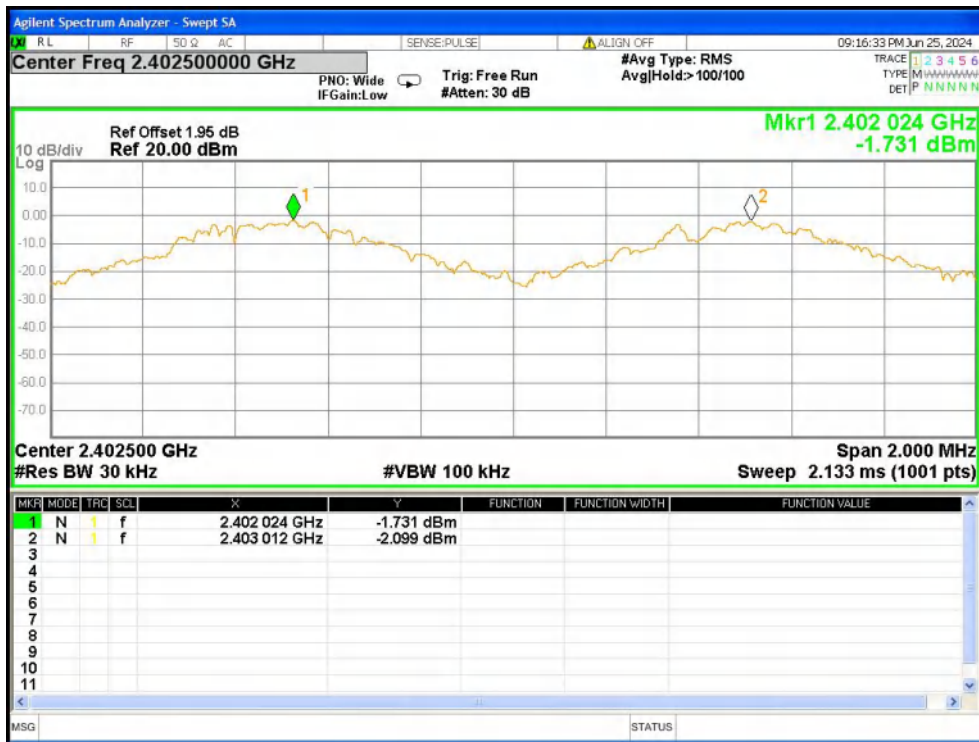

CFS NVNT 1-DH5 2402MHz Ant1

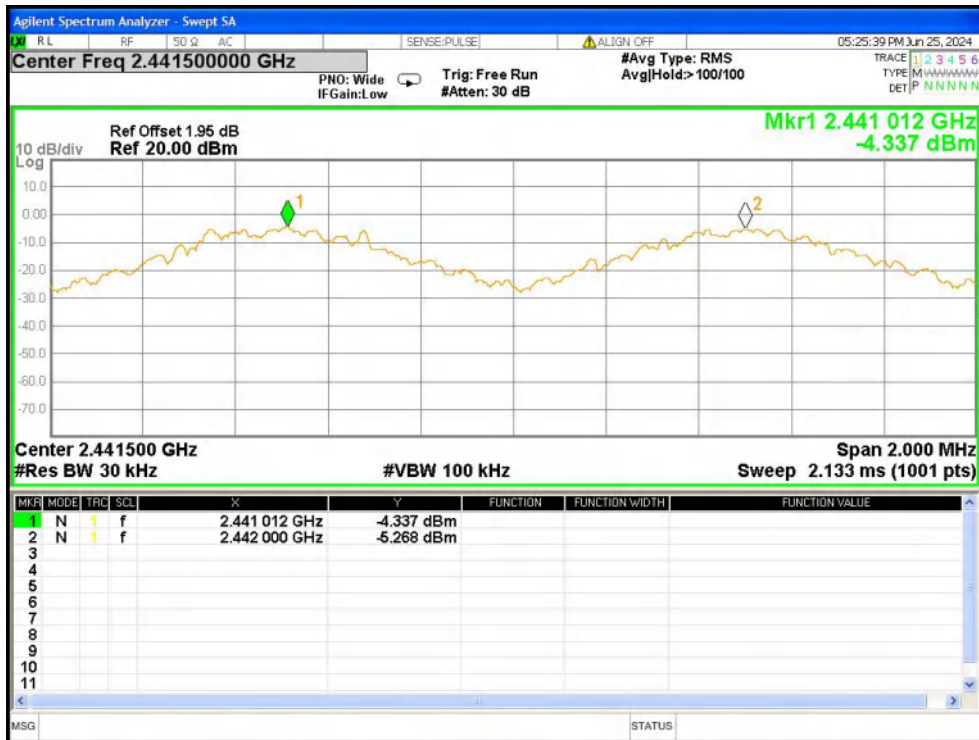

CFS NVNT 1-DH5 2441MHz Ant1

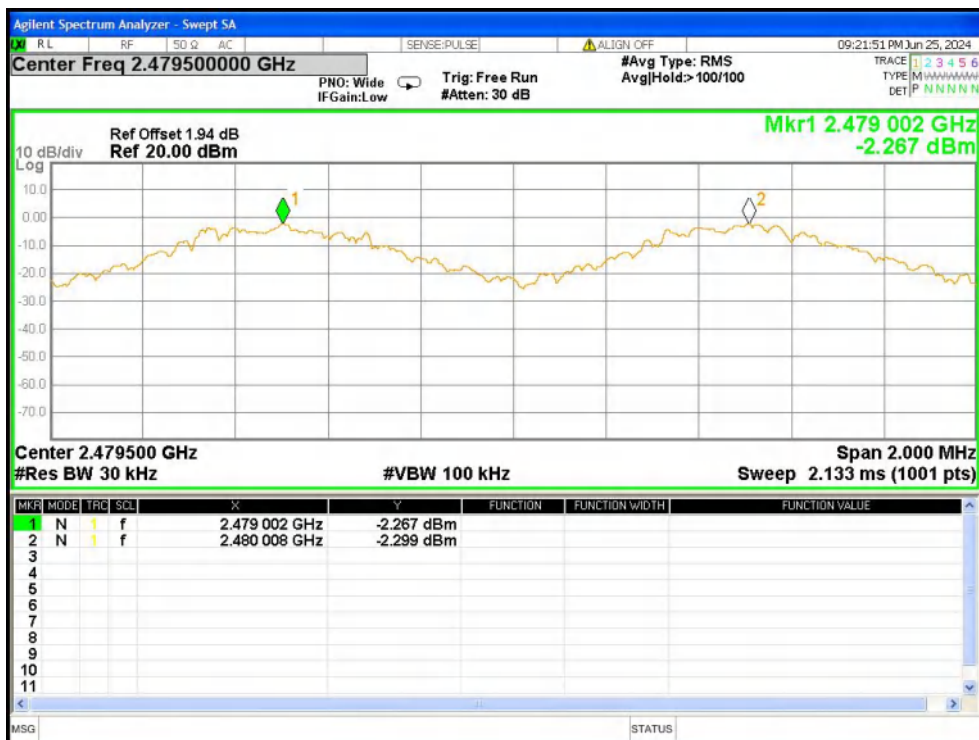

CFS NVNT 1-DH5 2480MHz Ant1

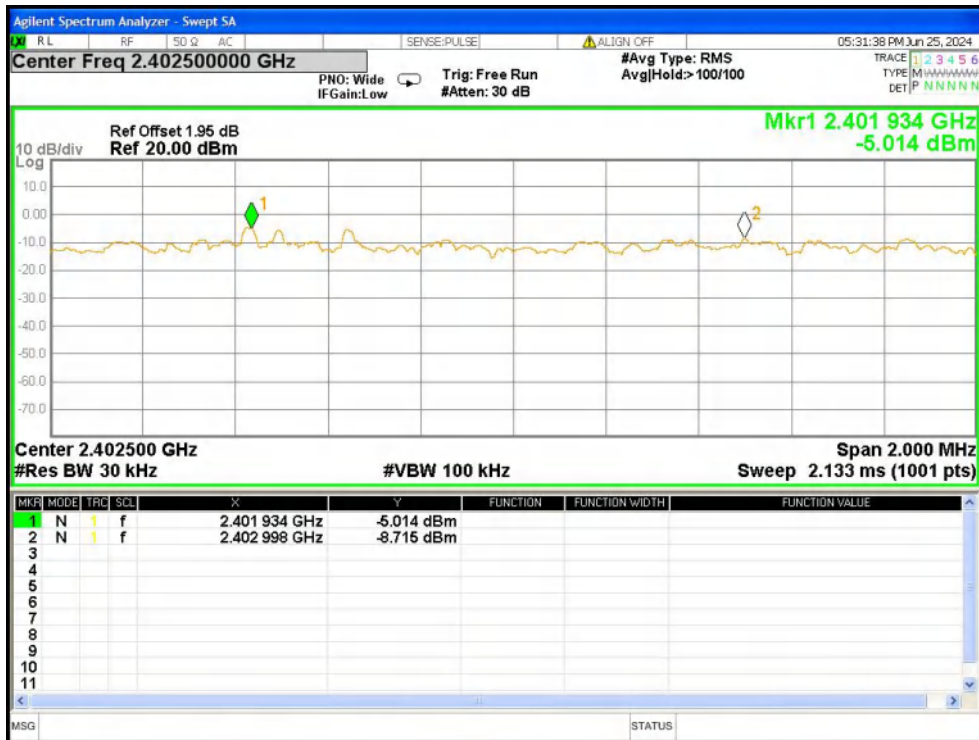

CFS NVNT 2-DH5 2402MHz Ant1

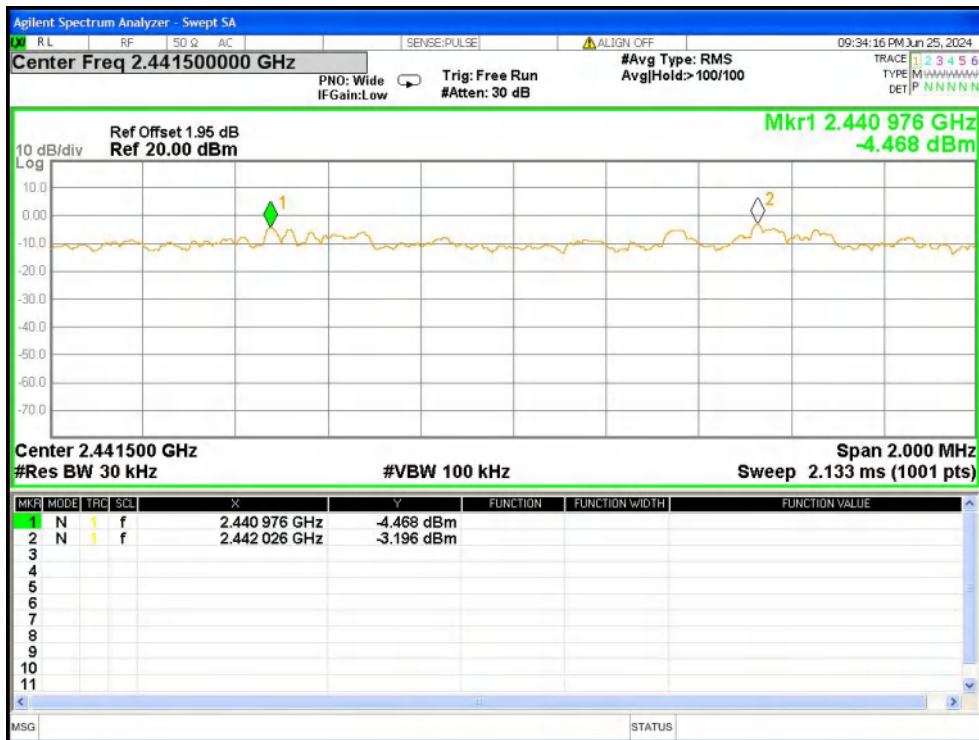

CFS NVNT 2-DH5 2441MHz Ant1

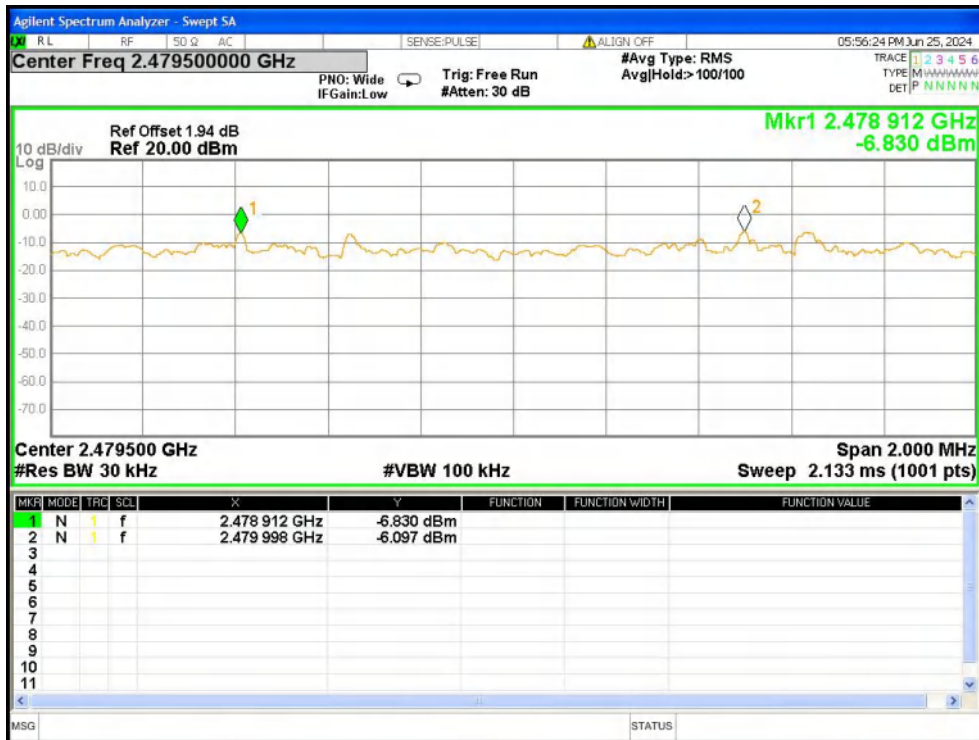

CFS NVNT 2-DH5 2480MHz Ant1

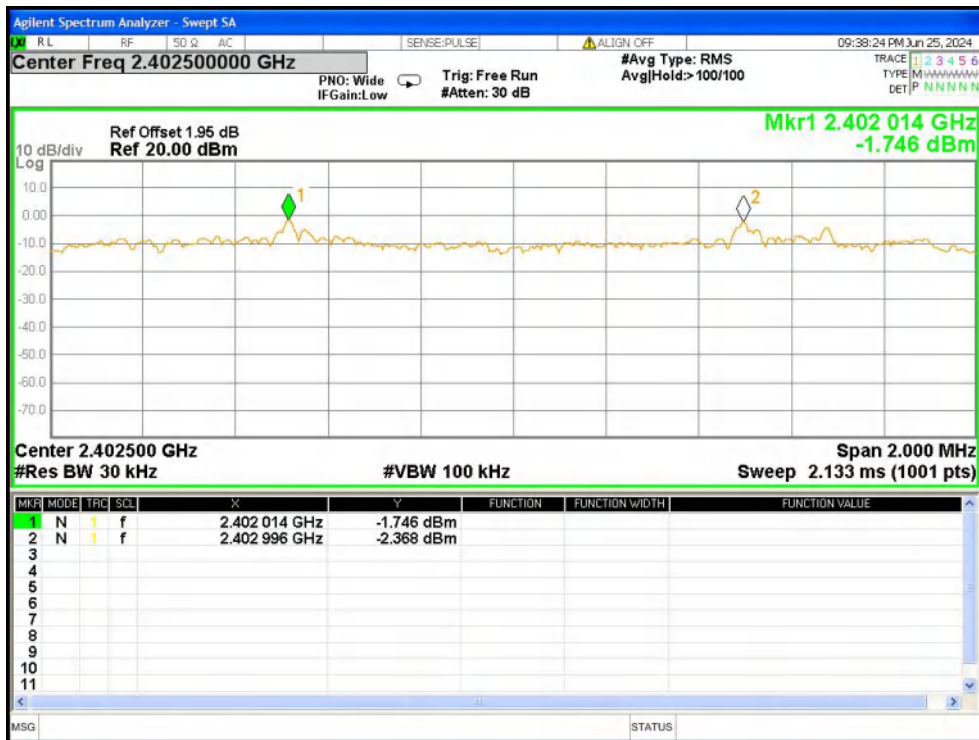

CFS NVNT 3-DH5 2402MHz Ant1

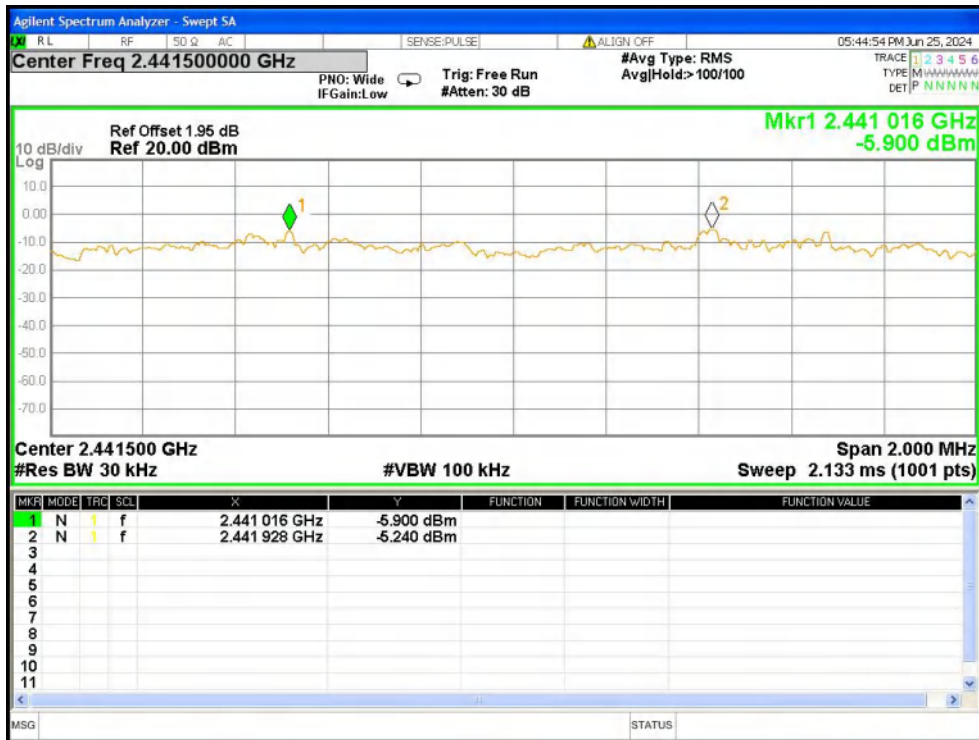

CFS NVNT 3-DH5 2441MHz Ant1

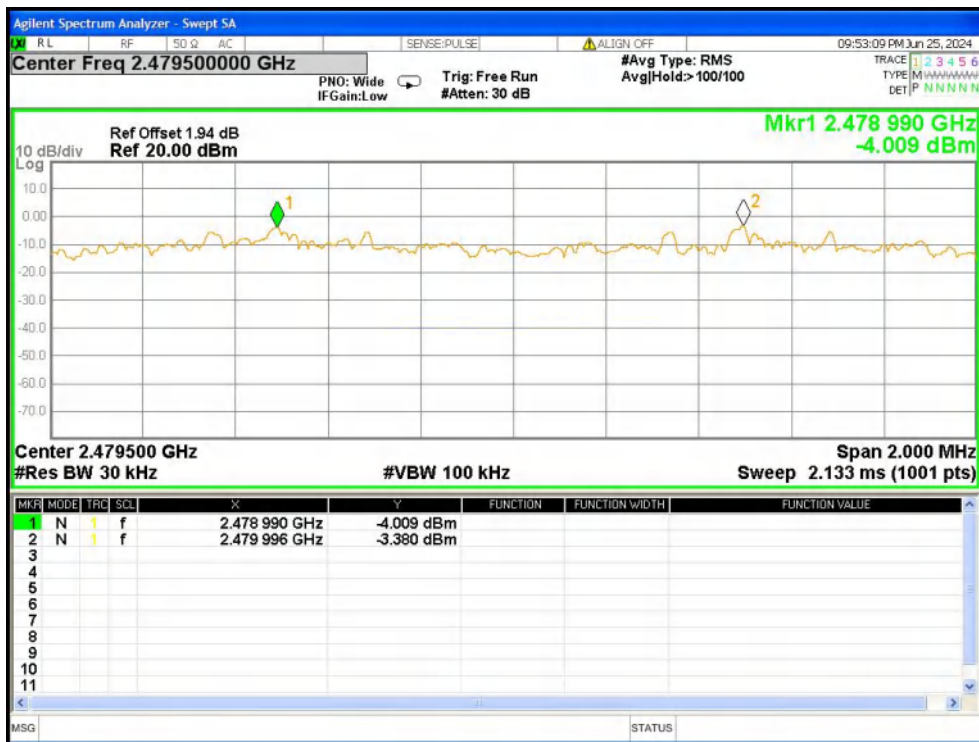

CFS NVNT 3-DH5 2480MHz Ant1

10.NUMBER OF HOPPING FREQUENCY

| | |
|-------------------|--|
| Test Requirement: | FCC Part15 C Section 15.247 (a)(1)(iii) |
| Test Method: | ANSI C63.10:2013 |
| Receiver setup: | RBW=100kHz, VBW=300kHz, Frequency range=2400MHz-2483.5MHz, Detector=Peak |
| Limit: | 15 channels |

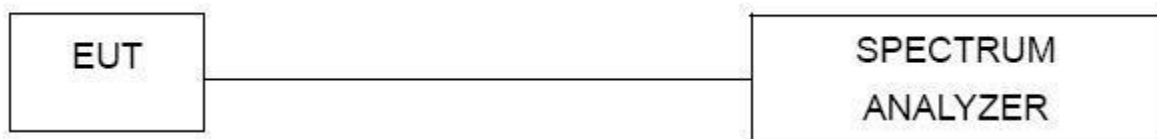
10.1 Test Setup**10.2 Test procedure**

1. Remove the antenna from the EUT and then connect a low RF cable from the antenna port to the spectrum.
2. Set the spectrum analyzer: RBW = 100kHz. VBW = 300kHz. Sweep = auto; Detector Function = Peak. Trace = Max hold.
3. Allow the trace to stabilize. It may prove necessary to break the span up to sections. in order to clearly show all of the hopping frequencies. The limit is specified in one of the subparagraphs of this Section.
4. Set the spectrum analyzer: Start Frequency = 2.4GHz, Stop Frequency = 2.4835GHz. Sweep=auto;

10.3 DEVIATION FROM STANDARD

No deviation.

10.4 Test Result

Test Plots:
79 Channels in total

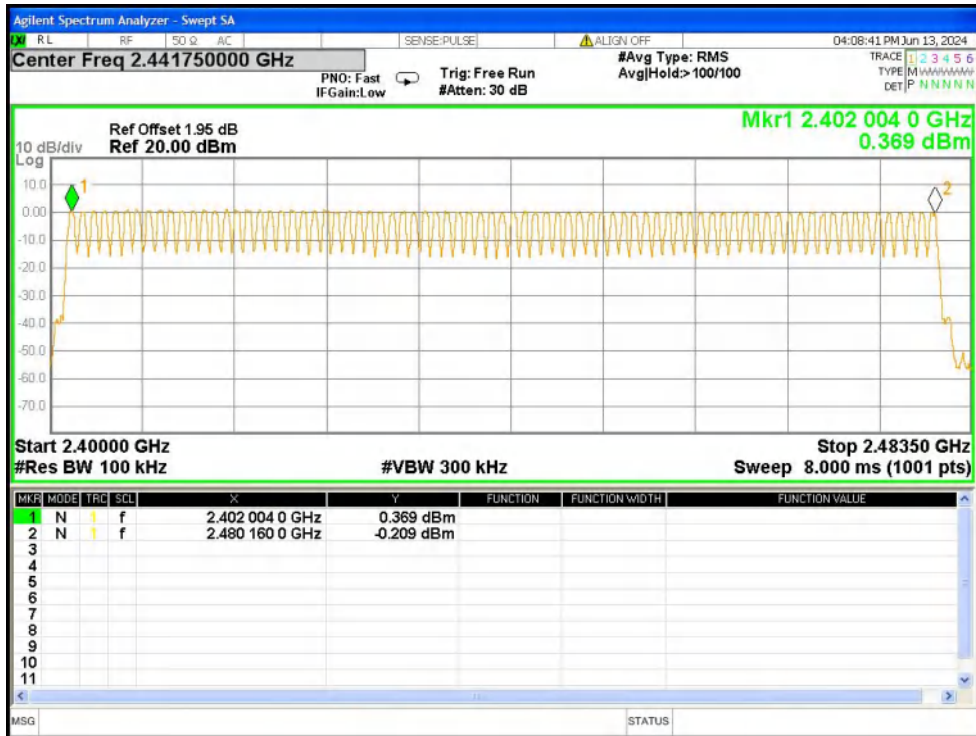

Hopping No. NVNT 1-DH5 Ant1

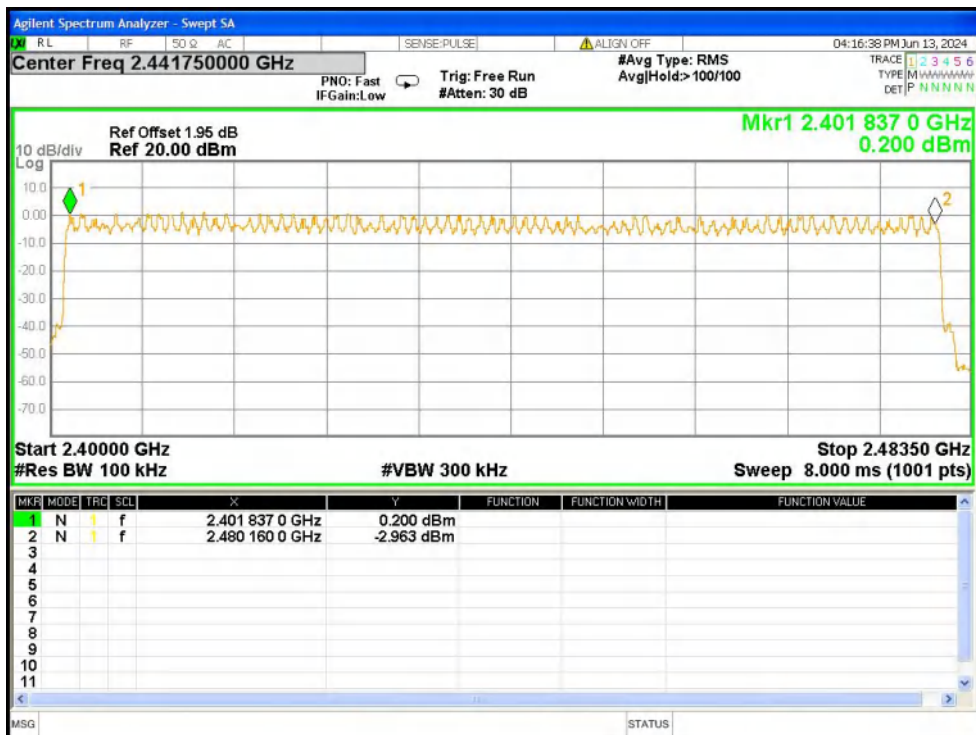

Hopping No. NVNT 2-DH5 Ant1



Hopping No. NVNT 3-DH5 Ant1

11. DWELL TIME

| | |
|-------------------|---|
| Test Requirement: | FCC Part15 C Section 15.247 (a)(1)(iii) |
| Test Method: | ANSI C63.10:2013 |
| Receiver setup: | RBW=1MHz, VBW=3MHz, Span=0Hz, Detector=Peak |
| Limit: | ≤0.4 Second |

11.1 Test Setup



11.2 Test procedure

1. Remove the antenna from the EUT and then connect a low RF cable from the antenna port to the spectrum.
2. Set spectrum analyzer span = 0Hz;
3. Set RBW = 1MHz and VBW = 3MHz. Sweep = as necessary to capture the entire dwell time per hopping channel. Set the EUT for DH1/DH2/2DH1/2DH3/3DH1/3DH3 DH5/2DH5/3DH5 packet transmitting.
4. Use the marker-delta function to determine the dwell time. If this value varies with different modes of operation (e.g.. data rate. modulation format. etc.). repeat this test for each variation. The limit is specified in one of the subparagraphs of this Section. Submit this plot(s).

11.3 DEVIATION FROM STANDARD

No deviation.

11.4 Test Result

| Mode | Frequency (MHz) | Antenna | Pulse Time (ms) | Total Dwell Time (ms) | Burst Count | Period Time (ms) | Limit (ms) | Verdict |
|-------|-----------------|---------|-----------------|-----------------------|-------------|------------------|------------|---------|
| 1-DH5 | 2402 | Ant1 | 2.906 | 313.848 | 108 | 31600 | 400 | Pass |
| 1-DH5 | 2441 | Ant1 | 2.905 | 339.885 | 117 | 31600 | 400 | Pass |
| 1-DH5 | 2480 | Ant1 | 2.906 | 284.788 | 98 | 31600 | 400 | Pass |
| 2-DH5 | 2402 | Ant1 | 2.912 | 308.672 | 106 | 31600 | 400 | Pass |
| 2-DH5 | 2441 | Ant1 | 2.909 | 337.444 | 116 | 31600 | 400 | Pass |
| 2-DH5 | 2480 | Ant1 | 2.909 | 322.899 | 111 | 31600 | 400 | Pass |
| 3-DH5 | 2402 | Ant1 | 2.912 | 299.936 | 103 | 31600 | 400 | Pass |
| 3-DH5 | 2441 | Ant1 | 2.915 | 259.435 | 89 | 31600 | 400 | Pass |
| 3-DH5 | 2480 | Ant1 | 2.914 | 262.26 | 90 | 31600 | 400 | Pass |

Note1: Total Dwell Time (ms)=Pulse Time (ms)*Burst Count

Note2: Only the worst test data DH5/2DH5/3DH5 put in the report

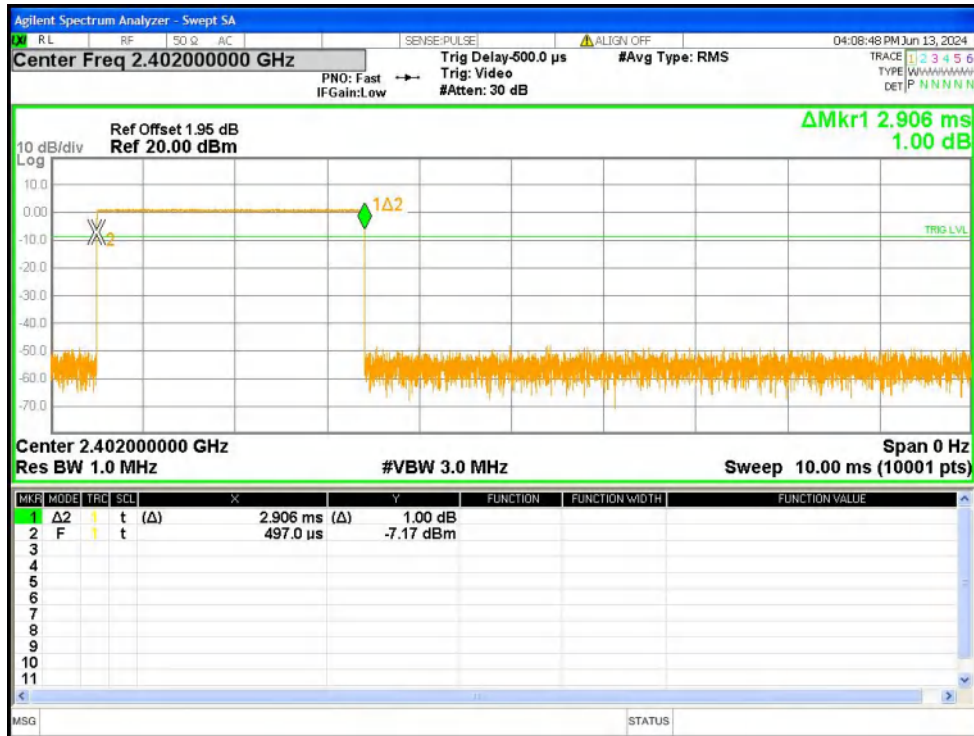

Dwell NVNT 1-DH5 2402MHz Ant1 One Burst

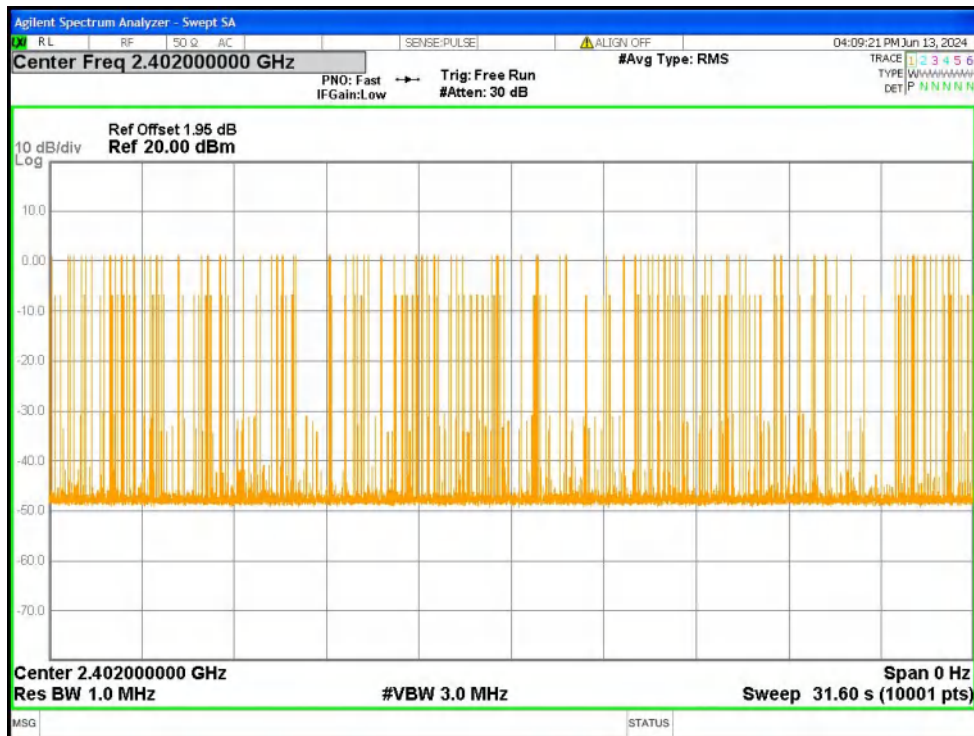

Dwell NVNT 1-DH5 2402MHz Ant1 Accumulated

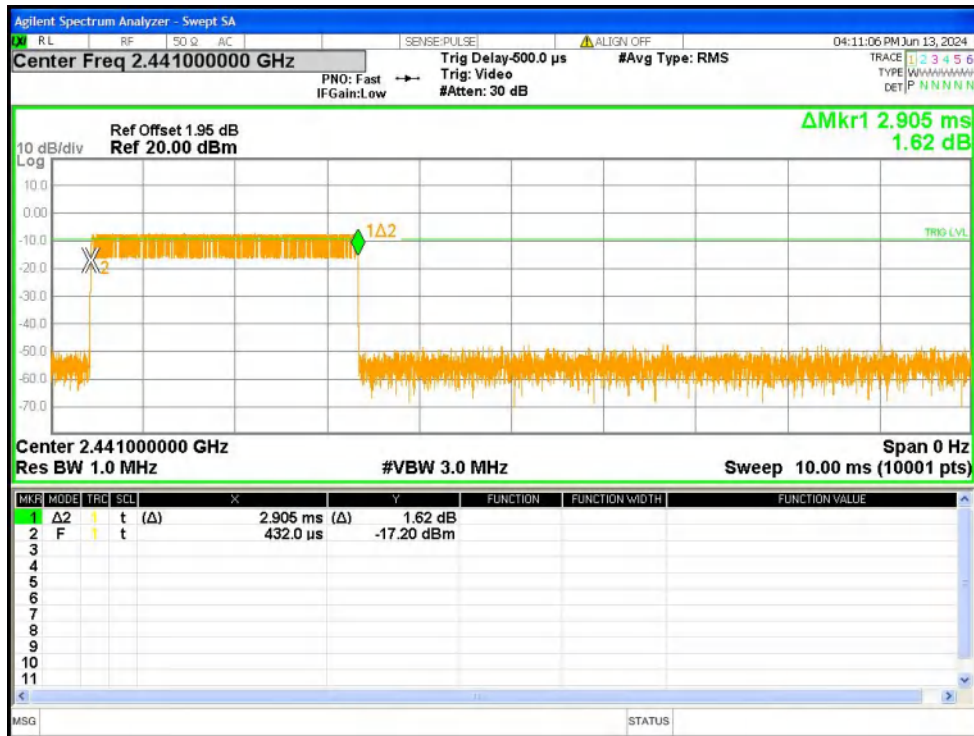

Dwell NVNT 1-DH5 2441MHz Ant1 One Burst



Dwell NVNT 1-DH5 2441MHz Ant1 Accumulated

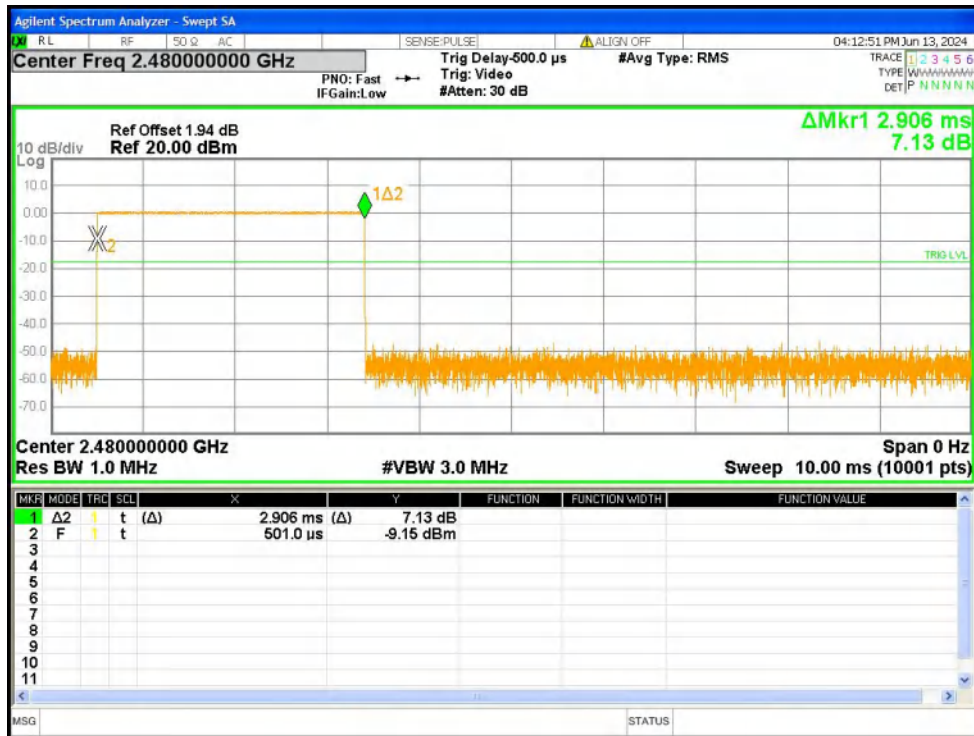

Dwell NVNT 1-DH5 2480MHz Ant1 One Burst

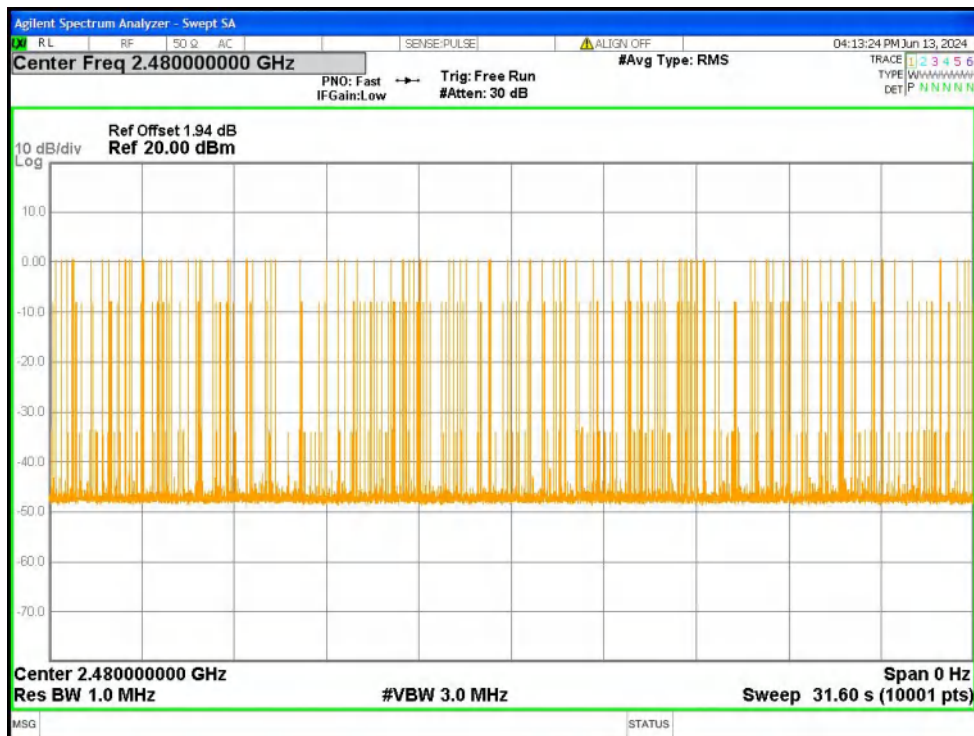

Dwell NVNT 1-DH5 2480MHz Ant1 Accumulated

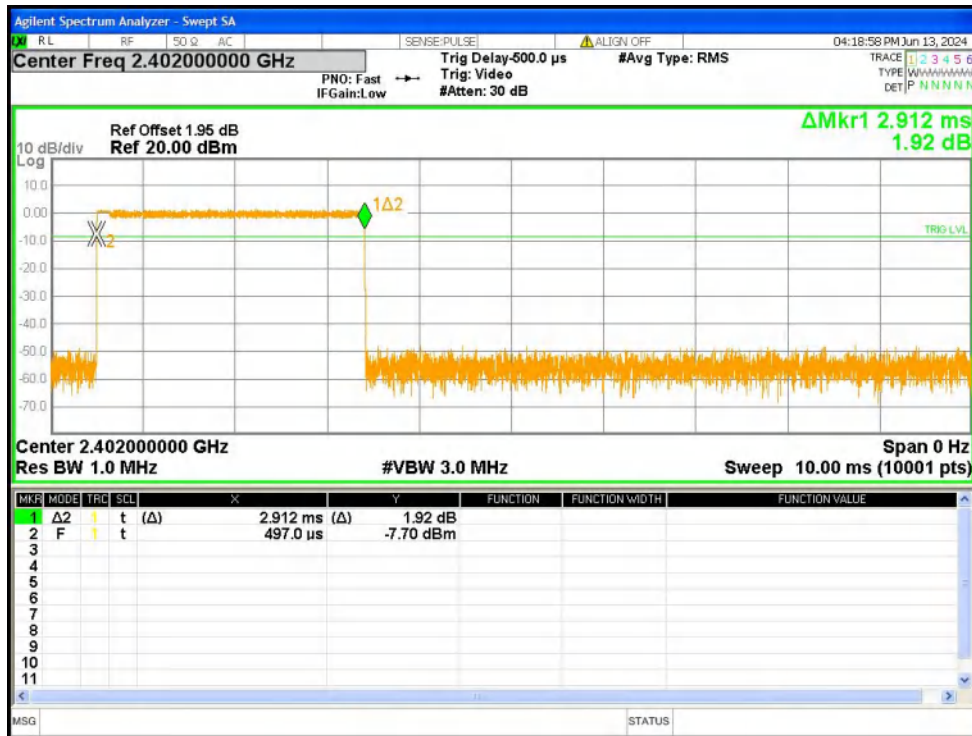

Dwell NVNT 2-DH5 2402MHz Ant1 One Burst

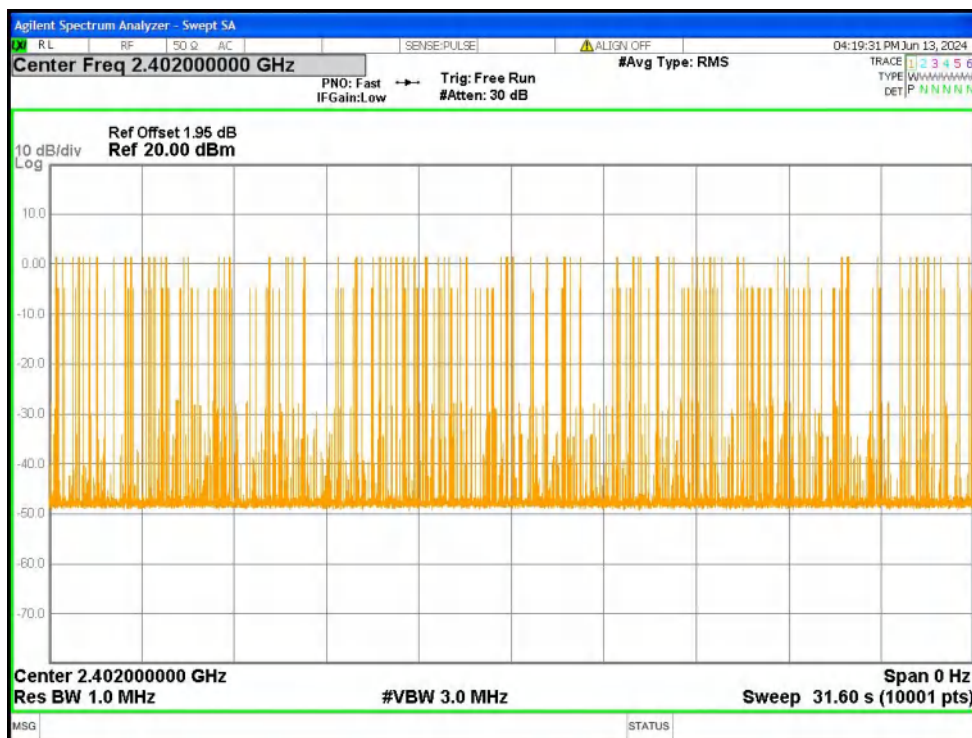

Dwell NVNT 2-DH5 2402MHz Ant1 Accumulated



Dwell NVNT 2-DH5 2441MHz Ant1 One Burst



Dwell NVNT 2-DH5 2441MHz Ant1 Accumulated

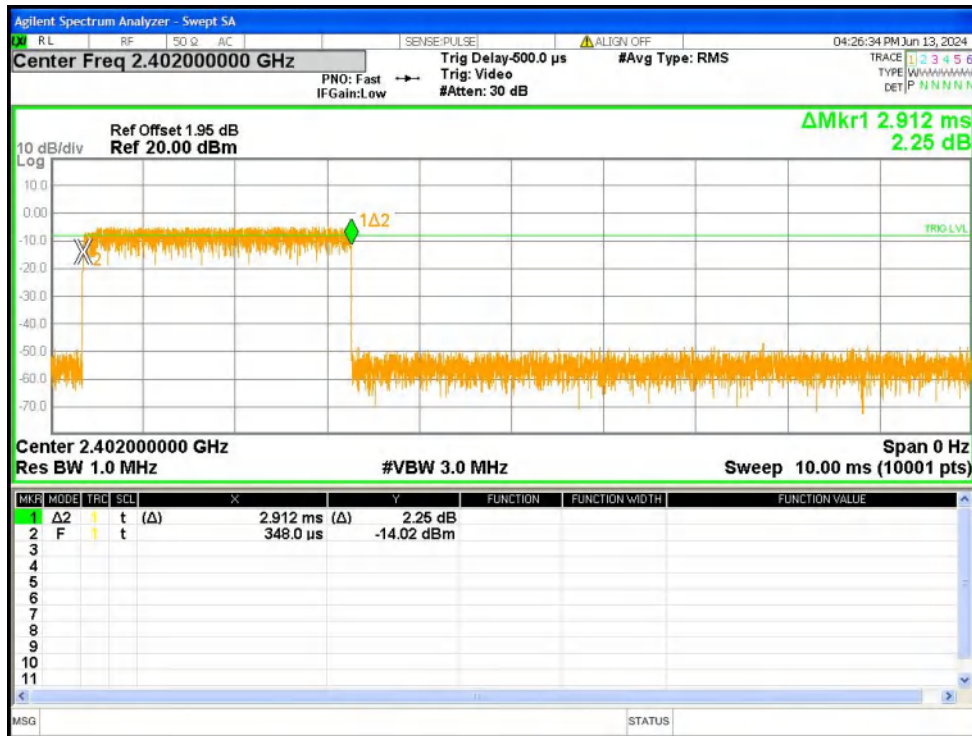

Dwell NVNT 3-DH5 2402MHz Ant1 One Burst

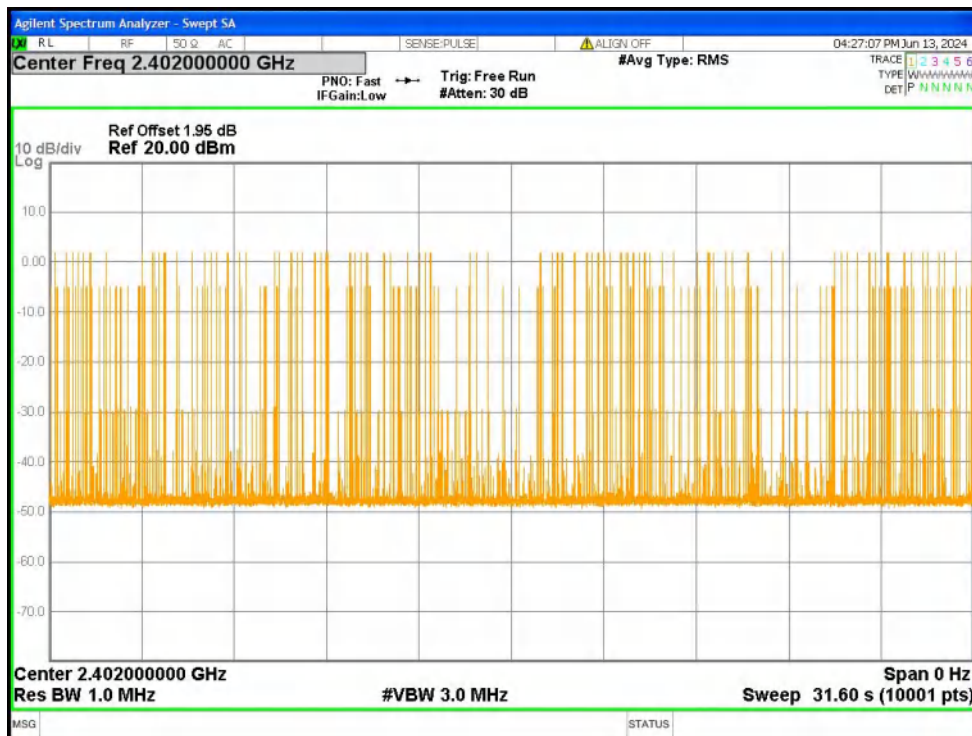

Dwell NVNT 3-DH5 2402MHz Ant1 Accumulated

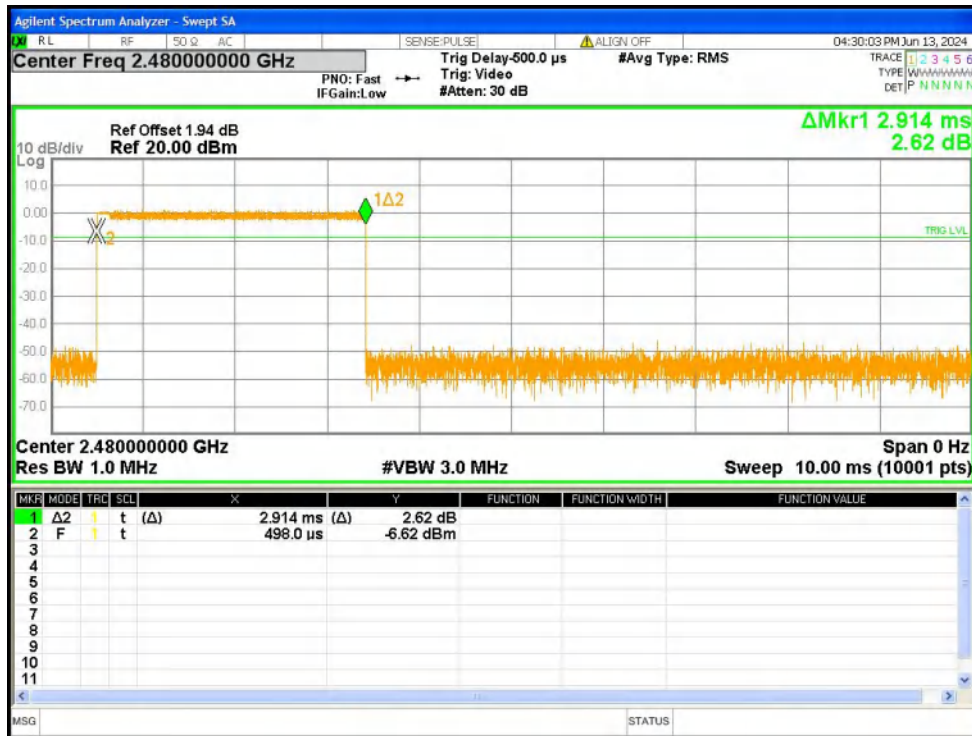

Dwell NVNT 3-DH5 2480MHz Ant1 One Burst



Dwell NVNT 3-DH5 2480MHz Ant1 Accumulated

12. Antenna Requirement

| | |
|--|-------------------------------------|
| Standard requirement: | FCC Part15 C Section 15.203 /247(c) |
| <p>15.203 requirement: An intentional radiator shall be designed to ensure that no antenna other than that furnished by the responsible party shall be used with the device. The use of a permanently attached antenna or of an antenna that uses a unique coupling to the intentional radiator, the manufacturer may design the unit so that a broken antenna can be replaced by the user, but the use of a standard antenna jack or electrical connector is prohibited.</p> <p>15.247(c) (1)(i) requirement: (i) Systems operating in the 2400-2483.5 MHz band that is used exclusively for fixed. Point-to-point operations may employ transmitting antennas with directional gain greater than 6dBi provided the maximum conducted output power of the intentional radiator is reduced by 1 dB for every 3 dB that the directional gain of the antenna exceeds 6dBi.</p> | |
| EUT Antenna: | |
| The antenna is PCB Antenna, the best case gain of the antennas is -1.2dBi, reference to the appendix II for details | |

13. Test Setup Photo

Reference to the appendix I for details.

14. EUT Constructional Details

Reference to the appendix II for details.

*****REPORT*****