

User Manual

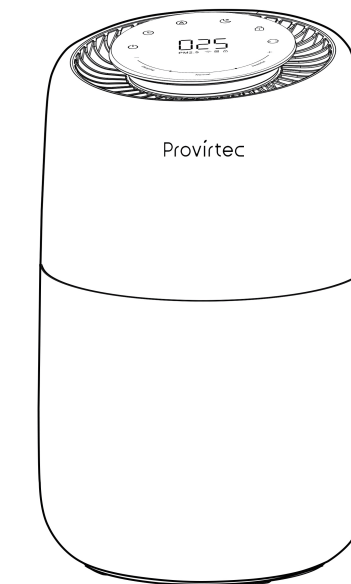

ClearBreathe Smart Air Purifier

AP-01

Contents

- Important Safety Instructions 1
- Package Contents 3
- Specification 3
- Introduction 4
- Assembly Instructions 6
- Controls & Indicators 8
- App Download Instructions 10
- Maintenance & Care 11
- Troubleshooting 13
- Notice 15
- Warranty 16
- Contact Us 16

1. Important Safety Instructions

Movement

Make sure to stop the main unit from operating and unplug the power adapter before moving.

Assembly

- Place the air purifier on a stable surface to avoid vibration and noise.
- The air inlet of the main unit should be at least 10 cm (3.94 in) away from walls or other obstructions to avoid blocking the air inlet.

Cleaning and Storage

- Frequently clean the dust, hair, and impurities from the surface of the filters to reduce bacterial growth.
- Clean the dust and impurities blocking the air inlet to prevent a decrease in air intake.
- If the air purifier will not be used for an extended period of time, cover the air outlet on the top of the air purifier to prevent dust from settling on the grille and fan blades, and to keep them clean.

Power Supply

Follow the instructions below when using the power adapter and outlet to avoid fire, electric shock, or damage.

- The air purifier is directly powered by the power adapter and does not support charging or battery storage.
- Do not excessively pull, twist, or bend the power cord, as this may expose the wire core or cause the core to break.
- Connect the power adapter to a suitable power outlet (AC 100-240V, two-prong flat power outlet).
- Use the provided power adapter only. Do not use other brands of power adapters.
- Disconnect the power before performing maintenance or moving the air purifier.
- If the power adapter is damaged, you must purchase a dedicated power adapter for replacement from the manufacturer.

During use

- If abnormalities such as unusual noise, odor, high temperature, or irregular fan rotation occur, stop using the air purifier immediately.
- Do not insert fingers or foreign objects into the air inlet, air outlet, or detection port to avoid accidents.
- Do not allow hair or other fabrics to come near to the main unit, to avoid being pulled in or blocking the air inlet and the air outlet.
- Do not sit on, lean on, or tilt the main unit to avoid malfunction of the air purifier.
- Do not use the air purifier simultaneously with household gas appliances, such as gas stoves, gas water heaters, to avoid igniting the air purifier.
- Do not pour liquids, powders, or small particles from the air outlet into the main unit to avoid malfunction or safety accidents.

Use Restrictions

Do not use in the following situations, as it may result in electric shock, fire, or other damage.

- Keep the main unit, especially the air inlet, away from open flame devices, such as candles, incense burners, stoves, fireplaces, cigarettes, firecrackers, lighters, electronic ignition spray guns, igniters, fire pits, etc.
- Keep the main unit away from high-temperature heating devices, such as electric heaters, space heaters, foot warmers, electric stoves, irons, etc. Keep flammable materials away from the main unit.
- Do not place the air purifier on an uneven, sloping, or small tabletop where it may easily tip over.
- Do not place the air purifier in bathrooms, basements, or other damp locations where it may get wet.
- This air purifier is not intended for use by persons (including children) with reduced physical, sensory, or mental capabilities, or who lack of experience and knowledge, unless they have been given supervision or instruction regarding use of the air purifier by a person responsible for their safety.
- Keep away from children to prevent them from playing with the air purifier.

2. Package Contents

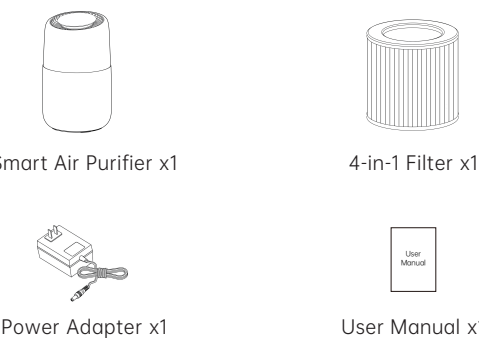

3. Specification

Product	ClearBreathe Smart Air Purifier
Model No.	AP-01
Input	100-240V~ 50/60Hz
Output	24V = 1.5A
Dimensions	8.1*8.1*13.5in/206*206*342mm
CADR	200m ³ /h /CFM117
CCM	F4
HEPA Level	H13(>0.3µm particle capture rate >99.97%)

4. Introduction

A- Control Panel	B- Air Quality Indicator	C- Main Unit
D- Air Inlet / Fabric Pre-filter	E- Air Outlet	F- Power Port
G- PM2.5 Detection Port	H- Filter Compartment / 4-in-1 Filter(inside)	

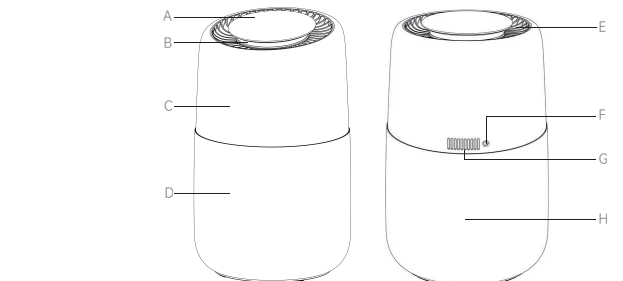

About the Filter

5-Stage deep filtration system

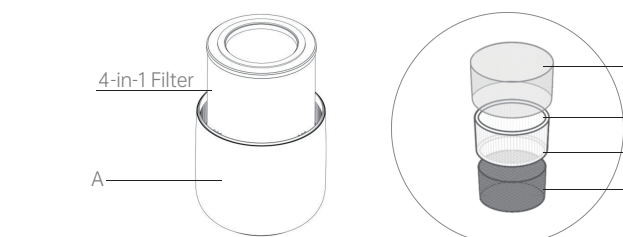

A- Fabric Pre-filter

- Captures long strip-shaped objects such as cotton lint, fibers, hair, and pet fur.
- Maximizes the filter life by protecting it.
- Supports washing and cleaning with water (must be air-dried after rinsing).

B- Nylon Pre-filter

- Captures fine foreign objects and large particles, such as cotton fluff and small hair.
- Performs pre-filtration of large airborne particles, blocking them before they reach the main filter, making it easier to clean and maintain.

C- Main Filter

- Deeply filters small particles such as tiny dust, smoke particles, pollen, and pet dander.

D- HEPA High-efficiency Filter

- Physically adsorbs smoke, odors, allergens, and other ultra-fine particles. Removes at least 99.97% of particles 0.3µm in diameter.
- Filters compounds such as formaldehyde, benzene, ammonia, hydrogen sulfide, and volatile organic compounds (VOCs).

E- Activated Carbon Filter

- Adsorbs gaseous pollutants from pets, kitchens, secondhand smoke, indoor mold, etc., and reduces odors in the environment.

About the Air Quality Indicator

Indicator Color	PM 2.5 Value	Air Quality
Blue	0-35ug/m ³	Very Good
Green	36-75ug/m ³	Good
Orange	76-115ug/m ³	Moderate
Red	> 116ug/m ³	Poor

About the Control Panel

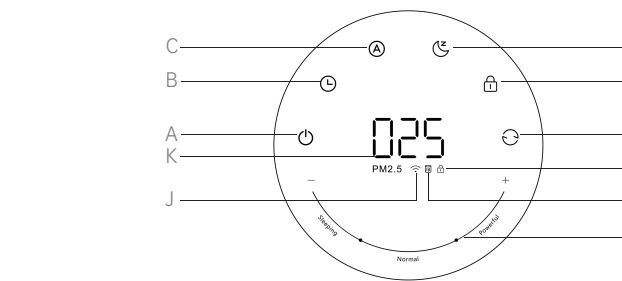

A- On/Off	B- Timer	C- Auto Mode
D- Sleep Mode	E- Child Lock	F- Filter Reset
G- Child Lock Indicator	H- Filter Replacement Indicator	I- Speed
J- WiFi Indicator	K- Value Display Screen	

5. Assembly Instructions

- Take out the filter.** For initial use, place the air purifier flat on the desktop. Twist to open the filter compartment as shown in the illustration. Take out the filter and remove the filter packaging.

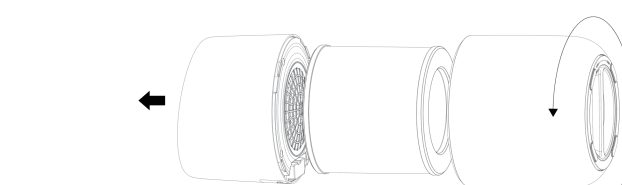

- Install the filter.** Place the filter into the filter compartment (note the installation direction of the filter). Twist to install the filter compartment properly.

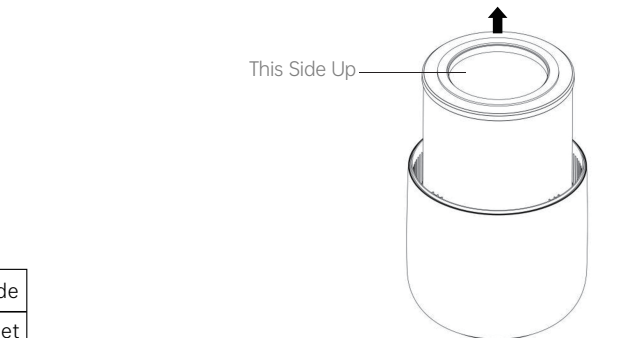

- Place properly.** Place the air purifier on a flat and stable surface. Make sure the air inlet is at least 10cm (3.94in) away from walls or other obstructions.

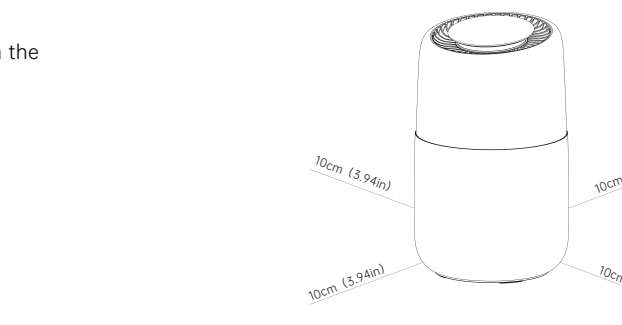

4. Connect to power. Connect the provided power adapter to the power port on the air purifier, then plug it in.

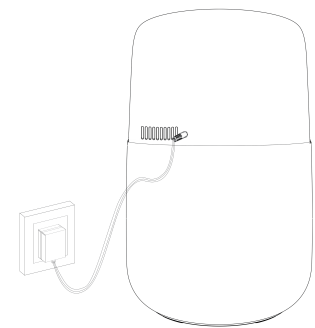

6. Controls & Indicators

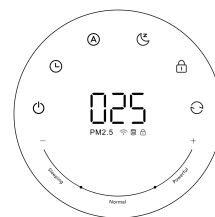

On/Off

1. Press to turn on/off the air purifier. It defaults to the speed used the last time when it was turned off.
2. Network pairing: Press and hold for 3s until starts flashing. The air purifier will reset and enter the state of network pairing (the state of network pairing will last for 10 minutes).

Timer

Press to set a timer (0-12h) to turn off the air purifier.

Speed Level

Slide to adjust the speed (1-10 levels). You can tap the desired position on the speed bar to adjust the speed. The air purifier has a memory function, when you turn on the air purifier, it will run at the mode and speed used the last time it was turned off.

Auto Mode

Press to turn on/off the Auto mode. In Auto mode, the air purifier will automatically adjust the speed level based on the air quality (PM2.5 concentration). When the air quality is moderate or poor, the air purifier will automatically run at a higher speed to quickly and efficiently purify the air. When the air quality is good or very good, the air purifier will automatically run at a lower speed to be quiet and energy-efficient.

Sleep Mode

Press to turn on/off the Sleep mode. In Sleep mode, the air purifier will run at a lower speed. At this time, you can adjust the speed based on your personal tolerance for noise during sleep. If there is no operation for 3s, the screen display will be off (any touch will turn on the screen display). The air purifier can remember the speed setting, and the next time it enters Sleep mode, it will automatically run at the speed used last time.

Child Lock

Long press 2s to turn on/off the child lock. When lights up, the buttons on the screen are locked. When is off, the child lock is turned off.

Filter Reset

When the filter life is < 10%, will light up. To ensure optimal purification performance, please purchase a new filter for replacement. After replacing the filter, press for 3s to reset the filter life to 100%. After reset, will off.

WiFi Indicator

Indicator Status	Statement
Off	WiFi is not connected.
Flashing	Wait to connect to WiFi.
Always on	WiFi is connected.

Filter Replacement Indicator

Indicator Status	Statement
On	Filter life is <10%, indicating the filter needs to be replaced.
Off	Filter life is ≥10%, indicating the filter is functioning normally.

PM2.5 Value Display Screen

1. When you are operating the air purifier, the value display screen will show the current operation information, such as speed (1-10), timer duration (00H, 01H.....12H), etc. At this time, **PM2.5** will not light up.
2. When you are not operating the air purifier, the value display screen will show the PM2.5 value (001-999). At this time, **PM2.5** will light up.

7. App Download Instructions

Once connected to the **Prodigytec app**, the air purifier can interconnect with other devices added to the app. The air purifier supports voice control through Alexa or Google Home.

1. Download the Prodigytec app from App Store (IOS device) or Google Play (Android device). Register your account via email. Open the Prodigytec app, and allow the app to access the location permissions.



2. Turn on the air purifier and press for 3s. Then the air purifier will enter the state of network pairing, and will light up.
3. Turn on BT on your phone, and enter "Home" in the Prodigytec app, and Select "+" -"Add device"- "Home appliance" - "ClearBreathe Smart Air Purifier". Then, follow the on-screen instructions to add the air purifier.

8. Maintenance & Care

Filter cleaning

Use a vacuum cleaner to clean the dust from the fabric pre-filter, the 4-in-1 filter surface and the filter compartment. It is recommended to clean them once a month.

Note:

1. Do not pull hard on the fabric pre-filter to prevent it from falling off.
2. The filters should not be washed with water or in a washing machine.

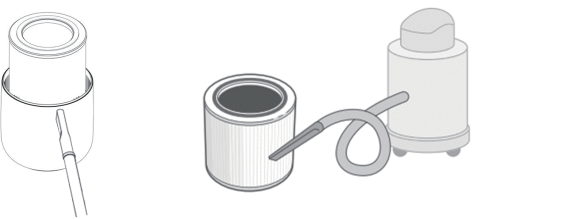

4-in-1 filter replacement

The 4-in-1 filter has a life expectancy of 8-12 months. When the filter life is <10% (remaining life of approximately 1 month), will light up in red to remind the user to replace the filter. Note: The actual filter life may vary depending on the frequency of use of the air purifier in each household, and the actual situation should prevail.



PM2.5 detection port

If the PM2.5 value remains high and does not decrease even after continuous purification, it may be due to dust accumulation caused by long-term use. In this case, you can use a hair dryer (on the cold air setting) and **blow air diagonally** toward the PM2.5 detection port to blow out the dust inside the detection port, so that the PM2.5 sensor can resume normal operation.

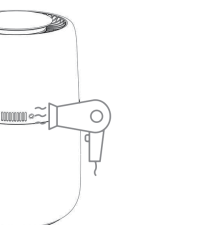

9. Troubleshooting

The air purifier cannot be powered on.

1. Make sure you are using the provided power adapter to power on the air purifier.
2. Make sure the power adapter and the air purifier are connected properly.

Unable to control the air purifier through the control panel.

1. Check whether you turn on the child lock.
2. Check whether your hands are wet, which may affect the touch control.
3. Try to power off the air purifier, and restart it.

PM2.5 cannot be detected or PM2.5 is displayed incorrectly.

1. Check whether the PM2.5 detection port is blocked by any objects.
2. Check whether the PM2.5 detection port has not been cleaned for a long time. You can use an air dryer (cold air) to remove the dust.

Poor air purification effect.

1. Make sure remove the filter packaging.
2. Adjust the air purifier to a higher speed.
3. Clean or replace the filter.

Abnormal noise.

1. Make sure remove the 4-in-1 filter packaging, and the filter is installed properly.
2. Make sure there are no obstructions within 10cm (3.94in) around the air purifier.
3. Make sure there are no foreign objects in the air outlet, air inlet, or filters.

The air purifier cannot connect to the Prodigytec app.

1. Make sure your phone's BT is turned on and the air purifier is not currently connected to another phone.

2. During setting, you need to use a secure 2.4GHz WiFi network and ensure the network is working properly.
3. Make sure the WiFi password you enter is correct, and that there are no spaces at the beginning or end of the password.
4. Test the WiFi password by connecting other electronic devices to the router.
5. If you are manually entering the SSID and password, make sure they are both correct.
6. Try moving the air purifier closer to the router, with your phone as close to the air purifier as possible.
7. Your router may need to be moved higher and away from obstacles.
8. Make sure the air purifier and router are kept away from electrical appliances, such as microwaves, fridges, electronics, to avoid signal interference.
9. If you are using a VPN, make sure to turn it off when setting the air purifier.
10. Disable any portal authentication on your WiFi network. If portal authentication is enabled, the air purifier will not be able to access your WiFi network and the setting will fail.

The air purifier is offline.

1. Make sure the air purifier is plugged in and powered on, and the network condition is good.
2. Try to delete the offline air purifier from the app, and reconfigure the air purifier.
- Note:** Power outages, network disconnections, or changing the WiFi router can all potentially cause the air purifier to go offline.

10. Notice

FCC Statement

This device complies with Part 15 of the FCC Rules. Operation is subject to the following two conditions:
(1) This device may not cause harmful interference, and
(2) This device must accept any interference received, including interference that may cause undesired operation.

Warning: Changes or modification not expressly approved by the party responsible for compliance could void the user's authority to operate the equipment.

Note: This equipment has been tested and found to comply with the limits for a class B digital device, pursuant to Part 15 of the FCC Rules. These limits are designed to provide reasonable protection against harmful interference in a residential installation.

This equipment generates, uses and can radiate radio frequency energy and, if not installed and used in accordance with the instructions, any cause harmful interference will not occur in a particular installation. If this equipment does cause harmful interference to radio or television reception, which can be determined by turning the equipment off and on, the user is encouraged to try to correct the interference by one or more of the following measures:

- (1) Reorient or relocate the receiving antenna.
 - (2) Increase the separation between the equipment and receiver.
 - (3) Connect the equipment into an outlet on a circuit different from that to which the receiver is connected.
 - (4) Consult the dealer or an experienced radio/ TV technician for help.
- To maintain compliance with FCC's RF Exposure guidelines, this equipment should be installed and operated with minimum 20cm distance between the radiator and your body: Use only the supplied antenna.

IC Statement

This device complies with Industry Canada licence-exempt RSS standard(s).
Operation is subject to the following two conditions:
(1) This device may not cause interference, and
(2) This device must accept any interference, including interference that may cause undesired operation of the device.

To maintain compliance with RSS-102 RF Exposure guidelines, this equipment should be installed and operated with minimum 20cm distance between the radiator and your body: Use only the supplied antenna.

Le présent appareil est conforme aux CNR d'Industrie Canada applicables aux appareils radio exempts de licence. L'exploitation est autorisée aux deux conditions suivantes:

- (1) l'appareil ne doit pas produire de brouillage, et
- (2) l'utilisateur de l'appareil doit accepter tout brouillage radioélectrique subi, même si le brouillage est susceptible d'en compromettre le fonctionnement.

Pour être conforme aux lignes directrices d'exposition RF RSS-102, cet équipement doit être installé et exploité à une distance minimale de 20cm entre le radiateur et votre corps: n'utilisez que l'antenne fournie.

11. Warranty

12-month warranty for the air purifier.
60-day money-back guarantee for quality issues.
Note: Damages caused by the disregard of this user manual are not subject to warranty.

12. Contact Us

At Provirtec, we value your experience. If you have any questions about our product, please contact us through our store or app. Our dedicated team will respond promptly to provide you with the support you need. Thank you for choosing Provirtec, and we look forward to serving you.