

tonepie

Q-Clean
Smart cat litter box

User Manual

Contents



User notification & Safe Use Guidelines	02	Litter box Cleaning	12
User notification		One key for replacing litter	
Safe Use Guidelines		Cleaning	
Components and accessories list	03	Description of buttons	13
		and indicator lights	
Use instructions	04-07	Parameters and Specifications	14
Inspect litter box and accessories			
Proper placement of litter box			
Power on & self-check			
Networking settings			
Add cat litter			
Installation and replacement of garbage bags			
Smart Deodorization Spray	08-11		
Main components			
Where use			
How to use			
Function settings			
Cleaning and maintenance			
Attention			
Product parameters			



User notification

1. Thank you for using the Tonepie smart cat litter box. Tonepie is committed to creating a beautiful experience of "carefree pet care and clean life" for you.
2. Before use, please carefully read the manual. Once installed and used, it means that you have carefully read and accepted the following safety instructions.
3. Our company is not responsible for any accidents or losses caused by abnormal operations.
4. The explanation and modification rights of this manual belong to Hefei J&Q Network Technology Co., Ltd.

Safe Use Guidelines

⚠ Failure to comply with the following terms may result in the litter box being unable to function properly or other unexpected losses.

1. Please strictly follow the instructions for installing and using the litter box.
2. Litter box placement requirements: Please place the litter box on a firm and flat ground, do not rely on objects or walls, to avoid affecting the weighing. Please do not place anything on the top of the litter box.
3. Litter box movement requirements: This litter box has four weight sensors at the bottom. Please do not drag when moving it to avoid damage.
4. Cat litter selection: This litter box is suitable for small diameter tofu cat litter, mixed cat litter, bentonite cat litter, and mineral cat litter, which can be clumped. Not suitable for tofu and mixed cat litter with diameter > 3mm or length > 15mm, as it can cause waste of cat litter. Do not use non clumping cat litter.
5. Kittens weighing less than 1kg and nursing cats are strictly prohibited from using the Auto cleaning & Timing cleaning.
6. The host (base) of this litter box is strictly prohibited from soaking in water. If accidentally getting wet during the cleaning process, please wipe it dry to avoid damaging electrical components.
7. Please use the original power adapter to avoid litter box damage or safety hazards.
8. Please use this litter box indoors and avoid high temperatures, humidity, and direct sunlight.
9. Please repair under the guidance of professional personnel to avoid product damage or other accidents.
10. If you face any problem about litter box, please contact customer service.

Components and accessories list

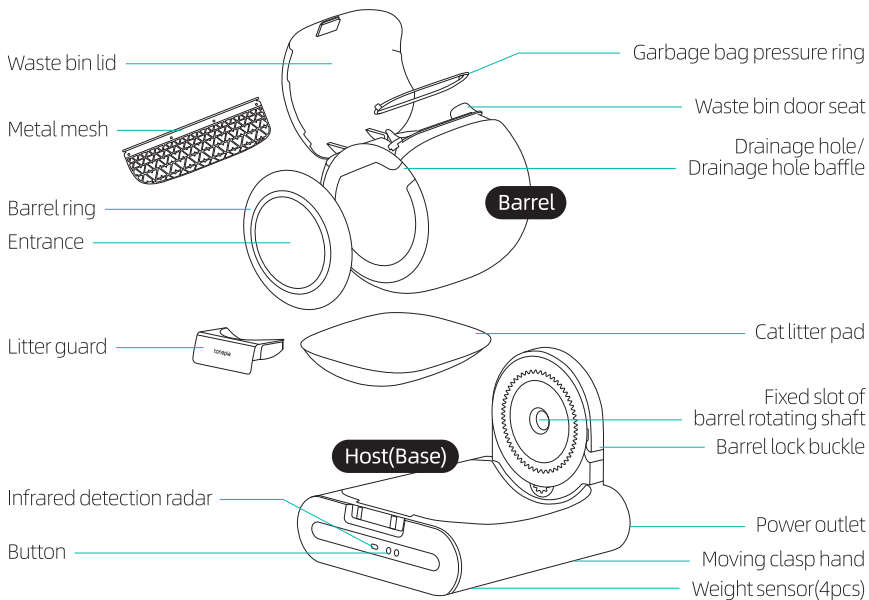

Accessories



Power adapter



Garbage bag
(one roll)



User manual



Intelligent
spray deodorizer



Purified liquid

Use instructions



Inspect litter box and accessories

1. Take out the litter box, remove all fixing tapes, open the waste bin lid, and check if the litter box and accessories are complete (see product list for details).
2. Check whether the litter box itself is complete, whether the barrel is installed correctly, and whether the barrel lock buckle and the waste bin lid are properly closed.

Proper placement of litter box

1. Ensure that the litter box is placed on a firm and flat ground, without anything at the bottom.
2. Ensure that there are no walls or objects around the litter box, and nothing are placed on the top.
3. Ensure that the litter box is close to the WiFi signal source and away from other interfering household appliances.

Power on & self-check

1. After the litter box is powered on and makes a beep sound, white Clean light flashes, and the litter box starts self checking (the duration is between 30 seconds and 180 seconds depending on the position of the barrel).
2. After self check is completed, the litter box defaults to Auto cleaning mode, with white Clean light is on and blue WiFi light is flashing. Users need to wait for the self check to complete before proceeding to the next step.
3. If the self check is not successful and the WiFi light is not on, please check if the barrel is installed correctly. After powering on again, perform the self check again. If it is not successful, please contact customer service.

Use instructions



Networking settings

1. Scan the code or enter the App store to download and install "Smart Life".
2. Open the App to register and log in. The homepage will automatically search for the Q-clean smart cat litter box, select Add, and follow the instructions for online operation.
3. The phone needs to be connected to 2.4GHz WiFi, and currently does not support WiFi in the 5GHz frequency band, hotels, airports, and other areas that require special authentication. And open the Bluetooth and Location on the phone, Android phones also need to open GPS.
4. If the litter box cannot be automatically searched, you need to manually add. Press the WiFi button  for 5 seconds, and a long beep will sound. The blue WiFi light will change from slow flashing to fast flashing. Release the button and follow the App's instructions to start connecting.
5. After successful networking, the blue WiFi light will remain on.
6. If there is a network failure, please check if the WiFi frequency band, password, etc. are correct, the WiFi signal strength, and try to reconnect. If there are multiple failures, please contact customer service.



Download The App

Use instructions



Add cat litter

1. This litter box can use tofu litter, mixed litter, bentonite litter, and mineral litter. Please choose the suitable mesh according to the type of cat litter used to ensure a better user experience.



Standard mesh



Mesh for mineral litter
(optional)

2. Please connect to the App and follow the prompts to set the litter type and other information to ensure a better user experience.

3. Add cat litter from the entrance of the barrel, and do not exceed the Max line to avoid waste of cat litter.

4. After adding cat litter, please press the Cleaning button  for 2 seconds to level the cat litter.

5. In daily use, please add sufficient cat litter timely to ensure a good user experience.

Use instructions



Installation and replacement of garbage bags

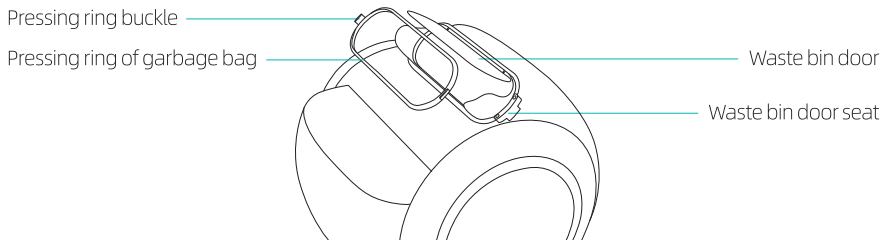

1. If you need to replace the used garbage bag, please press the WiFi button  for 2 seconds to adjust the waste bin to the bag changing angle and open the waste bin. The time for bag changing angle is 60 seconds. After 60 seconds, the barrel will automatically return to the original position. If the installation of the new garbage bag is not completed within 60 seconds, it can be operated again.
2. Hold down the buckles on both sides of the garbage bag pressure ring, and together with the pressure ring, remove the garbage bag that needs to be replaced. **1**
3. Put the new garbage bag into the pressure ring according to the direction shown in the diagram (please note that the pressure ring buckle is facing towards the tail of the garbage bag). **2**
4. Fold the garbage bag outward and wrap it around the entire pressure ring. **3**
5. Reinstall the pressure ring that has been fitted with the garbage bag back onto the waste bin door seat, ensuring that all two buckles are installed in place.
6. After installation, confirm that the waste bin door is not obstructed by the garbage bag and can open and close normally. Organize the back of the garbage bag and close the waste bin lid.

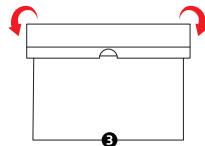
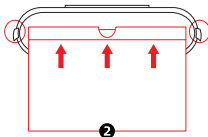
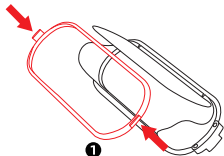

Smart Deodorization Spray



Main components

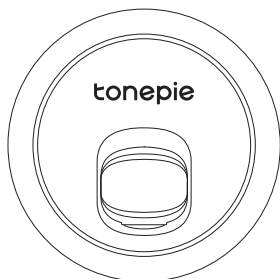

Front

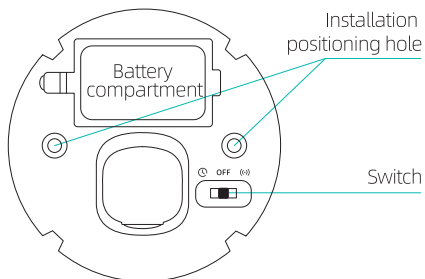

Back

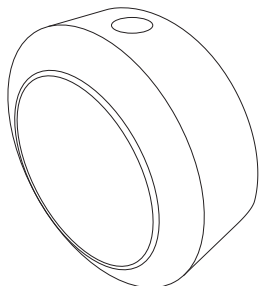

Transparent anti-dirt cover

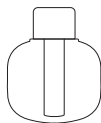

Special purified liquid

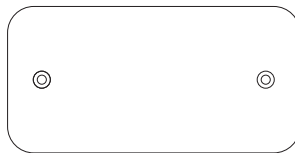

Back glue of installing hook

Smart Deodorization Spray



Where use

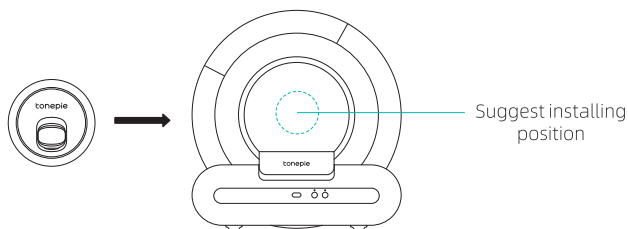

1. Use in smart cat litter box: This spray deodorizer can be installed at the center of the back wall of the barrel of various of drum type smart cat litter boxes (it is recommended to use Auto mode for the best effect).
2. This spray deodorizer can also be installed nearby in traditional cat litter boxes as a deodorizing and sterilizing device (Timing mode is required).
3. Others: This spray deodorizer can be installed in places such as bathrooms, kitchens, shoe cabinets, etc., to have a sterilizing and deodorizing effect (Timing mode is required).

How to use

1. Open the packaging, please check the appearance and accessories of the spray deodorizer.
2. Open the back cover of the battery compartment, insert three No. 7 batteries, and close the back cover.
3. Take a bottle of purified liquid, unscrew the bottle cap, and screw the purified liquid bottle with the cotton swab installed into the spray deodorizer.
4. Please ensure that the installation surface of the spray deodorizer is dry and clean. Tear off the protective film on the back glue of installing hook and stick it tightly to the desired installation position.
5. According to the use places, turn the switch on the back of the spray deodorizer from OFF to Timing mode or Auto mode.
6. Put the anti-dirt cover on the front of the spray deodorizer, and ensure that the spray hole of the anti-dirt cover coincides with the spray hole of the spray deodorizer without blocking.
7. Align the installation positioning hole on the back of the spray deodorizer with the hook and install it in place.

Smart Deodorization Spray



Function settings

1. When the intelligent spray deodorizer is installed in the drum type smart cat litter box, the switch on the back of the spray deodorizer can be turned to the right to the Auto working mode. In this mode, the spray deodorizer will automatically spray along with the rotation of barrel, and conduct a 4-second spray before and after cleaning.



2. When the intelligent spray deodorizer is installed in a fixed position, such as on the wall, the switch can be turned to the left to set the Timing mode. In this mode, the spray deodorizer will conduct a spray lasting for 6 seconds every half an hour.



3. When not using this spray deodorizer, please turn the switch to OFF and remove the battery and take out the purified liquid bottle.

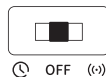

Cleaning and maintenance

1. When using this spray deodorizer in a smart cat litter box, please ensure that the transparent anti-dirt cover is installed well before use.
2. The body of the spray deodorizer is strictly prohibited from being washed with water. The surface can be wiped with a damp cloth or non-alcoholic wipes.
3. Use a cotton swab dipped in alcohol to focus on cleaning the spray hole of the spray deodorizer to prevent blockage.
4. The transparent anti-dirt cover can be washed with water.
5. Please use qualified batteries and replace them timely to prevent battery leakage and damage the spray deodorizer.
6. The purified liquid is a transparent bottle body, and the remaining amount can be observed through the purified liquid level. Please replace the original purified liquid timely.

Smart Deodorization Spray



Attention

1. Please ensure that the original purified liquid is used for this spray deodorizer to obtain better spray and purification sterilization effect.
2. Purified liquid can only be used for spray normally when a cotton swab is installed. The cotton swab is a disposable product.
3. Using spray deodorizer without purified liquid can cause damage to the spray deodorizer.
4. When the electricity is insufficient, the spray amount will be reduced.
5. Please keep the purified liquid out of reach of children and pets, and prevent accidental ingestion.

Product parameters

Product name: Smart Deodorization Spray

Product model: TP-JW-PW23

Product material: ABS

Product size: 110 (W) × 46 (D) × 110 (H) mm

Rated voltage: 4.5VDC

Executive standard: GB/T 26572-2011

Litter box Cleaning



One key for replacing litter

1. Before emptying the litter, please replace a new garbage bag to ensure there is enough space.
2. Press the Clean button  for 5 seconds, and after a long beep, the red Clean light will flash, and the litter box will start emptying litter. Click the Clean button  again can stop.
3. After replacing litter is completed, open the waste bin lid, remove the garbage bag.

Cleaning

1. After emptying the waste bin, disconnect the power, remove the litter guard, open the barrel lock buckle on the base, and take out the barrel.
2. According to the label on the barrel, rotate the barrel ring, unlock and remove the barrel ring, and remove the drain hole baffle. Then remove the intelligent spray deodorizer, metal mesh and cat litter pad.
3. There are electrical components in the base and the intelligent spray deodorizer. It is strictly prohibited to wash them with water, and they can be wiped with a wet cloth.
4. The whole barrel can be washed with water. After cleaning, empty the water in the barrel, dry/wipe all components, and install them in turn, cat litter pad, metal mesh, intelligent spray deodorizer, drain hole baffle, and barrel ring.
5. Install the barrel on the base, lock the barrel lock buckle, install the litter guard, connect the power, wait for the self check, add cat litter, and start using.
6. Users can clean the litter box according to the specific usage habits. It is recommended to replace the garbage bag every 3 days in hot weather (one cat as an example), and wash the barrel with water once every 1-3 months.

Description of buttons and indicator lights



Button name	Operate	State	Light	Sound
Clean 	Click/ Click during cleaning	Begin to clean/ Stop cleaning	White Clean light flashing	One beep
	Press for 2s	Leveling litter	White Clean light flashing	Two beeps
	Press for 5s	Replacing litter	Red Clean light flashing	Long sound for 2s
	Click during replacing litter	Stop replacing litter	White Clean light is on	One beep
WiFi 	Press for 2s	Changing bag	White Clean light flashing	Two beeps
	Press for 5s	Networking	Blue WiFi light flashing rapidly	Long sound for 2s
 + 	Press for 2s	Child lock On/ Child lock Off	Clean light is off / White Clean light is on	Two beeps
	Press for 5s	Reset	White Clean light flashing	Long sound for 2s
		Connected	Blue WiFi light is on	\
		Fault alarm	Red Clean light is on	Long sound for 10 seconds, with a 5-minute interval before continuing to sound for 10 seconds until the fault disappears

Parameters and Specifications

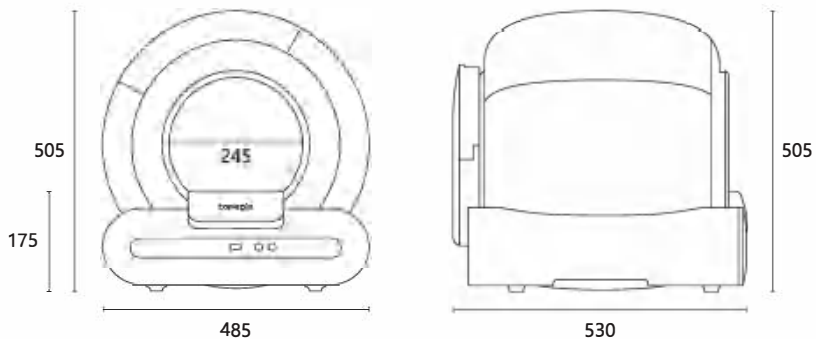

Product Name	Product model	Litter box Dimension	
Q-Clean Smart cat litter box	BDL-TPCBQ-01	485(W)×530(D)×505(H)mm	
Execution standards	Rated voltage	Rated power	Suggested pet type
GB4706.1-2005	DC12V	≤24W	Cat

FCC STATEMENT :

This device complies with Part 15 of the FCC Rules. Operation is subject to the following two conditions:

- (1) This device may not cause harmful interference, and
- (2) This device must accept any interference received, including interference that may cause undesired operation.

Warning: Changes or modifications not expressly approved by the party responsible for compliance could void the user's authority to operate the equipment.

NOTE: This equipment has been tested and found to comply with the limits for a Class B digital device, pursuant to Part 15 of the FCC Rules. These limits are designed to provide reasonable protection against harmful interference in a residential installation. This equipment generates uses and can radiate radio frequency energy and, if not installed and used in accordance with the instructions, may cause harmful interference to radio communications. However, there is no guarantee that interference will not occur in a particular installation. If this equipment does cause harmful interference to radio or television reception, which can be determined by turning the equipment off and on, the user is encouraged to try to correct the interference by one or more of the following measures:

- Reorient or relocate the receiving antenna.

- Increase the separation between the equipment and receiver.

- Connect the equipment into an outlet on a circuit different from that to which the receiver is connected.

- Consult the dealer or an experienced radio/TV technician for help.

FCC Radiation Exposure Statement:

This equipment complies with FCC radiation exposure limits set forth for an uncontrolled environment. This equipment should be installed and operated with minimum distance 20cm between the radiator & your body.