

Antenna Specification

Specifications Summary

ITEM	SPEC.
Model Name	PCB Antenna
Frequency	2400-2500 MHz
MAX. GAIN	1.06 dBi
Polarization	Horizontal
Azimuth Beam Pattern	Omni-directional
Impedance	50 Ω

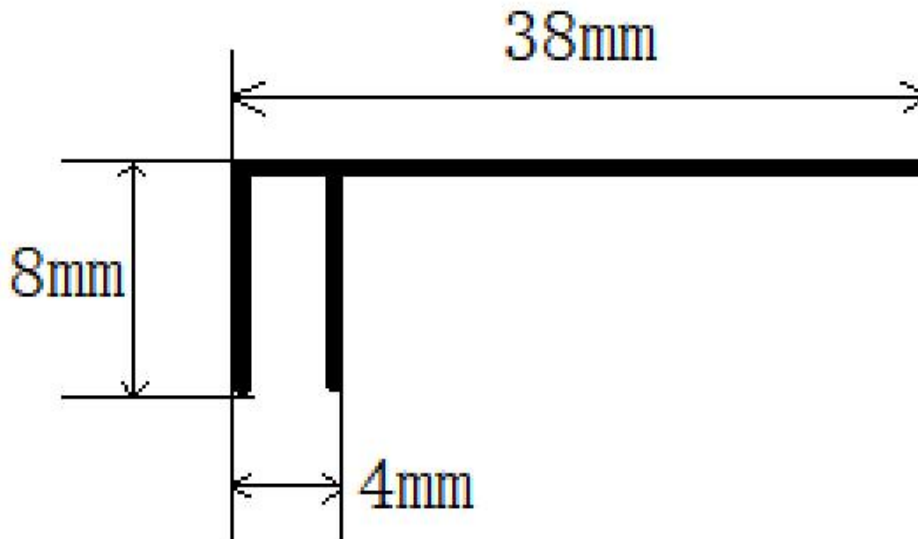

Manufacturer	Biboting Trading (Shanghai) Co., Ltd
Address	No.15, Ground Floor, No.111 Xingshan Road, Putuo District, Shanghai
Test company	ADVANCED CERAMIC X CORP.
Test Address	16 Tzu Chiang Road, Hsinchu Industrial District Hsinchu Hsien 303, Taiwan
Test Date	2023-08-10
Test Instrument	vector network analyzer - R&S ZVB20

1. Main antenna : 2400MHz

1.1 Horizontal

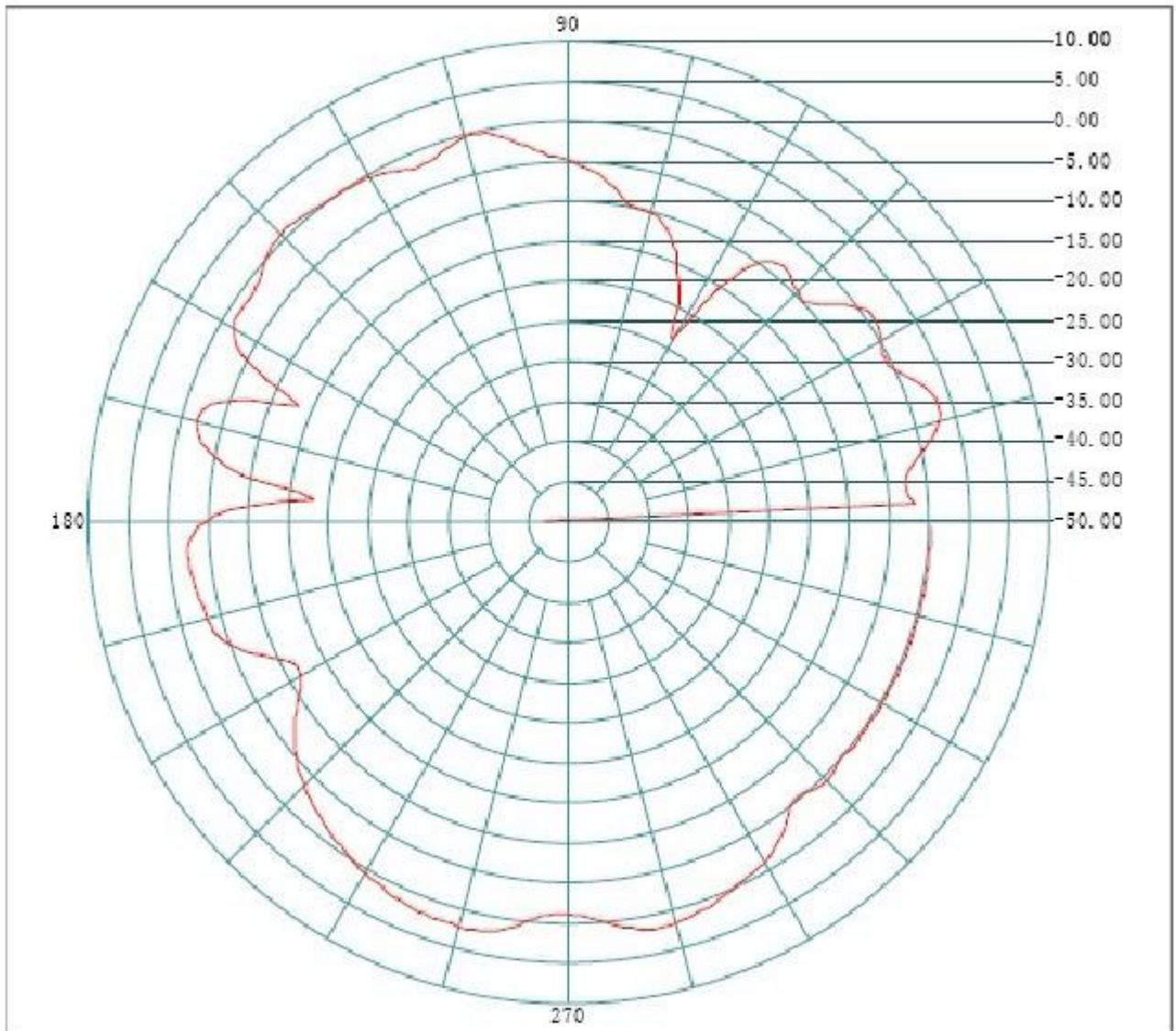

Frequency(MHZ): **2441**

Antenna Polarity: **Horizontal**

Maximum Value(dBi): **1.06**

Average Gain(dBi) : **-3.32**

Minimum Gain(dBi): **-53.04**

1.2 Vertical

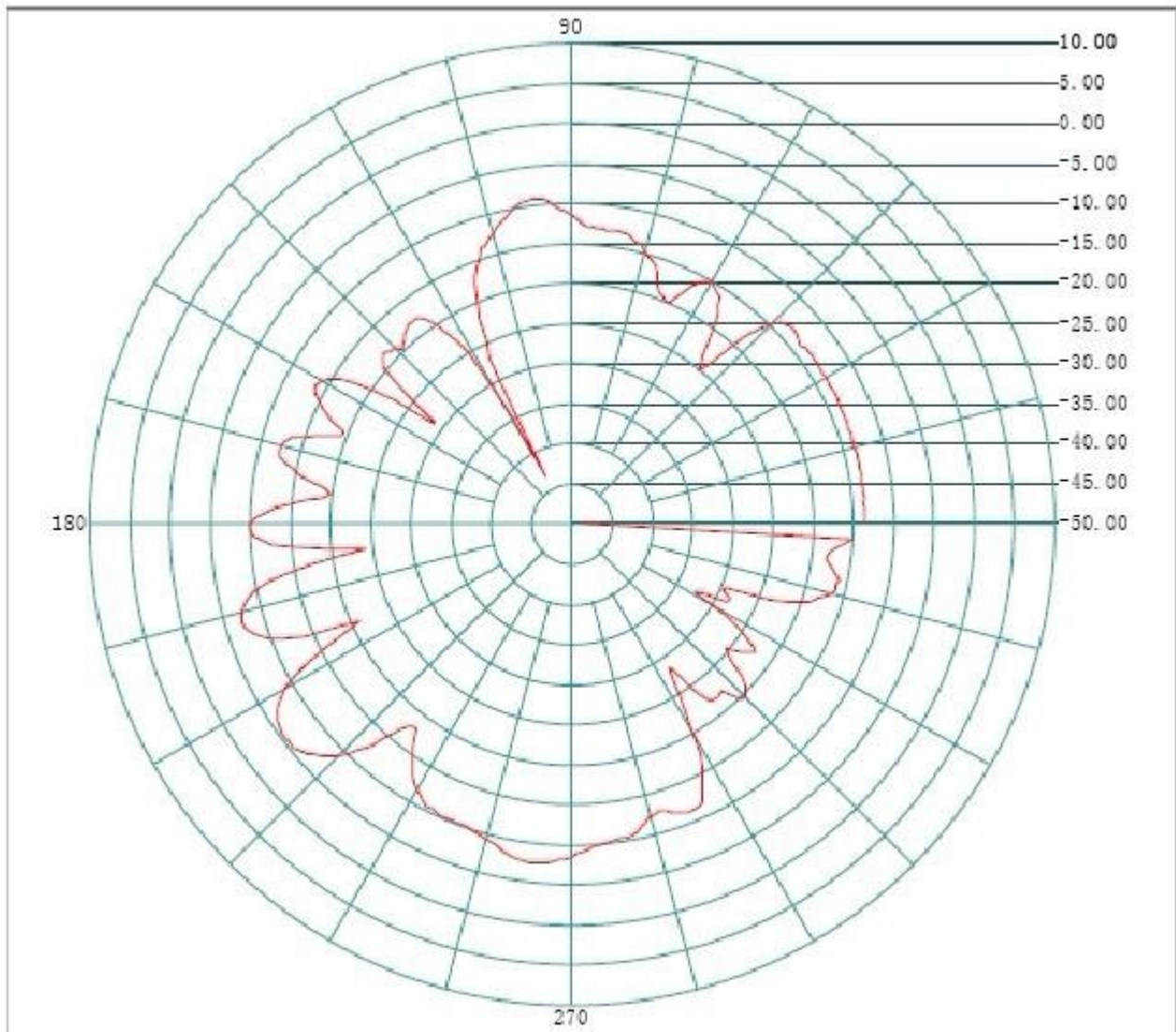

Frequency(MHZ): **2441**

Antenna Polarity: **Vertical**

Maximum Value(dBi): **-4.01**

Average Gain(dBi) : **-6.64**

Minimum Gain(dBi): **-48.4**

2. Main antenna : 2450MHz

2.1 Horizontal

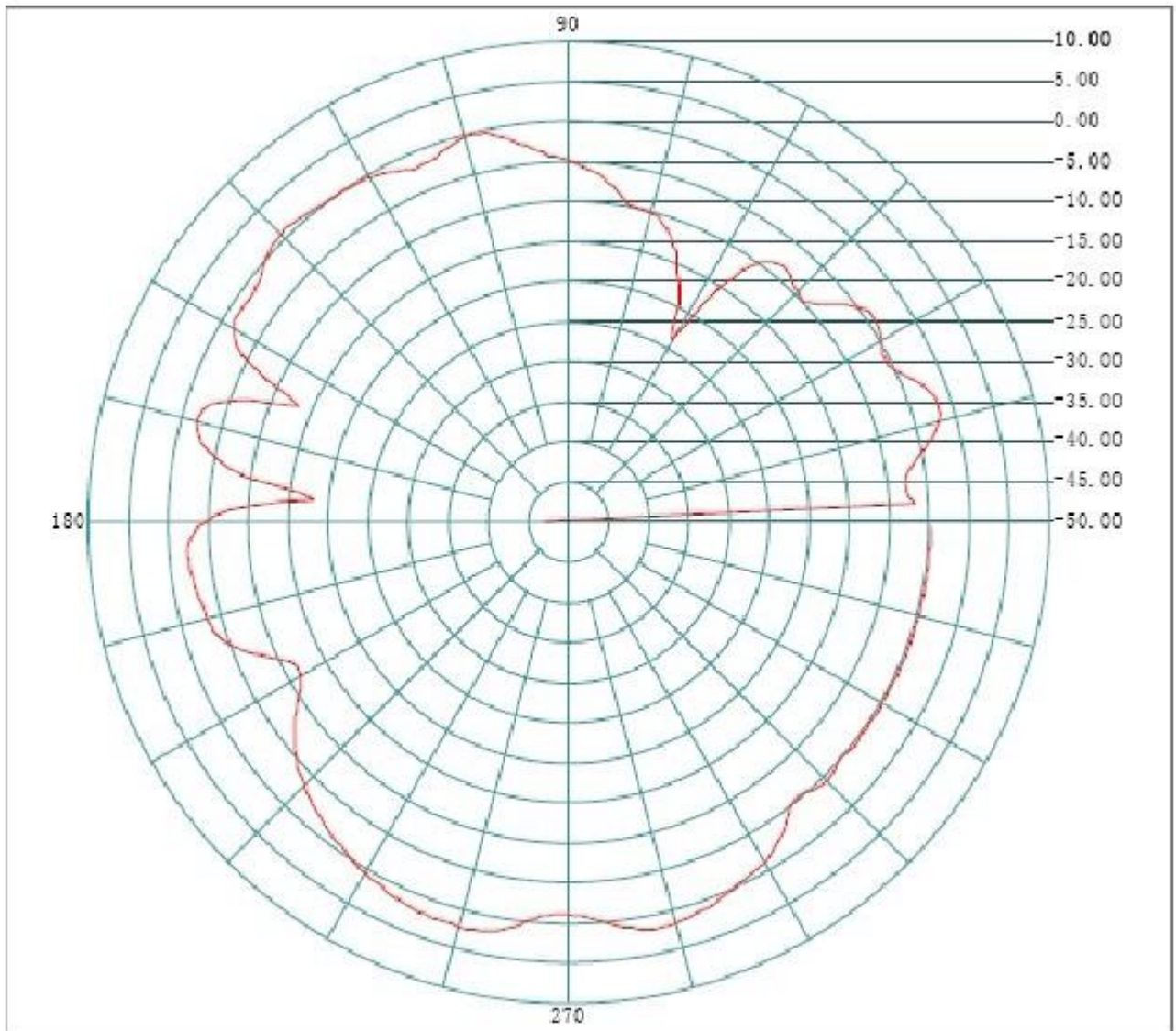

Frequency(MHZ): **2441**

Antenna Polarity: **Horizontal**

Maximum Value(dBi): **0.19**

Average Gain(dBi) : **-4.46**

Minimum Gain(dBi): **-55.84**

2.2 Vertical

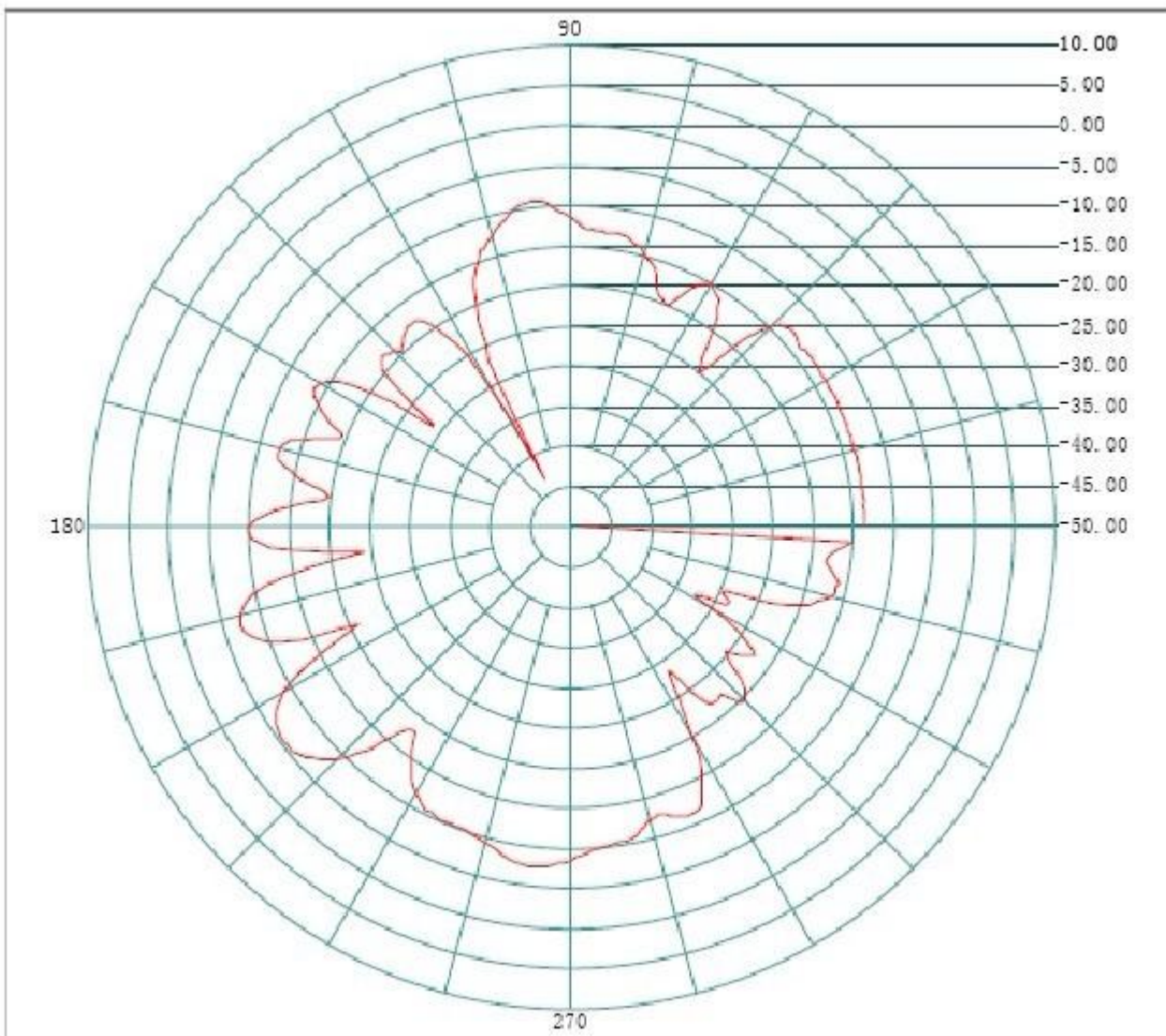

Frequency(MHZ): **2441**

Antenna Polarity: **Vertical**

Maximum Value(dBi): **-5.14**

Average Gain(dBi) : **-7.64**

Minimum Gain(dBi): **-46.8**

3. Main antenna : 2500MHz

3.1 Horizontal

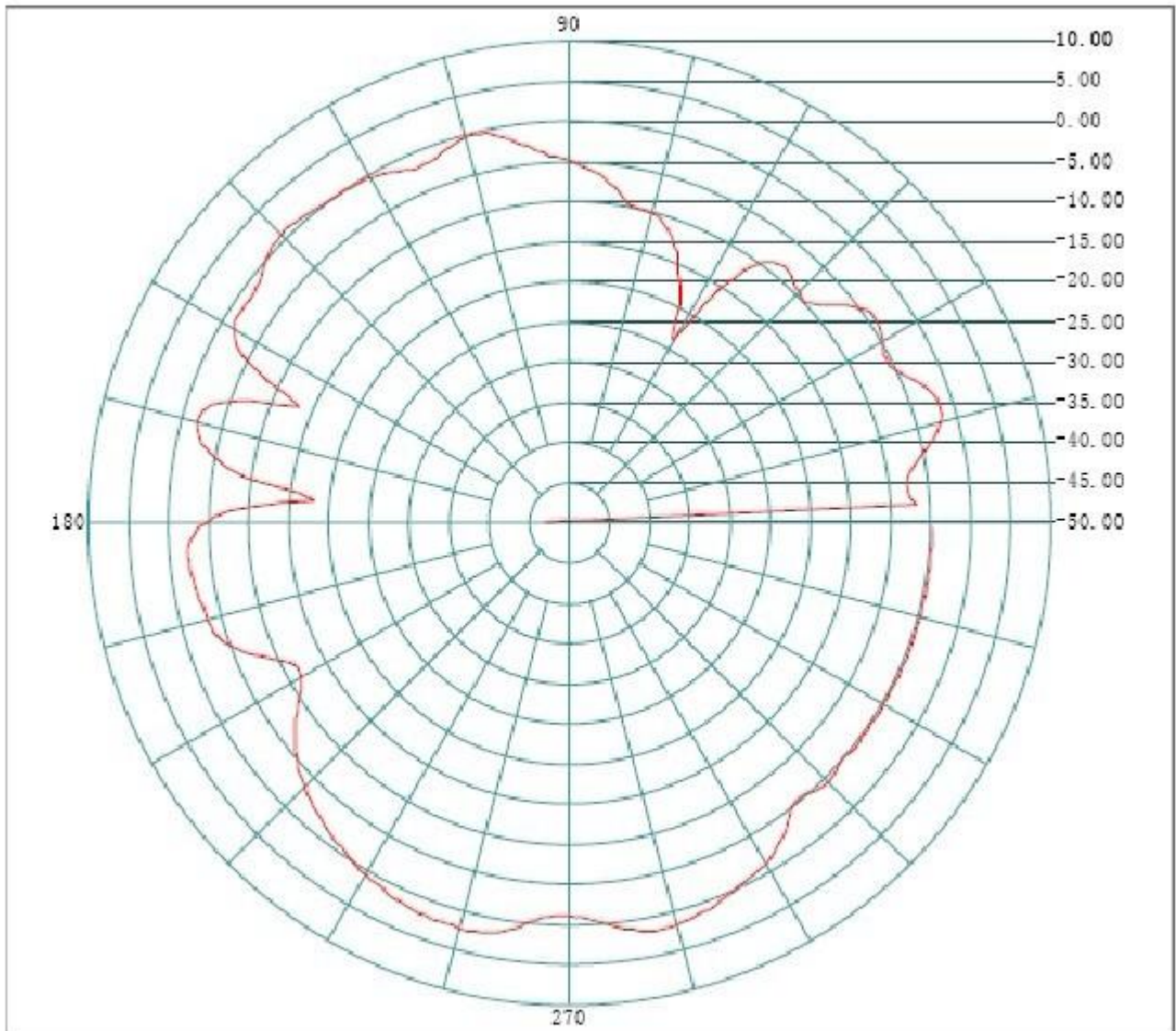

Frequency(MHZ): **2441**

Antenna Polarity: **Horizontal**

Maximum Value(dBi): **0.26**

Average Gain(dBi) : **-3.44**

Minimum Gain(dBi): **-54.71**

3.2 Vertical

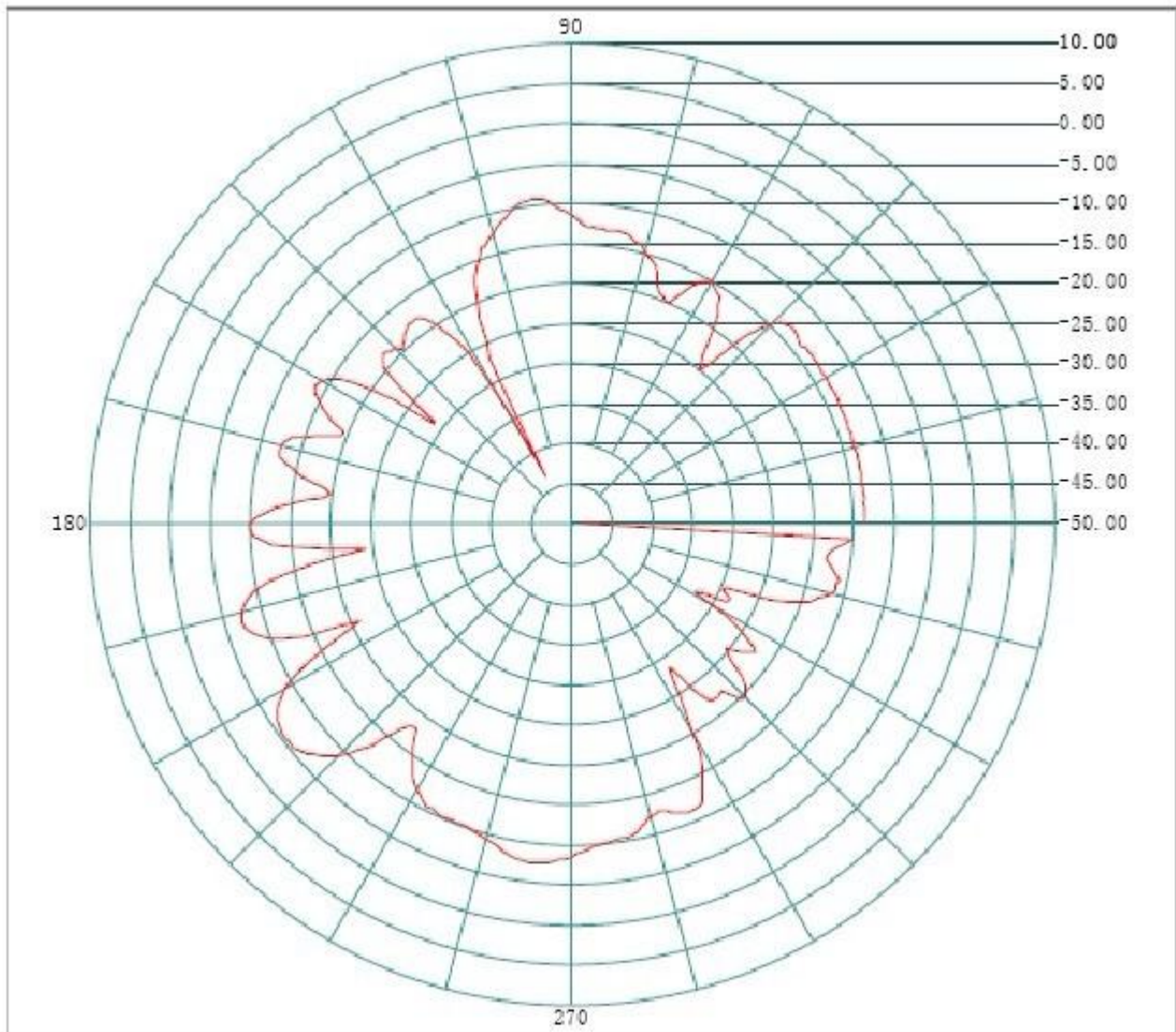

Frequency(MHZ): **2441**

Antenna Polarity: **Vertical**

Maximum Value(dBi): **-4.38**

Average Gain(dBi) : **-6.85**

Minimum Gain(dBi): **-45.82**