

1. Features

- Designed for 2.4GHz applications: BT / BLE, Wi-Fi[®] (802.11a/b/g/n), ZigBee[®].
- Low profile design
- High efficiency
- Lightweight
- Intended for SMD mounting
- Supplied in tape and reel

2. Description

Fusca is intended for use with all 2.4 GHz applications. The antenna uses a ground plane in order to radiate efficiently, but this ground plane must not extend underneath the antenna itself. Ideal for small wearables.

3. Applications

- Wearables
- Medical devices
- Sensors

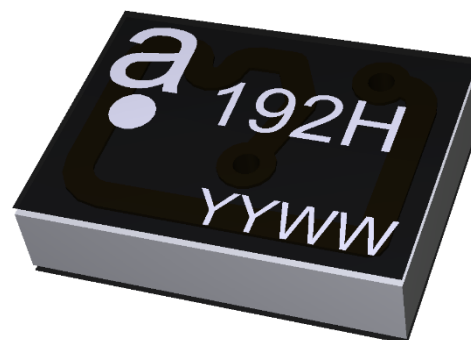

4. Part Number

Fusca: A10192H

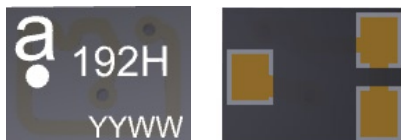

5. General Data

Product name	Fusca
Part Number	A10192H
Frequency	2.4 – 2.5GHz
Polarization	Linear
Operating temperature	-40°C to140°C
Environmental condition test	ISO 16750-4 5.1.1.1/5.1.2.1/5.3.2
Impedance with matching	50 Ω
Weight	<0.03g
Antenna type	SMD
Dimensions	4 x 3 x 1.1 (mm)

6. RF Characteristics

	2.4 – 2.5 GHz
Peak gain	0.8dBi
Average gain (Linear)	-1.9dBi
Average efficiency	65%
Maximum return loss	<-10dB
Maximum VSWR	2:1

All data measured on Antenna's evaluation PCB
Part No. A10192H-EVB-1

7. RF Performance

7.1 Return Loss

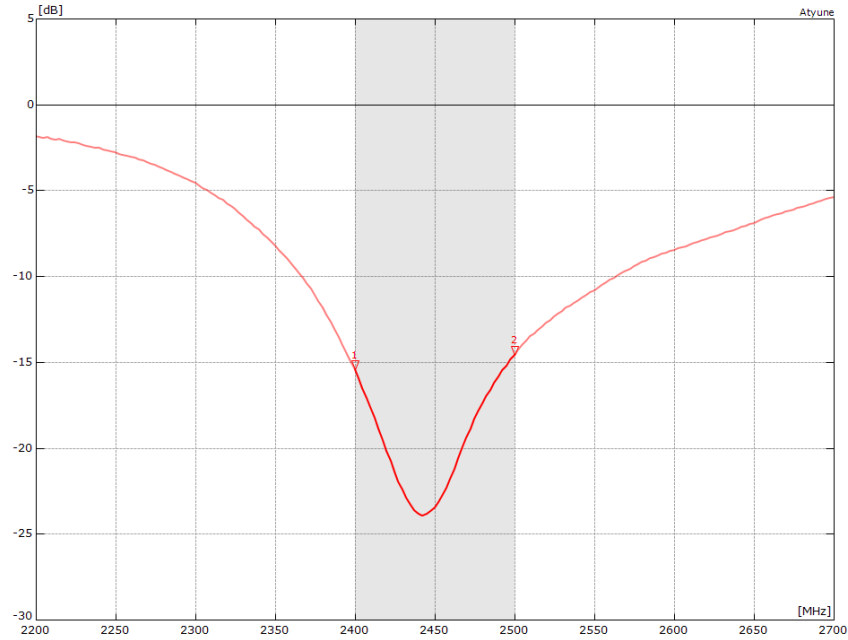

7.2 VSWR

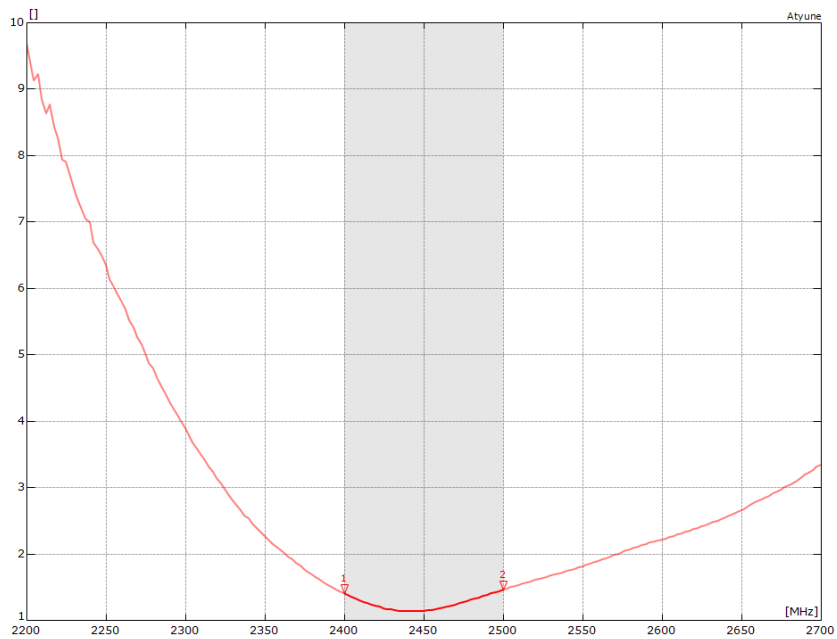

7.3 Antenna pattern

7.3.1 2400 MHz – 2500 MHz

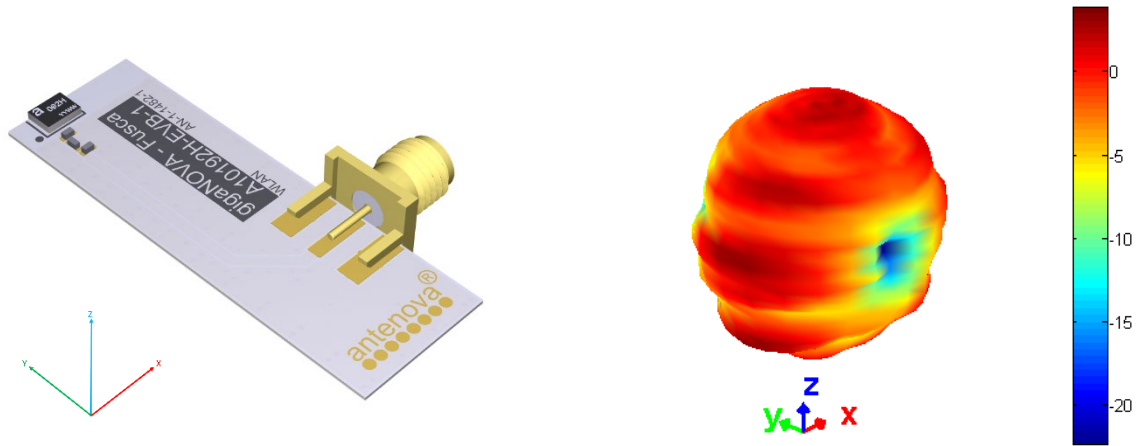

3D pattern at 2450 MHz

Drag to rotate pattern and PCB by using Adobe Reader
(Click to Activate)

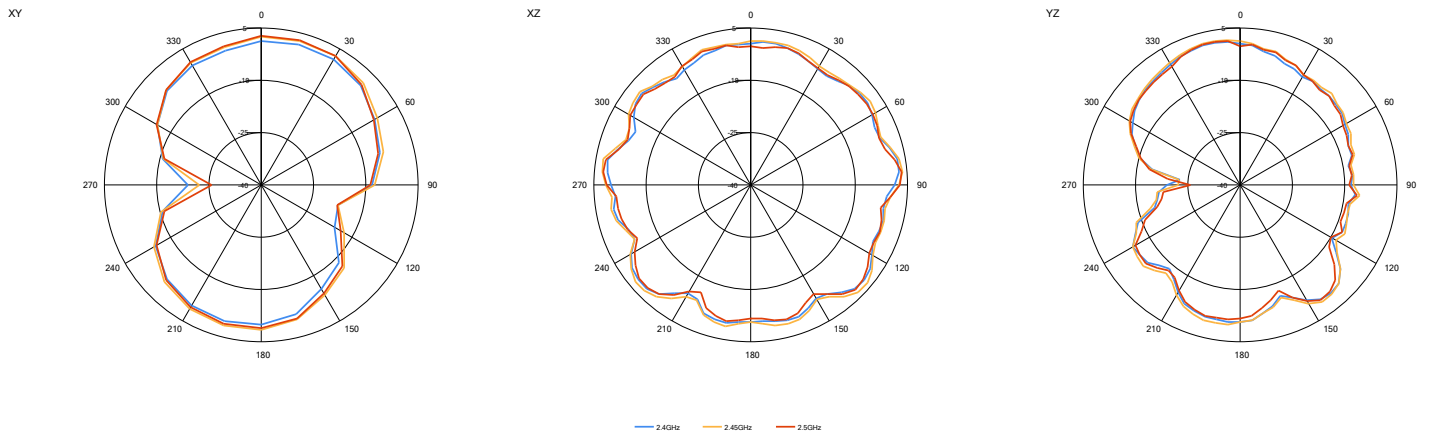

8. Antenna Dimensions

Fusca: A10192H

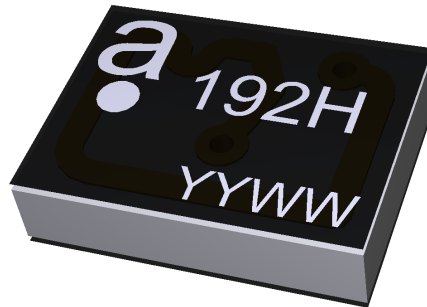

Top side



Bottom Side

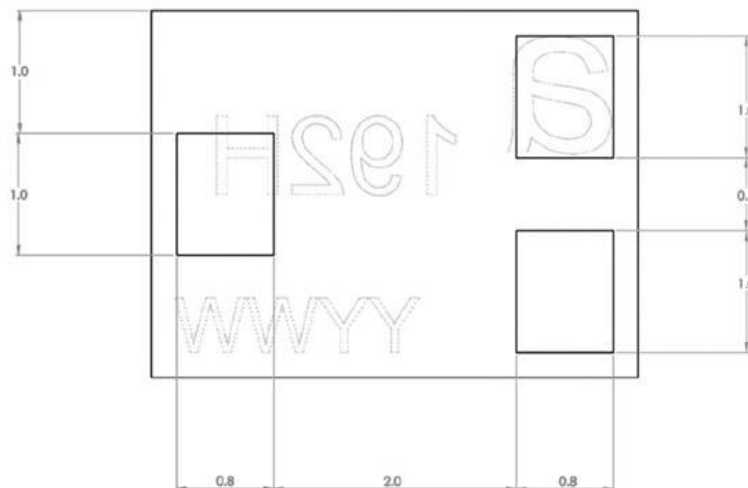

3 solder pads (1.0 x 0.8 mm)

All Dimensions in (mm)

Antennas for Wireless Applications

9. Schematic symbol and Pin definition

The circuit symbol for the antenna is shown below. The antenna has 5 pins with only two as functional. All other pins are for mechanical strength.

Pin	Description
1,2	Feed
3	Not used (Mechanical only)

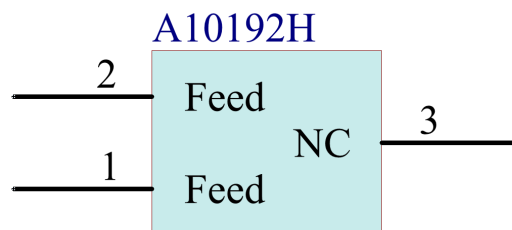

10. Antenna footprint

The recommended host PCB footprint is below.

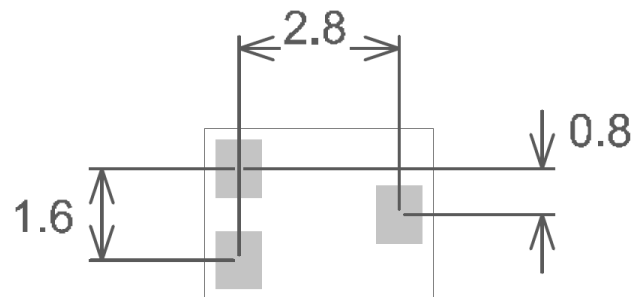

ALL PADS = 1.0 X 0.8 (MM)
ALL DIMENSIONS IN MM

11. Electrical Interface

11.1 Transmission Line

All transmission lines should be designed to have a characteristic impedance of 50Ω.

- The length of the transmission lines should be kept to a minimum
- Any other parts of the RF system like transceivers, power amplifiers, etc, should also be designed to have an impedance of 50 Ω

Once the material for the PCB has been chosen (PCB thickness and dielectric constant), a coplanar transmission line can easily be designed using any of the commercial software packages for transmission line design. For the chosen PCB thickness, copper thickness and substrate dielectric constant, the program will calculate the appropriate transmission line width and gaps on either side of the track, so the characteristic impedance of the co-planar transmission is 50 Ω.

11.2 Matching Circuit

The antenna requires a matching circuit that must be optimized for each product. The matching circuit will require up to 3 components and the following circuit should be designed into the host PCB. Not all components may be required but should be included as a precaution. The matching network must be placed close to the antenna feed to ensure it is more effective in tuning the antenna.

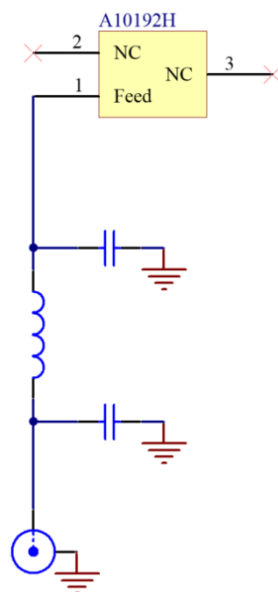

12. Antenna Integration Guide

12.1 Antenna Placement

Antenova strongly recommends placing the antenna at the edge of the board. Maximum antenna performance is achieved by placing the antenna towards one of the corners of the PCB and with the feed point of the antenna as close to same corner of the PCB as possible.

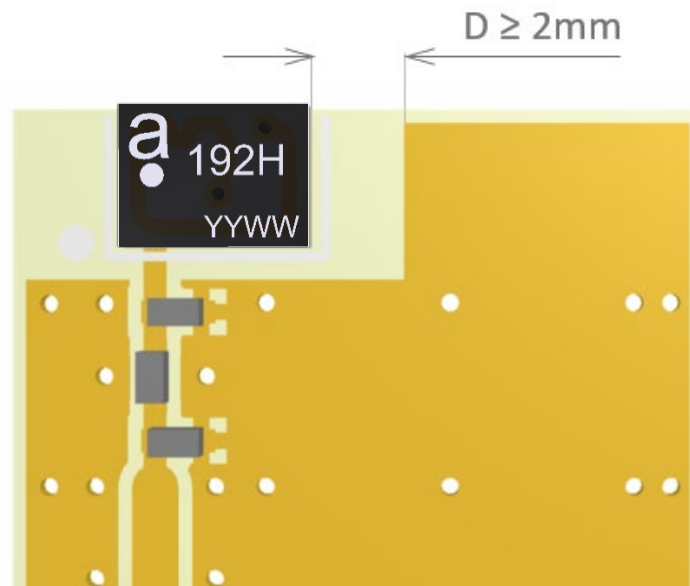

Additional ground and components near the antenna should be at a distance of at least 2 mm. Where possible the antenna should be clear of ground from both sides, although the antenna can work well with a minimum clearance of $D \geq 2$ mm as shown in the drawing above.

13. Reference Board

The reference board has been designed for the purpose of evaluating A10192H and includes an SMA female connector.

A10192H Evaluation Board

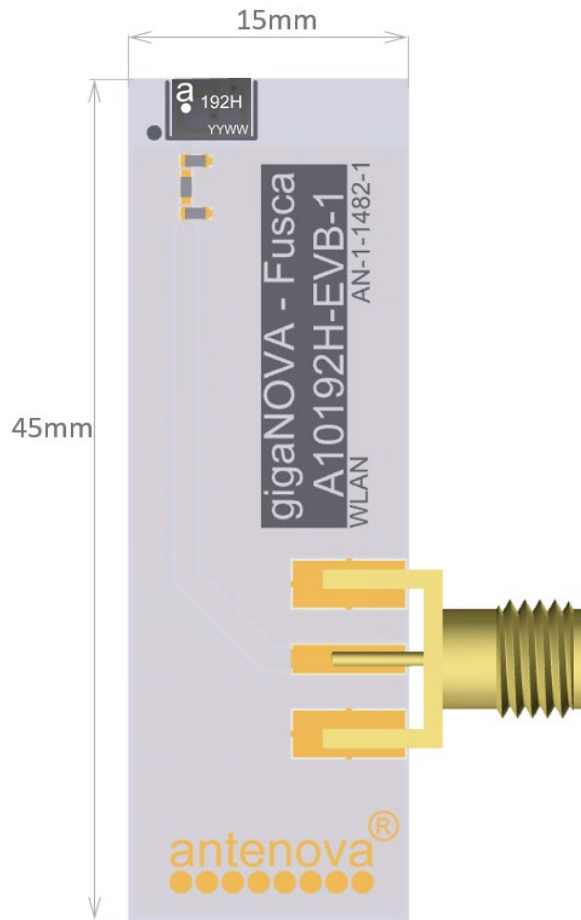

To order a reference board please see www.antenna.com

14. Reference Board Matching Circuit

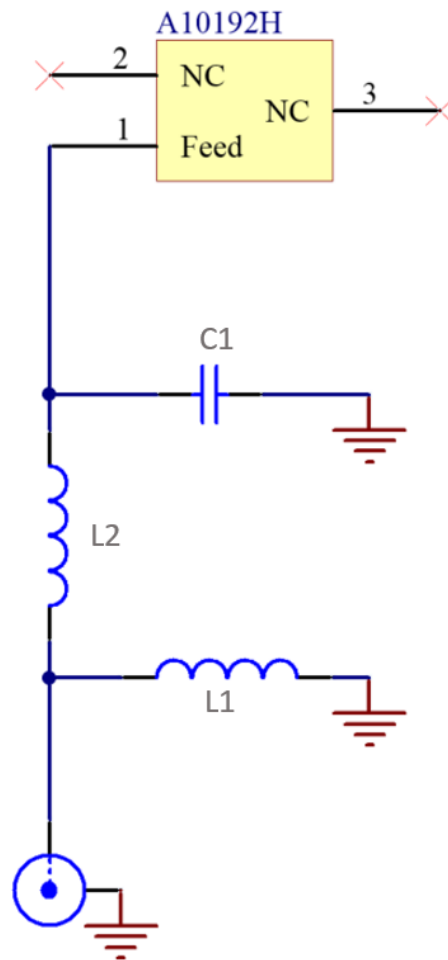

Designator	Type	Value	Description
L1, L2	Inductor	2.2nH	Murata LQG15HN series
C1	Capacitor	Not fitted	Not fitted

15. Comparison S11

The A10192H is a direct replacement for the A10192 original parts. The chart shown below is a comparison between the two antennas on the same evaluation PCB.

15.1 Return Loss

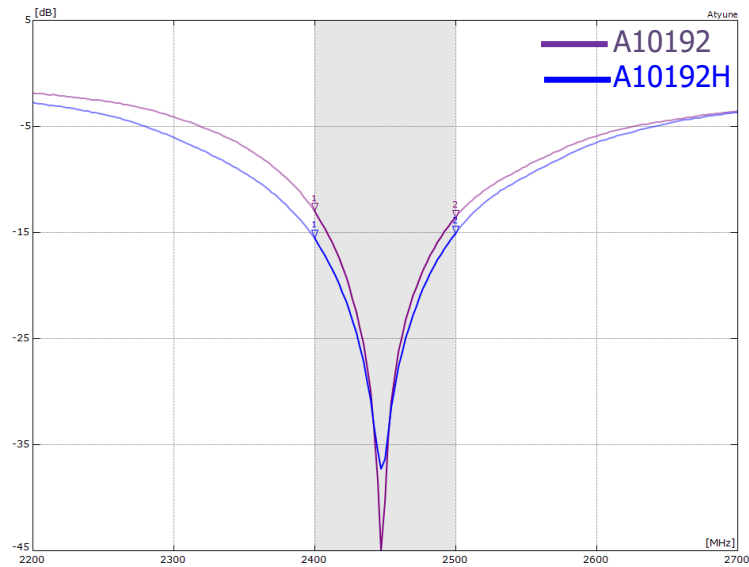

15.2 VSWR

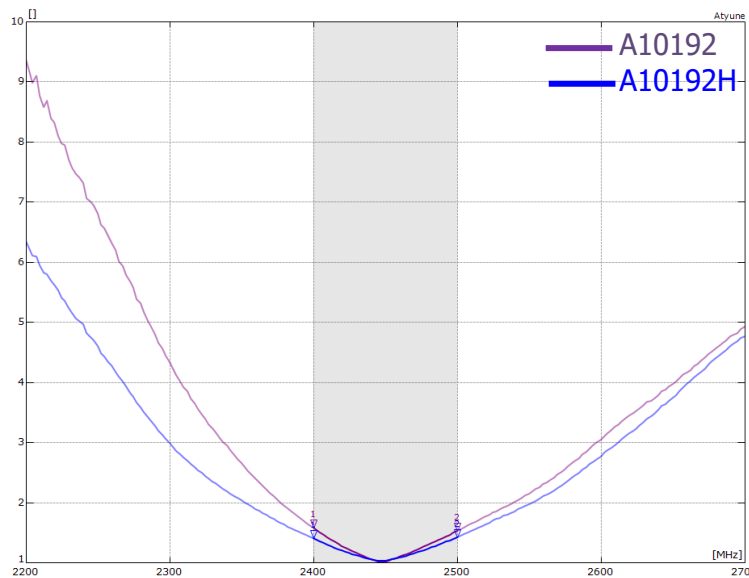

15.3 Pattern Comparison

The A10192H is a direct replacement for the A10192 original part. The below is a comparison of each on the same evaluation PCB shown in a polar format.

— A10192H
— A10192

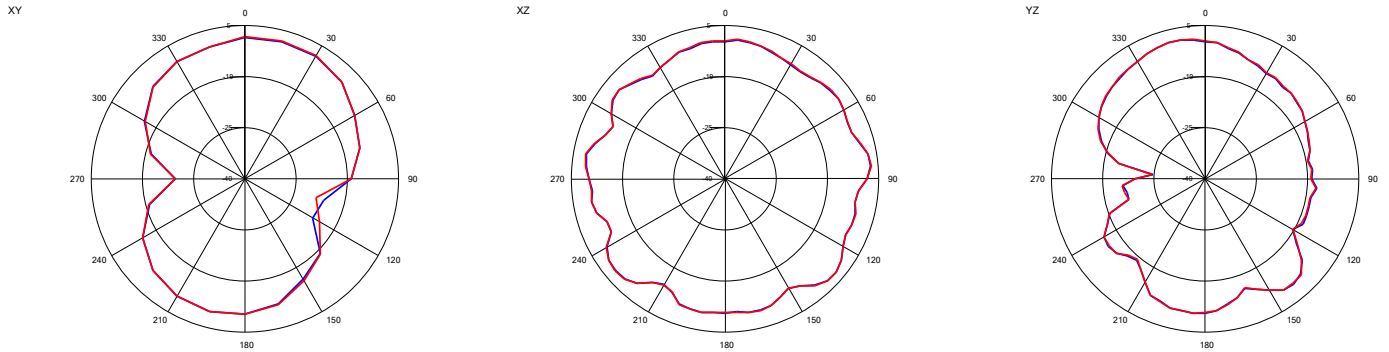

16. Soldering

This antenna is suitable for lead free soldering.

The reflow profile should be adjusted to suit the device, oven, and solder paste, while observing the following conditions:

- The maximum temperature should not exceed 240 °C
- However, for lead free soldering, a maximum temperature of 255 °C for no more than 20 seconds is permitted.
- The antenna should not be exposed to temperatures exceeding 120 °C more than 3 times during the soldering process.

17. Hazardous Material Regulation Conformance

The antenna has been tested to conform to RoHS requirements. A certificate of conformance is available from Antenova M2M's website.

18. Packaging

18.1 Optimal Storage Conditions

Temperature	-10°C to 40°C
Humidity	Less than 75% RH
Shelf life	24 Months
Storage place	Away from corrosive gas and direct sunlight
Packaging	Reels should be stored in unopened sealed manufacturer's plastic packaging.

Note: Storage of open reels of antennas is not recommended due to possible oxidization of pads on antennas. If short term storage is necessary, then it is highly recommended that the bag containing the antenna reel is re-sealed and stored in like storage conditions as in above table.

18.2 Tape Characteristics

Fusca [Part Number: A10192H]

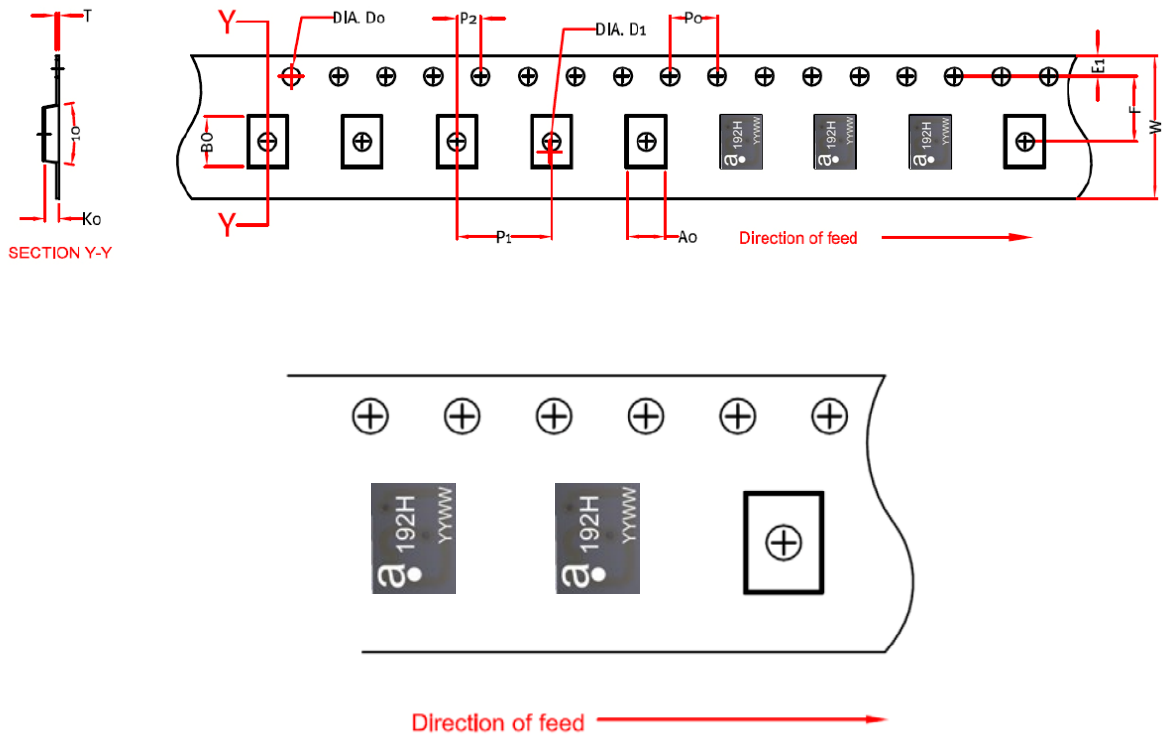

18.3 Reel Dimensions

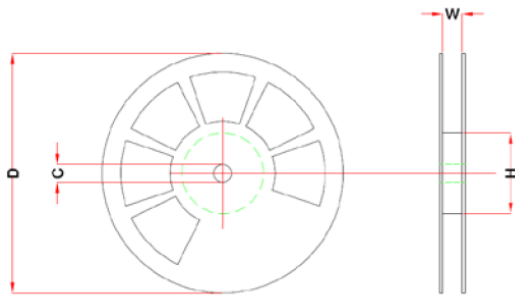

Width	Reel Diameter	Hub Diameter	Shaft Diameter
14 mm	178 mm	60 mm	13.2 mm

18.4 Box Dimensions

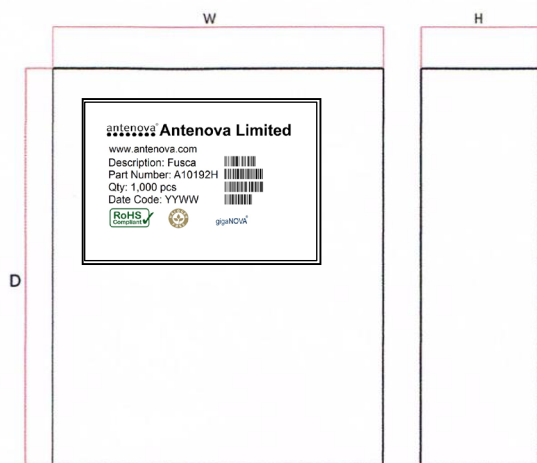

Width W	Breadth B	Thickness H
195 mm	195 mm	37 mm

18.5 Bag Properties

Reels are supplied in protective plastic packaging.

18.6 Reel Label Information

antenova® **Antenova Limited**

www.antenova.com

Description: Fusca
Part Number: A10192H
Qty: 1,000 pcs
Date Code: YYWW



Quality statements

Antenova's products conform to REACH and RoHS legislation. For our statements regarding these and other quality standards, please see www.antenova.com.



Antenna design, integration and test resources

Product designers – the details contained in this datasheet will help you to complete your embedded antenna design. Please follow our technical advice carefully to obtain optimum antenna performance.

It is our goal that every customer will create a high performing wireless product using Antenova's antennas. You will find a wealth of design resources, calculators and case studies to aid your design at our website.

Antenova's design laboratories are equipped with the latest antenna design tools and test chambers. We provide antenna design, test and technical integration services to help you complete your design and obtain certifications.

If you cannot find the antenna you require in our product range, please contact us to discuss creating a bespoke antenna to meet your requirement exactly.

Contacts

Join our online antenna design community: ask.antenova.com

Order antenna samples and evaluation boards at: www.antenova.com

Request a quotation for antennas by volume: sales@antenova.com

Global Headquarters:

**Antenova Ltd, 2nd Floor Titan Court, 3 Bishop Square,
Hatfield, AL10 9NA +44 (0) 1707 927589**

Copyright® Antenova Ltd. All Rights Reserved. Antenova®, gigaNOVA®, RADIONOVA®, the Antenova product family names and the Antenova logos are trademarks and/or registered trademarks of Antenova Ltd. Any other names and/or trademarks belong to their respective companies. The materials provided herein are believed to be reliable and correct at the time of printing. Antenova does not warrant the accuracy or completeness of the information, text, graphics or other items contained within this information. Antenova further assumes no responsibility for the use of this information, and all such information shall be entirely at the user's risk.

Antennas for Wireless Applications

Mouser Electronics

Authorized Distributor

Click to View Pricing, Inventory, Delivery & Lifecycle Information:

[Antenova:](#)

[A10192H](#) [A10192H-EVB-1](#)