

# User Manual

## MAKE LIFE DIFFERENCE

---

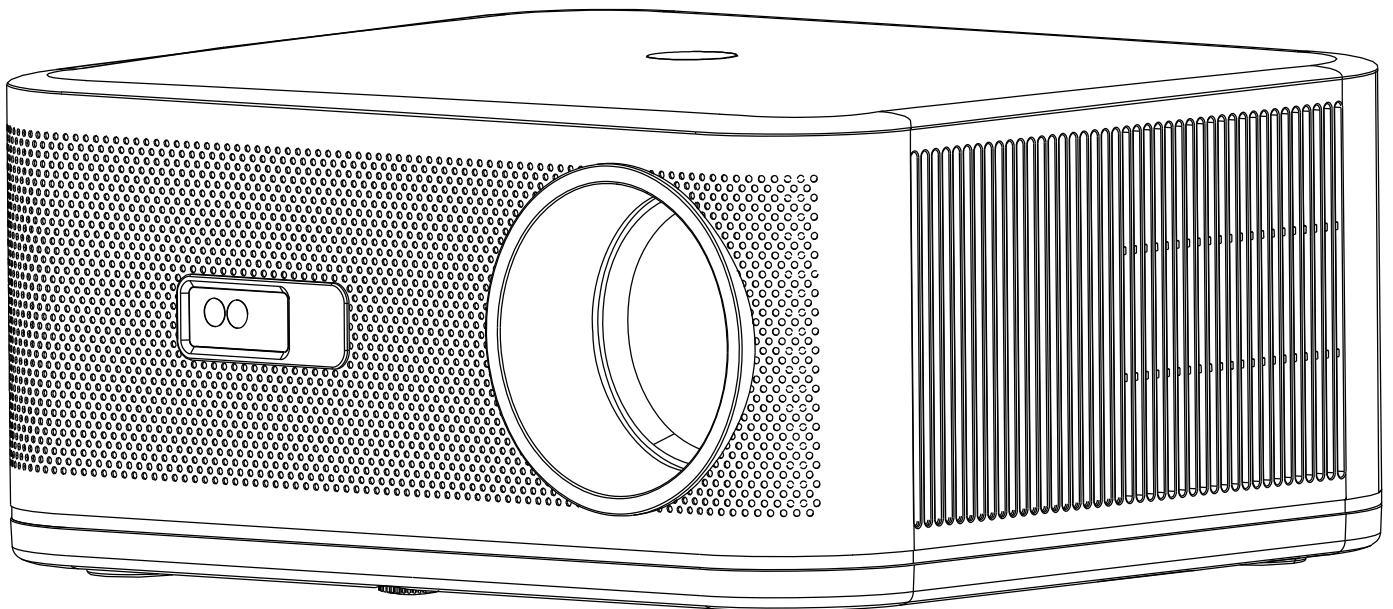

**Model : JQ820**

**Please read this manual carefully  
before using the projector.**

## **WARNINGS**

1. Do not look directly into the projector light.
2. Don't touch the projecting lens.
3. Mains adapter is used as a disconnect device and it should remain readily operable during intended use. In order to disconnect the apparatus from the mains completely, the mains plug should be disconnected from the mains socket outlet completely.
4. Use of controls or adjustments or performance of procedures other than those specified may result in hazardous radiation exposure.
5. Changes or modifications to this unit not expressly approved by the party responsible for compliance could void the user's authority to operate the equipment.
6. Use of this unit near fluorescent lighting may cause interference regarding the use of the remote. If the unit is displaying erratic behavior move away from any fluorescent lighting, as it may be the cause.
7. Shock hazard - Do Not Open.
8. Caution and marking information is located at the rear or bottom of the apparatus.
9. **WARNING:** To reduce the risk of fire or electric shock, do not expose this apparatus to rain, moisture, dripping, or splashing.
10. Objects filled with liquids, such as vases, shall not be placed on the apparatus.

# PRODUCT OVERVIEW

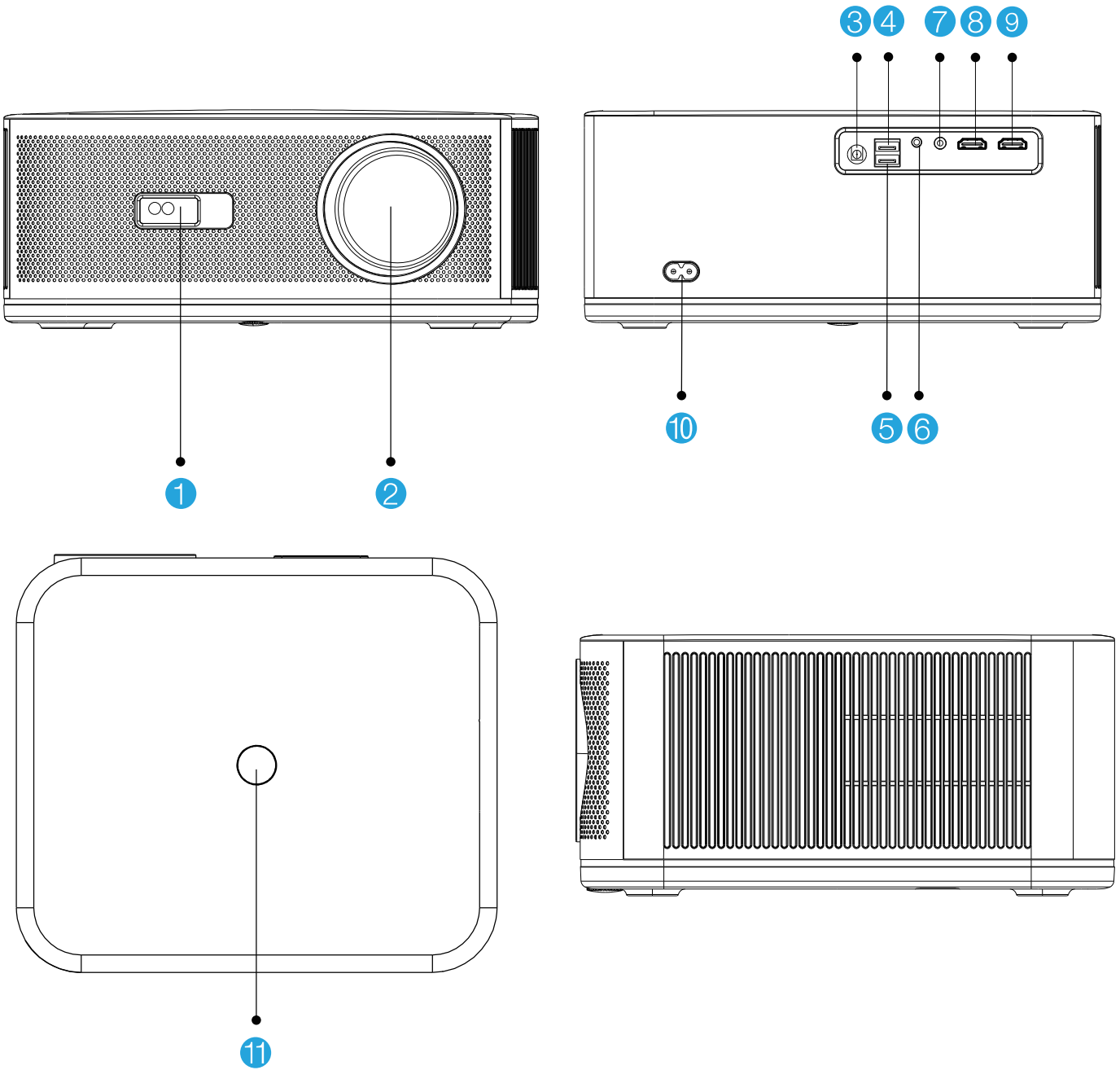

① IR Receiver

② Lens

③ IR Receiver

④ USB 1

⑤ USB 2

⑥ Headphone Jack

⑦ AV Port

⑧ HDMI 1

⑨ HDMI 2

⑩ Power Jack

⑪ Power Key

# REMOTE CONTROL

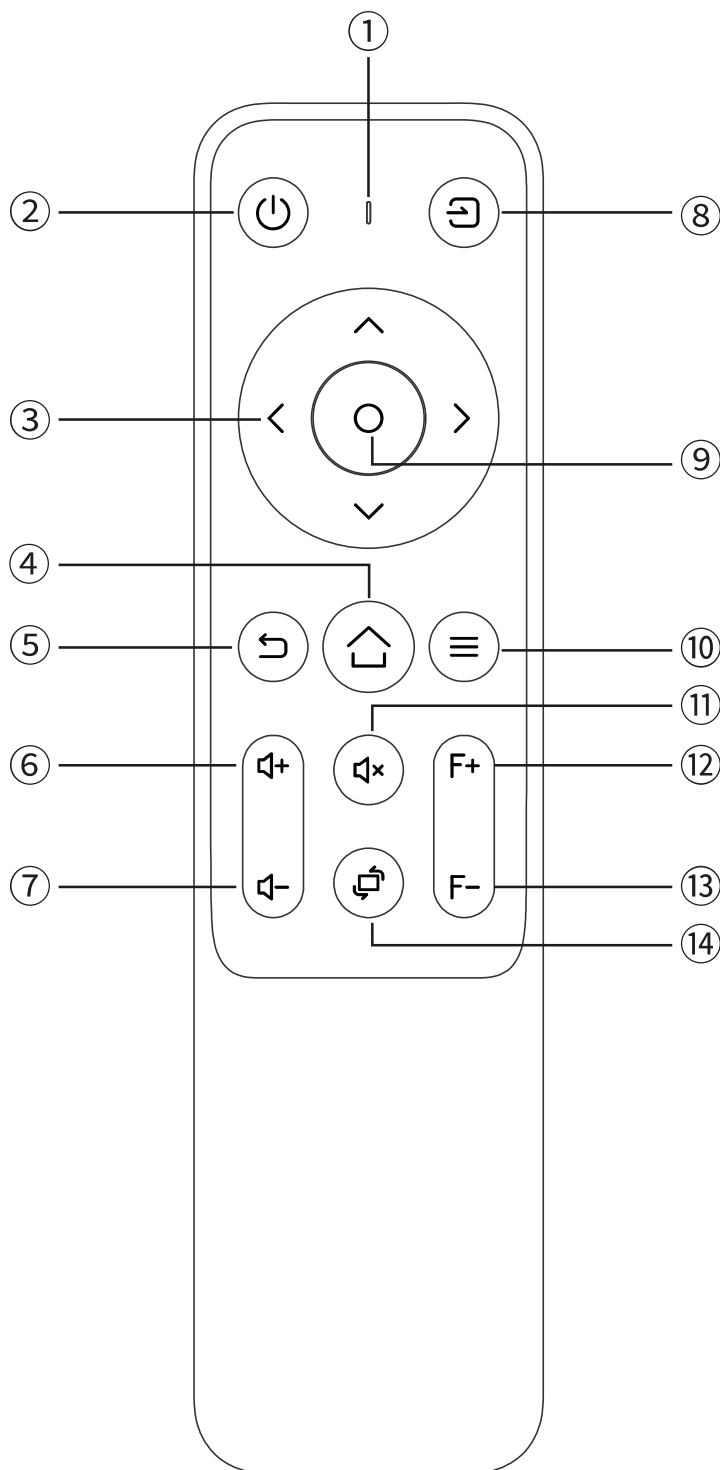

1. Signal Indicator
2. Power Key
3. Arrow keys
4. Home Key
5. Return key
6. Volume+
7. Volume-
8. Source key
9. Confirmation key
10. Menu
11. Mute Key
12. Focus+
13. Focus-
14. Screen Flip

## Note:

Before using the remote control, put two AAA batteries into the back cover of the remote control.

## PRODUCT SPECIFICATIONS

Native Resolution	1920*1080P
Flip	360°
Projection mode	Desktop Front Projection / Desktop Rear Projection/ Ceiling Mounted Front Projection/ Ceiling Mounted Rear Projection
Projection Lens	6 Slices Glass Lens
Aspect Ratio	16:9/4:3
Lamp	LED, 100000 Hours
Power Supply	AC100V-240V~50/60Hz

## MULTIMEDIA SUPPORTED FILES

①Audio Format	MP3/AAC/FLAC/OGG/MAV/WMA /M4A
②Image Format	BMP/JPG/JPEG/PNG
③Video Format	3GP/AVI/FLVI/MKV/MP4/MPG/WMV /RMVB/RM/TRP/VOB/DIVX/TP/TS/ DAT

# STARTING PROJECTOR

## 1. Power on/Power off

5 seconds after power-on, then press the power key  on the projector panel or the remote controller to turn on the device. Press the power key on the projector control panel or the remote control to turn off the device.

When the machine is turned off, unplug the power line in time to save energy.

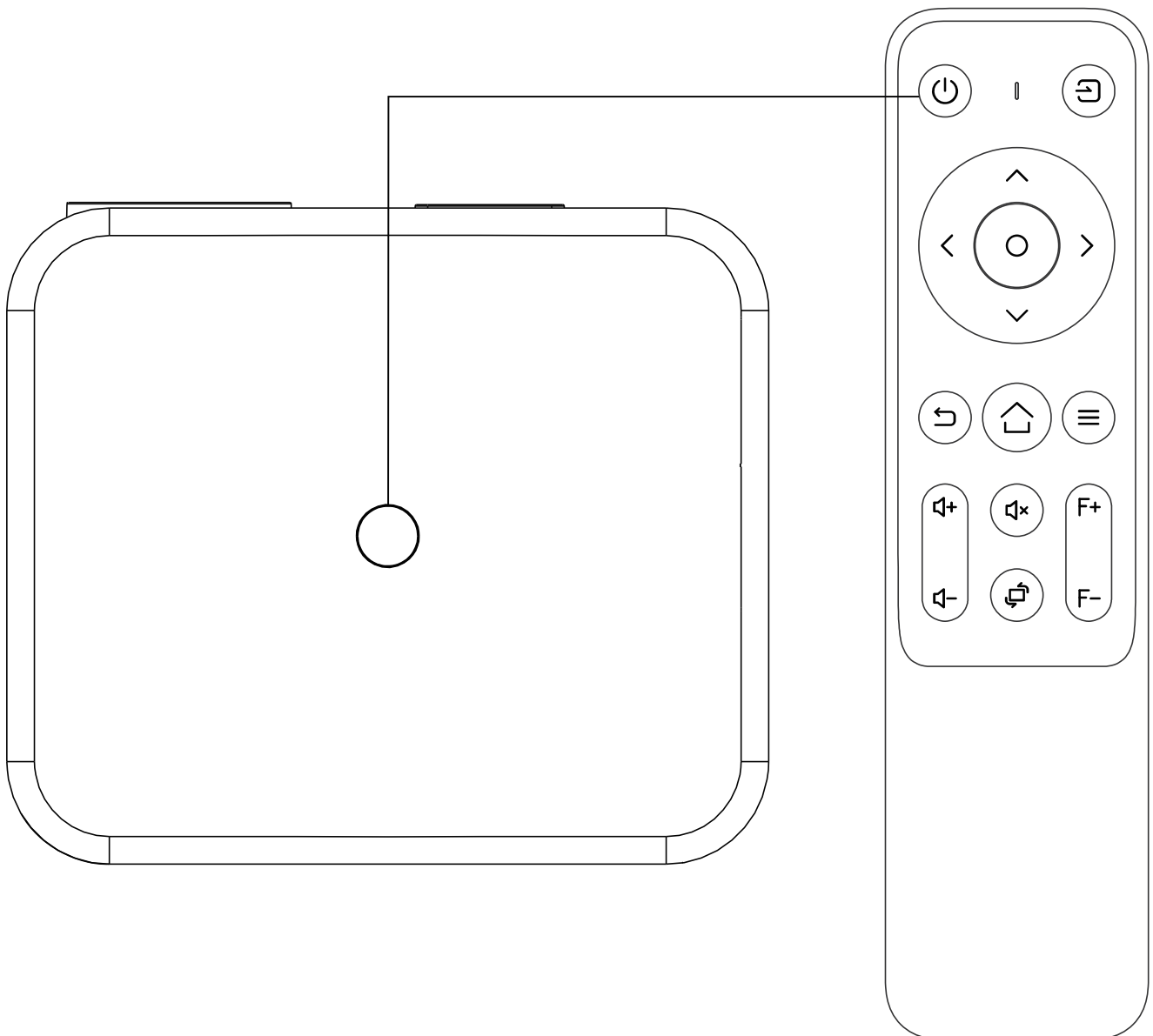

# CONNECTING

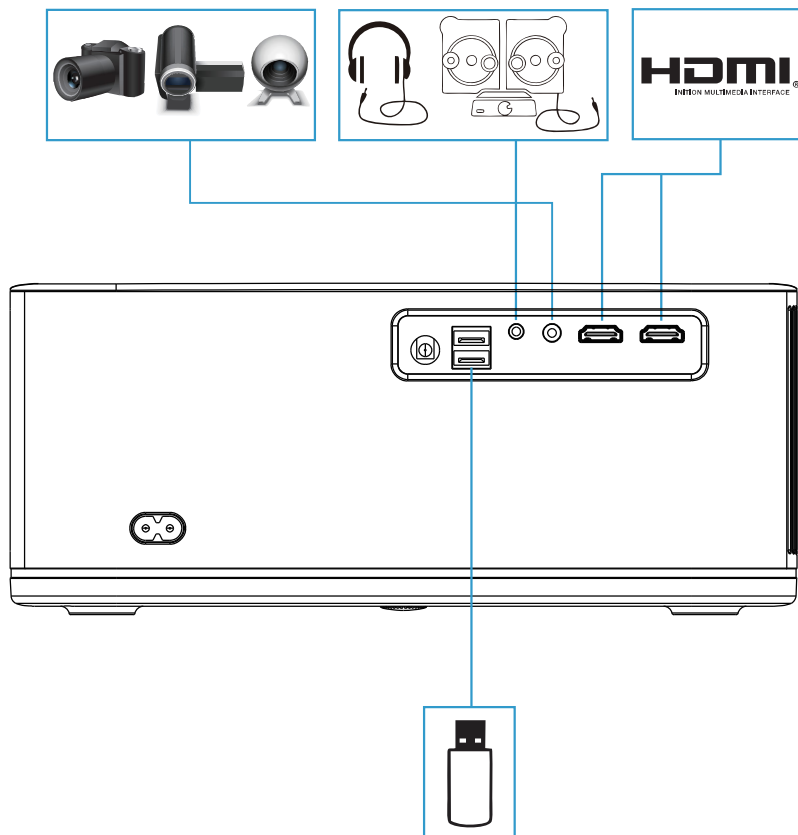

## 1. Select Signal Source

Press “  ” of the remote control, enter the signal source menu.

Use the arrow keys     and the “OK” to select the signal source.

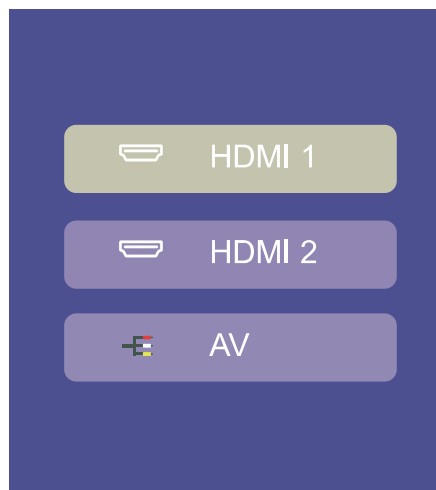

# CONNECTING

## 2. Wireless Screen Mirroring

### (1) Connect Smartphone

#### For iPhone

1. Open the main interface, click on "Setting" enter the settings page, select "WiFi Setting," perform the network configuration operation, and connect to your home network.

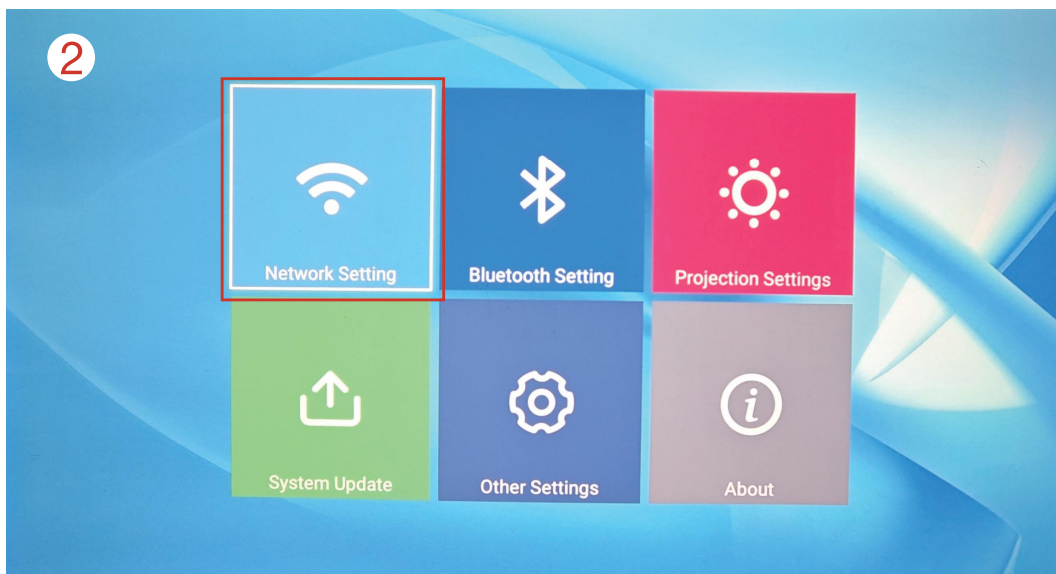
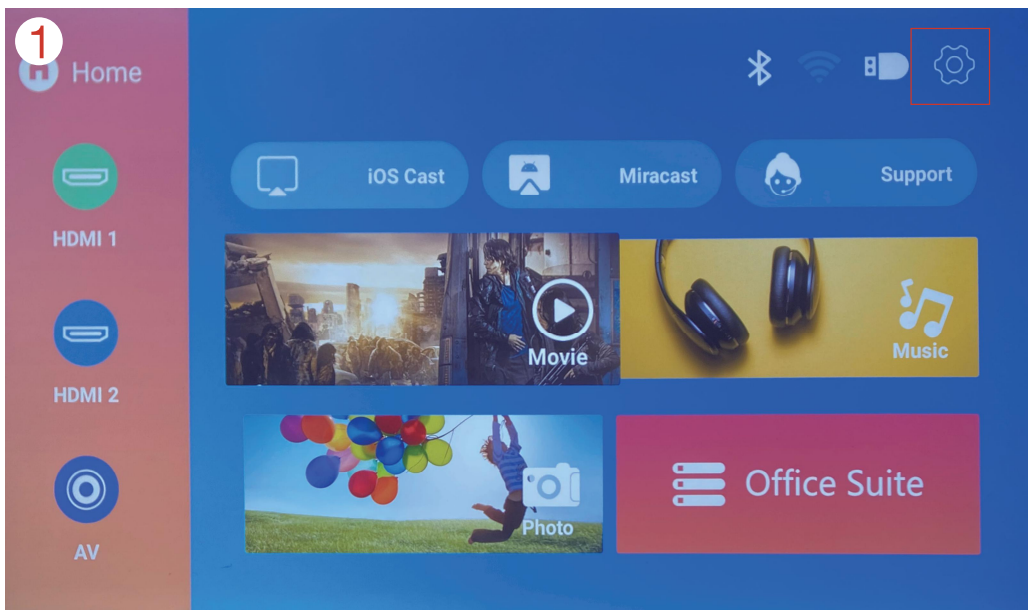





2. Return to the main interface and click "iOS Cast" to enter the screen mirroring page.

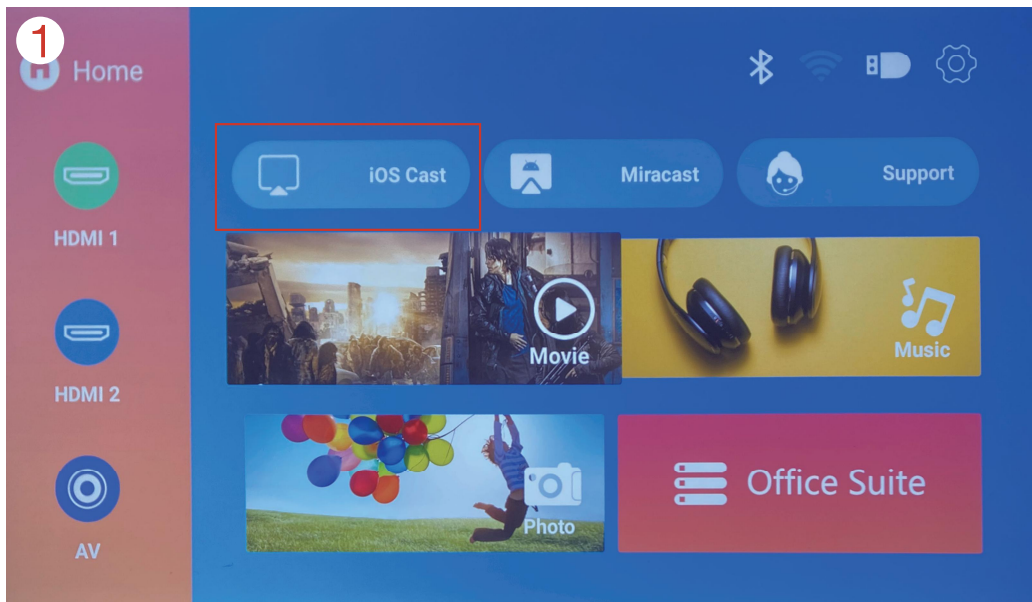

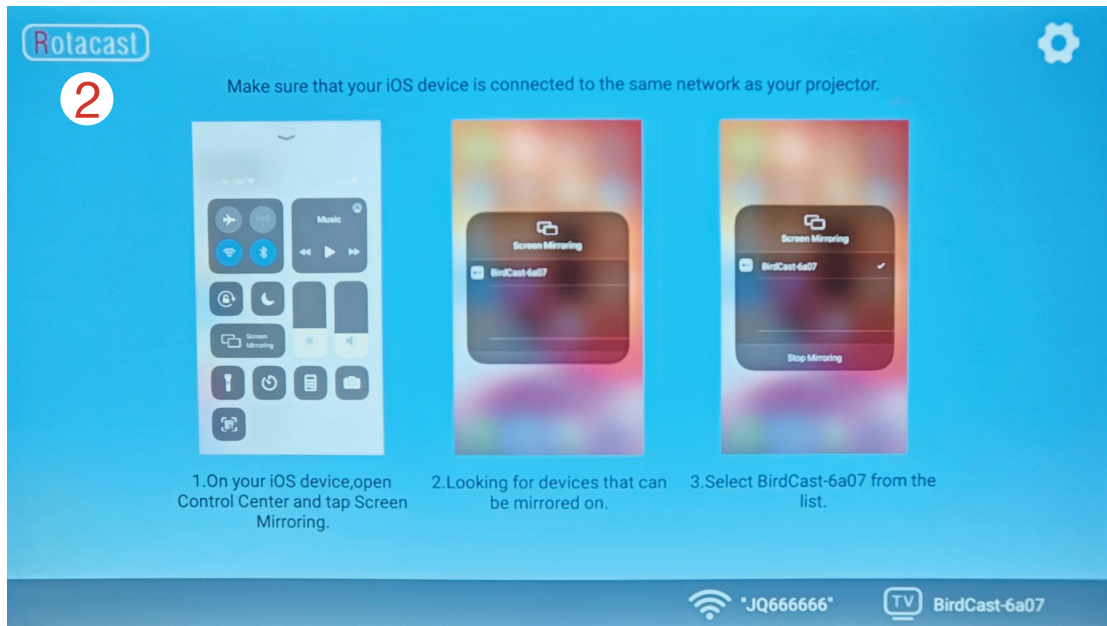

## For iPhone

3. Your iOS phone should be connected to your home network while also being connected to the same network as the projector. Swipe down from the top of the iPhone interface to enter the control center, then click "Screen Mirroring" and select "BirdCast - \*\*\*\*\*" to complete the connection.

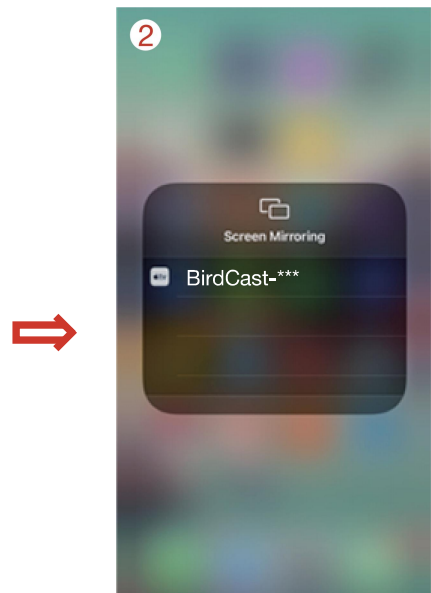
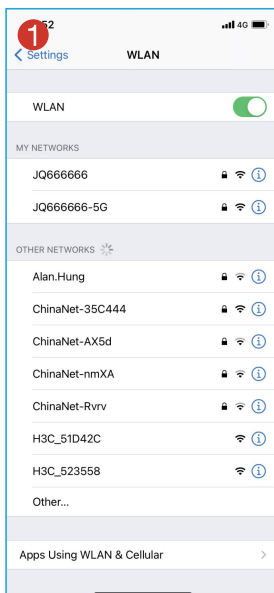

## Android Mobile/iPad

- ① Select "Miracast" in the main interface of the projector.
- ② Slide down from the top of the Android mobile/iPad interface to enter the control center, then click "Screen Mirroring" and select "NEWLINK-\*\*\*" to complete the connection.

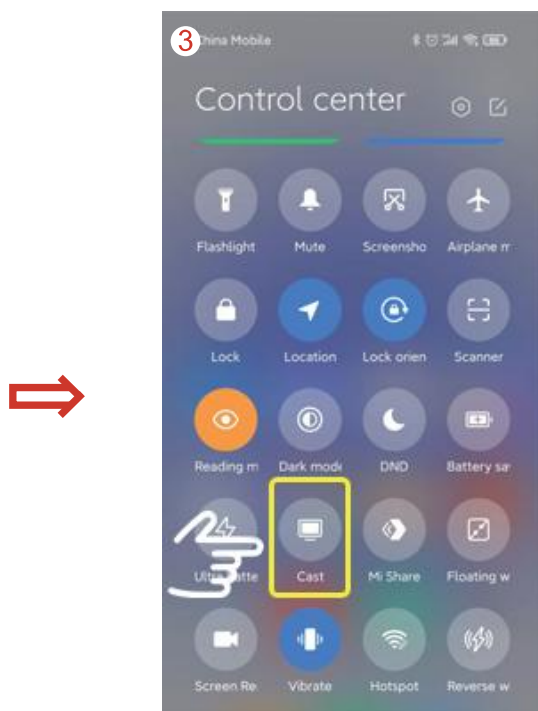
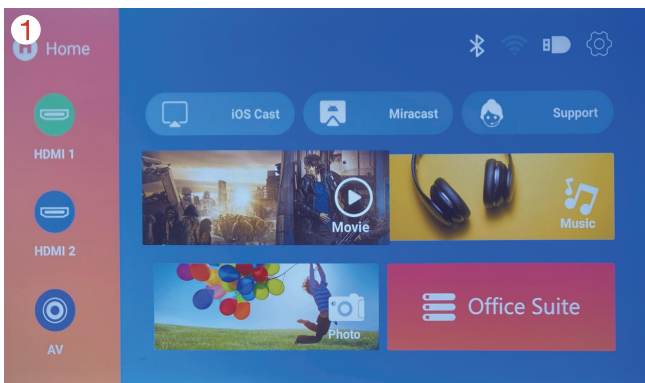

### 3. Connecting to HDMI Devices

The projector can connect to devices with the HDMI output function. Compatible with Laptop, DVD players, Blu-ray players, Chromecast, TV Stick, etc. (HDMI cable is included).

- ① Use the HDMI cable (included in the package) to connect the HDMI device to the projector
- ② Select media signal channel: "HDMI".

**Add: Different brand laptop output keys are as follows:**

Lenovo	Fn+F3
Dell	Fn+F8
HP	Fn+F4
ThinkPad	Fn+F7
Asus	Fn+F8

Acer	Fn+F5
Samsung	Fn+F4
Sony	Fn+F7
Fujitsu	Fn+F10
Haier	Fn+F3

NEC	Fn+F3
Panasonic	Fn+F3
Sharp	Fn+F5
Hitachi	Fn+F7
TOSHIBA	Fn+F5

The user of Windows 7 or over Windows 7. Simply press the  + P, and select duplicate to connect. If the operation above is invalid, please update the computer graphics driver.

## CONNECTING

### 4. Connect the USB drive

- ① Plug a USB drive into the USB port of the projector, and when "USB" is in the upper right corner of the projector, connect successfully.
- ② To play a video, picture, music, or text stored in a USB drive, select "Movie"/ "Photo"/ "Music"/"Text" on the main menu, and press "OK".

#### Note:

The chip of this projector is not compatible with files (Microsoft Office, PDF, and text) on the USB stick (If you want to play files, please keep the files on your laptop or DVD player, then connect this projector to them.)

### 5. Connect AV video devices

- ① Use the 3 in 1 video cable (Included in the package) to connect with AV.
- ② Choose the media signal channel: "AV".

### 6. Connect 3.5mm audio devices

Support 3.5mm earphones and other cable sound devices.

### 7. Connect Bluetooth audio

#### Warm Tips:

Bluetooth projector can only be used to connect sound devices such as speakers, headphones, sound bar, etc, not to computers or smartphone.

# PROJECTION IMAGE SETTING

Select Settings, click to enter Projection Settings



1. Projection Mode, there are four modes, Front Desktop/Rear Desktop/Front Ceiling /Rear Ceiling.



2. Keystone Advanced, select side, 4-Point Keystone appears, enter this option, and perform manual keystone correction.

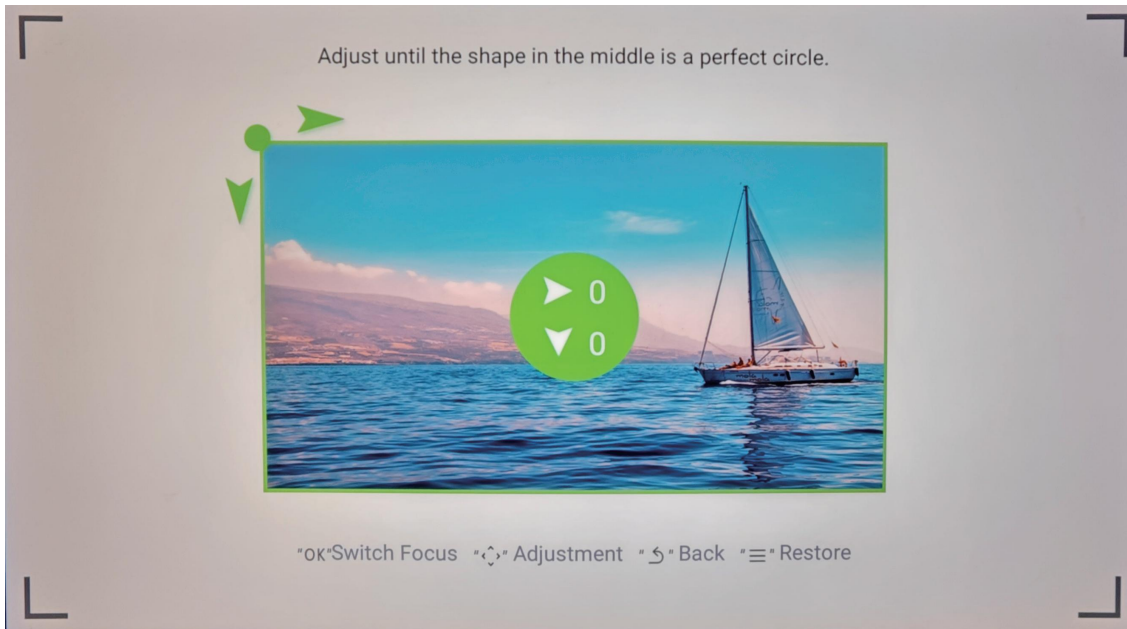

3. Digital zoom, you can manually adjust the digital focus distance, 50-100 digital focus distance

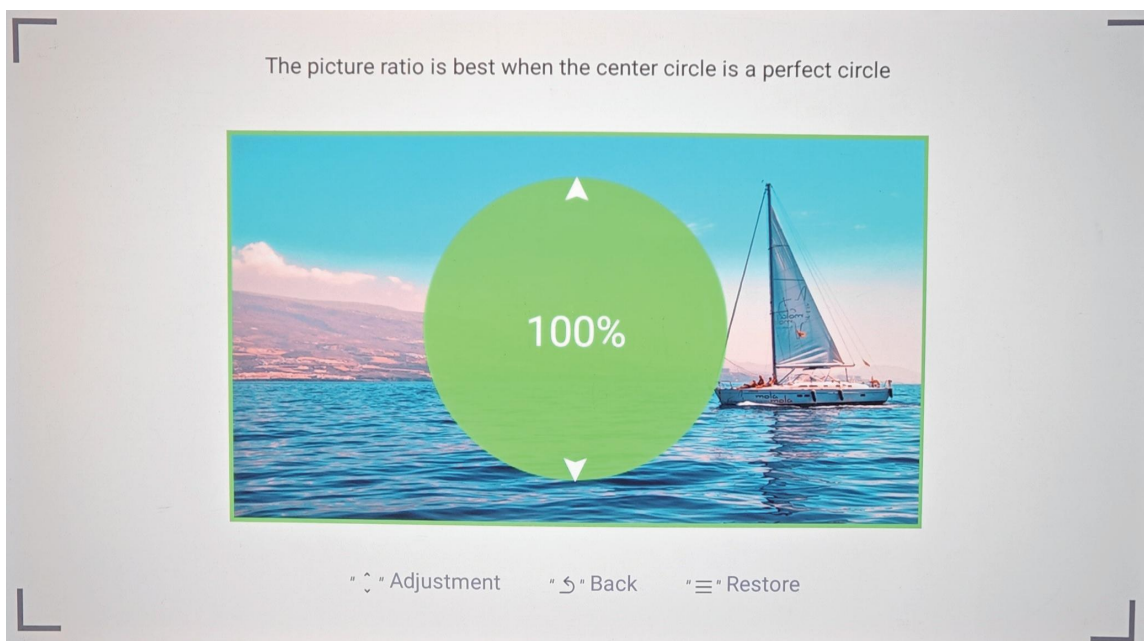

# WIFI SETTING

Select and click to enter Network Setting

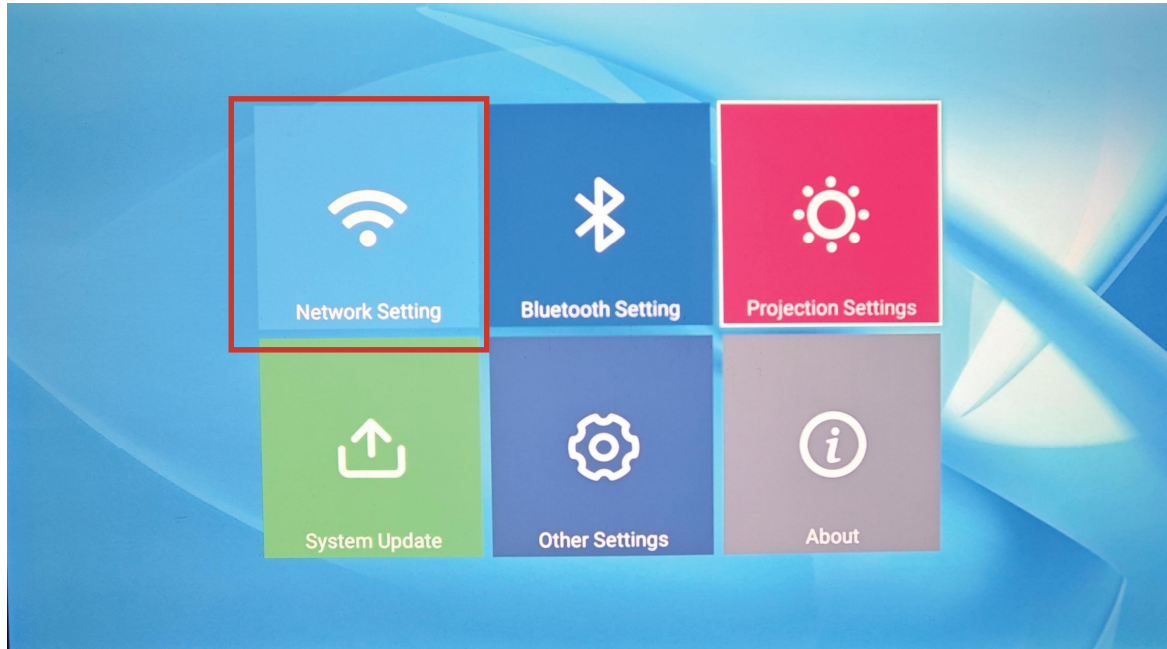

When WiFi is set to "ON", WiFi is turned on and can automatically search for WiFi signals, find your home network, enter the WiFi password and log in to connect.

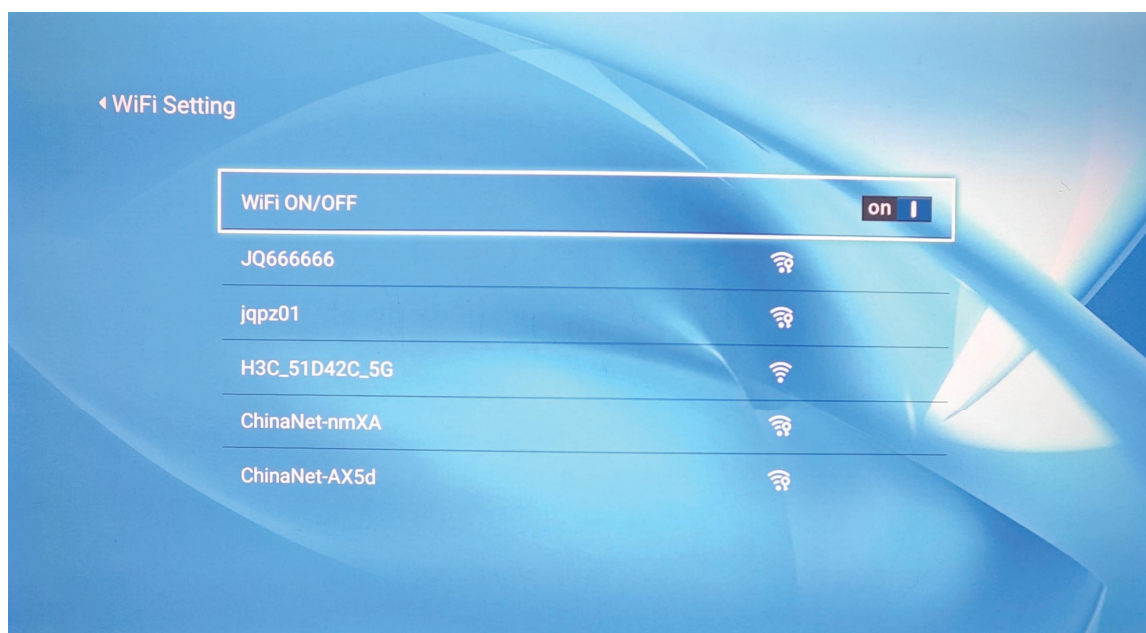



# BT Setting

Select Bluetooth Setting click to enter



1. Press "ok" to turn on Bluetooth.

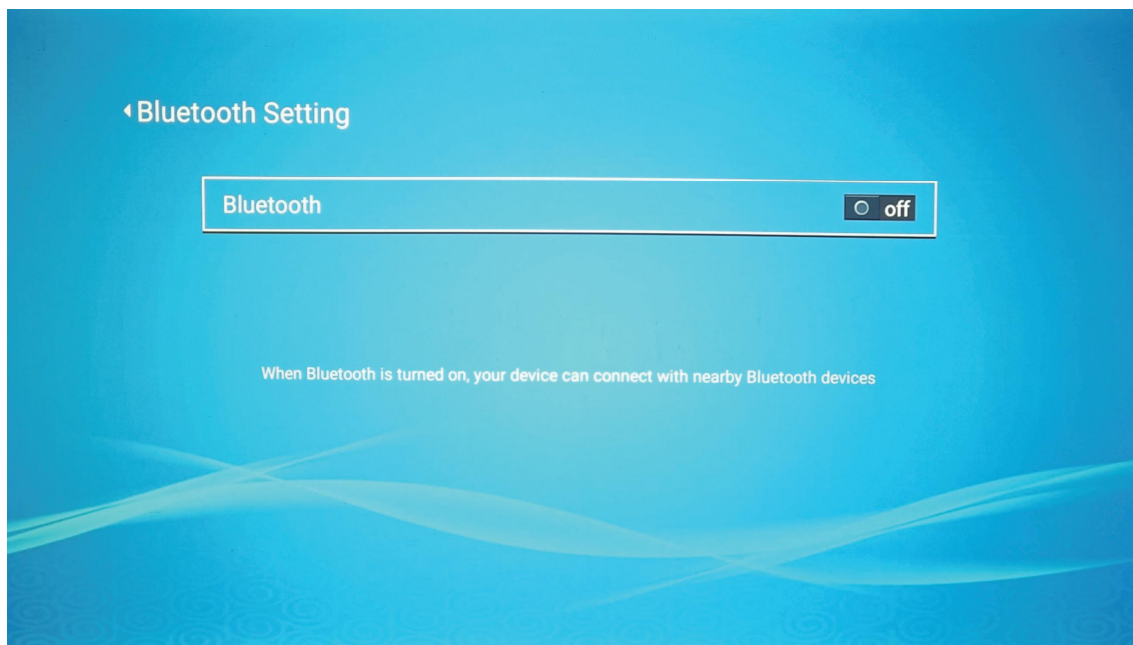

2. Select Manual setting, select Scan for devices down, and select your Bluetooth connection.

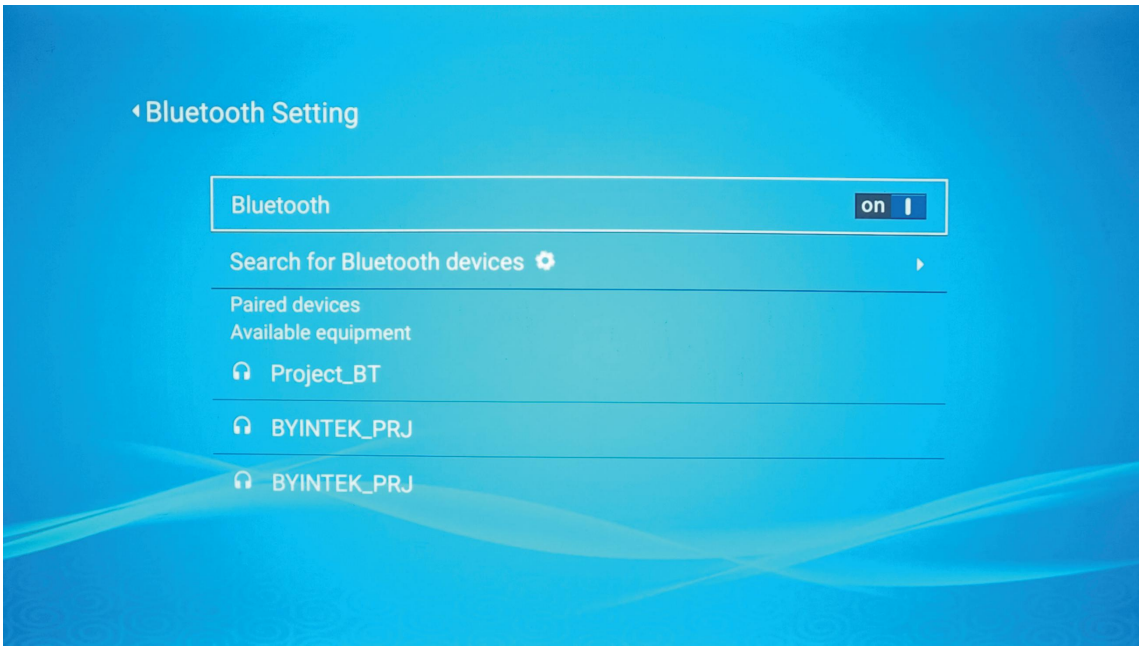

## OTHER SETTING

Select Other Setting and click to enter this setting

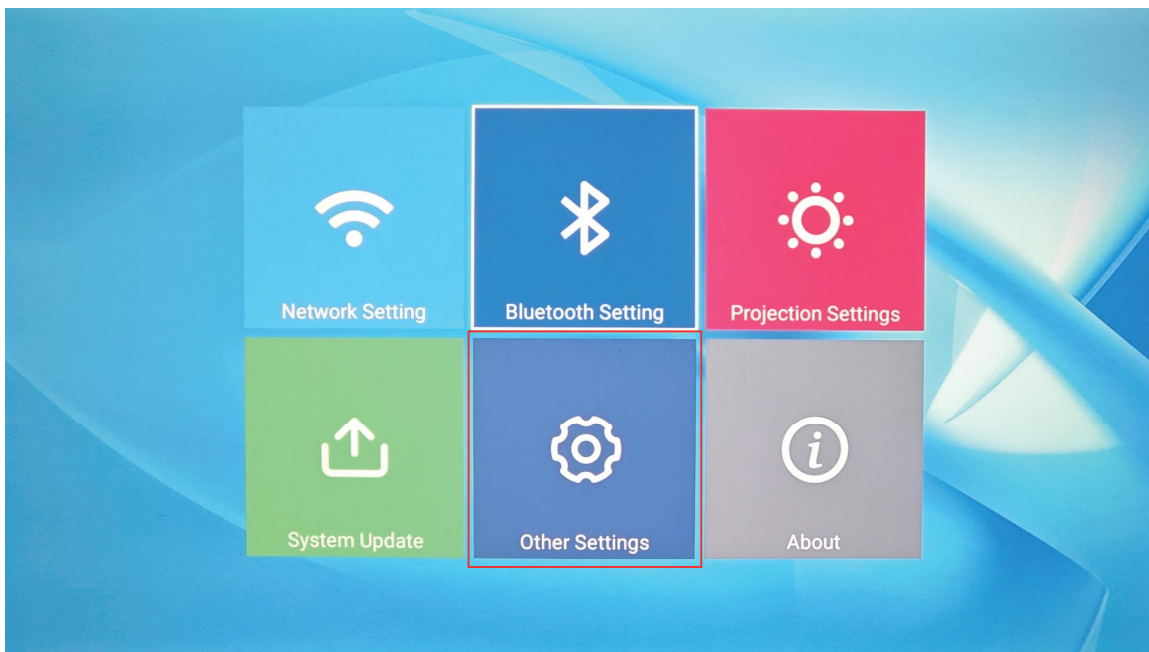

Select Language Setting, you can set the language of different countries.

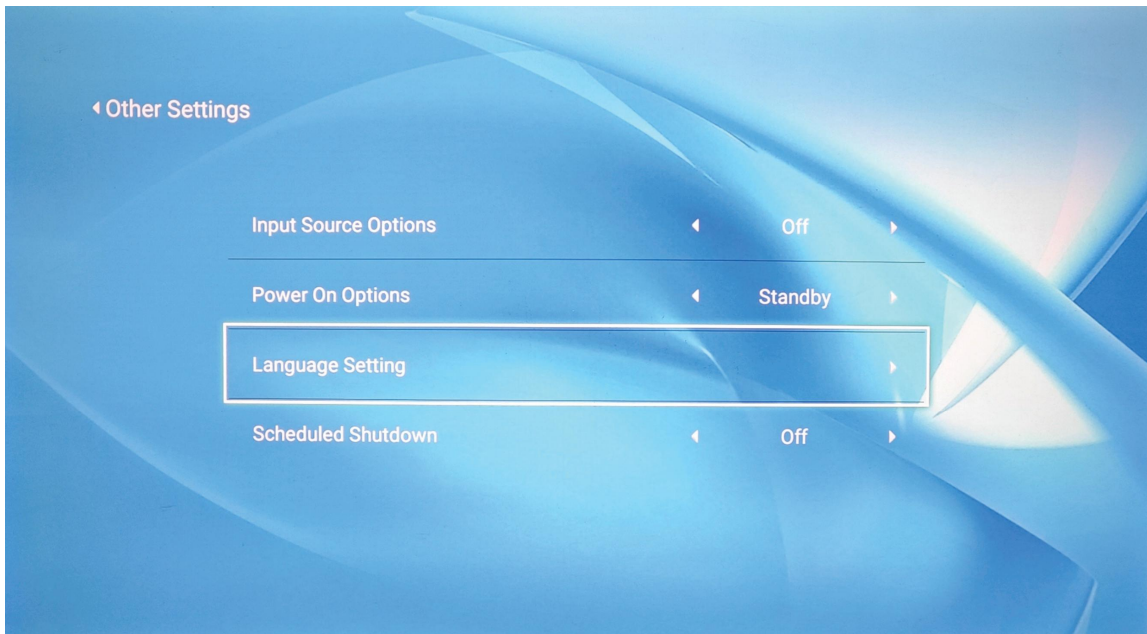

## SYSTEM UPGRADE

Select System Upgrade

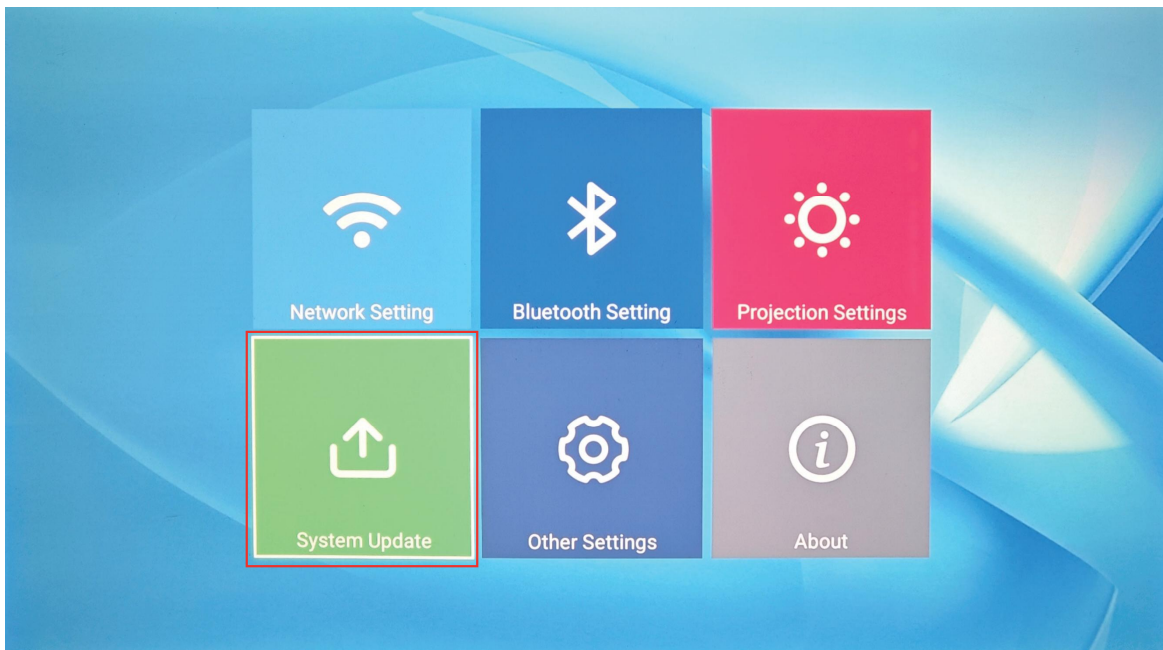

Click to enter "Factory Reset", you can restore the system to its original state.

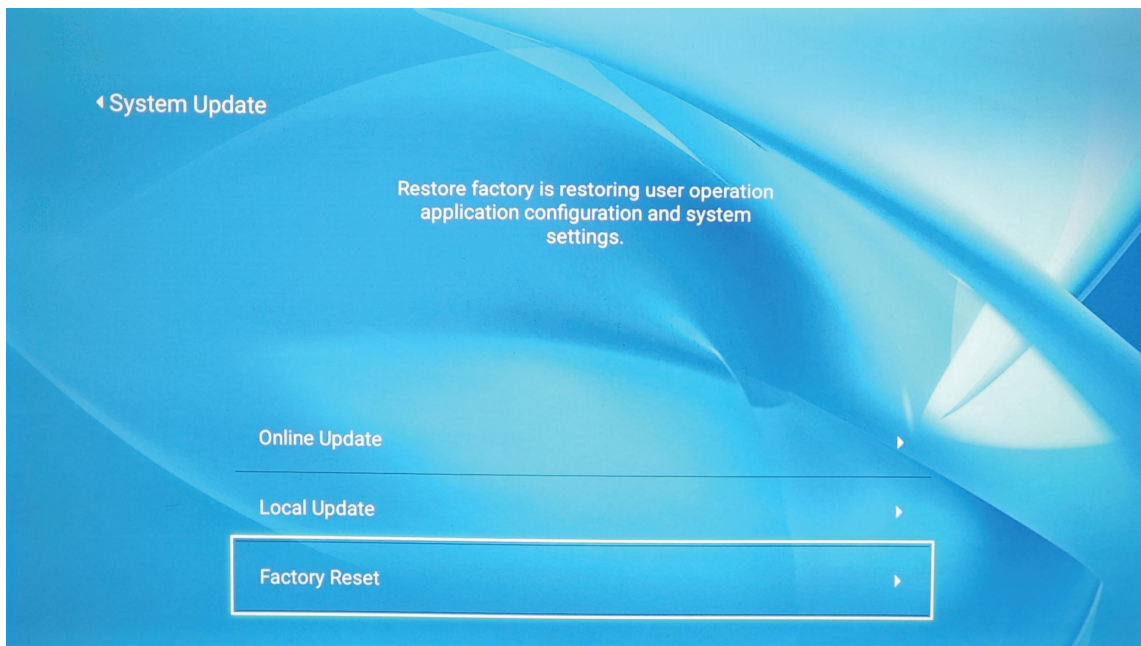

## ■ TROUBLESHOOTING

### 1. Why is the display of the projector available but without audio?

- \* The Projector or the connected device (PC, DVD, etc.) is muted.
- \* Due to Dolby's copyright issues, the current regular projectors selling on Amazon do not support Dolby sound, So there will be no sound when you play Dolby sound videos, (Amazon fire stick, Netflix, Blue-ray movies, and so on) In this case, please kindly turn off the Dolby sound on your device or apps.  
(Settings > Display & Sounds > Audio > Dolby Digital Output > and then turn Dolby Digital (OFF))
- \* The audio format is not supported by the projector.
- \* Encryption applied to the videos or media player which holds the video. Try more videos to define this possibility.

### 2. Why is the audio of the projector available but without a display?

- \* The video format is not supported by the projector.
- \* Encryption applied to the videos or media player which holds the video.

\* If the lamp of the projector is off with only audio playing, the lamp is defective. Please contact the Customer Service Team for a replacement.

\* Try another HDMI cable if you select the HDMI input source.

### **3. Why does the projection screen show no signal?**

\* Make sure all cables are plugged correctly and firmly.

\* Make sure you select the right input source. For example, if you insert a USB drive, please select USB in the interface of Input Source.

### **4. How can I do if the image is blurry or out of shape?**

\* Adjust the focus and keystone ring by moving it leftward/rightward till it shows the best images.

\* Place the projector on a flat surface horizontally or vertically. An inclination of any angle may result in blurry displays or uneven colors.

\* Projecting wall or screen be clean white if possible.

### **5. How can I do if the image is upside down?**

\* Enter Menu-Picture-Projection Direction to flip the projection image accordingly.

### **6. How can I do if the projection screen is not square or allied horizontally?**

\* Make sure the projector is placed on a flat surface with a projector light in the middle of the screen.

\* Make sure the projector screen is placed horizontally.

### **7. How can I do if there is color distortion?**

\* Make sure the video source has a fine resolution.

\* Adjust the colors: enter Menu-Picture-Color Temperature, then select different modes and adjust the value accordingly.

\* Reset the projector to manufacturer setting: enter Menu-Option Restore Factory Default to reset.

## **8. How can I do if the remote is unresponsive?**

- \* Make sure the batteries are installed correctly and the power is enough.
- \* The remote works with the projector through the IR receiver. The remote works only when the IR receiver is within the direct reaction distance and will be unresponsive if the IR receiver is blocked or covered.

## **9. How should I do if there are small dots on display?**

- \* It may be caused during installing or shipping, please contact HAPPRUN to get the video about how to clean it.

## **10. Why do some lag/ jerky appear when playing video or play games?**

- \* Due to the technical bottleneck of the current 1080p projectors, most of the 1080p projectors on the market cannot smoothly play 1080p/60fps videos. Hope you could understand.

Please change the 1080p/60fps to 1080p/30fps.

## **11.How to Connect and Watch Netflix?**

All projector with mirror display doesn't support playing protected video when you connect it to your smartphone directly. (Netflix, Prime Video, Hulu, etc)

Because these videos have an encryption protocol, the projector has no right to recognize when it is connected directly to the phone via the USB interface. Hope you understand. (Projector without mirror display, need an HDMI adapter if you want to connect it to your smartphone)

## **Please follow the ways below to watch Netflix**

**First Solution:**

You can watch Netflix via Chromecast/laptop/TV stick/Roku on our projector.

**Second Solution:**

You can connect the computer/ Smart TV to the projector through HDMI when playing movies from Netflix

**Third Solution:**

You can buy a Wireless HDMI Dongle to mirror your phone.

The reason why the fire stick or other HDMI device can play Netflix is that the HDMI interface encryption protocol includes Netflix's.

It works with youtube, chrome, safari, and Facetime when you connect it to a smartphone directly.

## **TOP SERVICE:**

Any questions about this item, please

 **1-888-986-2646(US)**

 **[service@happrunlife.com](mailto:service@happrunlife.com)**

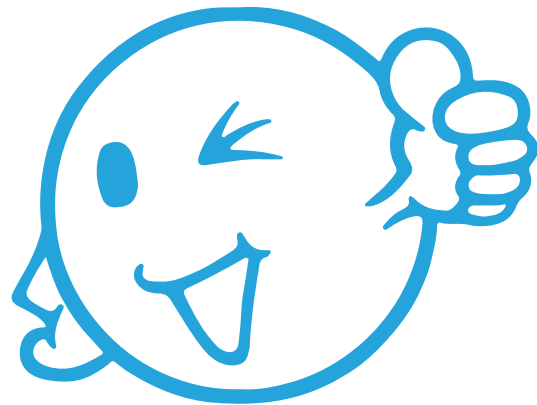



## FCC Warning

This device complies with part 15 of the FCC Rules. Operation is subject to the following two conditions: (1) This device may not cause harmful interference, and (2) this device must accept any interference received, including interference that may cause undesired operation.

Any Changes or modifications not expressly approved by the party responsible for compliance could void the user's authority to operate the equipment.

**Note:** This equipment has been tested and found to comply with the limits for a Class B digital device, pursuant to part 15 of the FCC Rules. These limits are designed to provide reasonable protection against harmful interference in a residential installation. This equipment generates uses and can radiate radio frequency energy and, if not installed and used in accordance with the instructions, may cause harmful interference to radio communications. However, there is no guarantee that interference will not occur in a particular installation. If this equipment does cause harmful interference to radio or television reception, which can be determined by turning the equipment off and on, the user is encouraged to try to correct the interference by one or more of the following measures:

- Reorient or relocate the receiving antenna.
- Increase the separation between the equipment and receiver.
- Connect the equipment into an outlet on a circuit different from that to which the receiver is connected.
- Consult the dealer or an experienced radio/TV technician for help.

This equipment complies with FCC radiation exposure limits set forth for an uncontrolled environment. This equipment should be installed and operated with minimum distance 20cm between the radiator & your body.

## IC Warning

- English: This device contains licence-exempt transmitter(s)/receiver(s) that comply with Innovation, Science and Economic Development Canada's licence-exempt RSS(s). Operation is subject to the following two conditions:

1. This device may not cause interference.
2. This device must accept any interference, including interference that may cause undesired operation of the device.

- French: Cet appareil contient des émetteurs/récepteurs exemptés de licence qui sont conformes aux RSS exemptés de licence d'innovation, sciences et développement économique Canada. Le fonctionnement est soumis aux deux conditions suivantes:

1. Cet appareil ne peut pas causer d'interférences.
2. Cet appareil doit accepter toute interférence, y compris les interférences qui peuvent causer un fonctionnement indésirable de l'appareil.

This equipment complies with ISED radiation exposure limits set forth for an uncontrolled environment. This equipment should be installed and operated with minimum distance 20cm between the radiator & your body.

Ce matériel est complété par une exposition de rayonnements ISED pour un environnement naturel. Ce matériel doit être installé et se faire avec une distance minimale de 20cm entre les radiateurs et les autresYour body shop.