

# ZMLH-A5

## AI intelligent skin tester

User manual

Welcome to the world of Moji  
Explore skin secrets with Moji!

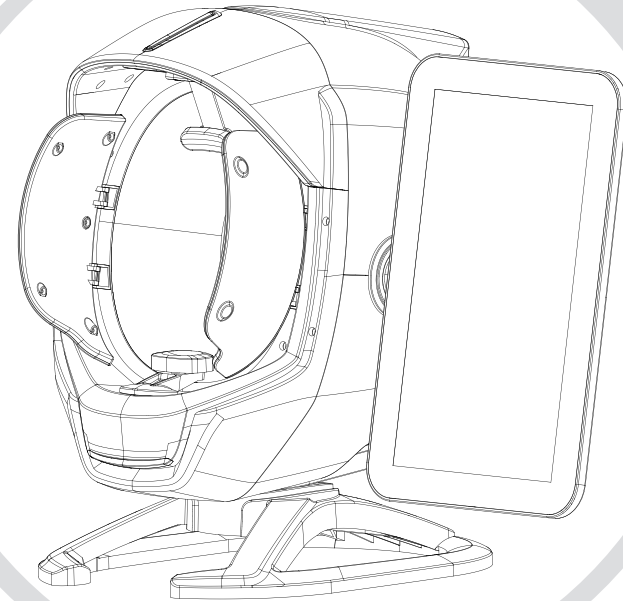

Model NO:ZMLH-A5

### AI intelligent skin tester (ZMLH-A5) product list

Name	Label	Quantity	Option (√)	Remark
Host machine		1pcs	√	
Power cord		1pcs	√	
Certificate		1pcs	√	
Warranty		1pcs	√	
Specification		1pcs	√	

Warm reminder: Please be sure to confirm whether the product accessories are complete before receiving the goods!

## Statement

The information contained in this manual is based on experience and knowledge gained prior to the publication of this manual in the product area discussed.

Believe that the information provided in this manual is accurate and reliable, but make no warranties of any kind, including, but not limited to, implied warranties of merchantability and fitness for a particular purpose, will not be liable for any loss or damage, including any special damage resulting from or resulting from the use of this information, even if the loss or damage is caused by negligence or other error.

The contents and information of this manual shall not be reproduced and transmitted without permission of copyright. Changes are made without notice due to the contents contained in the product upgrade and improvement instructions.

Please read this manual carefully before installing and using ZMLH-A5-AI intelligent skin tester.

**This product appearance,interface,software,part of the function of a number of patents have been declared,plagiarism must be investigated!**

## Contents

<b>1. Safety Information</b> .....	<b>1</b>
1.1 Safety Overview.....	1
1.2 Electrical / Mechanical Safety.....	1
1.2.1 Mechanical Safety.....	1
1.2.2 Electrical Safety.....	2
1.2.3 Environmental Safety .....	2
1.2.4 Operational Safety .....	2
1.3 Appropriate Users and Inappropriate Users.....	3
1.3.1 Appropriate Users.....	3
1.3.2 Inappropriate Users.....	3
1.4 Symbols and Labels .....	3
1.4.1 Safety Symbols.....	3
1.4.2 Transportation Symbols.....	4
1.4.3 System Label.....	4
<b>2. Introduction</b> .....	<b>5</b>
2.1 Summarize .....	5
2.2 Anticipated use.....	5
2.3 Electrical and packing parameters .....	5
2.4 Transportation and storage requirements .....	5

<b>3. Installation</b> .....	<b>6</b>
3.1 Site requirements .....	6
3.1.1 Operating environment requirements .....	6
3.1.2 Power requirement .....	6
3.2 Unpack .....	6
3.3 Installation procedure.....	6
<b>4. Operation Instructions</b> .....	<b>7</b>
4.1 ON and OFF.....	7
4.1.1 Switch ON .....	7
4.1.2 Switch OFF .....	9
4.2 Instructions for use .....	9
4.2.1 Function operation instruction.....	9
<b>5. Maintenance and Caring</b> .....	<b>10</b>
5.1 Troubleshooting .....	11
5.2 Maintenance Services .....	12
5.2.1 Function Operation Application.....	12
5.2.2 Not Under Warranty.....	13
5.2.3 Warranty Card .....	14

# 1. Safety Information

## 1.1 Safety Overview

According to the electrical safety classification, this equipment belongs to Class 1, portable ordinary equipment.

Here is an overview of safety precautions:

- ◆ The operator shall not open the enclosure of the equipment under any circumstances.
- ◆ In the working state, do not move the device, such as the use of support, please lock the support casters.
- ◆ If the equipment does not work properly, do not carry out maintenance yourself. Should immediately contact the relevant after-sales personnel.

## 1.2 Electrical / Mechanical Safety

Only trained and qualified maintenance personnel should open the casing of the equipment to replace electrical and mechanical parts, otherwise it may cause equipment safety issues.

The following is an overview of the warning messages:

### 1.2.1 Mechanical Safety

- ◆ This device is a desktop device. Before operation and use, determine the safe area for placing the instrument. If a support is used, please lock the casters of the support.
- ◆ The device must not be operated when the chassis is open.

### 1.2.2 Electrical Safety

- ◆ Lightning hazard - In order to protect users and operators, ensure that the metal shell of the equipment is grounded and the protective grounding of the power supply socket is intact.
- ◆ Electric shock hazard - Do not open the enclosure of the device during operation or when the power is connected, only authorized maintenance engineers can open it.

- ◆ Please turn off the system power before cleaning. Cleaning involves using a soft brush or cloth to remove dust from the surface of the device, using a brush to remove dust from the edge of the connector or panel, or using a non-corrosive cleaner such as a facial cleanser. Do not let the cleaner penetrate the inside of the device. Pay special attention to the connecting head, the edge of the display panel, etc.
- ◆ During the operation of the equipment, if there is an emergency, you can quickly cut off the power supply or unplug the power socket of the instrument through the power switch behind the equipment host to terminate the operation.
- ◆ If you find that the power plug or socket is too loose or the outer insulation of the power cord is damaged, please stop using it immediately to prevent fire or electric shock.
- ◆ If the power cord or accessories are damaged, you must buy special components from the manufacturer or maintenance department to replace them.

### 1.2.3 Environmental Safety

- ◆ Do not operate the equipment outside the operating environment limit, otherwise it will cause the equipment to work abnormally limited as follows:
  - A. The operating temperature ranges from: -10 °C to 45 °C
  - B. Relative humidity: ≤75%
  - C. Altitude: -500m to 4600m
  - D. Power supply voltage: 100 ~ 240VAC frequency: 50/60HZ
- ◆ Keep the environment clean and avoid shock. Keep away from corrosive drugs, dust, heat and humidity.
- ◆ Electromagnetic interference -- to ensure that the installation and use of the instrument environment is not subject to strong electromagnetic interference, such as wireless transmitters, mobile phones, etc.

### 1.2.4 Operational Safety

1. It should be operated by professionals or trained personnel to prevent wrong operation and fail to achieve the expected effect.

2. If you feel uncomfortable when using this instrument, stop using it immediately.
3. Power off and remove the power cable after use to ensure safety.
4. Do not unplug the device during operation.
5. In the process of use, if there is any abnormal situation, please turn off the power supply of the instrument immediately, and unplug the power cord of the instrument, and contact the relevant after-sales personnel immediately.
6. Turn off the power switch after the instrument is used, and remove the power input plug from the socket.
7. When maintaining the instrument, unplug the power input plug first.

### 1.3 Appropriate Users and Inappropriate Users

#### 1.3.1 Appropriate Users







◆ All people except those who are sensitive to RGB white light, positive polarized light, negative polarized light, UV light and wood's light.

#### 1.3.2 Inappropriate Users





◆ People allergic to RGB white light, positive polarized light, negative polarized light, UV light, wood's light.

### 1.4 Symbols and Labels

#### 1.4.1 Safety Symbols

	Functional earthing
	Protective earthing
	Dangerous voltage
	Consult the companying file
	Alternating current
	Manufacturer
	Production Date
SN	Series no



#### 1.4.2 Transportation Symbols

	Fragile & Be gentle
	Keep dry
	Don't tilt
	Overlap
	Upward placing

#### 1.4.3 System Label

## AI intelligent skin tester

Instrument model: ZMLH-A5  
 Power input: 100-240VAC 50/60HZ 0.8A  
 Instrument code:  
 Manufacturer: Shenzhen ZhimeiLihe Industrial Development Co., Ltd.  
 Manufacturer's address:

Note: Non-professional personnel are forbidden to disassemble the machine

**Qualified** PASS  
 Manufacturing Date

## 2. Introduction

### 2.1 Summarize

AI intelligent skin tester (ZMLH-A5) is a safe, reliable, intelligent and continuous deep learning, automatic update skin image device.

### 2.2 Anticipated use

- Capture images through spectral photography and perform intelligent analysis of skin problems
- Microscopically magnify the details of the skin and display the moisture detection area to make the data more comprehensive
- Description of skin problems

### 2.3 Electrical and packing parameters

Input: 100 ~ 240VAC

Frequency: 50/60HZ

Rated current: 0.8A

Packing size: 600\*580\*640mm(outer box)

### 2.4 Transportation and storage requirements

Temperature range: -10 °C~ 45 °C

Humidity range: ≤75%

Altitude: -500m to 4600m

The instrument is suitable for general transportation such as trains, cars, ships, aircraft, etc. During transportation, the instrument should be prevented from violent vibration, collision and falling, and should be placed upward, gently and moisture-proof.

The instrument should be stored in a non-corrosive gas and well-ventilated room, when the instrument is not used for a long time, it should be stored after cleaning, and it is best to take out the electricity for 1-2 hours a year to prevent moisture.

## 3. Installation

### 3.1 Site requirements

#### 3.1.1 Operating environment requirements

Ambient temperature during system operation: -10 °C to 45 °C

Relative humidity: less than 75%

#### 3.1.2 Power requirement

Power supply voltage: 100 ~ 240VAC

The power cord used in this instrument conforms to the national safety standard. Be sure to use the wall plug or row plug with the safe national standard wire, which is crucial to the operation safety.

### 3.2 Unpack

(1) Before opening the box, check the outer package for damage. If there is damage, it is necessary to contact the relevant sales outlets or sales personnel, and take photos for record. If the instrument is damaged, please contact the logistics company at the first time and handle the claim formalities.

(2) After unpacking, check whether the packing list is consistent with the material inside the box (on the back of the manual). If there is any shortage, please contact the seller of the instrument immediately.

### 3.3 Installation procedure

(1) Open the instrument packing box, take out the instrument, check whether the instrument shell and accessories are obviously damaged, and whether the accessories are complete (back of the manual).

(2) Insert the power cord into the instrument power input socket, and insert the power cord plug into the wall plug or plug board with electricity. Note: Ensure that each plug is securely connected to the instrument jack to avoid poor contact.

## 4. Operation Instructions

### 4.1 ON and OFF

#### 4.1.1 Switch ON

After the installation is complete according to the requirements in Chapter 3 of the manual, check that the power switch on, and plug the power plug into the power socket (100-240VAC). Press the power button to turn on the machine.

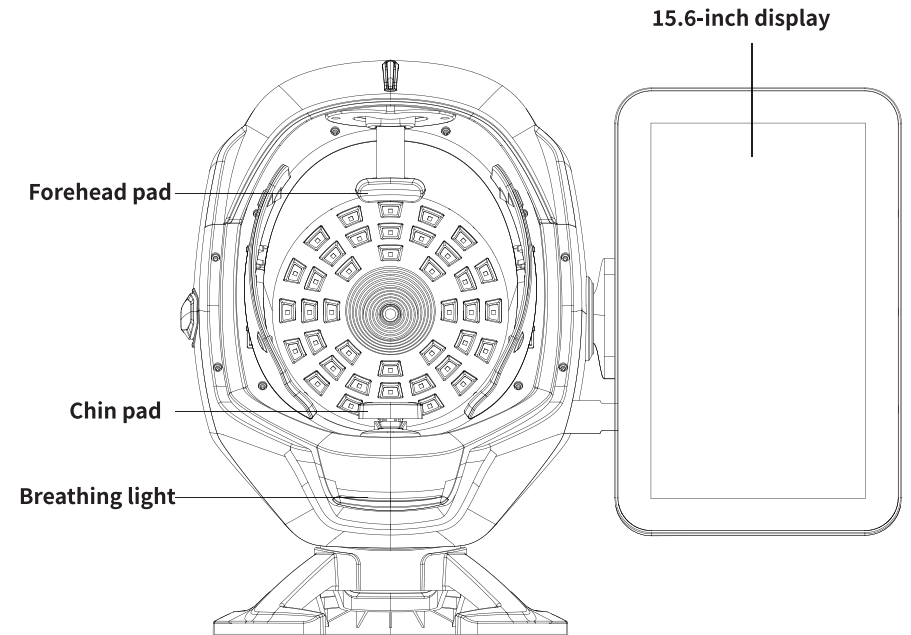
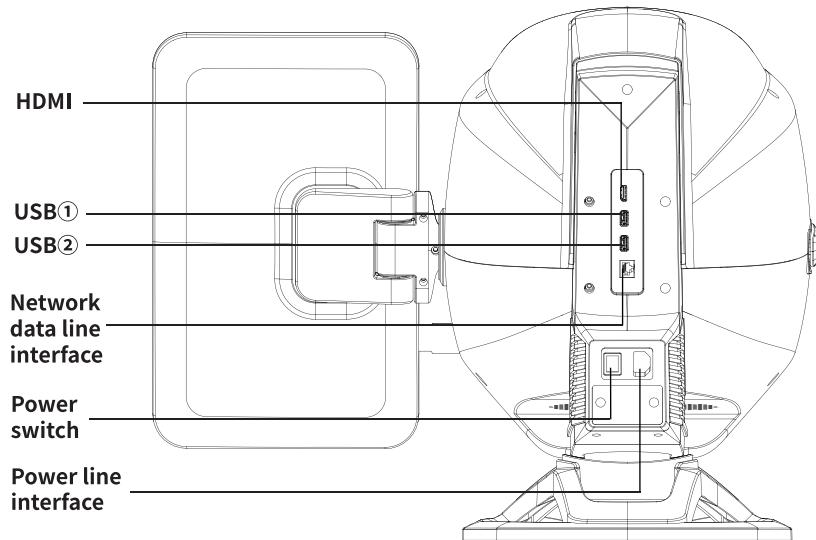

**Warning:**

Ensure that the external connecting wires of the equipment are connected correctly and firmly, and do not remove the grounding wire of the equipment for any reason



### 4.1.2 Switch OFF

Turn off the power switch to shut down, and unplug the power cord plug.

## 4.2 Instructions for use

### 4.2.1 Function operation instruction

(1) Network Connection: Turn on the machine, swipe down from the top of display screen, long press the WIFI icon, enter into setting page, choose the "Network & Internet" option, then turn on the Wi-Fi switch to connect to the local Wi-Fi network. If there is a network cable onsite, network connection through cable is also workable, just plug network cable into network interface of device.

Note: Swipe up from the bottom of the display screen and click the return key to go back to the main interface.

(2) Activate new device

Enter Institution name, email and obtain verification code from your email, then press "Confirm" to activate new device at first time.

Remark:



- Please select priority language from upper right corner as per your requirement.
  - Real salon name or company name are recommended as "Institution name", it will be easy to remember later.
  - To manage background system and customer file more convenient, please use email of salon owner or manager to activate new machine.
- (3) Intelligent skin testing: Page entry: After successful activation, it will enter the main page of the APP, click "AI Skin detect" to enter the file management page. First time test customers can directly click on the "Create new file" option to enter the "Create new file".
- Create new file: Fill in the member customer name, gender, age, mobile phone number; After filling in the information successfully, click "Save now" to enter the Skin detect.
- Skin detect explore: When taking photos, please put your chin on the chin pad below the instrument and do not exceed the slot in front of the soft support, lean your forehead on the forehead pad above, align with the

middle nose line (the middle nose line can be marked on the interface), ask customers to keep their faces clean when taking photos, and remind the photographer to close their eyes and click to take photos. When taking photos, the light will flash five times to capture the face image, waiting for the image data to be uploaded to the cloud server. If you need to take a picture of the side face, you can click on the right or left face to take a picture, if not, you can choose to skip to the next step.

Comparative analysis:

Click on the button "Comparative analysis" on the screen to compare the images of different skin problems on different dates according to your needs.

## 5. Maintenance and Caring

	<p><b>Warning:</b> The maintenance work of this instrument should be carried out with personnel with after-sales qualifications or maintenance personnel familiar with this instrument. Before maintaining this instrument, the power should be cut off and the power cord unplugged from the power socket. Live maintenance of the equipment may cause personal injury and damage to the instrument.</p>
	<p><b>Attention:</b> The entire cleaning process should prohibit the cleaning solution from flowing into the instrument to prevent electrical leakage or rusting of the USB socket, which can lead to poor contact.</p>

- ① The instrument should be operated by trained personnel, after the instrument is started, shall not leave the post; The main engine and all accessories are regularly checked by full-time personnel to keep them in good condition.
- ② Avoid harmful gases and corrosive liquids flowing into the instrument. Do not allowed water to enter the host to avoid personal injury caused by electrical leakage due to reduced insulation performance.



③ The use environment of the whole machine should be in a dry and ventilated place, and the whole machine should be covered by cloth when not in use.

④ The instrument is prohibited from collision, the inside of the instrument is a precision electronic circuit, do not open it without authorization.

⑤ The instrument should always be kept clean, soft semi-dry cotton balls should be used when cleaning, 75% alcohol should be used for cleaning, and organic solvents such as acetone should be prohibited. Do not allow the cleaning liquid to penetrate into the instrument during cleaning, and do not disinfect it at high temperature.

If the instrument needs continuous storage, it must be powered on the instrument (1-2 hours) maintenance when the continuous storage time reaches 6 months.

	<p><b>Warning:</b> To avoid electric shock, please do not disassemble the instrument yourself.</p>
---	--

## 5.1 Troubleshooting

When the AI intelligent imager fails, it should determine the cause of the possible failure according to the fault phenomenon and take appropriate measures.

If the cause of the fault cannot be found or the fault cannot be eliminated according to the troubleshooting table (Table 2), please contact your dealer's special after-sales maintenance network to solve the problem.

Fault state	Maintenance methods
Can not turn on, turn on no response	<ol style="list-style-type: none"> <li>1. Check whether the power supply is connected</li> <li>2. Check whether the power button is reset</li> </ol>
Photo upload failed	<ol style="list-style-type: none"> <li>1. Wfi network speed problem (can be diagnosed in the setting bar)</li> <li>2. Pose properly for photos</li> </ol>
The calendar time update problem is displayed after startup	<ol style="list-style-type: none"> <li>1. Generally, the machine will automatically update to the latest date within 1-5 minutes</li> <li>2. You can follow the prompts to turn off and then turn on the date switch button</li> </ol>

Table 2 Faults and troubleshooting methods

## 5.2 Maintenance Services

### 5.2.1 Function Operation Application

- Host free warranty for one year, accessories and gifts warranty for 90 days, long-term after-sales maintenance service.
- During the warranty period, users can enjoy unified after-sales service and replacement of warranty parts policy.
- The maintenance must show the valid purchase warranty certificate, the warranty period from the date of purchase, the user loses the valid purchase certificate, the product warranty period is calculated according to the product factory date.
- After repair, the same part, the same fault phenomenon occurs again, free maintenance within 30 days.
- The parts repaired and replaced during the warranty period belong to the after-sales maintenance network, and the parts repaired and replaced outside the warranty period belong to the user.
- Additional services and additional non-original configuration gifts promised by each regional distributor shall be maintained by the distributor.

### 5.2.2 Not Under Warranty

- (1) Accessories and gifts of AI intelligent skin tester (ZMLH-A5).
- (2) The user handling, use, maintenance, storage of improper damage.
- (3) The use voltage is less than 100 volts or higher than 240 volts and damaged.
- (4) Failure to use, maintain and maintain the product according to the requirements of the manual and cause damage.
- (5) Disassembly and maintenance by non-relevant after-sales service personnel.
- (6) Without the permission of the company, the use of accessories and products provided by non-relevant after-sales service personnel, resulting in instrument damage or other.
- (7) Damage caused by irresistible force (such as lightning, fire, earthquake, flood and other natural disasters).
- (8) The product exceeds the warranty period.
- (9) The model number or number recorded on the invoice or warranty card does not conform to the physical product.

In the above cases, the relevant after-sales service personnel will implement charging maintenance, and the cost types include maintenance fees, spare parts fees, and on-site fees, and the specific cost standards are within the scope of the relevant departments' permission.

### 5.2.3 Warranty Card

Name		Tel		Zip code	
Address					
Model No	ZMLH-A5	Host code			
Company Name			Purchasing date		

Maintenance Records				
Date	Fault Description	Handling Method	Tel	Maintenance personnel

**Remarks:**

- Please fill out this warranty card immediately when purchasing the product
- Keep the warranty card properly
- Please bring valid institutional credentials when repairing

FCC Warning:

This equipment has been tested and found to comply with the limits for a Class B digital device, pursuant to part 15 of the FCC Rules. These limits are designed to provide reasonable protection against harmful interference in a residential installation. This equipment generates, uses and can radiate radio frequency energy and, if not installed and used in accordance with the instructions, may cause harmful interference to radio communications. However, there is no guarantee that interference will not occur in a particular installation. If this equipment does cause harmful interference to radio or television reception, which can be determined by turning the equipment off and on, the user is encouraged to try to correct the interference by one or more of the following measures:

- Reorient or relocate the receiving antenna.
- Increase the separation between the equipment and receiver.
- Connect the equipment into an outlet on a circuit different from that to which the receiver is connected.
- Consult the dealer or an experienced radio/TV technician for help.

Caution: Any changes or modifications to this device not explicitly approved by manufacturer could void your authority to operate this equipment.

This device complies with part 15 of the FCC Rules. Operation is subject to the following two conditions:

(1) This device may not cause harmful interference, and (2) this device must accept any interference received, including interference that may cause undesired operation.

This equipment complies with FCC radiation exposure limits set forth for an uncontrolled environment. This equipment should be installed and operated with minimum distance 0cm between the radiator and your body.