

## Nemko Korea Co., Ltd.

165-51, Yurim-ro, Cheoin-gu, Yongin-si, Gyeonggi-do, 17042, Republic of Korea  
TEL:+82 31 330-1700 FAX:+82 31 322 2332

### FCC & IC EVALUATION REPORT FOR CERTIFICATION

<b>Project No. :</b> NK-23-R-451	<b>Dates of receipt :</b> May 8, 2024
<b>Applicant :</b> COWAY.CO., Ltd. 136-23, Yugumagoksa-ro, Yugu-eup, Gongju-si, Chungcheongnam-do, Korea, Republic of	<b>Dates of Issue :</b> August 29, 2024
	<b>Test Site :</b> Nemko Korea Co., Ltd.

<b>FCC ID :</b>	<b>2BGKD-BIDETMEGA500S</b>
<b>IC :</b>	<b>32509-BMEGA500S</b>
<b>FCC Applicant :</b>	<b>Coway USA INC.</b>
<b>IC Applicant :</b>	<b>COWAY Co.,Ltd</b>
<b>Brand Name :</b>	<b>COWAY</b>

<b>Model:</b>	<b>BIDETMEGA 500S(E)</b>
<b>Additional Model(s):</b>	<b>BIDETMEGA 500S(R), BIDETMEGA 400S(E), BIDETMEGA 400S(R), BA42-AEUS, BA42-ARUS</b>
<b>EUT Type:</b>	<b>Electric Bidet</b>
<b>Classification:</b>	<b>FCC Part 15 Digital Transmission System (DTS)</b>
<b>Date of Test:</b>	<b>May 27, 2024 ~ June 12, 2024</b>
<b>Applied Standard:</b>	<b>FCC 47 CFR Part 15.247 RSS-Gen Issue 5, RSS-247 Issue 3</b>

The device bearing the brand name and model specified above has been shown to comply with the applicable technical standards as indicated in the measurement report and was tested in accordance with the measurement procedures specified in ANSI C63.10-2013. The client should not use it to claim product endorsement by TAF or any government agencies. The test results in the report only apply to the tested sample.

I attest to the accuracy of data and all measurements reported herein were performed by me or were made under my supervision and are correct to the best of my knowledge and belief. I assume full responsibility for the completeness of these measurements and vouch for the qualifications of all persons taking them.



Tested By : Yonghwan Kim  
Test Engineer

Reviewed By : Hoonpyo Lee  
Technical Manager

**Revision History**

Rev.	Issue Date	Revisions	Revised By
00	August 29, 2024	Initial issue	Yonghwan Kim

# TABLE OF CONTENTS

<b>1. INTRODUCTION .....</b>	<b>4</b>
1.1 Test facility .....	4
1.2 Accreditation and listing .....	4
<b>2. EUT INFORMATION &amp; TEST CONDITIONS.....</b>	<b>5</b>
2.1 EUT Information .....	5
2.2 Operation During Test.....	6
2.3 Support Equipment .....	8
2.4 Setup Drawing.....	9
<b>3. ANTENNA REQUIREMENTS .....</b>	<b>10</b>
<b>4. SUMMARY OF TEST RESULTS .....</b>	<b>11</b>
<b>5. TEST METHODOLOGY .....</b>	<b>11</b>
<b>6. DESCRIPTION OF TESTS .....</b>	<b>12</b>
6.1 6 dB Bandwidth / Occupied Bandwidth.....	12
6.2 Peak Output Power .....	13
6.3 Power Spectral Density.....	14
6.4 Band Edge / Conducted Spurious Emissions .....	15
6.5 Radiated Emissions .....	16
6.6 AC Line Conducted Emissions.....	17
<b>7. TEST DATA .....</b>	<b>18</b>
7.1 6 dB Bandwidth / Occupied Bandwidth.....	18
7.2 Peak Output Power .....	21
7.3 Power Spectral Density.....	23
7.4 Band Edge / Conducted Spurious Emissions .....	25
7.5 Radiated Spurious Emissions .....	29
7.6 Radiated Band Edge .....	34
7.7 Radiated Emissions_Below 1GHz .....	36
7.8 AC Line Conducted .....	38
<b>8. TEST EQUIPMENT .....</b>	<b>40</b>
<b>9. ACCURACY OF MEASUREMENT &amp; DECISION RULE .....</b>	<b>41</b>
9.1 Uncertainty Calculation .....	41
9.2 Decision rule.....	41







# **1. INTRODUCTION**

## **1.1 Test facility**

The measurement procedure described in American National Standard for Methods of Measurement of Radio-Noise Emissions from Low-Voltage Electrical and Electronic Equipment in the Range of 9 kHz to 40 GHz (ANSI C63.4-2014), the American National Standard for Testing Unlicensed Wireless Devices (ANSI C63.10-2013) was used in determining radiated and conducted emissions emanating.

These measurement tests were conducted at **Nemko Korea Co., Ltd.**  
The site address 165-51, Yurim-ro, Cheoin-gu, Yongin-si, Gyeonggi-do, 17042, Rep. of Korea.

## **1.2 Accreditation and listing**

	Accreditation type	Accreditation number
	CAB Accreditation for DOC	Designation No. KR0026
	KOLAS Accredited Lab. (Korea Laboratory Accreditation Scheme)	Registration No. KT155
	Canada IC Registered site	Site No. 29506
	VCCI registration site(RE/CE/Telecom CE)	Member No. 2118
	EMC CBTL	TL124
	KCC(RRL)Designated Lab.	Registration No. KR0026

## **2. EUT INFORMATION & TEST CONDITIONS**

### **2.1 EUT Information**

#### **2.1.1 Specifications**

EUT Type	Electric Bidet
Model Name	BIDETMEGA 500S(E)
Additional Model(s)	BIDETMEGA 500S(R), BIDETMEGA 400S(E), BIDETMEGA 400S(R), BA42-AEUS, BA42-ARUS
Frequency of Operation	2 402 MHz ~ 2 480 MHz
Peak Output Power (Conducted)	3.86 dBm
Number of Channels	40 CH
Modulations	GFSK (Bluetooth LE 1Mbps)
Antenna Gain (peak)	1.6 dBi
Antenna Setup	1TX / 1RX
EUT Rated Voltage	AC 120 V, 60 Hz
EUT Test Voltage	AC 120 V, 60 Hz
Remarks	-

## 2.2 Operation During Test

The EUT is the transceiver which is Bluetooth v5.2 supporting Bluetooth LE mode(1Mbps). The Laptop PC was used to control the EUT to transmit the wanted TX channel continuously (duty cycle > 98%) by the testing program.

The EUT was tested at the lowest, middle and the highest channels with the maximum output power in accordance with the manufacturer’s specifications. The worst data were recorded in the report.

### 2.2.1 Table of Test power setting

Frequency	Mode	Modulation	Power setting Level
2 402 MHz ~ 2 480 MHz	BLE 1Mbps	GFSK	4

### 2.2.2 Table of Test frequency

Frequency band	Modulation	Test Channel (CH)	Frequency (MHz)
2.4 GHz	GFSK	0	2 402
		19	2 440
		39	2 480

### 2.2.3 Average Output Power

Mode	Frequency	Average Output Power (dBm)	Antenna Gain (dBi)	e.i.r.p (dBm)
Bluetooth LE 1Mbps	2 402	3.33	1.6	4.93
	2 440	3.04		4.64
	2 480	2.82		4.42

**2.2.4 Antenna Information**

Frequency band	Modulation	Antenna TX mode	Support CDD	Support MIMO
2.4 GHz	GFSK	<input checked="" type="checkbox"/> 1TX, <input type="checkbox"/> 2TX	<input type="checkbox"/> Yes, <input checked="" type="checkbox"/> No	<input type="checkbox"/> Yes, <input checked="" type="checkbox"/> No

**2.2.5 Additional Information Related to Testing**

The cable and attenuator loss from 30 MHz to 26.5 GHz was reflected in spectrum analyzer with correction factor for all conducted testing.

**2.2.6 Worst-case Configuration and Mode**

Radiated emission below 1GHz was performed with the EUT set to transmit at the channel with highest output power as worst-case scenario.

Radiated emission above 1GHz was performed with the EUT set to transmit low/mid/high channels.

**2.2.7 Additional model covered by this report**

- The variant models shall use materials and electric circuits that are the same as the basic model.
- The difference between basic and variant models are as below table.

Variant model name	Description
BIDETMEGA 500S(R)	1. The shape of the toilet seat is different.
BIDETMEGA 400S(E)	1. Delete deodorization function 2. Delete open/close function 3. Delete mood LED
BIDETMEGA 400S(R)	1. Delete deodorization function 2. Delete open/close function 3. Delete mood LED 4. The shape of the toilet seat is different
BA42-AEUS	1. Delete UV-C LED 2. Delete mood LED
BA42-ARUS	1. Delete UV-C LED 2. Delete mood LED 3. The shape of the toilet seat is different

**2.3 Support Equipment**

EUT	COWAY.CO., Ltd. Model : BIDETMEGA 500S(E)	S/N: N/A
Laptop Computer	HP Model : G62-355TU	FCC DOC S/N : CNF0489WDT
AC Adapter	HP Model : PPP009D	FCC DOC S/N : WBGSV0ACXZH162



## 2.4 Setup Drawing

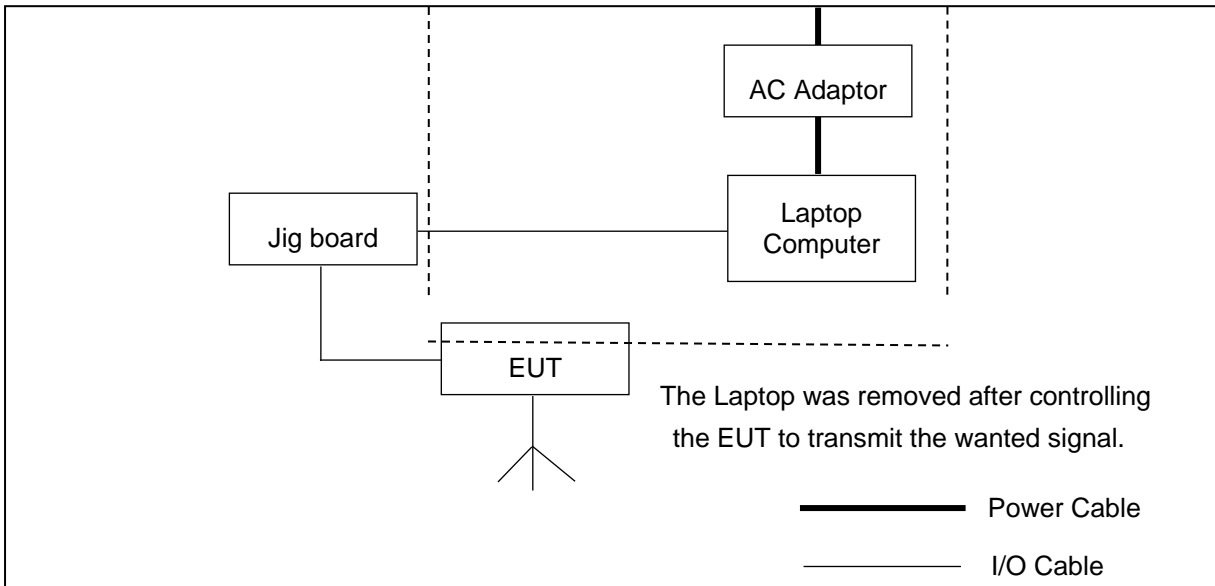

### **3. ANTENNA REQUIREMENTS**

Measurement and determination of electromagnetic emissions (EME) of radio frequency devices including intentional and/or unintentional radiators for compliance with the technical rules and regulations of the Federal Communications Commission under FCC part 15 and RSS-Gen.

§15.203 of the FCC Rules part 15 Subpart C

: An intentional radiator shall be designed to ensure that no antenna other than that furnished by the responsible party shall be used with the device. The use of a permanently attached antenna or of an antenna that uses a unique coupling to the intentional radiator shall be considered sufficient to comply with the provisions of this section.

RSS-Gen Section 6.8

: The applicant for equipment certification shall provide a list of all antenna types that may be used with the transmitter, where applicable (i.e. for transmitters with detachable antenna), indicating the maximum permissible antenna gain (in dBi) and the required impedance for each antenna. The test report shall demonstrate the compliance of the transmitter with the limit for maximum equivalent isotropically radiated power (e.i.r.p.) specified in the applicable RSS, when the transmitter is equipped with any antenna type, selected from this list.

For expediting the testing, measurements may be performed using only the antenna with highest gain of each combination of transmitter and antenna type, with the transmitter output power set at the maximum level. However, the transmitter shall comply with the applicable requirements under all operational conditions and when in combination with any type of antenna from the list provided in the test report (and in the notice to be included in the user manual, provided below)

The test report shall state the RF power, output power setting and spurious emission measurements with each antenna type that is used with the transmitter being tested.

Immediately following the above notice, the manufacturer shall provide a list of all antenna types which can be used with the transmitter, indicating the maximum permissible antenna gain (in dBi) and the required impedance for each antenna type.

The transmitter has permanently attached Chip antenna (Internal antenna) on board.

Used Antenna	
Model name	2 402 MHz ~ 2 480 MHz
	Max. peak gain (dBi)
BA42-ARUS	1.6

## **4. SUMMARY OF TEST RESULTS**

The EUT has been tested according to the following specification:

Name of Test	FCC Paragraph No.	IC Paragraph No.	Test Limit	Test Condition	Result	Remark
6dB Bandwidth	15.247(a)(2)	RSS-247 (5.2)(a)	> 500 kHz	Conducted	Complies	-
Occupied Bandwidth	-	RSS-Gen (6.7)				
Peak Output Power	15.247(b)(3)	RSS-247 (5.4)(d)	< 1 Watt < 4 Watt(e.i.r.p.)		Complies	-
Power Spectral Density	15.247(e)	RSS-247 (5.2)(b)	< 8 dBm/3 kHz		Complies	-
Band Edge / Conducted Spurious Emission	15.247(d)	RSS-247 (5.5)	≥ 20 dBc		Complies	-
Radiated Spurious Emission	15.205, 15.209	RSS-Gen (8.9),(8.10)	< 74 dBμV/m (PK) < 54 dBμV/m (AV) Radiated limits detailed in 15.209	Radiated	Complies	-
AC Line Conducted Emission	15.207	RSS-Gen (8.8)	FCC 15.207 Limits	Line Conducted	Complies	-

## **5. TEST METHODOLOGY**

1. FCC CFR 47 Part 2.
2. FCC CFR 47 Part 15.
3. KDB 558074 D01 15.247 Meas Guidance v05r02.
4. RSS-Gen Issue 5
5. RSS-247 Issue 3
6. ANSI C63.10-2013.

## **6. DESCRIPTION OF TESTS**

### **6.1 6 dB Bandwidth / Occupied Bandwidth**

#### **Test Setup**

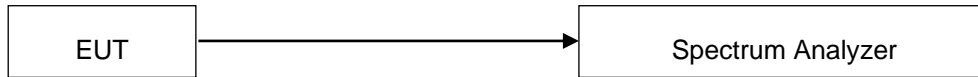

#### **Test Measurement Method**

ANSI C63.10-2013, Section 11.8.2 Option 2  
KDB 558074 D01 v05r02, Section 8.2  
RSS-Gen section 6.7

#### **Test Procedure**

##### **- 6 dB Bandwidth (DTS Chanel Bandwidth)**

EUTs 6 dB bandwidth is measured at low, middle, high channels with a spectrum analyzer connected to the antenna terminal while the EUTs operating at its maximum power control level. The spectrum analyzer setting is as follows.

RBW = 100 kHz

VBW > 3 x RBW

Detector = Peak

Trace mode = max hold

Sweep = auto couple

Allow trace to fully stabilize.

The bandwidth measurement function on the spectrum analyzer is used to measure the 6 dB bandwidth.

##### **- Occupied Bandwidth**

EUTs occupied bandwidth is measured at low, middle, high channels with a spectrum analyzer connected to the antenna terminal while the EUTs operating at its maximum power control level. The spectrum analyzer setting is as follows.

Span = Set large enough to capture all products of the modulation process, including the emission skirts, around the carrier frequency, but small enough to avoid having other emissions (e.g. on adjacent channels) within the span.

Detector = Set to "Sample". However, a peak, or peak hold, may be used in place of the sampling detector since this usually produces a wider bandwidth than the actual bandwidth (worst-case measurement). Use of a peak hold (or "Max Hold") may be necessary to determine the occupied / x dB bandwidth if the device is not transmitting continuously.

RBW = 1% to 5% of the actual occupied / x dB bandwidth

VBW > 3 x RBW, Video averaging is not permitted.

Note: It may be necessary to repeat the measurement a few times until the RBW and VBW are in compliance with the above requirement.

## 6.2 Peak Output Power

### Test Setup

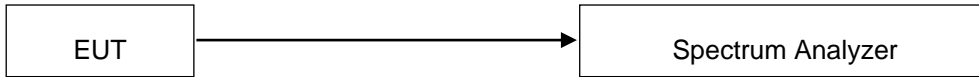

### Test Measurement Method

ANSI C63.10-2013, Section 11.9.1.1  
KDB 558074 D01 v05r02, Section 8.3.1.1

### Test Procedure

EUTs Maximum Peak Conducted Output Power is measured at low, middle, high channels with a spectrum analyzer connected to the antenna terminal while the EUTs operating at its maximum power control level.

The spectrum analyzer setting is as follows.

RBW  $\geq$  DTS bandwidth

VBW  $\geq$  3 x RBW

Span  $\geq$  3 x RBW

Sweep time = auto couple

Detector = peak

Trace mode = max hold

Allow trace to fully stabilize.

Use peak marker function to determine the peak amplitude level.

## 6.3 Power Spectral Density

### Test Setup

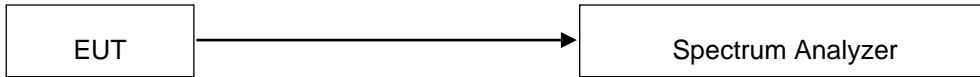

### Test Measurement Method

ANSI C63.10-2013, Section 11.10.2 Method PKPSD  
KDB 558074 D01 v05r02, Section 8.4

### Test Procedure

EUTs Power Spectral Density is measured at low, middle, high channels with a spectrum analyzer connected to the antenna terminal while the EUTs operating at its maximum power control level.

The spectrum analyzer setting is as follows.

Center frequency = DTS channel center frequency

Span = 1.5 times the DTS channel bandwidth

RBW  $\geq$  3 kHz

VBW  $\geq$  3 x RBW

Detector = peak

Sweep time = auto couple

Trace mode = max hold

Allow the trace to stabilize.

The peak search function on the spectrum analyzer is used to determine the maximum amplitude level within the RBW.

## 6.4 Band Edge / Conducted Spurious Emissions

### Test Setup

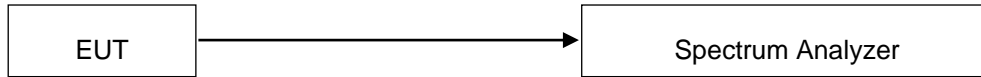

### Test Measurement Method

ANSI C63.10-2013, Section 11.11.3  
KDB 558074 D01 v05r02, Section 8.5, Section 8.7.2

### Test Procedure

EUTs Conducted spurious emissions are measured at low, middle, high channels with a spectrum analyzer connected to the antenna terminal while the EUTs operating at its maximum power control level. The spectrum analyzer setting is as follows.

#### 1) Reference Level

Center frequency = DTS channel center frequency

Span  $\geq 1.5 \times$  DTS bandwidth

RBW = 100 kHz

VBW  $\geq 3 \times$  RBW

Detector = peak

Sweep time = auto couple

Trace mode = max hold

Allow trace to fully stabilize.

Use the peak marker function to determine the maximum PSD level.

Note that the channel found to contain the maximum PSD level can be used to establish the reference level.

#### 2) Unwanted Emissions

Set the center frequency and span to encompass frequency range to be measured.

RBW = 100 kHz

VBW  $\geq 3 \times$  RBW

Detector = peak

Sweep time = auto couple

Trace mode = max hold

Allow trace to fully stabilize.

Use the peak marker function to determine the maximum amplitude level.

## 6.5 Radiated Emissions

### Test Measurement Method

ANSI C63.10-2013, Section 6.6.4.3, Section 11.11, Section 11.12  
KDB 558074 D01 v05r02, Section 8.6, Section 8.7

### Test Procedure

The measurement was performed at the test site that is specified in accordance with ANSI C63.10-2013.

The spurious emission was scanned from 9 kHz to 30 MHz using Loop Antenna and 30 to 1000 MHz using Trilog broadband test antenna. Above 1 GHz, Horn antenna was used.

For emissions testing at below 1GHz, The test equipment was placed on turntable with 0.8 m above ground. For emission measurements above 1 GHz, The test equipment was placed on turntable with 1.5 m above ground. Sufficient time for the EUT, support equipment, and test equipment was allowed in order for them to warm up to their normal operating condition. The EUT, cable, wire arrangement and mode of operation that has the highest amplitude relative to the limit was selected. Then, the turn table was rotated from 0° to 360° and an antenna mast was moved from 1 m to 4 m height to maximize the suspected highest amplitude signal. The final maximized level was recorded.

At frequencies below 1000 MHz, measurements performed using the CISPR quasi-peak detection. At frequencies above 1000 MHz, measurements performed using the peak and average measurement procedures described in ANSI 63.10-2013 section 11.12. Peak emission levels were measured by setting the analyzer RBW = 1 MHz, VBW = 3 MHz, Detector = Peak, Trace mode = max hold. Average emission levels were measured by setting the analyzer RBW = 1 MHz, VBW = 10 kHz, Detector = Peak, Trace mode = max hold. Allow max hold to run for at least 50 times (1/duty cycle) traces.

Frequency (MHz)	Field strength (microvolts/meter)	Measurement distance (meters)
0.009–0.490	2400/F(kHz)	300
0.490–1.705	24000/F(kHz)	30
1.705–30.0	30	30
30–88	100	3
88–216	150	3
216–960	200	3
Above 960	500	3

Radiated Emissions Limits per 47 CFR 15.209(a) & RSS-Gen (8.9)



## 6.6 AC Line Conducted Emissions

### Test Measurement Method

ANSI C63.10-2013, Section 6.2

### Test Procedure

The Line conducted emission test facility is located inside a 4 x 7 x 2.5 meter shielded enclosure. It is manufactured by EM engineering. The shielding effectiveness of the shielded room is in accordance with MIL-STD-285 or NSA 65-6. A 1 m x 1.5 m wooden table 0.8 m height is placed 0.4 m away from the vertical wall and 1.5 m away from the side of wall of the shielded room. Rohde & Schwarz (ENV216) of the 50 ohm/50  $\mu$ H Line Impedance Stabilization Network (LISN) are bonded to the shielded room. The EUT is powered from the Rohde & Schwarz LISN. Power to the LISNs are filtered by high-current high insertion loss Power line filters. The purpose of filter is to attenuate ambient signal interference and this filter is also bonded to shielded enclosure. All electrical cables are shielded by tinned copper zipper tubing with inner diameter of 1 / 2 ". If DC power device, power will be derived from the source power supply it normally will be powered from and this supply lines will be connected to the LISNs, All interconnecting cables more than 1 meter were shortened by non-inductive bundling (serpentine fashion) to a 1 meter length. Sufficient time for EUT, support equipment, and test equipment was allowed in order for them to warm up to their normal operating condition. The RF output of the LISN was connected to the spectrum analyzer to determine the frequency producing the maximum EME from the EUT. The spectrum was scanned from 150 kHz to 30 MHz with 200 msec sweep time. The frequency producing the maximum level was re-examined using the EMI test receiver. (Rohde & Schwarz ESCI). The detector functions were set to CISPR quasi-peak mode & average mode. The bandwidth of receiver was set to 9 kHz. The EUT, support equipment, and interconnecting cables were arranged and manipulated to maximize each EME emission. Each emission was maximized by; switching power lines; varying the mode of operation or resolution; clock or data exchange speed; scrolling H pattern to the EUT and of support equipment, and powering the monitor from the floor mounted outlet box and computer aux AC outlet, if applicable; whichever determined the worst case emission.

Each EME reported was calibrated using the R&S signal generator.

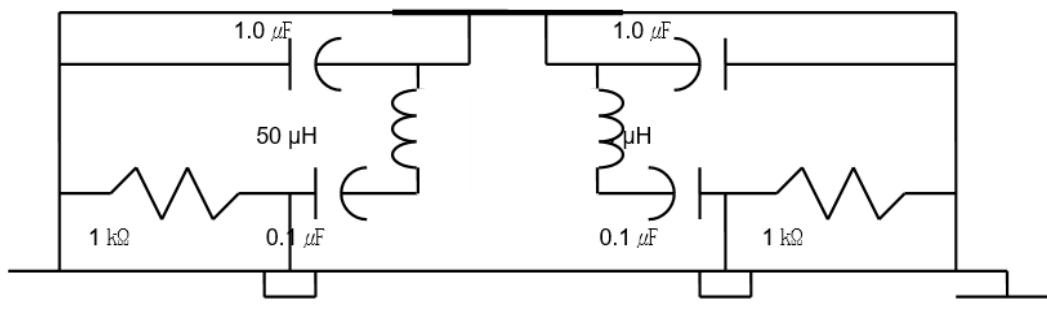

Fig. 2. LISN Schematic Diagram

## **7. TEST DATA**

### **7.1 6 dB Bandwidth / Occupied Bandwidth**

FCC §15.247(a)(2)  
RSS-247 (5.2)(a), RSS-Gen (6.7)

Test Mode : Set to Lowest channel, Middle channel and Highest channel

#### **Result**

##### **- 6 dB Bandwidth**

Bluetooth Mode & Data Rate	Channel No.	Frequency (MHz)	6 dB Bandwidth (MHz)	Minimum Bandwidth Limit (kHz)
LE 1Mbps	0	2 402	0.720	500
	19	2 440	0.726	500
	39	2 480	0.732	500

##### **- Occupied Bandwidth**

Bluetooth Mode & Data Rate	Channel No.	Frequency (MHz)	Occupied Bandwidth (MHz)	Limit (MHz)
LE 1Mbps	0	2 402	1.066	-
	19	2 440	1.057	-
	39	2 480	1.070	-

## PLOTS OF EMISSIONS

### 6 dB Bandwidth, Lowest Channel (2 402 MHz)

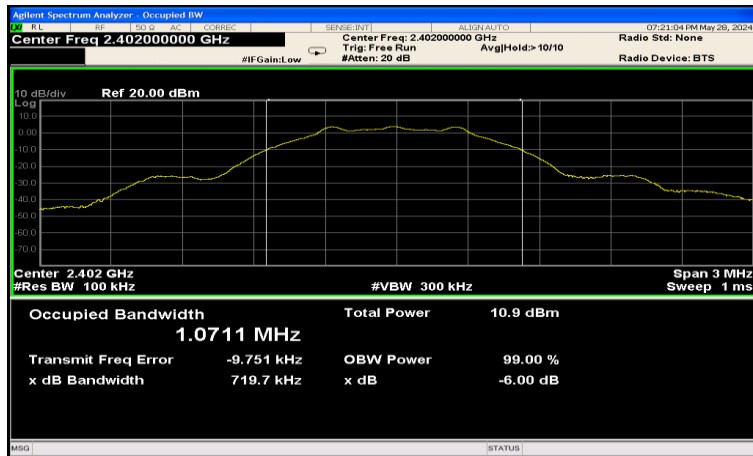

### 6 dB Bandwidth, Middle Channel (2 440 MHz)

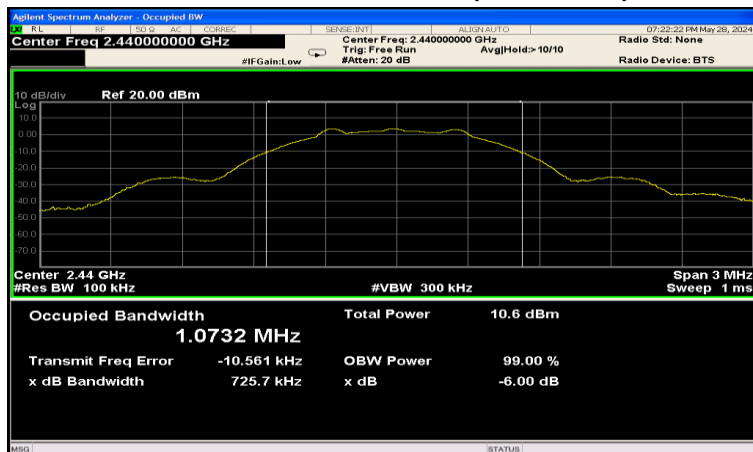

### 6 dB Bandwidth, Highest Channel (2 480 MHz)

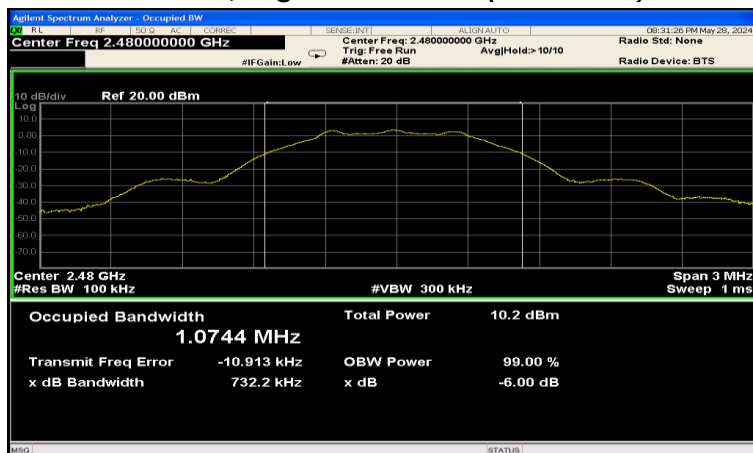

### Occupied Bandwidth, Lowest Channel (2 402 MHz)

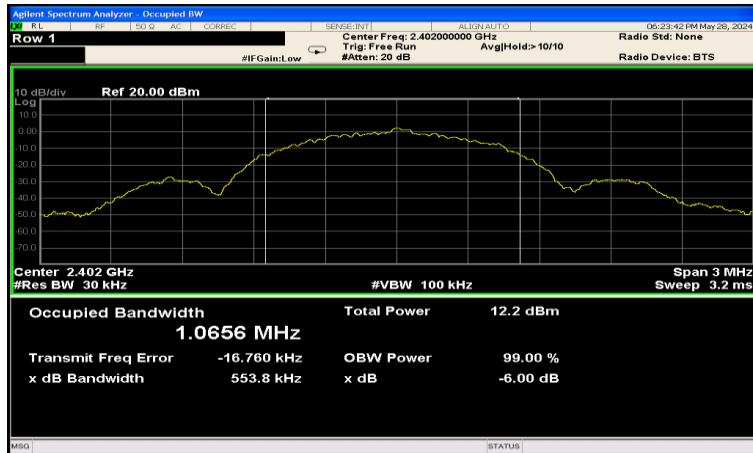

### Occupied Bandwidth, Middle Channel (2 440 MHz)

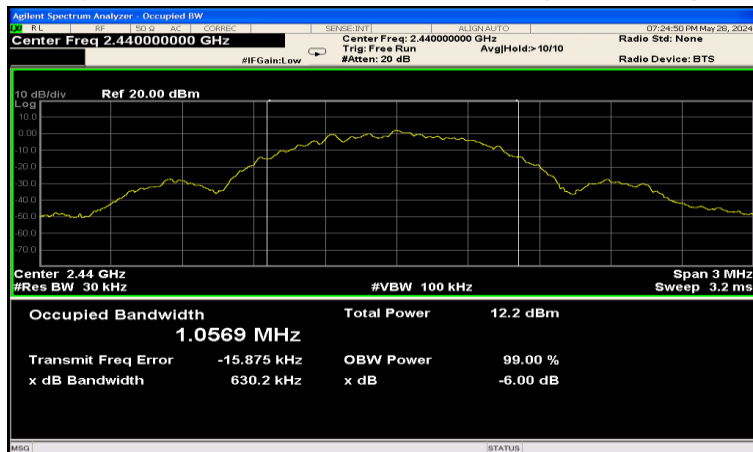

### Occupied Bandwidth, Highest Channel (2 480 MHz)

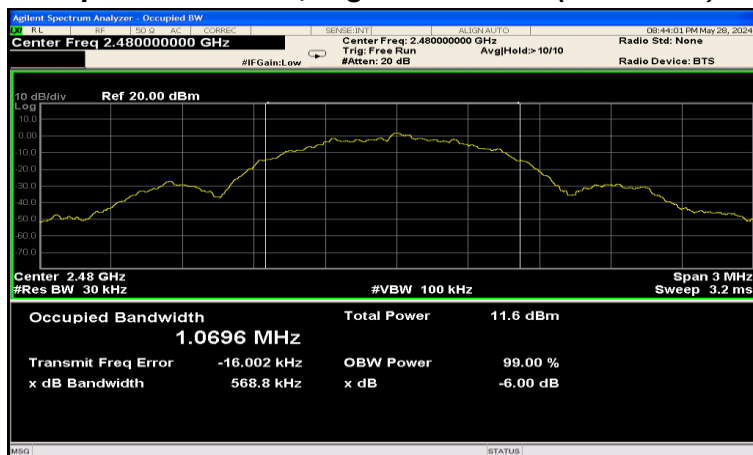

## 7.2 Peak Output Power

FCC §15.247(b)(3)  
RSS-247(5.4)(d)

Test Mode : Set to Lowest channel, Middle channel and Highest channel

### Result

Bluetooth Mode & Data Rate	Frequency (MHz)	Peak Output Power (dBm)	Limit (dBm)	Antenna Gain (dBi)	e.i.r.p. (dBm)	Limit (dBm)
LE 1Mbps	2 402	3.86	30.00	1.6	5.46	36.00
	2 440	3.62	30.00		5.22	36.00
	2 480	3.37	30.00		4.97	36.00

### Notes:

- The following equation was used for spectrum offset:  
Spectrum offset (dB) = Attenuator (dB) + Cable Loss (dB) + SMA Type Connector Loss (dB)
- The following equation was used for e.i.r.p. calculation:  
e.i.r.p. (dBm) = Peak output power (dBm) + Antenna gain (dBi)

## PLOTS OF EMISSIONS

**Peak Output Power, Lowest Channel (2 402 MHz)**

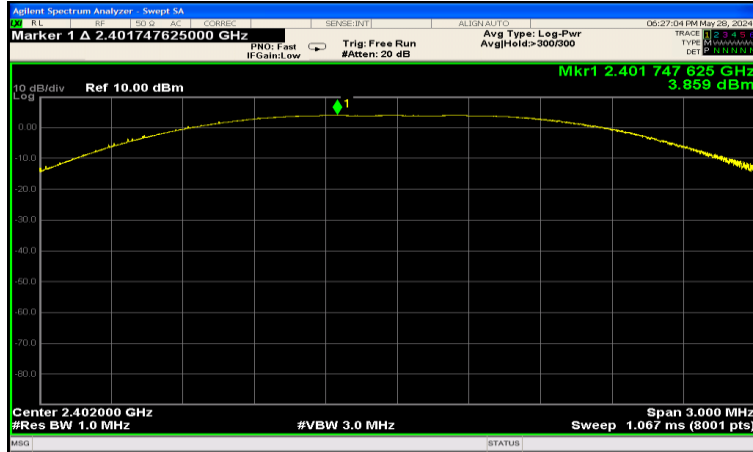

**Peak Output Power, Middle Channel (2 440 MHz)**

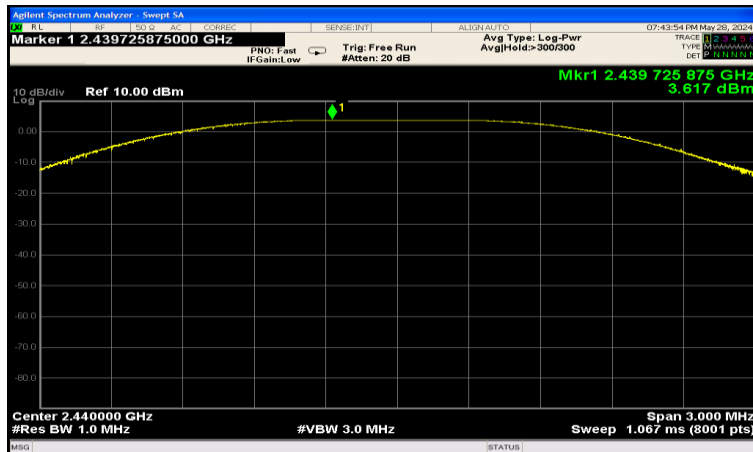

**Peak Output Power, Highest Channel (2 480 MHz)**

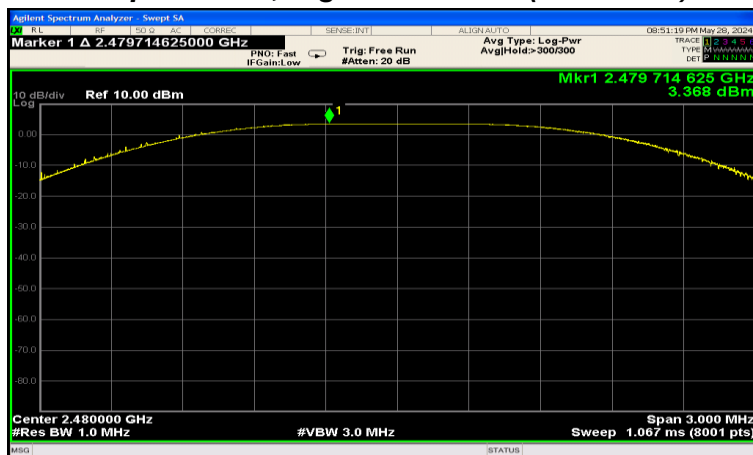

### 7.3 Power Spectral Density

FCC §15.247(e)  
RSS-247(5.2)(b)

Test Mode : Set to Lowest channel, Middle channel and Highest channel

**Result**

Bluetooth Mode & Data Rate	Channel No.	Frequency (MHz)	Measured PSD (dBm/3kHz)	PSD Limit (dBm/3kHz)	Margin (dB)
LE 1Mbps	0	2 402	-9.04	8.00	17.04
	19	2 440	-9.79	8.00	17.79
	39	2 480	-9.07	8.00	17.07

**Notes:**

1. The following equation was used for spectrum offset:

$$\text{Spectrum offset (dB)} = \text{Attenuator (dB)} + \text{Cable Loss (dB)} + \text{SMA Type Connector Loss (dB)}$$

## PLOTS OF EMISSIONS

**Power Spectral Density, Lowest Channel (2 402 MHz)**

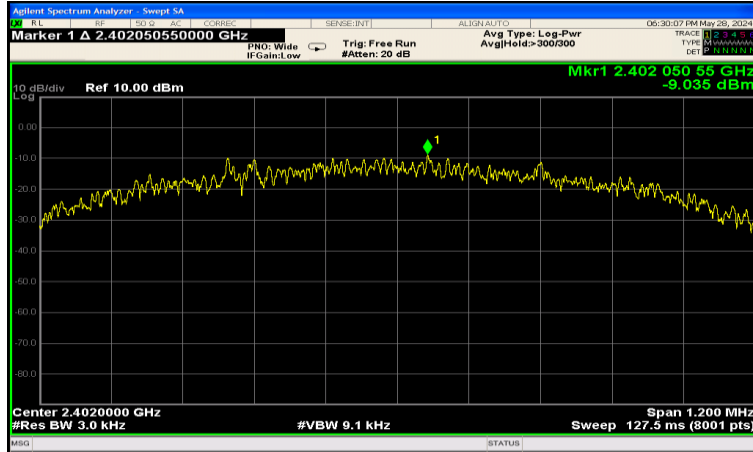

**Power Spectral Density, Middle Channel (2 440 MHz)**

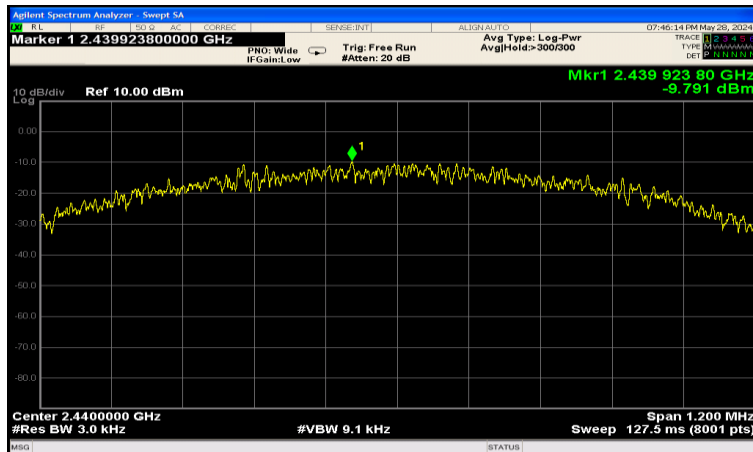

**Power Spectral Density, Highest Channel (2 480 MHz)**

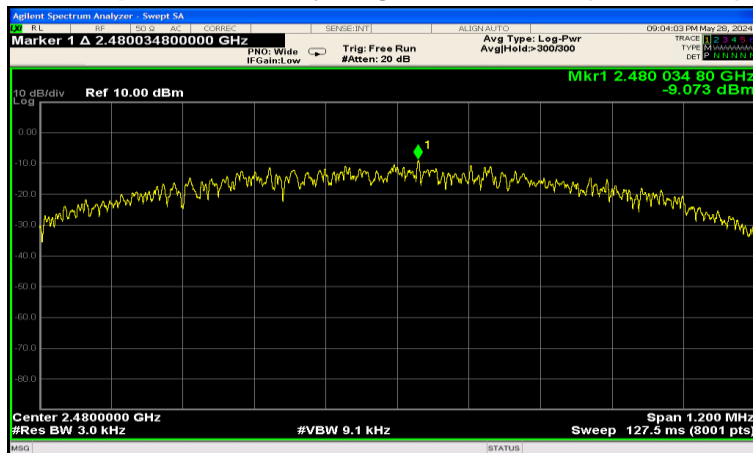



## 7.4 Band Edge / Conducted Spurious Emissions

FCC §15.247(d)  
RSS-247(5.5)

Test Mode : Set to Lowest channel, Middle channel and Highest channel

### Result

Bluetooth Mode & Data Rate	Channel No.	Frequency (MHz)	Conducted Spurious Emissions (dBc)	Limit (dBc)
LE 1Mbps	0	2 402	More than 20 dBc	20
	19	2 440	More than 20 dBc	20
	39	2 480	More than 20 dBc	20

### Notes:

The cable and attenuator loss from 30 MHz to 26.5 GHz was reflected in spectrum analyzer with correction factor for the spurious emissions test.

## PLOTS OF EMISSIONS

Reference Level, Lowest Channel (2 402 MHz)

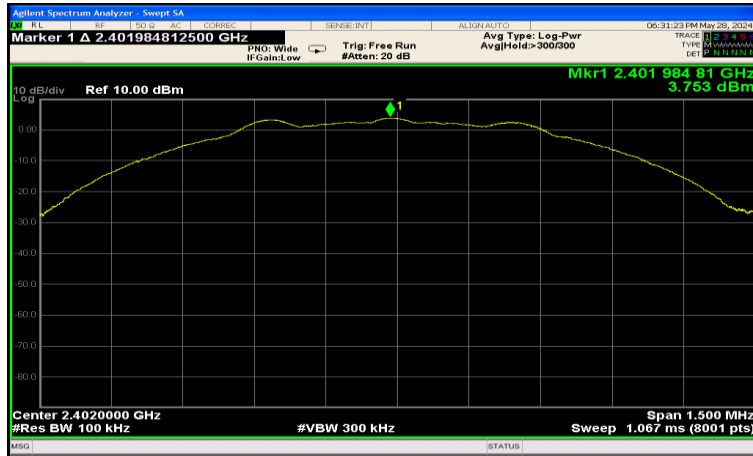

Band Edge, Lowest Channel (2 402 MHz)

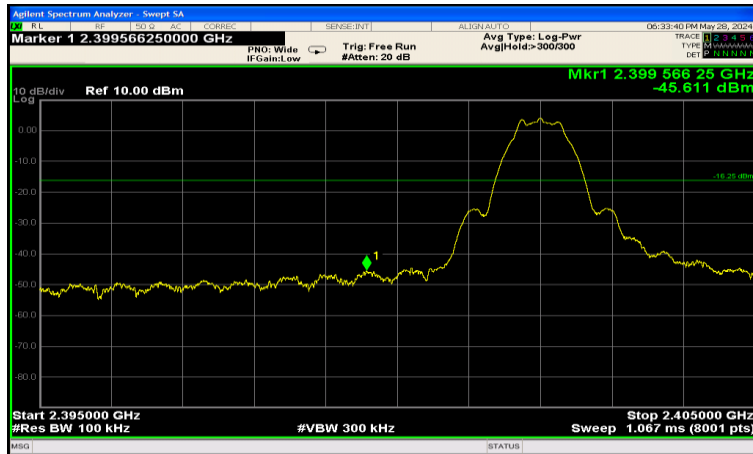

Conducted Spurious Emissions, Lowest Channel (2 402 MHz)

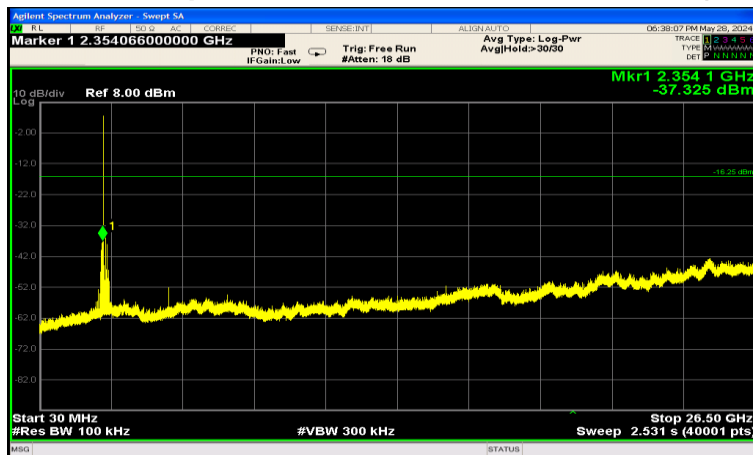

**Reference Level, Middle Channel (2 440 MHz)**

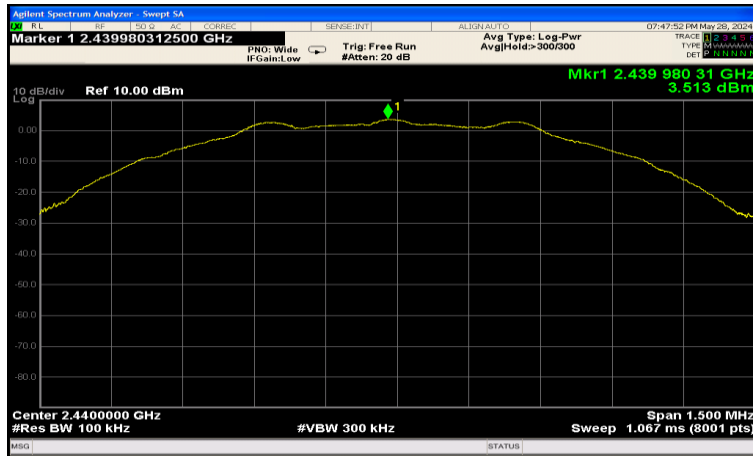

**Conducted Spurious Emissions, Middle Channel (2 440 MHz)**

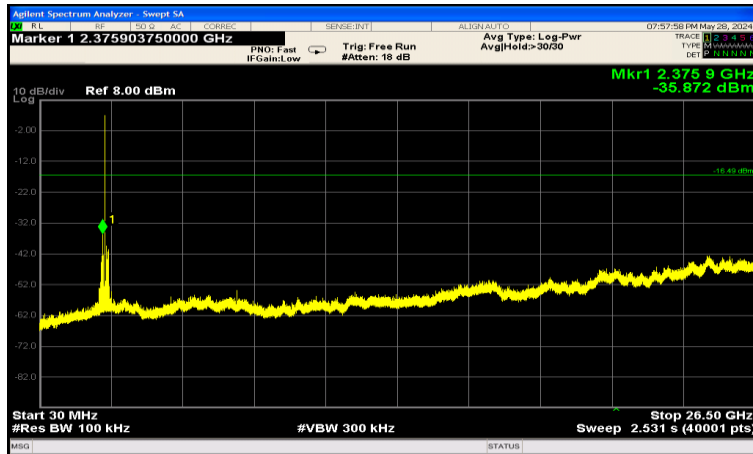

**Reference Level, Highest Channel (2 480 MHz)**

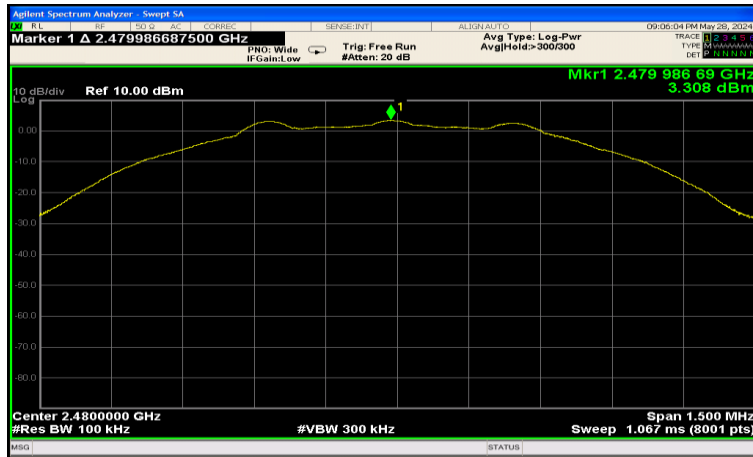

**Band Edge, Highest Channel (2 480 MHz)**



**Conducted Spurious Emissions, Highest Channel (2 480 MHz)**

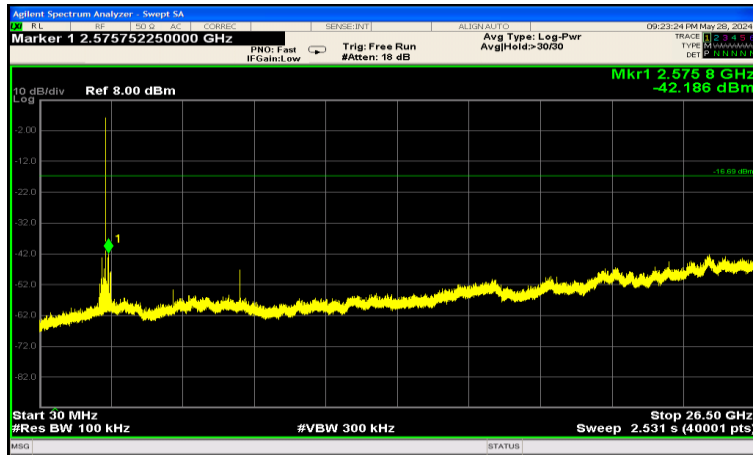

### 7.5 Radiated Spurious Emissions

FCC §15.205, §15.209, §15.247(d)  
RSS-Gen (8.9),(8.10)

Test Mode : Set to Lowest channel, Middle channel and Highest channel

#### Result

##### Lowest channel (2 402 MHz)

Frequency (MHz)	Reading (dBµV)	Pol* (H/V)	Mode*	AF+CL+Amp (dB)**	Result (dBµV/m)	Limit (dBµV/m)	Margin (dB)
4 804.50	51.07	V	PK	3.6	54.67	74.00	19.33
4 803.96	47.67	V	AV	3.6	51.27	54.00	2.73
7 640.67	38.41	V	PK	13.3	51.71	74.00	22.29
7 640.67	38.41	V	AV	13.3	51.71	54.00	2.29
11 164.13	37.81	H	PK	19.4	57.21	74.00	16.79
11 551.89	25.97	V	AV	19.9	45.87	54.00	8.13

##### Middle channel (2 440 MHz)

Frequency (MHz)	Reading (dBµV)	Pol* (H/V)	Mode*	AF+CL+Amp (dB)**	Result (dBµV/m)	Limit (dBµV/m)	Margin (dB)
4 879.50	50.70	V	PK	3.8	54.50	74.00	19.50
4 880.09	47.28	V	AV	3.8	51.08	54.00	2.92
7 319.33	42.52	V	PK	12.5	55.02	74.00	18.98
7 320.53	37.16	V	AV	12.5	49.66	54.00	4.34
10 847.78	37.48	H	PK	19.5	56.98	74.00	17.02
10 939.62	26.14	V	AV	19.5	45.64	54.00	8.36

##### Highest channel (2 480 MHz)

Frequency (MHz)	Reading (dBµV)	Pol* (H/V)	Mode*	AF+CL+Amp (dB)**	Result (dBµV/m)	Limit (dBµV/m)	Margin (dB)
4 959.67	49.71	H	PK	4.1	53.81	74.00	20.19
4 959.94	45.15	H	AV	4.1	49.25	54.00	4.75
7 440.67	44.05	H	PK	12.8	56.85	74.00	17.15
7 440.48	37.76	V	AV	12.8	50.56	54.00	3.44
11 815.83	38.10	V	PK	19.4	57.50	74.00	16.50
11 580.08	25.90	H	AV	19.8	45.70	54.00	8.30

**Notes:**

1. \*Pol. : H = Horizontal, V = Vertical, Mode : PK = Peak, AV = Average
2. \*\*AF + CL + Amp. = Antenna Factor + Cable Loss + Amplifier.
3. Average measurement was not performed when peak-detected emission complies with the average limit.
4. Other spurious was under 20 dB below Fundamental.
5. Lowest channel (2 402 MHz) was the worst condition.
6. The radiated emissions testing were made by rotating the receive antenna with horizontal, vertical polarization.
7. Peak emissions were measured using RBW = 1 MHz, VBW = 3 MHz, Detector = Peak.
8. Average emissions were measured using RBW = 1 MHz, VBW = 10 kHz, Detector = Peak.
9. The spectrum was measured from 1 GHz to 10th harmonic and the worst-case emissions were reported.

## PLOTS OF EMISSIONS

### Worst Case

**Lowest Channel (2 402 MHz) : 1 GHz to 8 GHz\_Peak**

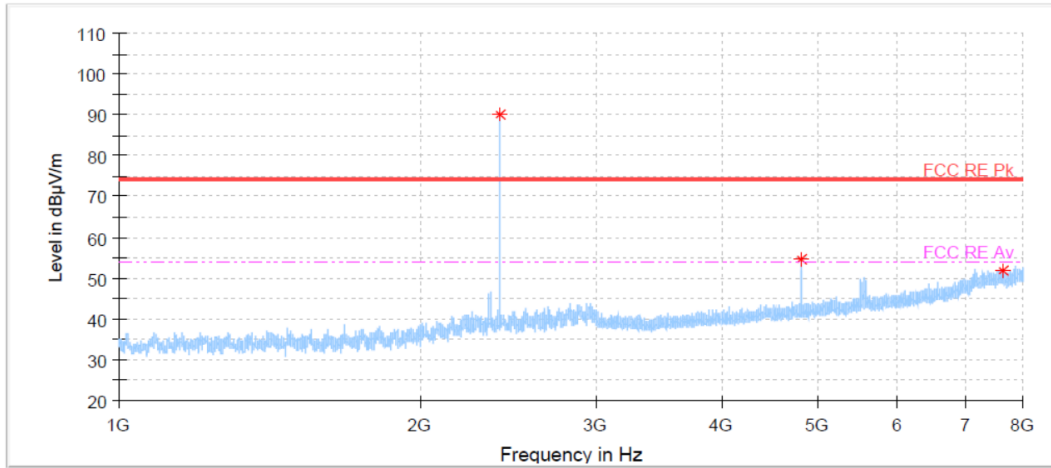

**Lowest Channel (2 402 MHz) : 2<sup>nd</sup> harmonic\_Average**

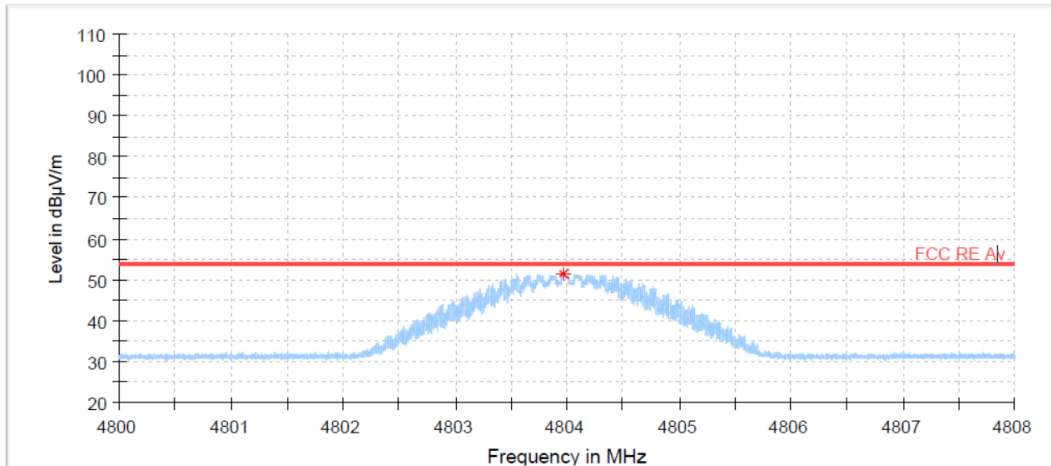

**Lowest Channel (2 402 MHz) : 8 GHz to 12.75 GHz\_Peak**

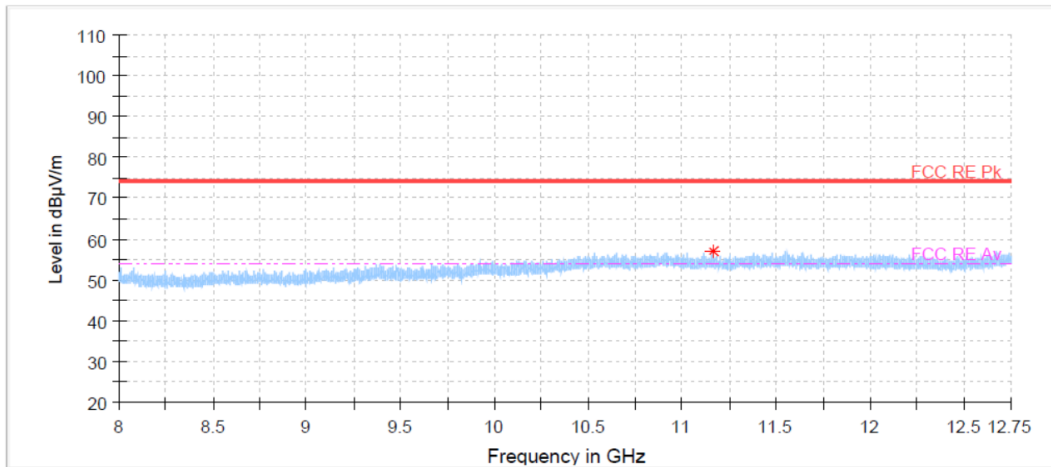

**Lowest Channel (2 402 MHz) : 8 GHz to 12.75 GHz\_Average**

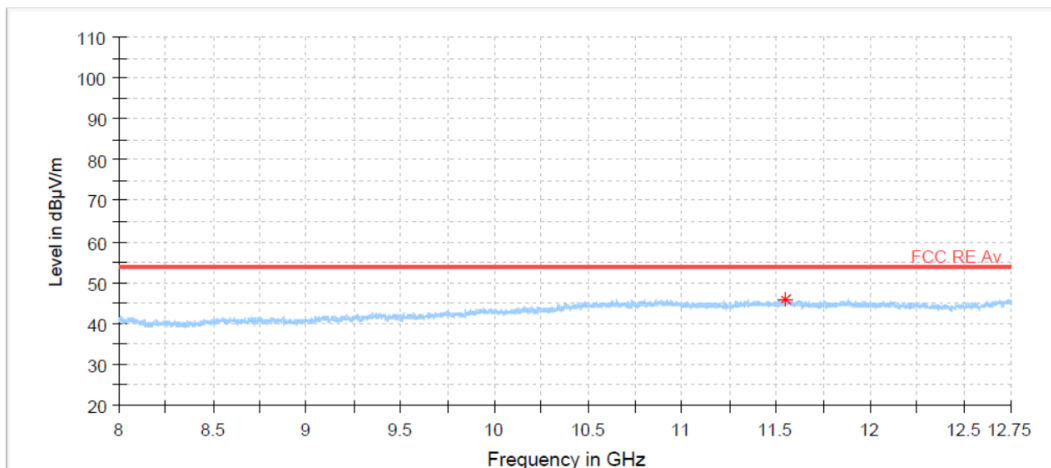

**Lowest Channel (2 402 MHz) : 12.75 GHz to 18 GHz\_Peak**

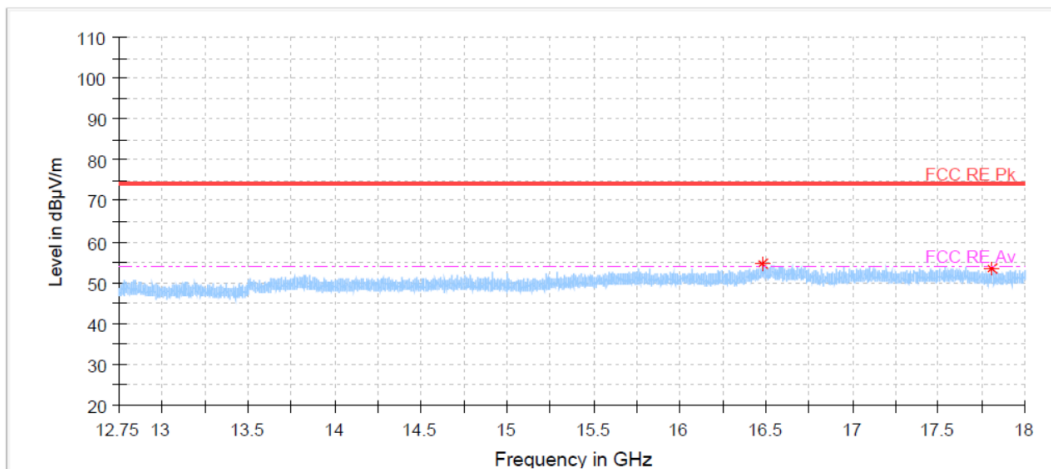



**Lowest Channel (2 402 MHz) : 12.75 GHz to 18 GHz\_Average**

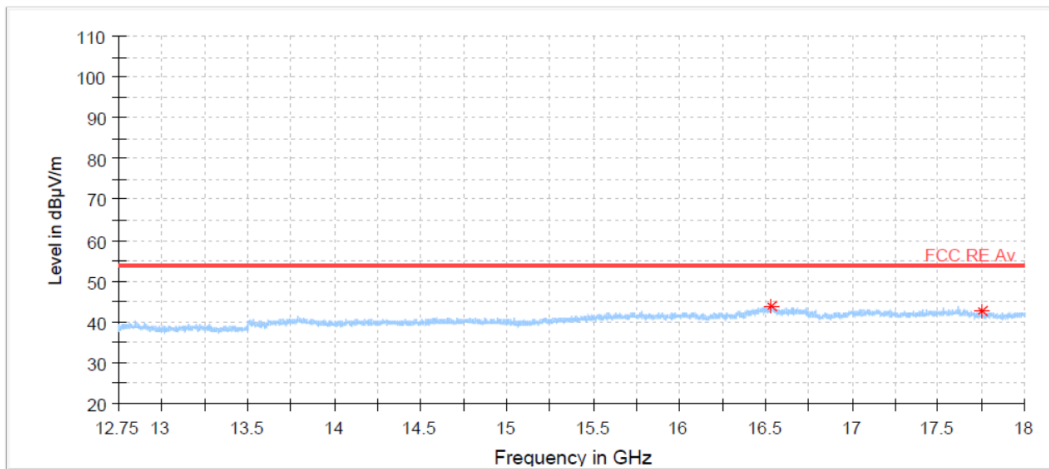

**Lowest Channel (2 402 MHz) : 18 GHz to 26.5 GHz\_Peak**

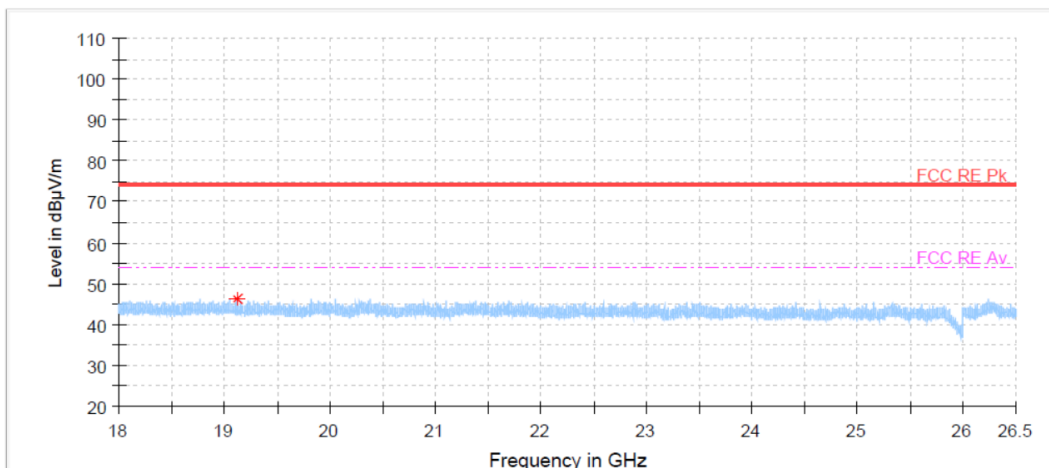

## 7.6 Radiated Band Edge

FCC §15.205, §15.209  
RSS-Gen (8.9),(8.10)

Test Mode : Set to Lowest channel and Highest channel

### Result

#### Lowest Channel (2 402 MHz)

Frequency (MHz)	Reading (dBµV)	Pol* (H/V)	Mode*	AF+CL+Amp (dB)**	Result (dBµV/m)	Limit (dBµV/m)	Margin (dB)
2 317.90	55.72	V	PK	-5.5	50.22	74.00	23.78
2 317.90	55.72	V	AV	-5.5	50.22	54.00	3.78
2 390.00	44.96	V	PK	-5.4	39.56	74.00	34.44
2 390.00	44.96	V	AV	-5.4	39.56	54.00	14.44

#### Highest Channel (2 480 MHz)

Frequency (MHz)	Reading (dBµV)	Pol* (H/V)	Mode*	AF+CL+Amp (dB)**	Result (dBµV/m)	Limit (dBµV/m)	Margin (dB)
2 483.50	43.01	V	PK	-5.3	37.71	74.00	36.29
2 483.50	43.01	V	AV	-5.3	37.71	54.00	16.29
2 498.89	45.74	V	PK	-5.5	40.24	74.00	33.76
2 498.89	45.74	V	AV	-5.5	40.24	54.00	13.76

### Notes:

- \*Pol. : H = Horizontal, V = Vertical, Mode : PK = Peak, AV = Average
- \*\*AF + CL + Amp. = Antenna Factor + Cable Loss + Amplifier.
- Average measurement was not performed when peak-detected emission complies with the average limit.
- Other spurious was under 20 dB below Fundamental.
- The radiated emissions testing were made by rotating the receive antenna with horizontal, vertical polarization.
- Peak emissions were measured using RBW = 1 MHz, VBW = 3 MHz, Detector = Peak.

## PLOTS OF EMISSIONS

**Lowest Channel (2 402 MHz)\_Peak**

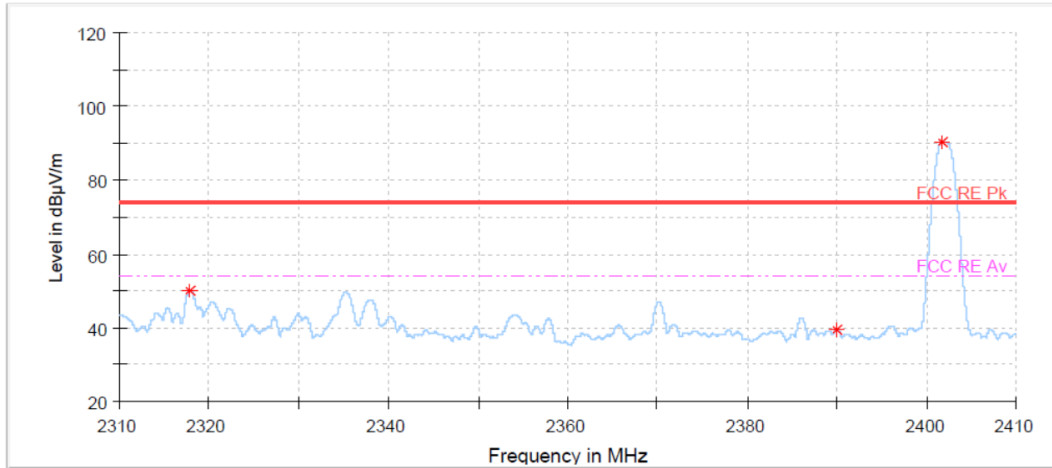

**Highest Channel (2 480 MHz)\_Peak**

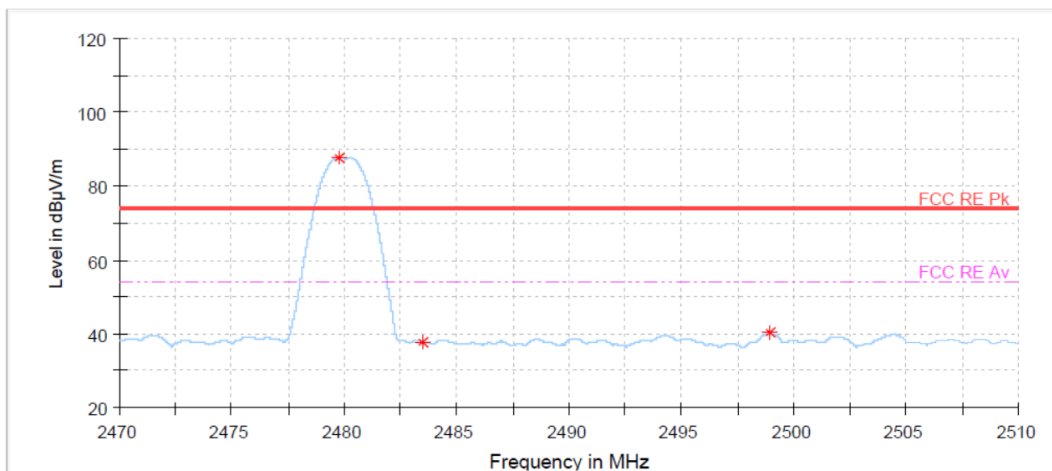

## 7.7 Radiated Emissions\_Below 1GHz

FCC §15.209  
RSS-Gen (8.9),(8.10)

### Result

#### Lowest Channel (2 402 MHz)

Frequency (MHz)	Reading (dBµV)	Pol* (H/V)	Mode*	AF+CL+Amp (dB)**	Result (dBµV/m)	Limit (dBµV/m)	Margin (dB)
54.80	35.62	V	QP	-6.48	29.14	40.00	10.86
89.07	30.67	H	QP	-10.18	20.49	43.50	23.01
137.51	41.99	H	QP	-11.55	30.44	43.50	13.06
236.77	37.08	H	QP	-6.79	30.29	46.00	15.71
323.91	38.92	H	QP	-5.60	33.32	46.00	12.68
349.03	36.46	H	QP	-4.48	31.98	46.00	14.02

#### Radiated Measurements at 3meters

#### Notes:

1. The worst-case emission was reported.
2. \*Pol. : H = Horizontal, V = Vertical, Mode : PK = Peak, QP = Quasi-Peak
3. \*\*AF + CL + Amp. = Antenna Factor + Cable Loss + Amplifier.
4. Measurements using CISPR quasi-peak mode below 1 GHz.
5. The radiated emissions testing were made by rotating the receive antenna with horizontal, vertical polarization. The worst data was recorded.
6. No emission found between lowest internal used/generated frequency to 30MHz (9kHz~30MHz).  
Per FCC part 15.31(o), test results were not reported.  
Although these tests were performed other than open field test site, adequate comparison measurements were confirmed against 30 m open are test site.  
Therefore, sufficient tests were made to demonstrate that the alternative site produces results that correlate with the one of tests made in an open field based on KDB 414788.
7. The limit is on the FCC §15.209.

## PLOTS OF EMISSIONS

### Worst Case

#### *Radiated emission below 1GHz, Lowest Channel (2 402 MHz)*

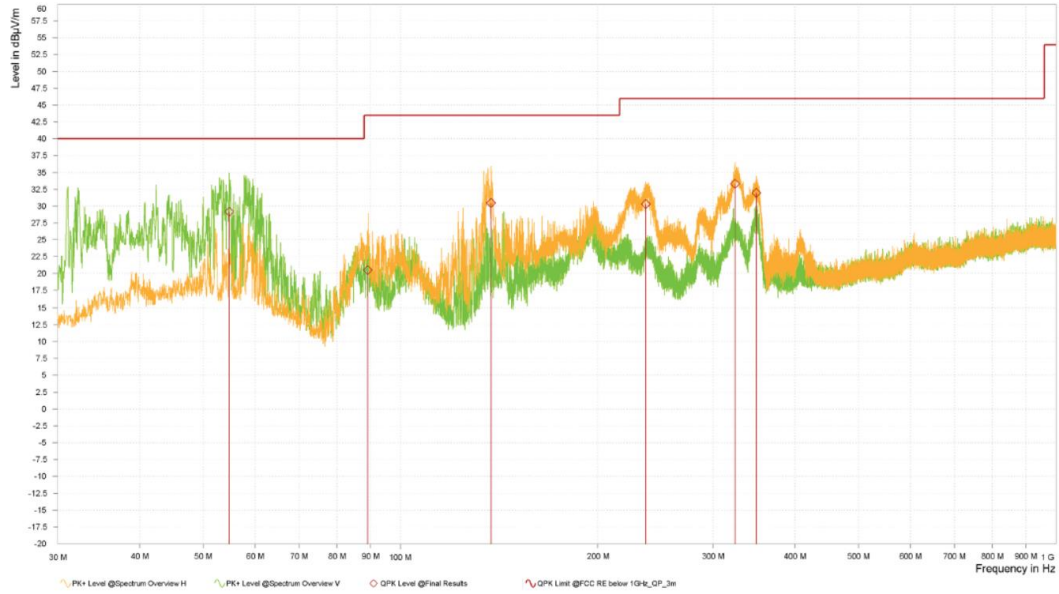

## 7.8 AC Line Conducted

FCC §15.207  
RSS-Gen(8.8)

**Result :**

Lowest Channel (2 402 MHz)

Frequency (MHz)	QuasiPeak (dBµV)	CAverage (dBµV)	Limit (dBµV)	Margin (dB)	Line	Corr. (dB)
0.261938	---	16.76	51.08	34.32	L1	9.6
0.261938	28.99	---	61.08	32.08	L1	9.6
0.264425	---	16.84	51.00	34.16	N	9.6
0.264425	31.07	---	61.00	29.94	N	9.6
0.396263	---	16.33	47.83	31.50	N	9.8
0.396263	31.29	---	57.83	26.53	N	9.8
0.460938	28.46	---	56.64	28.17	L1	9.9
0.460938	---	15.58	46.64	31.06	L1	9.9
0.525613	28.08	---	56.00	27.92	N	9.8
0.525613	---	14.04	46.00	31.96	N	9.8
7.871200	29.00	---	60.00	31.00	L1	9.8
7.871200	---	12.21	50.00	37.79	L1	9.8
8.990575	29.39	---	60.00	30.61	L1	9.8
8.990575	---	12.26	50.00	37.74	L1	9.8
8.993063	---	12.99	50.00	37.01	L1	9.8
8.993063	32.40	---	60.00	27.60	L1	9.8
9.326388	---	13.18	50.00	36.82	L1	9.8
9.326388	32.58	---	60.00	27.42	L1	9.8

Line Conducted Emissions Tabulated Data

**Notes:**

1. Measurements using CISPR quasi-peak mode & average mode.
2. The worst channel was investigated and the worst -case emission are reported. See attached Plots.
3. Lowest channel (2 402MHz) is the worst case.
4. \*) Factor = LISN + Cable Loss
5. \*\*) LINE : L = Line , N = Neutral
6. The limit is on the FCC §15.207(a) & RSS-Gen(8.8)

### PLOTS OF EMISSIONS

#### Worst Case

#### AC Line Conducted emission, Lowest Channel (2 402 MHz)

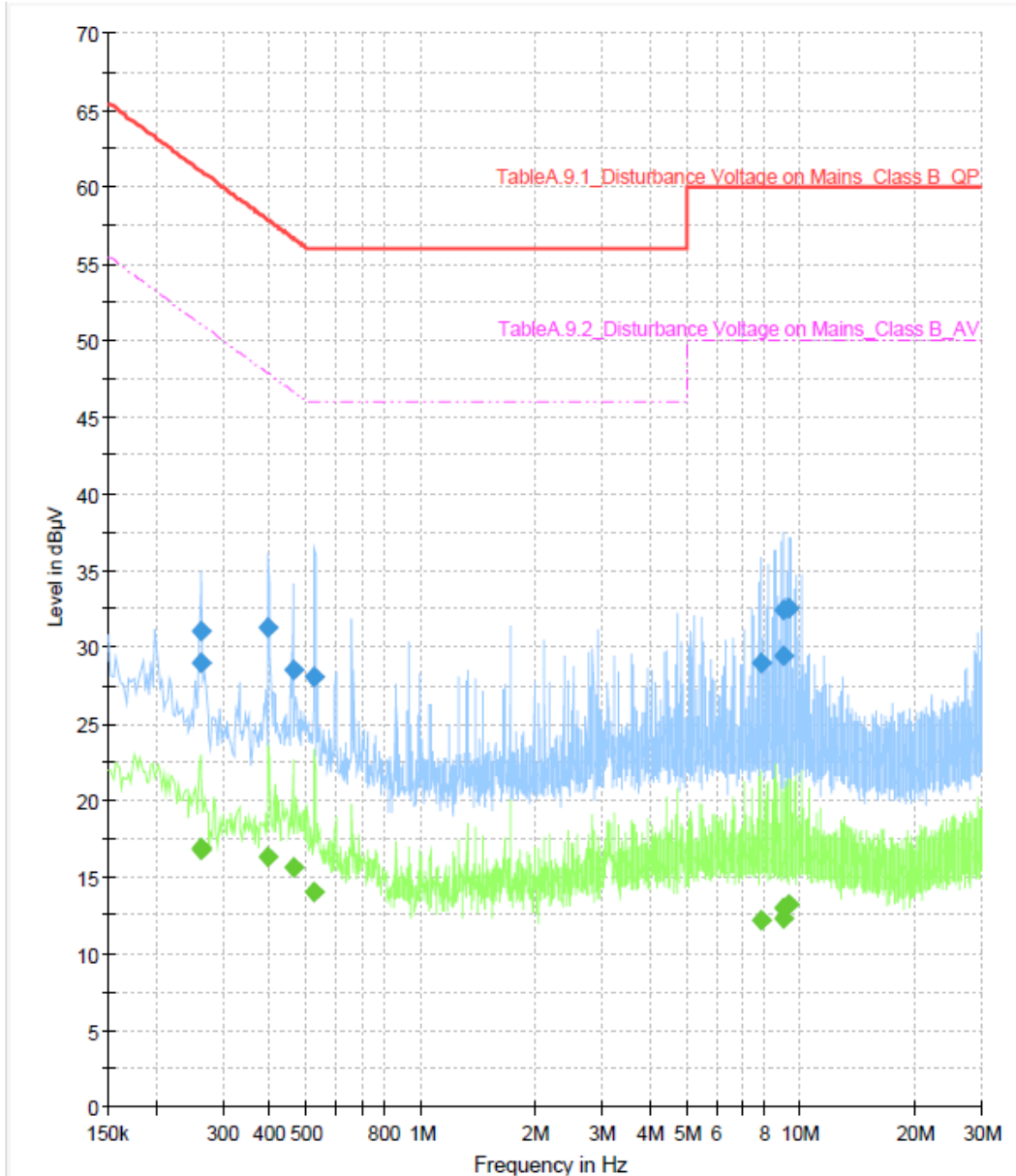

## **8. TEST EQUIPMENT**

No.	Instrument	Manufacture	Model	Serial No.	Calibration Date	Next Calibration Date
1	DIGITAL MULTIMETER	EZ DIGITAL	DM-334	2111395	10/11/23	10/11/24
2	Humidity Temperature	Lutron	MHB-382SD	AK.26553	10/18/23	10/18/24
3	Spectrum Analyzer	Agilent	N9020A	MY51110087	07/02/24	07/02/25
4	Programmable Power Supply	R&S	HMP2030	101325	10/10/23	10/10/24
5	10 dB Attenuator	API technologies corp	40A2W-10	1916	07/03/24	07/03/25
6	Signal Generator	R&S	SMB100A	175861	03/29/24	03/29/25
7	Double Ridged Broadband Horn Antenna	Schwarzbeck	BBHA 9120 D	9120D-508	07/09/24	07/09/25
8	Horn Antenna	Q-par Angus	QMS-00208	17636	08/28/24	08/28/25
9	Signal Conditioning Unit	R&S	SCU-18F	180025	03/27/24	3/27/25
10	Horn Antenna	Q-par Angus	QSH20S20	8179	07/09/24	07/09/25
11	Signal Conditioning Unit	R&S	SCU-26	10011	07/05/24	07/05/25
12	OPEN SWITCH AND CONTROL UNIT	R&S	OSP120	100081	N/A	N/A
13	WiFi Filter Bank	R&S	U083	N/A	N/A	N/A
14	Signal & Spectrum Analyzer	R&S	FSW43	104084	03/27/24	03/27/25
15	TRILOG Broadband Test Antenna	Schwarzbeck	VULB 9163	01431	11/16/22	11/16/24
16	EMI TEST RECEIVER	R & S	ESW44	103318	01/08/24	01/08/25
17	AMPLIFIER	HP	8447F	2805A03406	01/09/24	01/09/25
18	Open Switch and Control Unit	R&S	OSP220	102977	N/A	N/A
19	HYGROMETER	N/A	OREGON	0726-1	07/08/24	07/08/25
20	EMI TEST RECEIVER	R&S	ESR3	102930	07/02/24	07/02/25
21	TWO-LINE V-NETWORK	R&S	ENV216	102829	07/03/24	07/03/25



## **9. ACCURACY OF MEASUREMENT & DECISION RULE**

### **9.1 Uncertainty Calculation**

The Measurement Uncertainties stated were calculated in accordance with the requirements of measurement uncertainty contained in CISPR 16-4-2 with the confidence level of 95%

<b>PARAMETER</b>	<b>UNCERTAINTY</b>
Radiated Disturbance, Below 30 MHz	4.5 dB
Radiated Disturbance, 30 MHz to 1 GHz	3.4 dB
Radiated Disturbance, Above 1 GHz	4.9 dB

### **9.2 Decision rule**

The choice of whether or not to include the measurement uncertainty of the measuring system used in the test in the conformance determination.:

- Application of internal procedures used in type testing where traceability of measurement uncertainty is established.
- Applying the decision that the standard used for type testing does not require it.

**END REPORT**