

VERTU

VRing

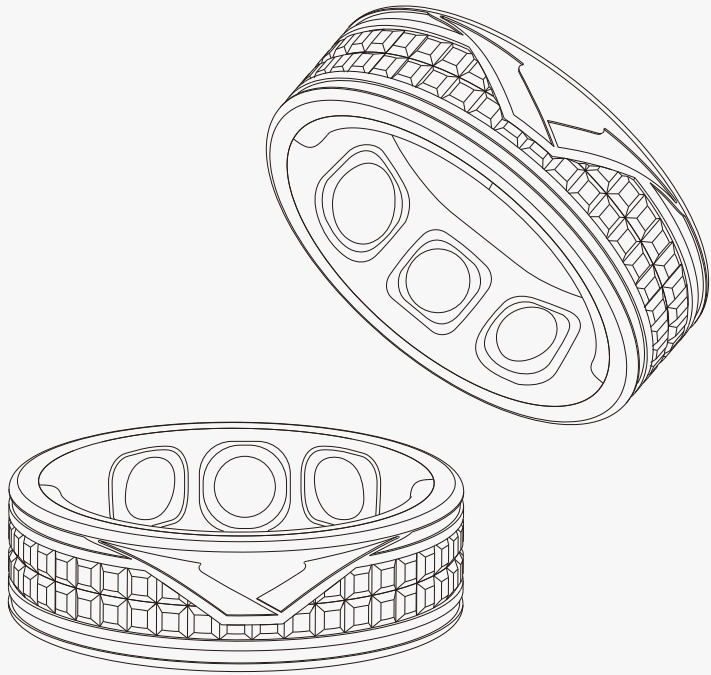

Click to turn the page



Product Description

Product Description

This product is a smart health ring that can monitor a variety of health signs of the human body around the clock.

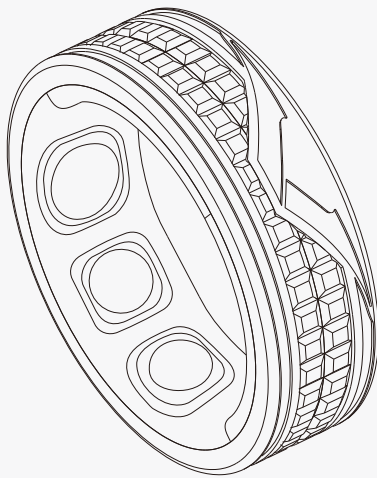

Heart rate



Blood oxygen



Sleep
monitoring



Non-invasive
blood sugar



Stress



Activity
tracking



VO2 max



Women's health
management



Body
temperature
trend



Heart
rate variability

Click to turn the page



Product Description

product parameters

Product name: VRing

ring Product model: VR11001-13

Battery Type: Rechargeable Polymer Hammer Battery

Battery capacity: 14. SmAh - 21. SmAh (depending on the size of the ring)

Charging time: <2 hours

Duration: 7~10 days

Rated input of charging box: 5V—1A

Bluetooth version: BLE5.0

Device requirements: only supporting paired Android 5.0 or iOS 10.0 and above device

Data storage: 15day

Product executive standard: GB4943.1-2022 《Audio-visual, information and communications technology equipment-part 1: Safety requirements》

Maximum exercise time: 99 hours and 59 minutes

calorie consumption: 999.9 kcal

kcalMaximum exercise distance: 999.99KM

Operating temperature range: -10-50 °C

CMIIT ID: 2023DP15910

Click to turn the page



The list of products

- (1) The smart ring
- (2) wireless charging case
- (3) Type-C charging cable

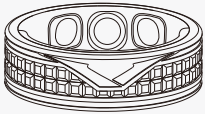

(1)

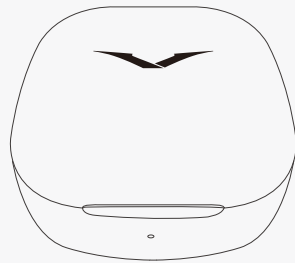

(2)

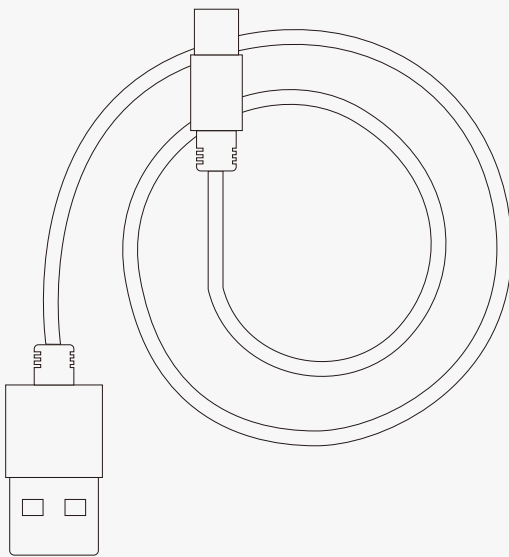

(3)

Click to turn the page



Guidelines for use

1、Download APP

Scan the QR code below to download the application

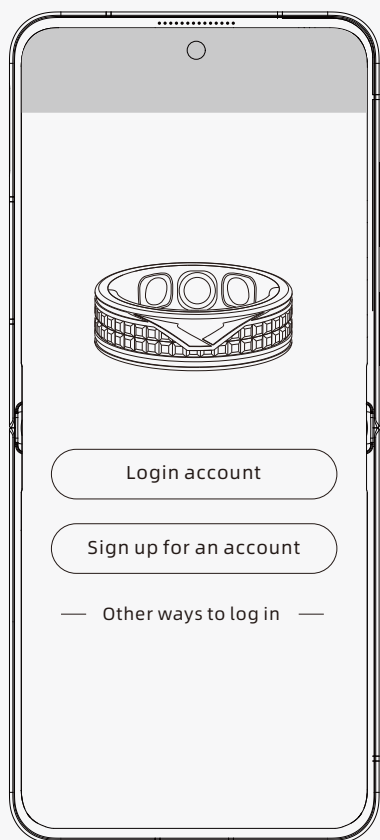

Tips: Please make sure your mobile phone is Android 5.0 or above; IOS system version is 10.0 and above. This ring supports Bluetooth 5.0 links.

Click to turn the page



2. Charging the activation device

- Please use the charging case to charge the smart ring for the first time Charge activation.
- If the factory settings are restored on the APP, please charge the device again to activate it.

3. Bluetooth pairing

1. Open the APP on the mobile phone to register or log in to your account;
2. Click "+" on the APP home page to add a device and select the device to be connected.

Note: During the pairing and connection process, please make sure that the Bluetooth and positioning function of your cell phone is turned on and the distance between your cell phone and the ring is within the effective connection range.

charging instructions

1. Plug the wireless charging box into the Type-C charging cable, and then plug the other end of the TypeC charging cable into the 5V/1A USB power supply. When the power supply is connected, the blue indicator light on the charging box will stay on;

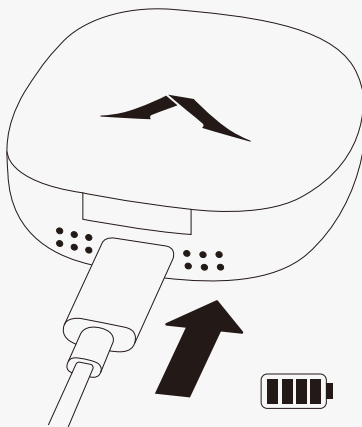

2. Put the smart ring into the wireless charging box, the green light on the ring blinks slowly when charging, indicating that it is charging

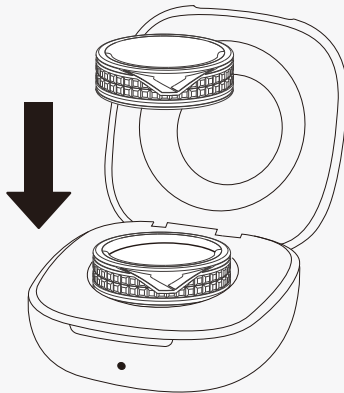

Click to turn the page



Wearing a ring

1. Please wear the ring on the appropriate finger and choose a size that is comfortable for you Not too loose, not too tight.

2. When wearing the ring, make sure that the ring sensor is facing the palm side of the finger, to obtain better measurement results.

Note: Wearing the device too loosely will affect heart rate and blood oxygen data collection.

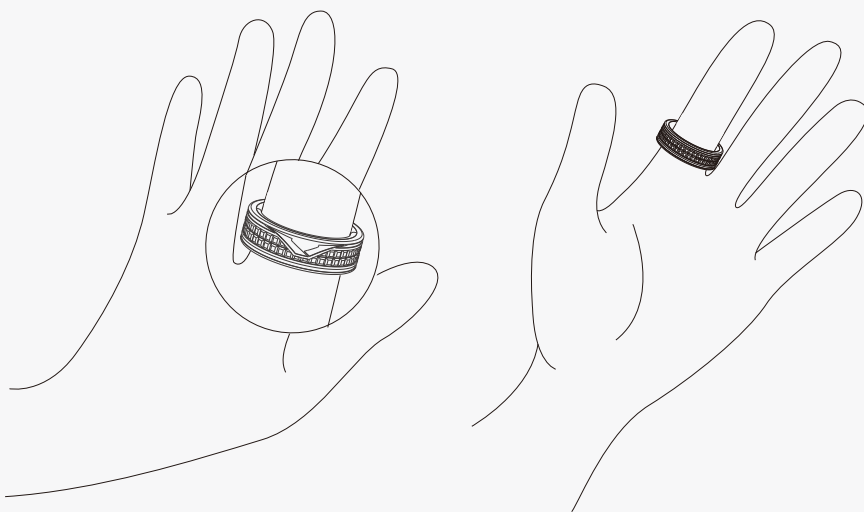
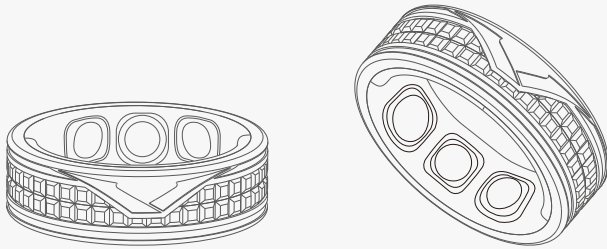

Click to turn the page



APP function introduction

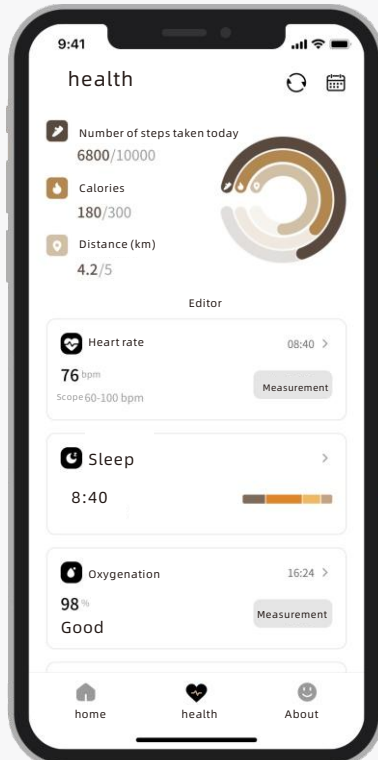
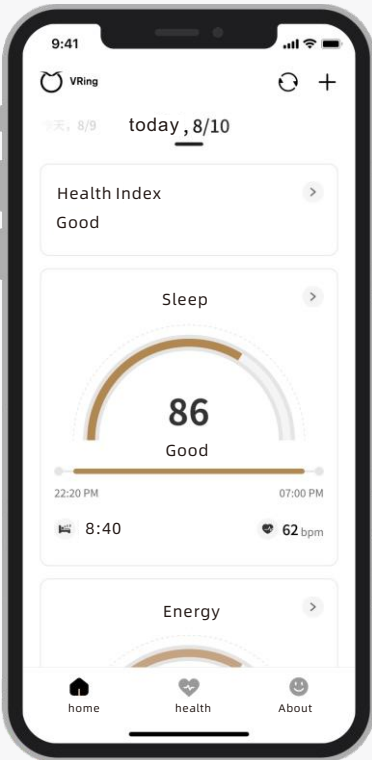

Heart rate

- 24-hour automatic measurement (adjustable automatic interval)
- daily / weekly / monthly heart rate reports
- APP initiates manual measurement at any time

Oximetry

- 24-hour automatic measurement (adjustable automatic interval)
- daily/weekly/monthly oximetry reports
- APP initiates manual measurement at any time

Click to turn the page



Sleep

Automatic sleep monitoring, recording sleep data including sporadic naps, wakefulness, REM sleep and deep sleep

- Sleep Profile, Calculate Sleep Duration, Sleep Efficiency, Time to Sleep, Sleep Quality Daily / Weekly / Monthly Sleep Report

noninvasive glucose

trend assessment

- Based on AI artificial intelligence algorithm, combined with the builtin high-performance sensor of the ring, continuously collect and monitor the physical sign data under different states of the body, and comprehensively assess and predict your blood sugar risk
- Daily/weekly/monthly activity report APP initiates manual measurement of

Heart rate variability

- 24-hour automatic measurement (adjustable automatic interval)
- Daily / Weekly / Monthly Heart Rate Variability Report

Click to turn the page



Activities

- All-day step, distance, and calorie tracking
- daily / weekly / monthly activity reports
- Personalized goal setting to track your daily achievements
- (a) Maximum oxygen uptake measurements during exercise to assess progress in exercise capacity and endurance
- daily / weekly / monthly activity reports
- APP initiates manual measurement at any time

Stress

24-hour automatic measurement (adjustable automatic interval)

- daily/weekly/monthly stress reports

changes in body temperature

24-hour automatic measurement

- Daily / Weekly / Monthly Temperature Trend Report

Troubleshooting

If the ring cannot be paired with the cell phone

1. Make sure the ring is on.
2. Check your cell phone to make sure Bluetooth is turned on.
3. Check whether the Bluetooth permission of the APP is on , which can be queried in the Bluetooth settings of the mobile phone.
4. Make sure that the distance between the cell phone and the ring is within the range of a valid connection.

Click to turn the page



safety and precautions

Before using and operating the equipment, please read and observe the following precautions to ensure that the ring contact area is kept dry for optimum performance and to avoid hazardous or illegal conditions.

- 24-hour automatic measurement (adjustable automatic interval)

Initial use

Please choose a ring size that fits your finger to avoid wearing it too tightly; If you have not worn similar products before, it may take some time to get used to them. If symptoms such as redness and swelling appear on the wearing area, discontinue use immediately and consult a physician.

Daily use

- When wearing the ring, make sure that the ring sensor is facing the palm side of the finger for better measurement results.
- When choosing to measure heart rate or blood oxygen manually, please try to stay as still as possible to obtain more accurate measurement data.
- If the ring gets stuck when you try to remove it, try wetting your finger with cold water and mild soap and slowly turning the ring to remove it.

radio safety warnings

In medical or other places where the use of wireless devices is prohibited, observe the rules of the place and turn off the device.

- The radio waves generated by the device may affect the normal operation of implanted medical devices or personal medical equipment, such as pacemakers, cochlear implants hearing aids, etc. If you are using such medical equipment, please consult with the manufacturer of such equipment for restrictions on the use of this device.

Click to turn the page



child safety warnings

This product and its accessories may contain some small parts, please keep this equipment and accessories out of the reach of children, to prevent children from swallowing small parts, otherwise it may cause injury. This product is not a toy and should be used by children under adult supervision.

battery safety warning

This device is equipped with a non-removable internal battery, please do not replace the battery yourself to avoid damage to the battery or the device.

- Do not disassemble or modify the battery, insert foreign objects, or immerse it in water or other liquids, as this may cause the battery to leak, overheat, catch fire or explode.
- Do not drop, crush or puncture the battery. Avoid subjecting the battery to large external pressures that could cause internal short circuits and overheating.
- Do not dispose of this unit and its accessories as ordinary household waste.
- Please comply with local laws and regulations regarding the disposal of this equipment and its accessories, and support recycling initiatives

charging safety warning

Please keep the charging case and the device in a dry environment when charging, do not touch the charging case with wet hands, otherwise it may cause a short circuit.

- When charging, do not touch the power supply with wet hands as this may cause injury.

accessory requirements

- Please use the charging case supplied with this device to charge your ring.
- The charging case supplied with this unit may not be used for charging other products.
- Please use a power adapter that meets CCC certification.

Click to turn the page



cleaning and maintenance

- Wipe the unit or its accessories with a clean, dry, soft cloth.
- Do not use external heating devices such as microwave ovens or hair dryers to dry them.
- Do not use harsh chemicals, detergents or other corrosive chemicals to clean the equipment or its accessories as this may cause damage to the product.
- Before cleaning and servicing the unit, stop using the unit ,turn off all applications and disconnect all connections or cables to other equipment.

Operating and storage environmental requirements

- Use the device within the temperature range of 0 °C to 35 °C and at temperatures of -5 °C to 50 °C. The device may malfunction when the ambient temperature is too high or too low. When the ambient temperature is too high or too low, it may cause the device to malfunction. When the temperature is lower than 5°C, the performance of the battery will be limited.
- Do not place the unit in direct sunlight, such as the dashboard of a car or on a window sill.
- Do not place the appliance near sources of heat or naked flames, such as electric heaters, microwave ovens, hot water heaters, stoves, candles, or other places where high temperatures may be generated.
- Do not use the equipment near magnetic fields, as this may cause the equipment circuit to malfunction.
- Do not use this equipment during thunderstorms, as this may cause equipment malfunction or risk of electric shock.
- Do not leave your magnetic stripe card (e.g. bank card, phone card, etc.) in contact with the device for a long period of time, as this may cause the magnetic stripe card to become invalid.

Electronic information products toxic and harmful substances declaration

Part name	An element of a poisonous or noxious substance					
	Pb	(Hg)	(Cd)	(Cr6+)	(PBB)	(PBDE)
The shell	○	○	○	○	○	○
Inner Shell	○	○	○	○	○	○
Circuit board	○	○	○	○	○	○
Batteries	×	○	○	○	○	○

○: Indicates that the content of the toxic and harmful substance in all homogeneous materials of the component is below the limit requirements stipulated in GB/T26572 - 2011 "Limits of substances for use in electronic and electrical products, quantity requirements"

×: It is indicated that the content of the toxic and harmful substance exceeds the limit requirement of GB/T26572 - 2011 "Limit substances and material limit requirements for electronic and electrical products" in at least one homogeneous material of the component.

 The symbol is the electronic information product pollution control sign, indicated this product, the environmental protection use time limit is 10 years, and may recycle, should not casually discard.

 Recyclable icon.

Click to turn the page



after-sales policy

After-sales service is strictly based on the "Law of the People's Republic of China on the Protection of Consumer Rights and Interests", "Law of the People's Republic of China on Product Quality" and industry regulations. Within the validity period of the three packages, you can enjoy free return, exchange and repair services in accordance with these provisions. When returning or exchanging the goods, you need to present the invoice or proof of purchase, and the warranty card.

quality warranty card

Model	
Instrument number	
Purchase date	
Purchase channels	
Name	
Contact number	
Address	
Brief description of after-sales problems	

Click to turn the page



Certificate of Compliance

Product Name	
Product Model Number	
product implementation standards	GB4943.1-2022
product lot /number	
Date of manufacture	
inspectors	
Date of inspection	
test results	
production units	
Manufacturing address	

Click to turn the page



FCC Requirement

Any changes or modifications not expressly approved by the party responsible for compliance could void the user's authority to operate the equipment. This device complies with Part 15 of the FCC Rules. Operation is subject to the following two conditions:

(1) this device may not cause harmful interference, and
(2) this device must accept any interference received, including interference that may cause undesired operation.

. Note: This equipment has been tested and found to comply with the limits for a Class B digital device, pursuant to Part 15 of the FCC Rules. These limits are designed to provide reasonable protection against harmful interference in a residential installation. This equipment generates, uses, and can radiate radio frequency energy, and if not installed and used in accordance with the instructions, may cause harmful interference to radio communications. However, there is no guarantee that interference will not occur in a particular installation. If this equipment does cause harmful interference to radio or television reception, which can be determined by turning the equipment off and on, the user is encouraged to try to correct the interference by one or more of the following measures:

- Reorient or relocate the receiving antenna.
- Increase the separation between the equipment and receiver.
- Connect the equipment into an outlet on a circuit different from that to which the receiver is connected.
- Consult the dealer or an experienced radio/TV technician for help.

Click to turn the page

