



<b>FCC TEST REPORT</b>	
<b>FCC ID:2BGCX-A6S8A5X10</b>	
<b>Report Number</b> .....	<b>ZKT-241030L14228E-1</b>
Date of Test.....	Aug. 28, 2024 to Nov. 12, 2024
Date of issue.....	Nov. 12, 2024
Test Result.....	PASS
<b>Testing Laboratory</b> .....	<b>Shenzhen ZKT Technology Co., Ltd.</b>
Address .....	1/F, No. 101, Building B, No. 6, Tangwei Community Industrial Avenue, Fuhai Street, Bao'an District, Shenzhen, China
<b>Applicant's name</b> .....	<b>Shenzhen Yufengzhixing Electronics Tech Co Ltd</b>
Address .....	RM301-01, Yuan Shuo Tech Park, No8 Nanxiang, Xinshiqiao St, Guanlan, Longhua, Shenzhen
<b>Manufacturer's name</b> .....	<b>Shenzhen Yufengzhixing Electronics Tech Co Ltd</b>
Address .....	RM301-01, Yuan Shuo Tech Park, No8 Nanxiang, Xinshiqiao St, Guanlan, Longhua, Shenzhen
<b>Test specification:</b>	
Standard.....	FCC CFR Title 47 Part 15 Subpart C Section 15.247
Test procedure.....	KDB558074 D01 15.247 Meas Guidance v05r02 ANSI C63.10:2013
Non-standard test method .....	N/A
<p>This device described above has been tested by ZKT, and the test results show that the equipment under test (EUT) is in compliance with the FCC requirements. And it is applicable only to the tested sample identified in the report.</p> <p>This report shall not be reproduced except in full, without the written approval of ZKT, this document may be altered or revised by ZKT, personal only, and shall be noted in the revision of the document.</p>	
<b>Product name</b> .....	<b>Car Navigation Multimedia</b>
Trademark .....	/
Model/Type reference.....	A6G2B7PF, A6G2B7PF, S8BM3S5L12B8PN-N, S8BM3S412B8PN-N, S8BM5S512B8PN-N, S8BM5S412B8PN-N, S8BMX1612B8PN-N, S8BMX1512B8PN-N, S8BMX5512B8PN-N, S8BMX54L12B8PN-N, S8BMX53L12B8PN-N, S8MBGA512C8PN-N, S8MBGA412C8PN-N, S8MBBC312C8PN-N, S8MBBC412C8PN-N, S8MBBC512C8PN-N, S8MBGC512C8PN-N, S8MBCC4L12C8PN-N, S8MBCC312C8PN-N, S8MBEC6L12C8PN-N, S8MBEC5L12C8PN-N, S8MBEC4L12C8PN-N, S8ADA44XL12A8PN-N, S8ADA44YL12A8PN-N, S8ADQ54XL12A8PN-N, S8ADQ54YL12A8PN-N, A5LG2B7T, A5LG209T, A5LG211T, S8G212A8PN, S8G212B8PN, S8G212C8PN, X10G2A7E-R2, X10G210E-N, X10G2D7E-N, X10G215E-N, X10G229E-N, X10G257E-N, X10G2D7E-N-R1, X10G2D7E-R2, X10G2D7E-N-R3, X10G2B7E-N-R1, X10G2B7E-N-R2, X10G2B7E-N-R3, AD3BPL-BK, AD3BPL-GY, AC-CG2M1C, AC-CG2M2B, AC-CG2M3CB, AC-CG2M4CB



Model Difference .....: A6G2B7PF is tested model, other models are derivative models .The models are identical in circuit, only different on the model names. So the test data of A6G2B7PF can represent the remaining models.

Ratings.....: Input: DC 12V/15A

**Testing procedure and testing location:**

**Testing Laboratory.....: Shenzhen ZKT Technology Co., Ltd.**

Address.....: 1/F, No. 101, Building B, No. 6, Tangwei Community Industrial Avenue, Fuhai Street, Bao'an District, Shenzhen, China

Tested by (name + signature).....: Alen He

Reviewer (name + signature).....: Joe Liu

Approved (name + signature).....: Lake Xie





## Table of Contents

	Page
<b>1. VERSION</b> .....	<b>5</b>
<b>2. SUMMARY OF TEST RESULTS</b> .....	<b>6</b>
<b>2.1 TEST FACILITY</b> .....	<b>7</b>
<b>2.2 MEASUREMENT UNCERTAINTY</b> .....	<b>7</b>
<b>3. GENERAL INFORMATION</b> .....	<b>8</b>
<b>3.1 GENERAL DESCRIPTION OF EUT</b> .....	<b>8</b>
<b>3.2 DESCRIPTION OF TEST MODES</b> .....	<b>9</b>
<b>3.3 BLOCK DIGRAM SHOWING THE CONFIGURATION OF SYSTEM TESTED</b> .....	<b>9</b>
<b>3.4 DESCRIPTION OF SUPPORT UNITS(CONDUCTED MODE)</b> .....	<b>10</b>
<b>3.5EQUIPMENTS LIST FOR ALL TEST ITEMS</b> .....	<b>11</b>
<b>4. EMC EMISSION TEST</b> .....	<b>13</b>
<b>4.1 CONDUCTED EMISSION MEASUREMENT</b> .....	<b>13</b>
<b>4.1.1 POWER LINE CONDUCTED EMISSION Limits</b> .....	<b>13</b>
<b>4.1.2 TEST PROCEDURE</b> .....	<b>13</b>
<b>4.1.3 DEVIATION FROM TEST STANDARD</b> .....	<b>13</b>
<b>4.1.4 TEST SETUP</b> .....	<b>14</b>
<b>4.1.5 EUT OPERATING CONDITIONS</b> .....	<b>14</b>
<b>4.1.6 TEST RESULT</b> .....	<b>14</b>
<b>4.2 RADIATED EMISSION MEASUREMENT</b> .....	<b>15</b>
<b>4.2.1 RADIATED EMISSION LIMITS</b> .....	<b>15</b>
<b>4.2.2 TEST PROCEDURE</b> .....	<b>15</b>
<b>4.2.3 DEVIATION FROM TEST STANDARD</b> .....	<b>16</b>
<b>4.2.4 TEST SETUP</b> .....	<b>16</b>
<b>4.2.5 EUT OPERATING CONDITIONS</b> .....	<b>17</b>
<b>4.2.6 TEST RESULTS</b> .....	<b>17</b>
<b>5. RADIATED BAND EMISSIONMEASUREMENT</b> .....	<b>22</b>
<b>5.1 TEST REQUIREMENT:</b> .....	<b>22</b>
<b>5.2 TEST PROCEDURE</b> .....	<b>22</b>
<b>5.3 DEVIATION FROM TEST STANDARD</b> .....	<b>22</b>
<b>5.4 TEST SETUP</b> .....	<b>23</b>
<b>5.5 EUT OPERATING CONDITIONS</b> .....	<b>23</b>
<b>5.6 TEST RESULT</b> .....	<b>24</b>
<b>6. POWER SPECTRAL DENSITY TEST</b> .....	<b>26</b>
<b>6.1 APPLIED PROCEDURES / LIMIT</b> .....	<b>26</b>
<b>6.2 TEST PROCEDURE</b> .....	<b>26</b>
<b>6.3 DEVIATION FROM STANDARD</b> .....	<b>26</b>
<b>6.4 TEST SETUP</b> .....	<b>26</b>
<b>6.5 EUT OPERATION CONDITIONS</b> .....	<b>26</b>



- 6.6 TEST RESULT .....27
- 7. CHANNEL BANDWIDTH ..... 28
  - 7.1 APPLIED PROCEDURES / LIMIT ..... 28
  - 7.2 TEST PROCEDURE ..... 28
  - 7.3 DEVIATION FROM STANDARD ..... 28
  - 7.4 TEST SETUP .....28
  - 7.5 EUT OPERATION CONDITIONS ..... 28
  - 7.6 TEST RESULT .....29
- 8. OUTPUT POWER TEST ..... 30
  - 8.1 APPLIED PROCEDURES/LIMIT ..... 30
  - 8.2 TEST PROCEDURE ..... 30
  - 8.3 DEVIATION FROM STANDARD ..... 30
  - 8.4 TEST SETUP .....30
  - 8.5 EUT OPERATION CONDITIONS ..... 30
  - 8.6 TEST RESULT .....30
- 9. CONDUCTED BAND EDGE AND SPURIOUS EMISSION ..... 31
  - 9.1 APPLICABLE STANDARD .....31
  - 9.2 TEST PROCEDURE ..... 31
  - 9.3 DEVIATION FROM STANDARD ..... 31
  - 9.4 TEST SETUP .....31
  - 9.5 EUT OPERATION CONDITIONS ..... 31
  - 9.6 TEST RESULTS ..... 31
- 10. ANTENNA REQUIREMENT ..... 32
- 11. APPENDIX WIFI .....33
  - 11.1 DUTY CYCLE ..... 33
  - 11.2 MAXIMUM CONDUCTED OUTPUT POWER .....40
  - 11.3 -6DB BANDWIDTH ..... 41
  - 11.4 OCCUPIED CHANNEL BANDWIDTH .....48
  - 11.5 MAXIMUM POWER SPECTRAL DENSITY LEVEL ..... 55
  - 11.6 BAND EDGE ..... 62
  - 11.7 CONDUCTED RF SPURIOUS EMISSION ..... 71
- 12. TEST SETUP PHOTO ..... 84
- 13. EUT CONSTRUCTIONAL DETAILS .....84



**1. VERSION**

Report No.	Version	Description	Approved
ZKT-241030L14228E-1	Rev.01	Initial issue of report	Nov. 12, 2024



## 2. SUMMARY OF TEST RESULTS

Test procedures according to the technical standards:

FCC Part15 (15.247) , Subpart C			
Standard Section	Test Item	Result	Remark
FCC part 15.203/15.247 (b)(4)	Antenna requirement	PASS	
FCC part 15.207	AC Power Line Conducted Emission	N/A	
FCC part 15.247 (b)(3)	Conducted Average Output Power	PASS	
FCC part 15.247 (a)(2)	Channel Bandwidth	PASS	
FCC part 15.247 (e)	Power Spectral Density	PASS	
FCC part 15.247(d)	Band Edge	PASS	
FCC part 15.205/15.209	Spurious Emission	PASS	

**NOTE:**

(1) " N/A" denotes test is not applicable in this Test Report



## 2.1 TEST FACILITY

Shenzhen ZKT Technology Co., Ltd.  
Add. : 1/F, No. 101, Building B, No. 6, Tangwei Community Industrial Avenue, Fuhai Street, Bao'an District, Shenzhen, China

FCC Test Firm Registration Number: 692225  
Designation Number: CN1299  
IC Registered No.: 27033

## 2.2 MEASUREMENT UNCERTAINTY

The reported uncertainty of measurement  $y \pm U$  · where expended uncertainty U is based on a standard uncertainty multiplied by a coverage factor of  $k=2$  · providing a level of confidence of approximately 95 % .

No.	Item	Uncertainty
1	3m chamber Radiated spurious emission(9KHz-30MHz)	U=4.5dB
2	3m chamber Radiated spurious emission(30MHz-1GHz)	U=4.3dB
3	3m chamber Radiated spurious emission(1GHz-18GHz)	U=4.5dB
4	3m chamber Radiated spurious emission(18GHz-40GHz)	U=3.34dB
5	Conducted Adjacent channel power	U=1.38dB
6	Conducted output power uncertainty Above 1G	U=1.576dB
7	Conducted output power uncertainty below 1G	U=1.28dB
8	humidity uncertainty	U=5.3%
9	Temperature uncertainty	U=0.59°C
10	Radiated disturbance(30MHz-1000MHz)	U=4.8dB
11	Radiated disturbance(1GHz-6GHz)	U=4.9dB
12	Radiated disturbance(1GHz-18GHz)	U=5.0dB
13	Occupied Bandwidth	U=±4.96%
14	Conducted spurious emissions	±0.21dB
15	Power Spectral Density	U=0.77dB



### 3. GENERAL INFORMATION

#### 3.1 GENERAL DESCRIPTION OF EUT

Product Name:	Car Navigation Multimedia
Test Model No.:	A6G2B7PF
Hardware Version:	V1.0
Software Version:	V1.0
Sample(s) Status:	Engineer sample
Channel numbers:	802.11b/802.11g /802.11n(HT20):11/ 802.11n(HT40):7
Operation Frequency:	802.11b/802.11g /802.11n(HT20): 2412-2462MHz 802.11n(HT40): 2422-2452MHz
Channel separation:	5MHz
Modulation technology:	IEEE 802.11b: DQPSK/DBPSK/DSSS/CCK IEEE 802.11g: QPSK/BPSK/16QAM/64QAM/OFDM IEEE 802.11n: QPSK/BPSK/16QAM/64QAM/OFDM
Antenna Type:	Monopole antenna
Antenna gain:	2.95dBi
Power supply:	Input: DC 12V/15A





Operation Frequency each of channel							
Channel	Frequency	Channel	Frequency	Channel	Frequency	Channel	Frequency
1	2412MHz	4	2427MHz	7	2442MHz	10	2457MHz
2	2417MHz	5	2432MHz	8	2447MHz	11	2462MHz
3	2422MHz	6	2437MHz	9	2452MHz	X	

**Note:**

In section 15.31(m), regards to the operating frequency range over 10 MHz, the Lowest frequency, the middle frequency, and the highest frequency of channel were selected to perform the test, and the selected channel see below:

Test channel	Frequency (MHz)	
	802.11b/802.11g/802.11n(HT20)	802.11n(HT40)
Lowest channel	2412MHz	2422MHz
Middle channel	2437MHz	2437MHz
Highest channel	2462MHz	2452MHz

**3.2 DESCRIPTION OF TEST MODES**

Transmitting mode	Keep the EUT in continuously transmitting mode
Remark: EUT use new battery during the test, the test voltage was tuned from 85% to 115% of the nominal rated supply voltage, and found that the worst case was under the nominal rated supply condition. So the report just shows that condition's data.	

We have verified the construction and function in typical operation. All the test modes were carried out with the EUT in transmitting operation, which was shown in this test report and defined as follows:				
Pre-scan all kind of data rate in lowest channel, and found the follow list which it was worst case.				
Mode	802.11b	802.11g	802.11n(HT20)	802.11n(HT40)
Data rate	1Mbps	6Mbps	6.5Mbps	13Mbps

**3.3 BLOCK DIGRAM SHOWING THE CONFIGURATION OF SYSTEM TESTED****Radiated Emission**



### 3.4 DESCRIPTION OF SUPPORT UNITS(CONDUCTED MODE)

The EUT has been tested as an independent unit together with other necessary accessories or support units. The following support units or accessories were used to form a representative test configuration during the tests.

Item	Equipment	Mfr/Brand	Model/Type No.	Series No.	Note
E-1	DC POWER SUPPLY	Sophpower Electronics Co., Ltd.	DSP100-100	/	AE

Item	Shielded Type	Ferrite Core	Length	Note

**Note:**

- (1) The support equipment was authorized by Declaration of Confirmation.
- (2) For detachable type I/O cable should be specified the length in cm in 『Length』 column.



## 3.5EQUIPMENTS LIST FOR ALL TEST ITEMS

## Radiation Test equipment

Item	Equipment	Manufacturer	Type No.	Serial No.	Firmware Version	Last calibration	Calibrated until
1	Spectrum Analyzer (9kHz-26.5GHz)	KEYSIGHT	9020A	MY55370835	A.17.05	Nov. 02, 2023	Nov. 01, 2024
2	Spectrum Analyzer (10kHz-39.9GHz)	R&S	FSV40-N	100363	1.71 SP2	Nov. 02, 2023	Nov. 01, 2024
3	EMI Test Receiver (9kHz-7GHz)	R&S	ESCI7	100969	4.32	Nov. 02, 2023	Nov. 01, 2024
4	Bilog Antenna (30MHz-1500MHz)	Schwarzbeck	VULB9168	N/A	N/A	Nov. 13, 2023	Nov. 12, 2024
5	Horn Antenna (1GHz-18GHz)	Agilent	AH-118	071145	N/A	Nov. 13, 2023	Nov. 12, 2024
6	Horn Antenna (15GHz-40GHz)	A.H.System	SAS-574	588	N/A	Nov. 13, 2023	Nov. 12, 2024
7	Loop Antenna	TESEQ	HLA6121	58357	N/A	Nov. 16, 2023	Nov. 15, 2024
8	Amplifier (30-1000MHz)	EM Electronics	EM330 Amplifier	60747	N/A	Nov. 02, 2023	Nov. 01, 2024
9	Amplifier (1GHz-26.5GHz)	HuiPu	8449B	3008A00315	N/A	Nov. 02, 2023	Nov. 01, 2024
10	Amplifier (500MHz-40GHz)	QuanJuDa	DLE-161	097	N/A	Nov. 02, 2023	Nov. 01, 2024
11	Test Cable	N/A	R-01	N/A	N/A	Nov. 02, 2023	Nov. 01, 2024
12	Test Cable	N/A	R-02	N/A	N/A	Nov. 02, 2023	Nov. 01, 2024
13	Test Cable	N/A	R-03	N/A	N/A	Nov. 02, 2023	Nov. 01, 2024
14	Test Cable	N/A	RF-01	N/A	N/A	Nov. 02, 2023	Nov. 01, 2024
15	Test Cable	N/A	RF-02	N/A	N/A	Nov. 02, 2023	Nov. 01, 2024
16	Test Cable	N/A	RF-03	N/A	N/A	Nov. 02, 2023	Nov. 01, 2024
17	ESG Signal Generator	Agilent	E4421B	N/A	B.03.84	Nov. 02, 2023	Nov. 01, 2024
18	Signal Generator	Agilent	N5182A	N/A	A.01.87	Nov. 02, 2023	Nov. 01, 2024
19	Magnetic Field Probe Tester	Narda	ELT-400	0-0344	N/A	Nov. 16, 2023	Nov. 15, 2024
20	Wideband Radio Communication Test	R&S	CMW500	106504	V 3.7.22	Nov. 02, 2023	Nov. 01, 2024
21	MWRF Power Meter Test system	MW	MW100-RF CB	N/A	N/A	Nov. 02, 2023	Nov. 01, 2024
22	D.C. Power Supply	LongWei	TPR-6405D	N/A	N/A	\	\
23	EMC Software	Frad	EZ-EMC	Ver.EMC-CO N 3A1.1	N/A	\	\
24	RF Software	MW	MTS8310	V2.0.0.0	N/A	\	\
25	Turntable	MF	MF-7802BS	N/A	N/A	\	\
26	Antenna tower	MF	MF-7802BS	N/A	N/A	\	\



Conduction Test equipment

Item	Kind of Equipment	Manufacturer	Type No.	Serial No.	Firmware Version	Last calibration	Calibrated until
1	LISN	R&S	ENV216	101471	N/A	Nov. 14, 2023	Nov. 13, 2024
2	LISN	CYBERTEK	EM5040A	E1850400149	N/A	Nov. 02, 2023	Nov. 01, 2024
3	Test Cable	N/A	C-01	N/A	N/A	Nov. 02, 2023	Nov. 01, 2024
4	Test Cable	N/A	C-02	N/A	N/A	Nov. 02, 2023	Nov. 01, 2024
5	Test Cable	N/A	C-03	N/A	N/A	Nov. 02, 2023	Nov. 01, 2024
6	EMI Test Receiver	R&S	ESCI3	101393	4.42 SP3	Nov. 02, 2023	Nov. 01, 2024
7	Triple-Loop Antenna	N/A	RF300	N/A	N/A	Nov. 02, 2023	Nov. 01, 2024
8	Absorbing Clamp	DZ	ZN23201	15034	N/A	Nov. 07, 2023	Nov. 06, 2024
9	EMC Software	Frad	EZ-EMC	Ver.EMC-CON 3A1.1	N/A	\	\



#### 4. EMC EMISSION TEST

##### 4.1 CONDUCTED EMISSION MEASUREMENT

Test Requirement:	FCC Part15 C Section 15.207
Test Method:	ANSI C63.10:2013
Test Frequency Range:	150KHz to 30MHz
Receiver setup:	RBW=9KHz, VBW=30KHz, Sweep time=auto

##### 4.1.1 POWER LINE CONDUCTED EMISSION Limits

FREQUENCY (MHz)	Limit (dBuV)		Standard
	Quasi-peak	Average	
0.15 -0.5	66 - 56 *	56 - 46 *	FCC
0.50 -5.0	56.00	46.00	FCC
5.0 -30.0	60.00	50.00	FCC

Note:

(1) \*Decreases with the logarithm of the frequency.

##### 4.1.2 TEST PROCEDURE

- a. The EUT was placed 0.8 meters from the horizontal ground plane with EUT being connected to the power mains through a line impedance stabilization network (LISN). All other support equipments powered from additional LISN(s). The LISN provide 50 Ohm/ 50uH of coupling impedance for the measuring instrument.
- b. Interconnecting cables that hang closer than 40 cm to the ground plane shall be folded back and forth in the center forming a bundle 30 to 40 cm long.
- c. I/O cables that are not connected to a peripheral shall be bundled in the center. The end of the cable may be terminated, if required, using the correct terminating impedance. The overall length shall not exceed 1 m.
- d. LISN at least 80 cm from nearest part of EUT chassis.
- e. For the actual test configuration, please refer to the related Item –EUT Test Photos.

##### 4.1.3 DEVIATION FROM TEST STANDARD

No deviation



#### 4.1.4 TEST SETUP

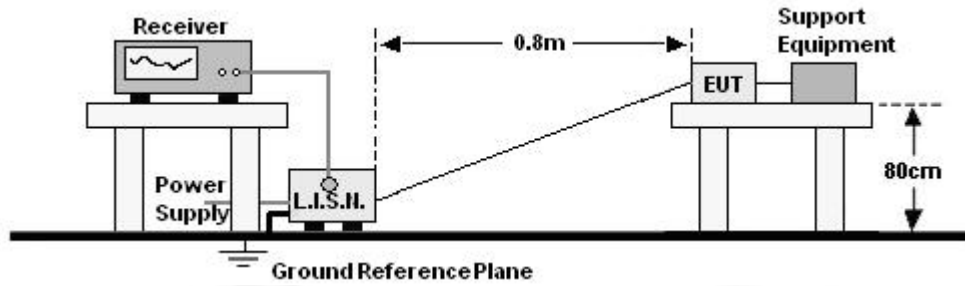

#### 4.1.5 EUT OPERATING CONDITIONS

The EUT was configured for testing in a typical fashion (as a customer would normally use it). The EUT has been programmed to continuously transmit during test. This operating condition was tested and used to collect the included data.

#### 4.1.6 TEST RESULT

The EUT is a Car Navigation Multimedia and powered by the DC only, the test item is not applicable.



#### 4.2 RADIATED EMISSION MEASUREMENT

Test Requirement:	FCC Part15 C Section 15.209				
Test Method:	ANSI C63.10:2013				
Test Frequency Range:	9kHz to 25GHz				
Test site:	Measurement Distance: 3m				
Receiver setup:	Frequency	Detector	RBW	VBW	Value
	9KHz-150KHz	Quasi-peak	200Hz	600Hz	Quasi-peak
	150KHz-30MHz	Quasi-peak	9KHz	30KHz	Quasi-peak
	30MHz-1GHz	Quasi-peak	100KHz	300KHz	Quasi-peak
	Above 1GHz	Peak	1MHz	3MHz	Peak
Peak		1MHz	10Hz	Average	

#### 4.2.1 RADIATED EMISSION LIMITS

Frequencies (MHz)	Field Strength (micorvolts/meter)	Measurement Distance (meters)
0.009~0.490	2400/F(KHz)	300
0.490~1.705	24000/F(KHz)	30
1.705~30.0	30	30
30~88	100	3
88~216	150	3
216~960	200	3
Above 960	500	3

#### LIMITS OF RADIATED EMISSION MEASUREMENT

FREQUENCY (MHz)	Limit (dBuV/m) (at 3M)	
	PEAK	AVERAGE
Above 1000	74	54

Notes:

- (1) The limit for radiated test was performed according to FCC PART 15C.
- (2) The tighter limit applies at the band edges.
- (3) Emission level (dBuV/m)=20log Emission level (uV/m).

#### 4.2.2 TEST PROCEDURE

Below 1GHz test procedure as below:

- a. The EUT was placed on the top of a rotating table 0.8 meters above the ground at a 3 meter semi-anechoiccamber. The table was rotated 360 degrees to determine the position of the highest radiation.
- b. The EUT was set 3 meters away from the interference-receiving antenna, which was mounted on the top of available-height antenna tower.



- c. The antenna height is varied from one meter to four meters above the ground to determine the maximum value of the field strength. Both horizontal and vertical polarizations of the antenna are set to make the measurement.
- d. For each suspected emission, the EUT was arranged to its worst case and then the antenna was tuned to heights from 1 meter to 4 meters (for the test frequency of below 30MHz, the antenna was tuned to heights 1meter) and the rotatable table was turned from 0 degrees to 360 degrees to find the maximum reading.
- e. The test-receiver system was set to Peak Detect Function and Specified Bandwidth with Maximum Hold Mode.
- f. If the emission level of the EUT in peak mode was 10dB lower than the limit specified, then testing could be stopped and the peak values of the EUT would be reported. Otherwise the emissions that did not have 10dBmargin would be re-tested one by one using peak, quasi-peak or average method as specified and then reported in a data sheet.

Above 1GHz test procedure as below:

- g. Different between above is the test site, change from Semi- Anechoic Chamber to fully Anechoic Chamber and change form table 0.8 meter to 1.5 meter( Above 18GHz the distance is 1 meter and table is 1.5 meter).
- h. Test the EUT in the lowest channel ,the middle channel ,the Highest channel

Note:

Both horizontal and vertical antenna polarities were tested and performed pretest to three orthogonal axis. The worst case emissions were reported

#### 4.2.3 DEVIATION FROM TEST STANDARD

No deviation

#### 4.2.4 TEST SETUP

(A) Radiated Emission Test-Up Frequency Below 30MHz

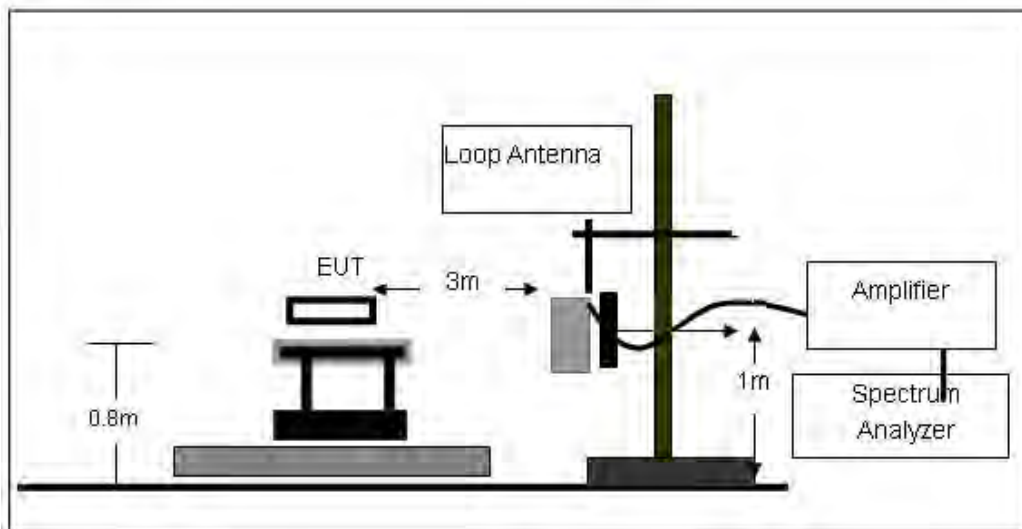





(B) Radiated Emission Test-Up Frequency 30MHz~1GHz

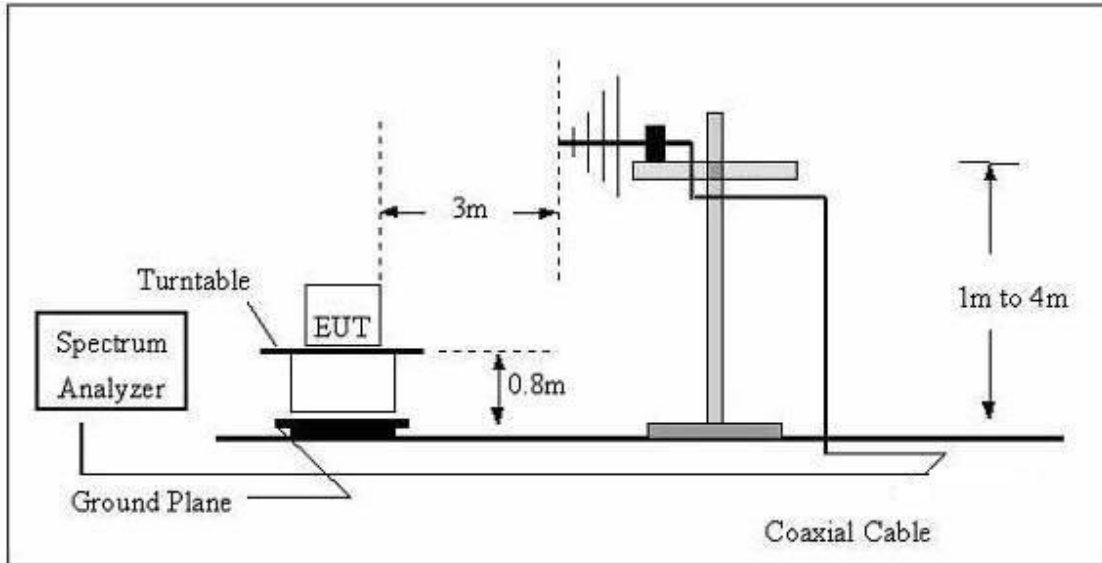

(C) Radiated Emission Test-Up Frequency Above 1GHz

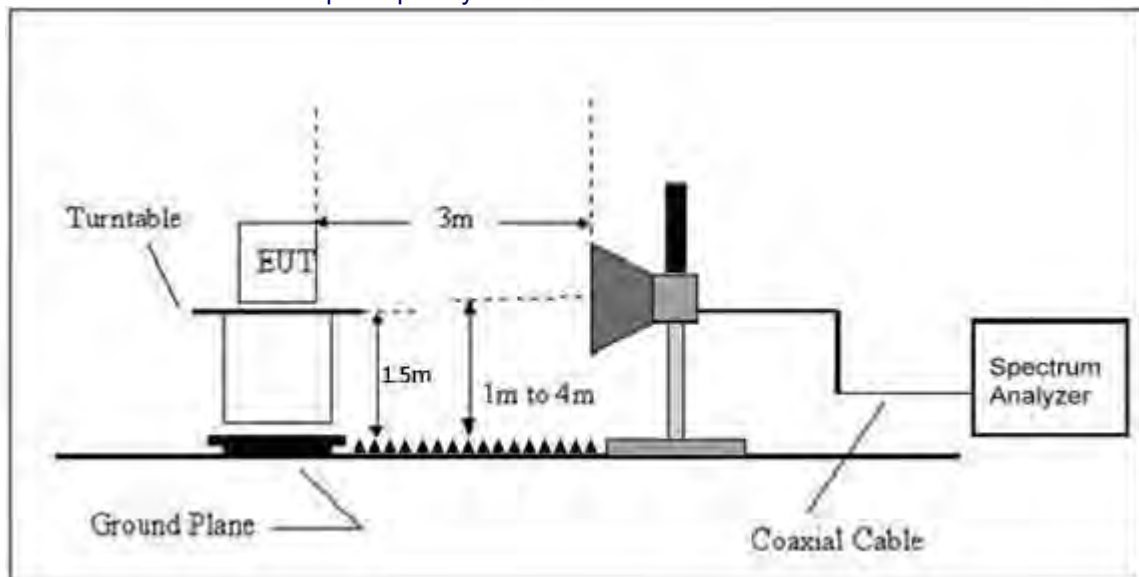

#### 4.2.5 EUT OPERATING CONDITIONS

The EUT tested system was configured as the statements of 2.4 Unless otherwise a special operating condition is specified in the follows during the testing.

#### 4.2.6 TEST RESULTS

Between 9KHz – 30MHz

The emission from 9 kHz to 30MHz was pre-tested and found the result was 20dB lower than the limit, and according to 15.31(o) & RSS-Gen 6.13, the test result no need to reported.



Between 30MHz – 1GHz

Temperature :	25.1°C	Relative Humidity :	50%
Pressure :	101kPa	Polarization :	Horizontal
Test Voltage :	AC120/60Hz		

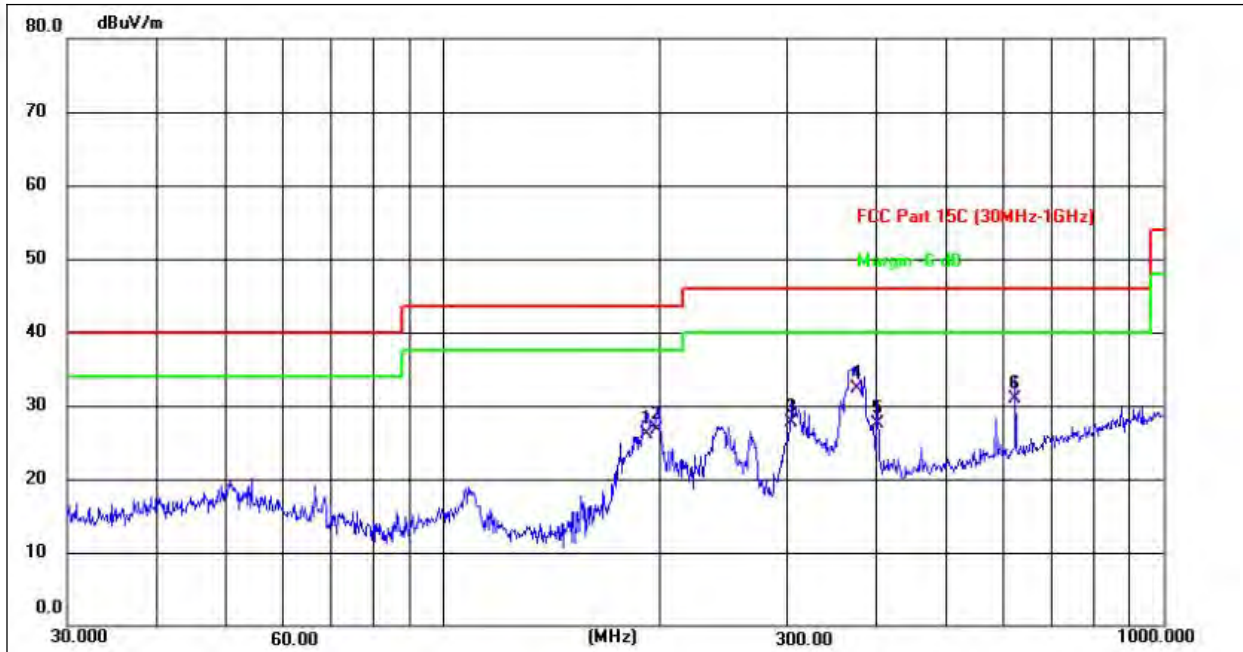

No.	Frequency (MHz)	Reading (dBuV)	Factor (dB/m)	Level (dBuV/m)	Limit (dBuV/m)	Margin (dB)	Detector
1	191.0738	37.69	-11.54	26.15	43.50	-17.35	QP
2	197.8926	37.68	-11.04	26.64	43.50	-16.86	QP
3	304.6099	35.60	-7.94	27.66	46.00	-18.34	QP
4 *	374.6225	38.60	-6.34	32.26	46.00	-13.74	QP
5	400.4318	33.29	-5.75	27.54	46.00	-18.46	QP
6	622.8900	32.76	-1.90	30.86	46.00	-15.14	QP



Temperature :	25.1°C	Relative Humidity :	50%
Pressure :	101kPa	Polarization :	Vertical
Test Voltage :	AC120/60Hz		

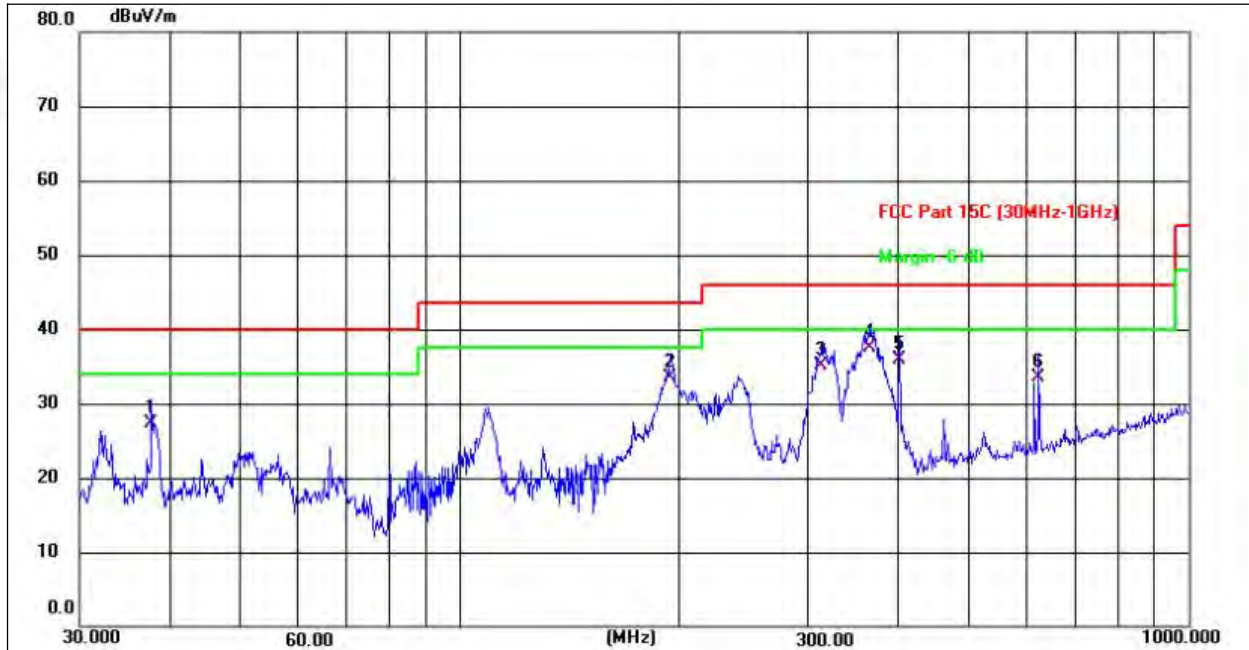

No.	Frequency (MHz)	Reading (dBuV)	Factor (dB/m)	Level (dBuV/m)	Limit (dBuV/m)	Margin (dB)	Detector
1	37.6796	37.43	-10.10	27.33	40.00	-12.67	QP
2	193.7726	44.94	-11.34	33.60	43.50	-9.90	QP
3	313.2760	42.79	-7.74	35.05	46.00	-10.95	QP
4 *	365.5390	44.06	-6.55	37.51	46.00	-8.49	QP
5	400.4318	41.63	-5.75	35.88	46.00	-10.12	QP
6	622.8900	35.46	-1.90	33.56	46.00	-12.44	QP

Remarks:

1. Final Level = Receiver Read level + Antenna Factor + Cable Loss – Preamplifier Factor
2. The emission levels of other frequencies are very lower than the limit and not show in test report.
3. The test data shows only the worst case 802.11N40 mode ( High Channel:2452MHz).



## 1GHz~25GHz

Polar (H/V)	Frequency	Meter Reading	Pre-amplifier	Cable Loss	Antenna Factor	Emission Level	Limits	Margin	Detect or Type
	(MHz)	(dBuV)	(dB)	(dB)	(dB)	(dBuV/m)	(dBuV/m)	(dB)	
802.11b									
Low Channel:2412MHz									
V	4824.00	57.81	30.55	5.77	24.66	57.69	74	-16.31	Pk
V	4824.00	41.84	30.55	5.77	24.66	41.72	54	-12.28	AV
H	4824.00	58.41	30.33	6.32	24.55	58.95	74	-15.05	Pk
H	4824.00	44.64	30.33	6.32	24.55	45.18	54	-8.82	AV
Middle Channel:2437MHz									
V	4874.00	59.73	30.55	5.77	24.66	59.61	74	-14.39	Pk
V	4874.00	43.97	30.55	5.77	24.66	43.85	54	-10.15	AV
H	4874.00	55.33	30.33	6.32	24.55	55.87	74	-18.13	Pk
H	4874.00	41.73	30.33	6.32	24.55	42.27	54	-11.73	AV
High Channel:2462MHz									
V	4924.00	57.97	30.55	5.77	24.66	57.85	74	-16.15	Pk
V	4924.00	41.48	30.55	5.77	24.66	41.36	54	-12.64	AV
H	4924.00	58.66	30.33	6.32	24.55	59.2	74	-14.8	Pk
H	4924.00	41.95	30.33	6.32	24.55	42.49	54	-11.51	AV
802.11g									
Low Channel:2412MHz									
V	4824.00	59.59	30.55	5.77	24.66	59.47	74	-14.53	Pk
V	4824.00	41.67	30.55	5.77	24.66	41.55	54	-12.45	AV
H	4824.00	59.79	30.33	6.32	24.55	60.33	74	-13.67	Pk
H	4824.00	41.51	30.33	6.32	24.55	42.05	54	-11.95	AV
Middle Channel:2437MHz									
V	4874.00	57.03	30.55	5.77	24.66	56.91	74	-17.09	Pk
V	4874.00	41	30.55	5.77	24.66	40.88	54	-13.12	AV
H	4874.00	55.16	30.33	6.32	24.55	55.7	74	-18.3	Pk
H	4874.00	44.33	30.33	6.32	24.55	44.87	54	-9.13	AV
High Channel:2462MHz									
V	4924.00	57.22	30.55	5.77	24.66	57.1	74	-16.9	Pk
V	4924.00	44.33	30.55	5.77	24.66	44.21	54	-9.79	AV
H	4924.00	56.36	30.33	6.32	24.55	56.9	74	-17.1	Pk
H	4924.00	43.39	30.33	6.32	24.55	43.93	54	-10.07	AV
802.11n 20									
Low Channel:2412MHz									
V	4824.00	59.94	30.55	5.77	24.66	59.82	74	-14.18	Pk
V	4824.00	41.57	30.55	5.77	24.66	41.45	54	-12.55	AV
H	4824.00	58.61	30.33	6.32	24.55	59.15	74	-14.85	Pk
H	4824.00	42	30.33	6.32	24.55	42.54	54	-11.46	AV
Middle Channel:2437MHz									
V	4874.00	58.45	30.55	5.77	24.66	58.33	74	-15.67	Pk
V	4874.00	44.39	30.55	5.77	24.66	44.27	54	-9.73	AV
H	4874.00	57.38	30.33	6.32	24.55	57.92	74	-16.08	Pk
H	4874.00	41.62	30.33	6.32	24.55	42.16	54	-11.84	AV
High Channel:2462MHz									
V	4924.00	55.59	30.55	5.77	24.66	55.47	74	-18.53	Pk
V	4924.00	41.69	30.55	5.77	24.66	41.57	54	-12.43	AV
H	4924.00	57.89	30.33	6.32	24.55	58.43	74	-15.57	Pk
H	4924.00	44.38	30.33	6.32	24.55	44.92	54	-9.08	AV
802.11n 40									
Low Channel:2422MHz									
V	4844.00	57.21	30.55	5.77	24.66	57.09	74	-16.91	Pk
V	4844.00	41.27	30.55	5.77	24.66	41.15	54	-12.85	AV



H	4844.00	59.9	30.33	6.32	24.55	60.44	74	-13.56	Pk
H	4844.00	41.91	30.33	6.32	24.55	42.45	54	-11.55	AV
Middle Channel:2437MHz									
V	4874.00	59.78	30.55	5.77	24.66	59.66	74	-14.34	Pk
V	4874.00	41.06	30.55	5.77	24.66	40.94	54	-13.06	AV
H	4874.00	55.21	30.33	6.32	24.55	55.75	74	-18.25	Pk
H	4874.00	41.79	30.33	6.32	24.55	42.33	54	-11.67	AV
High Channel:2452MHz									
V	4904.00	57.17	30.55	5.77	24.66	57.05	74	-16.95	Pk
V	4904.00	41.97	30.55	5.77	24.66	41.85	54	-12.15	AV
H	4904.00	58.92	30.33	6.32	24.55	59.46	74	-14.54	Pk
H	4904.00	43.44	30.33	6.32	24.55	43.98	54	-10.02	AV

**Remark:**

1. Emission Level = Meter Reading + Antenna Factor + Cable Loss – Pre-amplifier,  
Margin= Emission Level - Limit
2. If peak below the average limit, the average emission was no test.
3. The amplitude of spurious emissions which are attenuated by more than 20dB below the permissible value has no need to be reported.
4. For above 1GHz, the test result of peak was 20dB below to the limit of peak, which can be compliant to the average limit, so just peak value was recorded.



## 5. RADIATED BAND EMISSION MEASUREMENT

### 5.1 TEST REQUIREMENT:

Test Requirement:	FCC Part15 C Section 15.209 and 15.205				
Test Method:	ANSI C63.10: 2013				
Test Frequency Range:	All of the restrict bands were tested, only the worst band's (2310MHz to 2500MHz) data was showed.				
Test site:	Measurement Distance: 3m				
Receiver setup:	Frequency	Detector	RBW	VBW	Value
	Above 1GHz	Peak	1MHz	3MHz	Peak
		Average	1MHz	3MHz	Average

### LIMITS OF RADIATED EMISSION MEASUREMENT (Above 1000MHz)

FREQUENCY (MHz)	Class B (dBuV/m) (at 3M)	
	PEAK	AVERAGE
Above 1000	74	54

Notes:

- (1) The limit for radiated test was performed according to FCC PART 15C.
- (2) The tighter limit applies at the band edges.
- (3) Emission level (dBuV/m)=20log Emission level (uV/m).

### 5.2 TEST PROCEDURE

Above 1GHz test procedure as below:

- a. 1. The EUT was placed on the top of a rotating table 1.5 meters above the ground at a 3 meter camber. The table was rotated 360 degrees to determine the position of the highest radiation.
- b. The EUT was set 3 meters away from the interference-receiving antenna, which was mounted on the top of a variable-height antenna tower.
- c. The antenna height is varied from one meter to four meters above the ground to determine the maximum value of the field strength. Both horizontal and vertical polarizations of the antenna are set to make the measurement.
- d. For each suspected emission, the EUT was arranged to its worst case and then the antenna was tuned to heights from 1 meter to 4 meters and the rota table was turned from 0 degrees to 360 degrees to find the maximum reading.
- e. The test-receiver system was set to Peak Detect Function and Specified Bandwidth with Maximum Hold Mode.
- f. If the emission level of the EUT in peak mode was 10dB lower than the limit specified, then testing could be stopped and the peak values of the EUT would be reported. Otherwise the emissions that did not have 10dBmargin would be re-tested one by one using peak, quasi-peak or average method as specified and then reported in a data sheet.
- g. Test the EUT in the lowest channel,the Highest channel

Note:

Both horizontal and vertical antenna polarities were tested and performed pretest to three orthogonal axis. The worst case emissions were reported

### 5.3 DEVIATION FROM TEST STANDARD

No deviation



## 5.4 TEST SETUP

### Radiated Emission Test-Up Frequency Above 1GHz

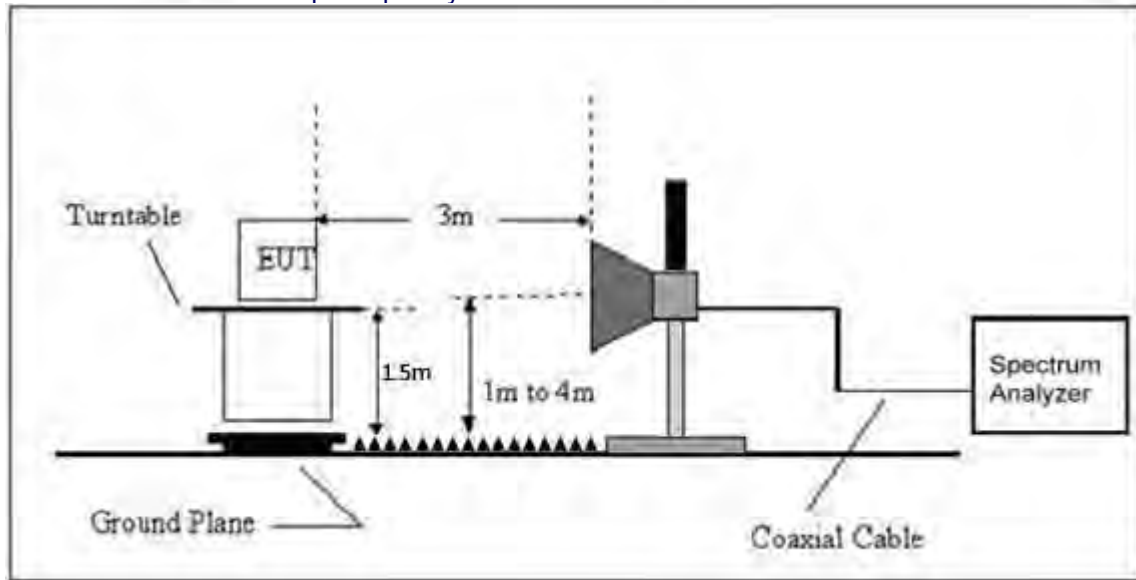

## 5.5 EUT OPERATING CONDITIONS

The EUT tested system was configured as the statements of 2.3 Unless otherwise a special operating condition is specified in the follows during the testing.



## 5.6 TEST RESULT

	Polar (H/V)	Frequency (MHz)	Meter Reading (dBuV)	Pre-amplifier (dB)	Cable Loss (dB)	Antenna Factor (dB/m)	Emission level (dBuV/m)	Limit (dBuV/m)	Margin (dB)	Detector Type	Result
802.11b	Low Channel 2412MHz										
	H	2390.00	61.44	30.22	4.85	23.98	60.05	74.00	-13.95	PK	PASS
	H	2390.00	47.87	30.22	4.85	23.98	46.48	54.00	-7.52	AV	PASS
	H	2400.00	60.36	30.22	4.85	23.98	58.97	74.00	-15.03	PK	PASS
	H	2400.00	47.60	30.22	4.85	23.98	46.21	54.00	-7.79	AV	PASS
	V	2390.00	60.81	30.22	4.85	23.98	59.42	74.00	-14.58	PK	PASS
	V	2390.00	48.97	30.22	4.85	23.98	47.58	54.00	-6.42	AV	PASS
	V	2400.00	62.60	30.22	4.85	23.98	61.21	74.00	-12.79	PK	PASS
	V	2400.00	46.68	30.22	4.85	23.98	45.29	54.00	-8.71	AV	PASS
	High Channel 2462MHz										
	H	2483.50	62.27	30.22	4.85	23.98	60.88	74.00	-13.12	AV	PASS
	H	2483.50	47.01	30.22	4.85	23.98	45.62	54.00	-8.38	PK	PASS
	H	2500.00	60.70	30.22	4.85	23.98	59.31	74.00	-14.69	AV	PASS
	H	2500.00	47.65	30.22	4.85	23.98	46.26	54.00	-7.74	PK	PASS
	V	2483.50	62.28	30.22	4.85	23.98	60.89	74.00	-13.11	AV	PASS
	V	2483.50	46.80	30.22	4.85	23.98	45.41	54.00	-8.59	PK	PASS
V	2500.00	61.49	30.22	4.85	23.98	60.10	74.00	-13.90	AV	PASS	
V	2500.00	48.98	30.22	4.85	23.98	47.59	54.00	-6.41	AV	PASS	
802.11g	Low Channel 2412MHz										
	H	2390.00	62.04	30.22	4.85	23.98	60.65	74.00	-13.35	PK	PASS
	H	2390.00	48.10	30.22	4.85	23.98	46.71	54.00	-7.29	AV	PASS
	H	2400.00	61.73	30.22	4.85	23.98	60.34	74.00	-13.66	PK	PASS
	H	2400.00	48.55	30.22	4.85	23.98	47.16	54.00	-6.84	AV	PASS
	V	2390.00	59.13	30.22	4.85	23.98	57.74	74.00	-16.26	PK	PASS
	V	2390.00	48.93	30.22	4.85	23.98	47.54	54.00	-6.46	AV	PASS
	V	2400.00	61.28	30.22	4.85	23.98	59.89	74.00	-14.11	PK	PASS
	V	2400.00	46.46	30.22	4.85	23.98	45.07	54.00	-8.93	AV	PASS
	High Channel 2462MHz										
	H	2483.50	62.99	30.22	4.85	23.98	61.60	74.00	-12.40	PK	PASS
	H	2483.50	48.96	30.22	4.85	23.98	47.57	54.00	-6.43	AV	PASS
	H	2500.00	62.30	30.22	4.85	23.98	60.91	74.00	-13.09	PK	PASS
	H	2500.00	48.62	30.22	4.85	23.98	47.23	54.00	-6.77	AV	PASS
	V	2483.50	60.89	30.22	4.85	23.98	59.50	74.00	-14.50	PK	PASS
	V	2483.50	48.20	30.22	4.85	23.98	46.81	54.00	-7.19	AV	PASS
V	2500.00	60.02	30.22	4.85	23.98	58.63	74.00	-15.37	PK	PASS	
V	2500.00	46.01	30.22	4.85	23.98	44.62	54.00	-9.38	AV	PASS	
802.11n 20	Low Channel 2412MHz										
	H	2390.00	59.03	30.22	4.85	23.98	57.64	74.00	-16.36	PK	PASS
	H	2390.00	48.93	30.22	4.85	23.98	47.54	54.00	-6.46	AV	PASS
	H	2400.00	61.20	30.22	4.85	23.98	59.81	74.00	-14.19	PK	PASS
	H	2400.00	46.65	30.22	4.85	23.98	45.26	54.00	-8.74	AV	PASS
	V	2390.00	59.87	30.22	4.85	23.98	58.48	74.00	-15.52	PK	PASS
	V	2390.00	46.95	30.22	4.85	23.98	45.56	54.00	-8.44	AV	PASS
	V	2400.00	60.72	30.22	4.85	23.98	59.33	74.00	-14.67	PK	PASS
	V	2400.00	48.32	30.22	4.85	23.98	46.93	54.00	-7.07	AV	PASS
	High Channel 2462MHz										
	H	2483.50	62.76	30.22	4.85	23.98	61.37	74.00	-12.63	PK	PASS
	H	2483.50	48.70	30.22	4.85	23.98	47.31	54.00	-6.69	AV	PASS
	H	2500.00	61.02	30.22	4.85	23.98	59.63	74.00	-14.37	PK	PASS
	H	2500.00	46.92	30.22	4.85	23.98	45.53	54.00	-8.47	AV	PASS
	V	2483.50	62.04	30.22	4.85	23.98	60.65	74.00	-13.35	PK	PASS





	V	2483.50	46.26	30.22	4.85	23.98	44.87	54.00	-9.13	AV	PASS
	V	2500.00	59.92	30.22	4.85	23.98	58.53	74.00	-15.47	PK	PASS
	V	2500.00	47.83	30.22	4.85	23.98	46.44	54.00	-7.56	AV	PASS
	Low Channel 2422MHz										
	H	2390.00	59.61	30.22	4.85	23.98	58.22	74.00	-15.78	PK	PASS
	H	2390.00	48.71	30.22	4.85	23.98	47.32	54.00	-6.68	AV	PASS
	H	2400.00	59.36	30.22	4.85	23.98	57.97	74.00	-16.03	PK	PASS
	H	2400.00	48.57	30.22	4.85	23.98	47.18	54.00	-6.82	AV	PASS
	V	2390.00	61.49	30.22	4.85	23.98	60.10	74.00	-13.90	PK	PASS
	V	2390.00	48.18	30.22	4.85	23.98	46.79	54.00	-7.21	AV	PASS
	V	2400.00	59.93	30.22	4.85	23.98	58.54	74.00	-15.46	PK	PASS
	V	2400.00	47.38	30.22	4.85	23.98	45.99	54.00	-8.01	AV	PASS
	High Channel 2452MHz										
	H	2483.50	62.17	30.22	4.85	23.98	60.78	74.00	-13.22	PK	PASS
	H	2483.50	48.60	30.22	4.85	23.98	47.21	54.00	-6.79	AV	PASS
	H	2500.00	60.44	30.22	4.85	23.98	59.05	74.00	-14.95	PK	PASS
	H	2500.00	46.27	30.22	4.85	23.98	44.88	54.00	-9.12	AV	PASS
	V	2483.50	59.39	30.22	4.85	23.98	58.00	74.00	-16.00	PK	PASS
	V	2483.50	47.14	30.22	4.85	23.98	45.75	54.00	-8.25	AV	PASS
	V	2500.00	62.36	30.22	4.85	23.98	60.97	74.00	-13.03	PK	PASS
	V	2500.00	48.34	30.22	4.85	23.98	46.95	54.00	-7.05	AV	PASS

**Remark:**

1. Emission Level = Meter Reading + Antenna Factor + Cable Loss – Pre-amplifier, Margin= Emission Level - Limit



## 6. POWER SPECTRAL DENSITY TEST

Test Requirement:	FCC Part15 C Section 15.247 (e)
Test Method:	KDB558074 D0115.247 Meas Guidancev05r02

### 6.1 APPLIED PROCEDURES / LIMIT

FCC Part15 (15.247) , Subpart C				
Section	Test Item	Limit	Frequency Range (MHz)	Result
15.247	Power Spectral Density	8dBm/3kHz	2400-2483.5	PASS

### 6.2 TEST PROCEDURE

1. Set analyzer center frequency to DTS channel center frequency.
2. Set the span to 1.5 times the DTS bandwidth.
3. Set the RBW to:  $3 \text{ kHz} \leq \text{RBW} \leq 100 \text{ kHz}$ .
4. Set the VBW  $\geq 3 \times \text{RBW}$ .
5. Detector = peak.
6. Sweep time = auto couple.
7. Trace mode = max hold.
8. Allow trace to fully stabilize.
9. Use the peak marker function to determine the maximum amplitude level within the RBW.
10. If measured value exceeds limit, reduce RBW (no less than 3 kHz) and repeat.

### 6.3 DEVIATION FROM STANDARD

No deviation.

### 6.4 TEST SETUP



### 6.5 EUT OPERATION CONDITIONS

The EUT tested system was configured as the statements of 2.1 Unless otherwise a special operating condition is specified in the follows during the testing.



### 6.6 TEST RESULT

Temperature :	25.9°C	Relative Humidity :	52%
Pressure :	101kPa	Test Voltage :	DC 12V

Please refer to APPENDIX WIFI



## 7. CHANNEL BANDWIDTH

Test Requirement:	FCC Part15 C Section 15.247 (a)(2)
Test Method:	KDB558074 D0115.247 Meas Guidancev05r02

### 7.1 APPLIED PROCEDURES / LIMIT

FCC Part15 (15.247) , Subpart C				
Section	Test Item	Limit	Frequency Range (MHz)	Result
15.247(a)(2)	Bandwidth	$\geq 500\text{KHz}$ (6dB bandwidth)	2400-2483.5	PASS

### 7.2 TEST PROCEDURE

1. Set RBW = 100 kHz.
2. Set the video bandwidth (VBW)  $\geq 3 \times$  RBW.
3. Detector = Peak.
4. Trace mode = max hold.
5. Sweep = auto couple.
6. Allow the trace to stabilize.
7. Measure the maximum width of the emission that is constrained by the frequencies associated with the two outermost amplitude points (upper and lower frequencies) that are attenuated by 6 dB relative to the maximum level measured in the fundamental emission.

### 7.3 DEVIATION FROM STANDARD

No deviation.

### 7.4 TEST SETUP



### 7.5 EUT OPERATION CONDITIONS

The EUT tested system was configured as the statements of 2.4 Unless otherwise a special operating condition is specified in the follows during the testing.



### 7.6 TEST RESULT

Temperature :	25.8°C	Relative Humidity :	52%
Pressure :	101kPa	Test Voltage :	DC 12V
Test Mode :	TX Mode		

Please refer to APPENDIX WIFI



### 8. OUTPUT POWER TEST

Test Requirement:	FCC Part15 C Section 15.247 (b)(3)
Test Method:	KDB558074 D0115.247 Meas Guidancev05r02

#### 8.1 APPLIED PROCEDURES/LIMIT

FCC Part15 (15.247) , Subpart C				
Section	Test Item	Limit	Frequency Range (MHz)	Result
15.247(b)(3)	Output Power	1 watt or 30dBm	2400-2483.5	PASS

#### 8.2 TEST PROCEDURE

- a. The EUT was directly connected to the Power meter

#### 8.3 DEVIATION FROM STANDARD

No deviation.

#### 8.4 TEST SETUP



#### 8.5 EUT OPERATION CONDITIONS

The EUT tested system was configured as the statements of 2.4 Unless otherwise a special operating condition is specified in the follows during the testing.

#### 8.6 TEST RESULT

Temperature :	25.3°C	Relative Humidity :	55%
Pressure :	101kPa	Test Voltage :	DC 12V



## 9. CONDUCTED BAND EDGE AND SPURIOUS EMISSION

Test Requirement:	FCC Part15 C Section 15.247 (d)
Test Method:	KDB558074 D0115.247 Meas Guidancev05r02

### 9.1 APPLICABLE STANDARD

in any 100 kHz bandwidth outside the frequency bands in which the spread spectrum intentional radiator is operating, the radio frequency power that is produced by the intentional radiator shall be at least 20dB below that in the 100kHz bandwidth within the band that contains the highest level of the desired power, In addition, radiated emissions which fall in the restricted bands, as defined in§15.205(a), must also comply with the radiated emission limits specified in15.209(a).

### 9.2 TEST PROCEDURE

Using the following spectrum analyzer setting:

- A) Set the RBW = 100KHz.
- B) Set the VBW = 300KHz.
- C) Sweep time = auto couple.
- D) Detector function = peak.
- E) Trace mode = max hold.
- F) Allow trace to fully stabilize.

### 9.3 DEVIATION FROM STANDARD

No deviation.

### 9.4 TEST SETUP



### 9.5 EUT OPERATION CONDITIONS

The EUT tested system was configured as the statements of 2.4 Unless otherwise a special operating condition is specified in the follows during the testing.

### 9.6 TEST RESULTS

Please refer to APPENDIX WIFI



## 10. ANTENNA REQUIREMENT

Standard requirement:	FCC Part15 C Section 15.203 /247(b)(4)
15.203 requirement: An intentional radiator shall be designed to ensure that no antenna other than that furnished by the responsible party shall be used with the device. The use of a permanently attached antenna or of an antenna that uses a unique coupling to the intentional radiator, the manufacturer may design the unit so that a broken antenna can be replaced by the user, but the use of a standard antenna jack or electrical connector is prohibited.	
15.247(b) (4) requirement: (4) The conducted output power limit specified in paragraph (b) of this section is based on the use of antennas with directional gains that do not exceed 6 dBi. Except as shown in paragraph (c) of this section, if transmitting antennas of directional gain greater than 6 dBi are used, the conducted output power from the intentional radiator shall be reduced below the stated values in paragraphs (b)(1), (b)(2), and (b)(3) of this section, as appropriate, by the amount in dB that the directional gain of the antenna exceeds 6 dBi.	
EUT Antenna: The antenna is Monopole antenna, the best case gain of the antenna is 2.95dBi, reference to the appendix II for details	





## 11. APPENDIX WIFI

### 11.1 DUTY CYCLE

Mode	Frequency (MHz)	Duty Cycle (%)	Correction Factor (dB)	1/T (kHz)
b	2412	98.94	0	0.12
b	2437	98.94	0	0.12
b	2462	98.82	0	0.12
g	2412	93.92	0.27	0.72
g	2437	93.96	0.27	0.71
g	2462	93.96	0.27	0.71
n20	2412	94.24	0.26	0.76
n20	2437	93.57	0.29	0.76
n20	2462	94.24	0.26	0.76
n40	2422	87.84	0.56	1.54
n40	2437	87.84	0.56	1.54
n40	2452	87.84	0.56	1.54

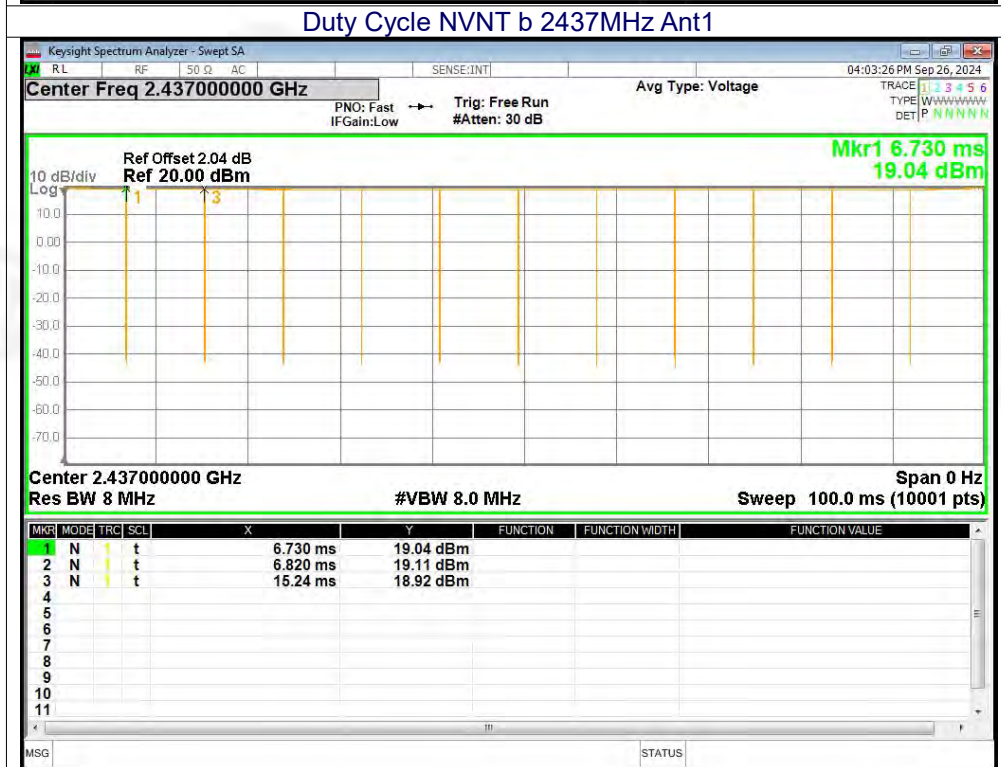
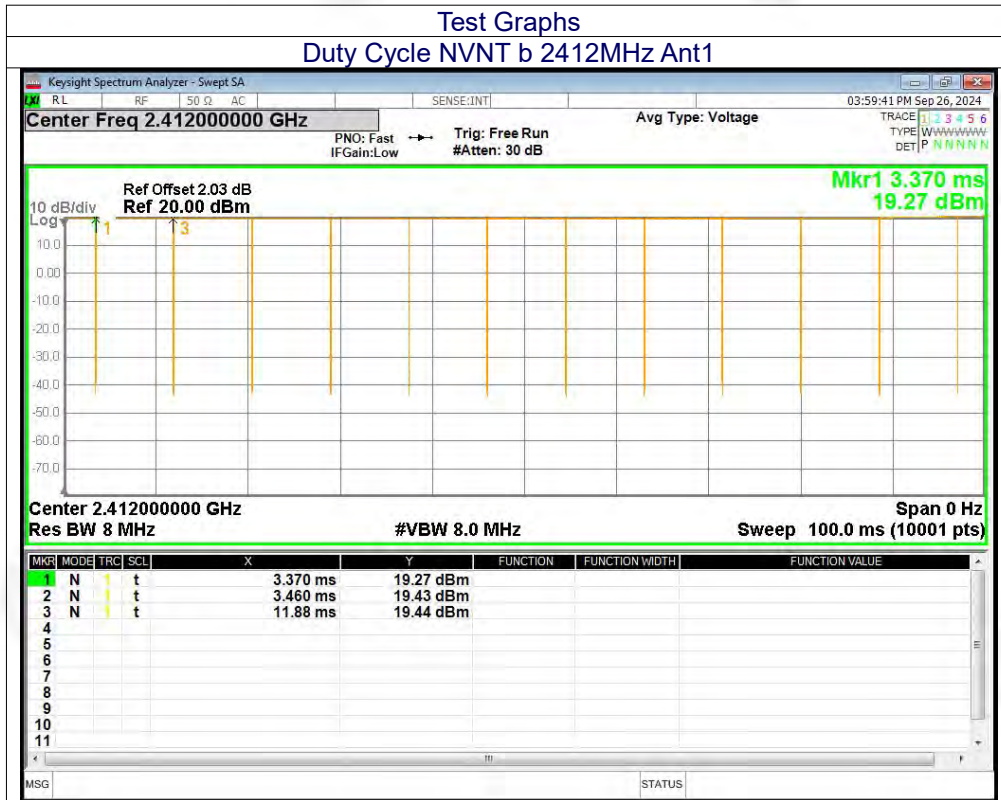

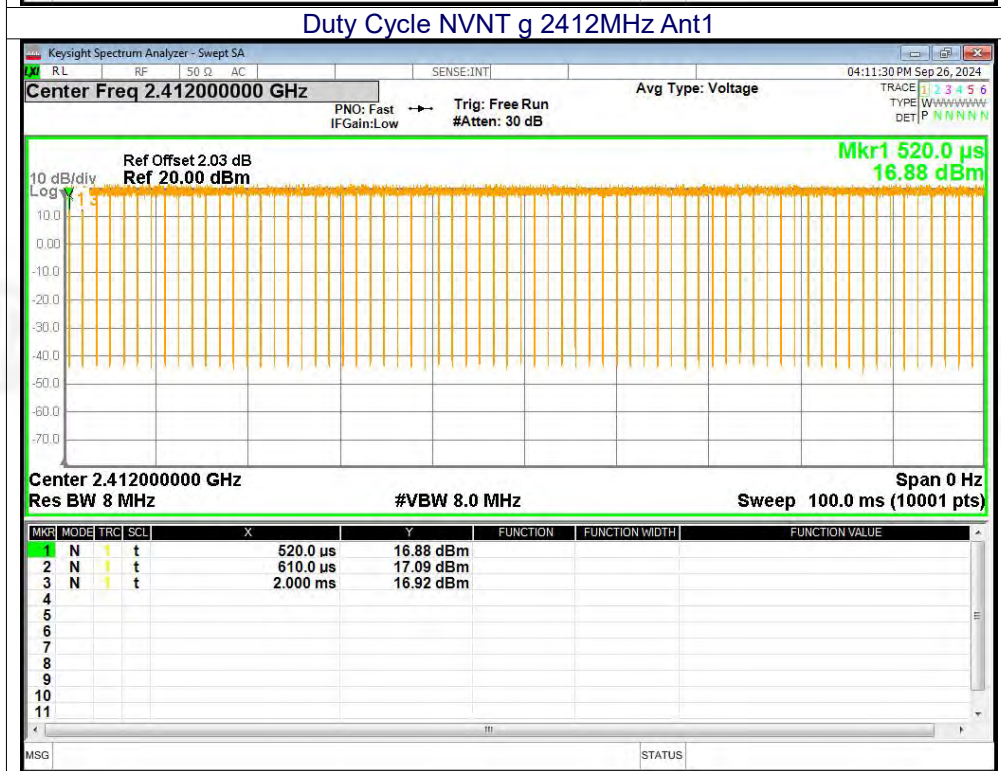
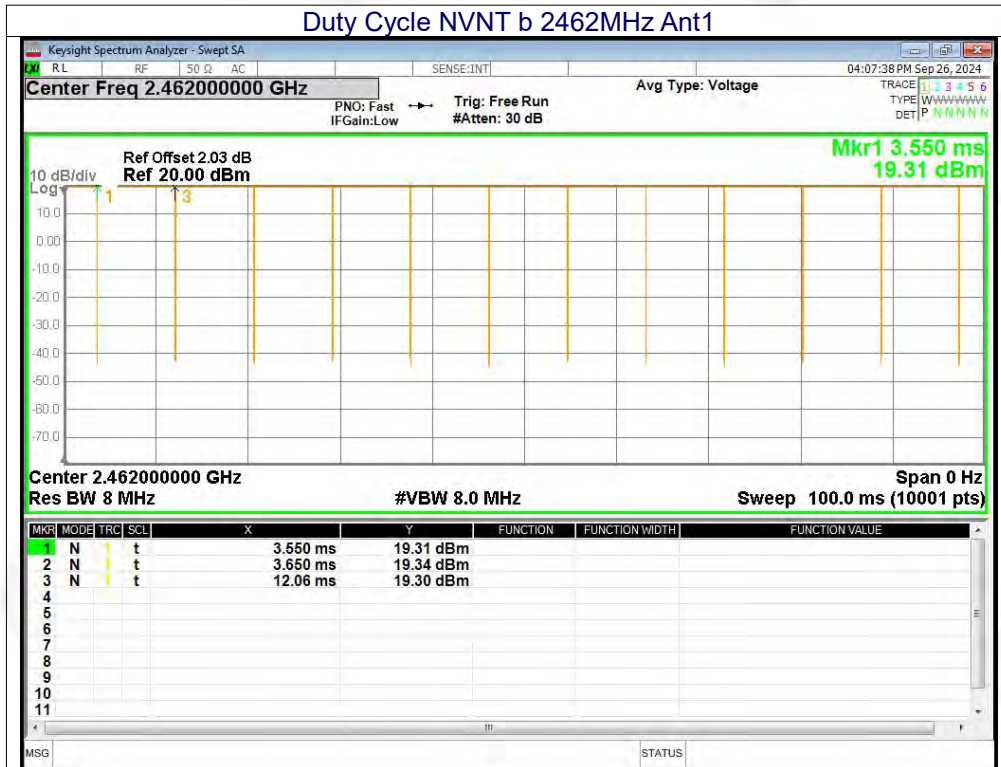

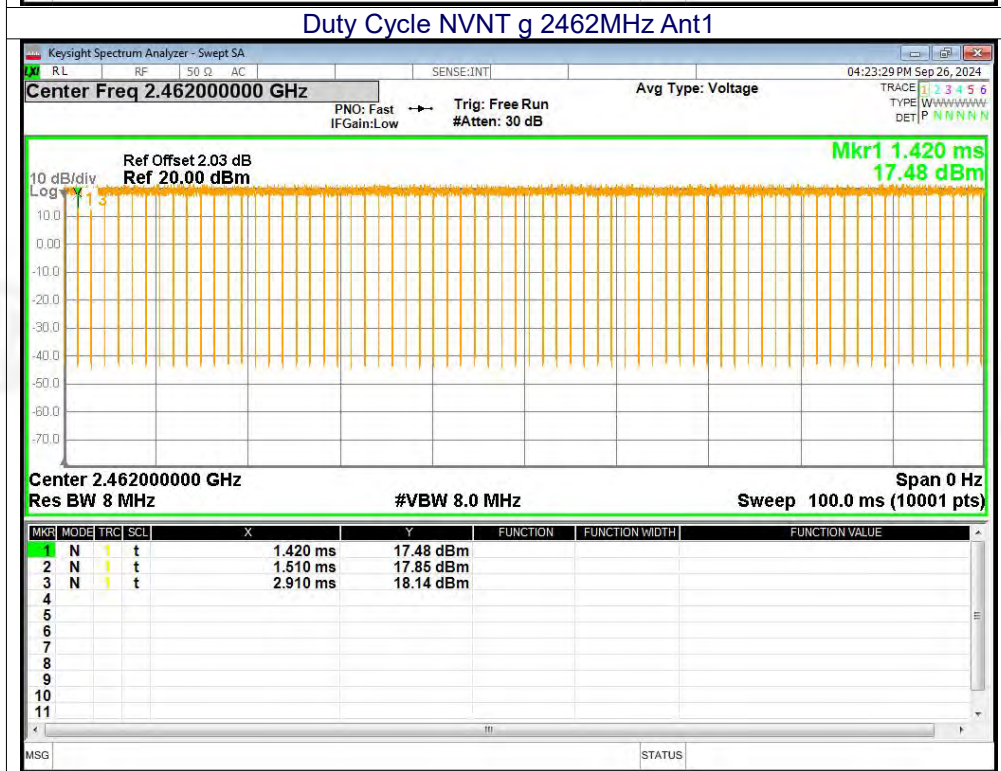
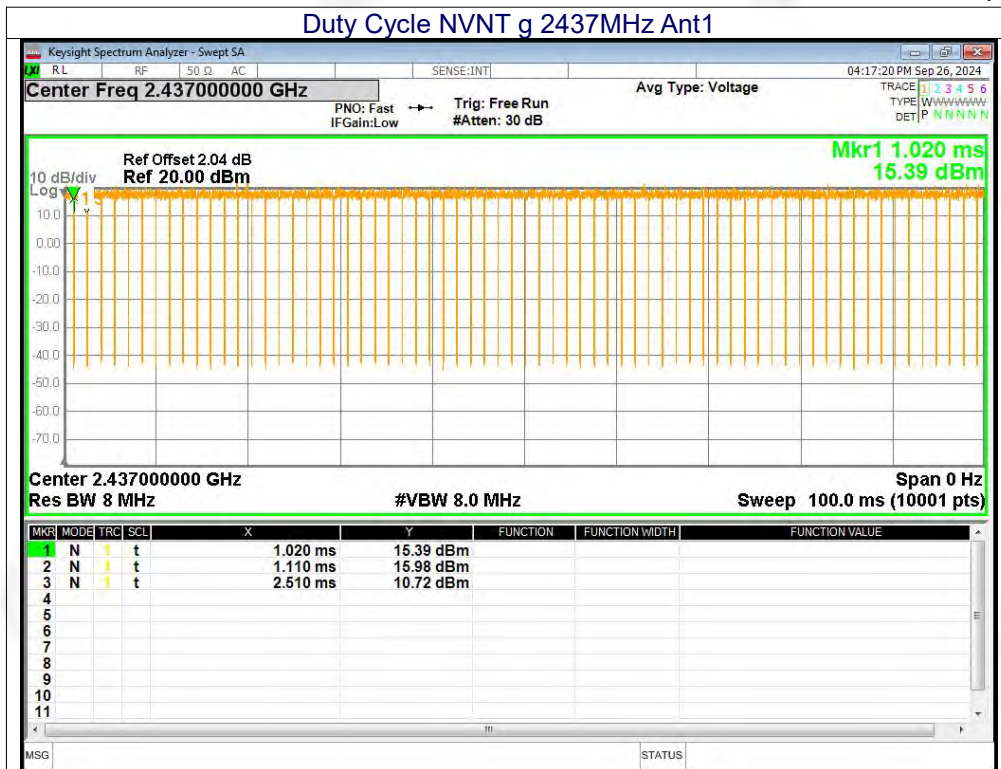

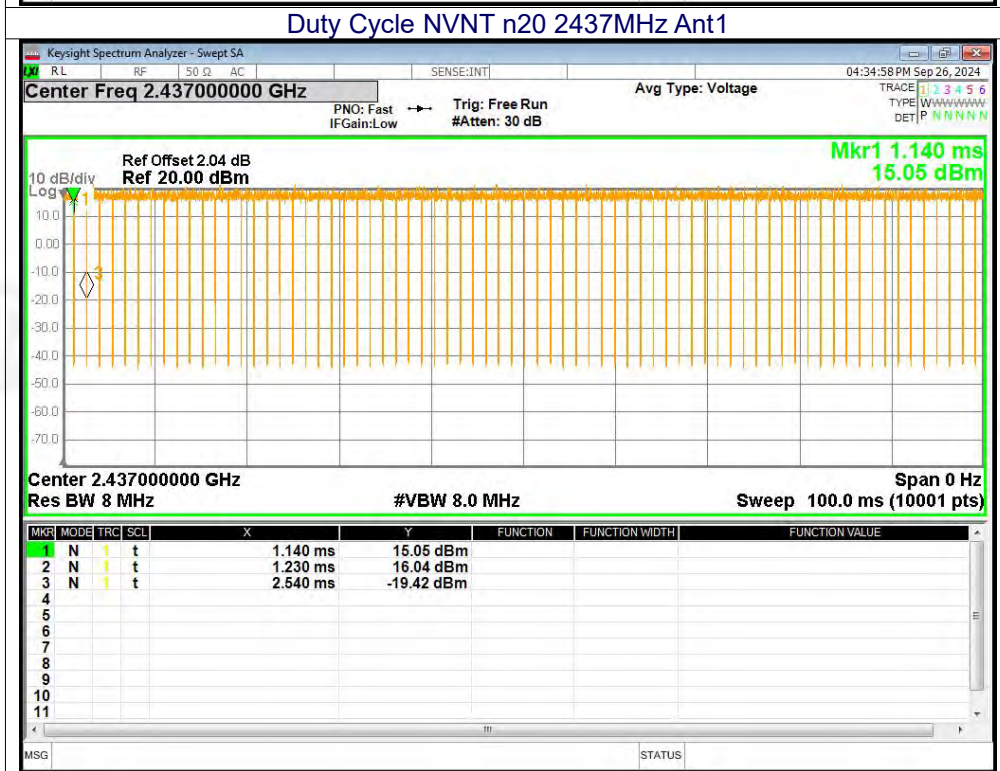
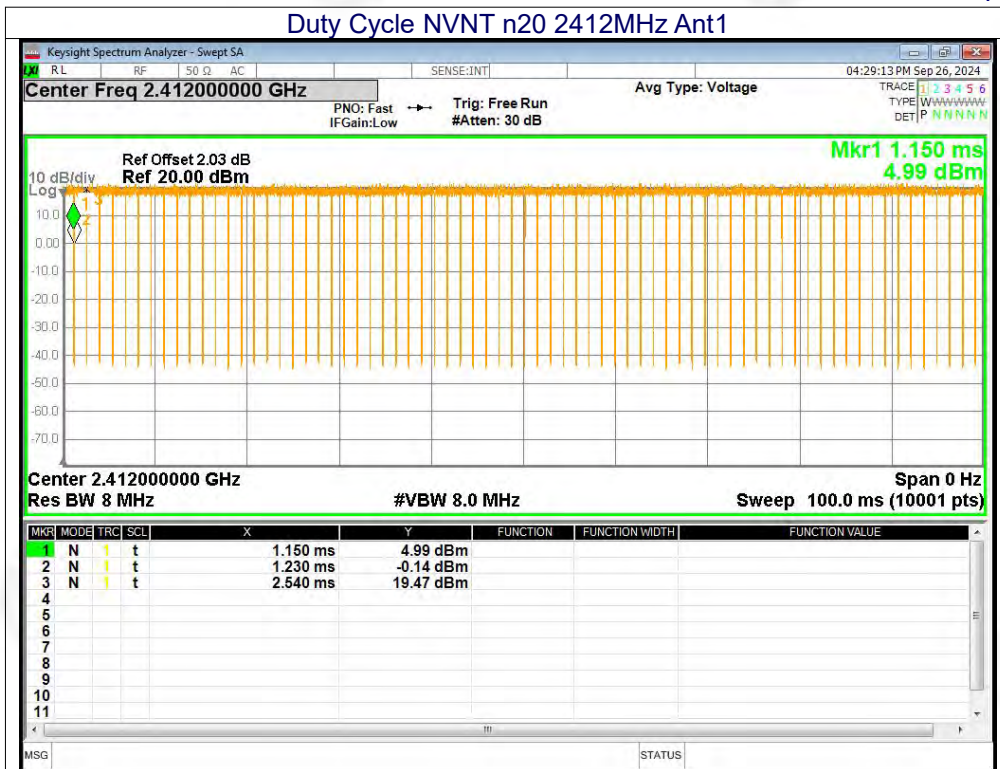

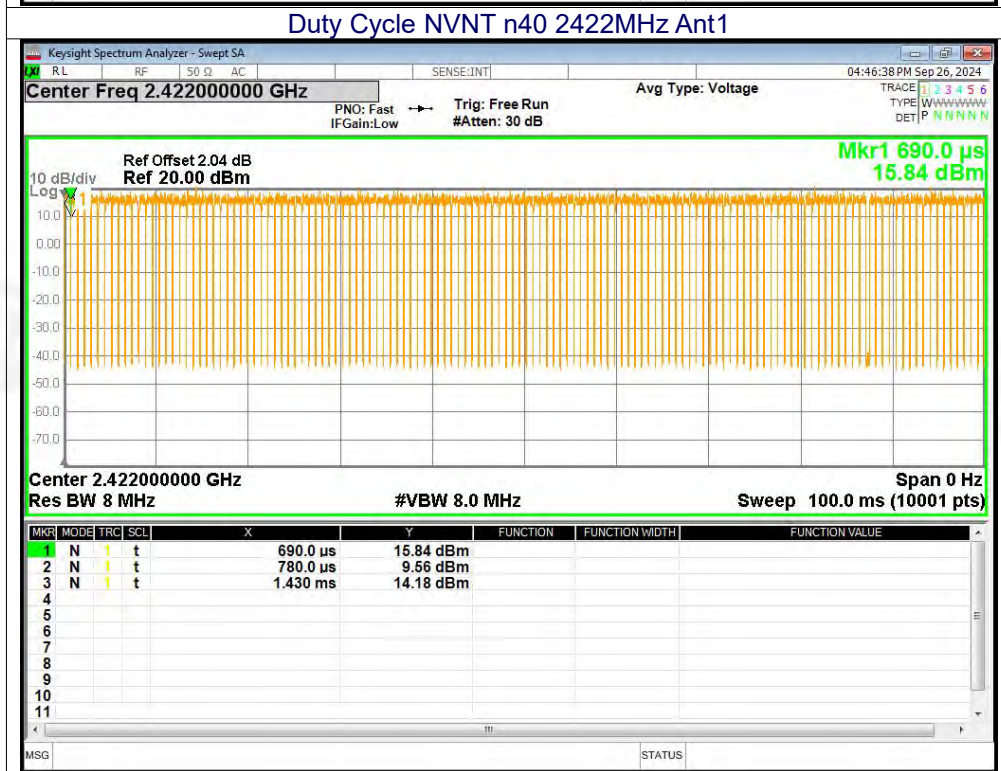
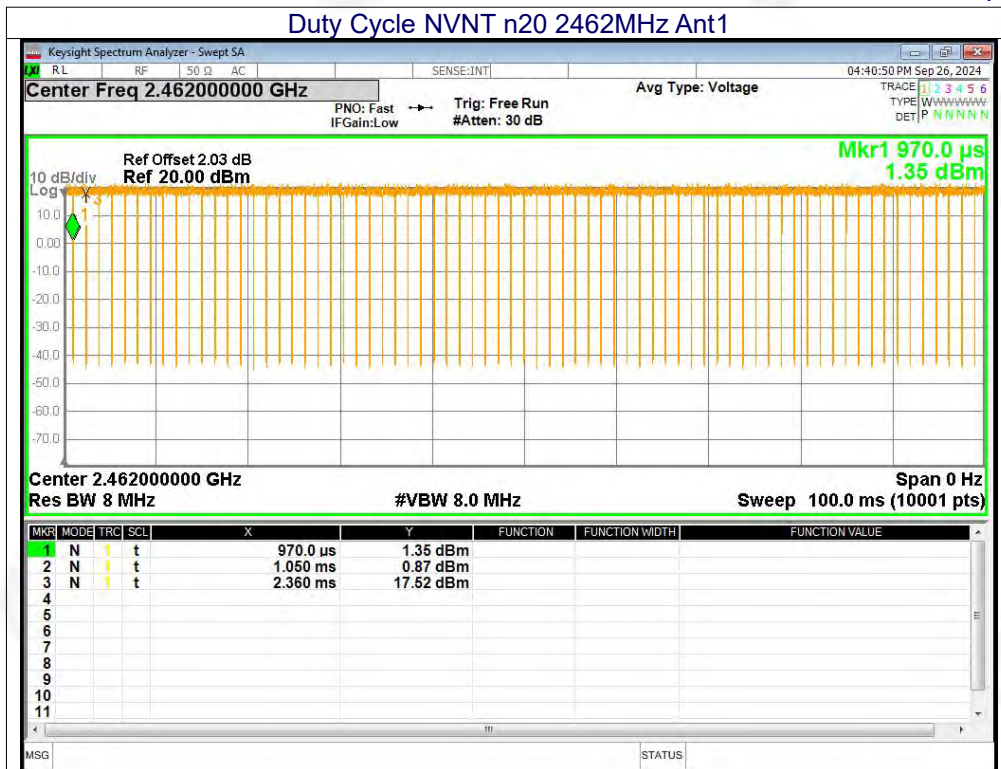

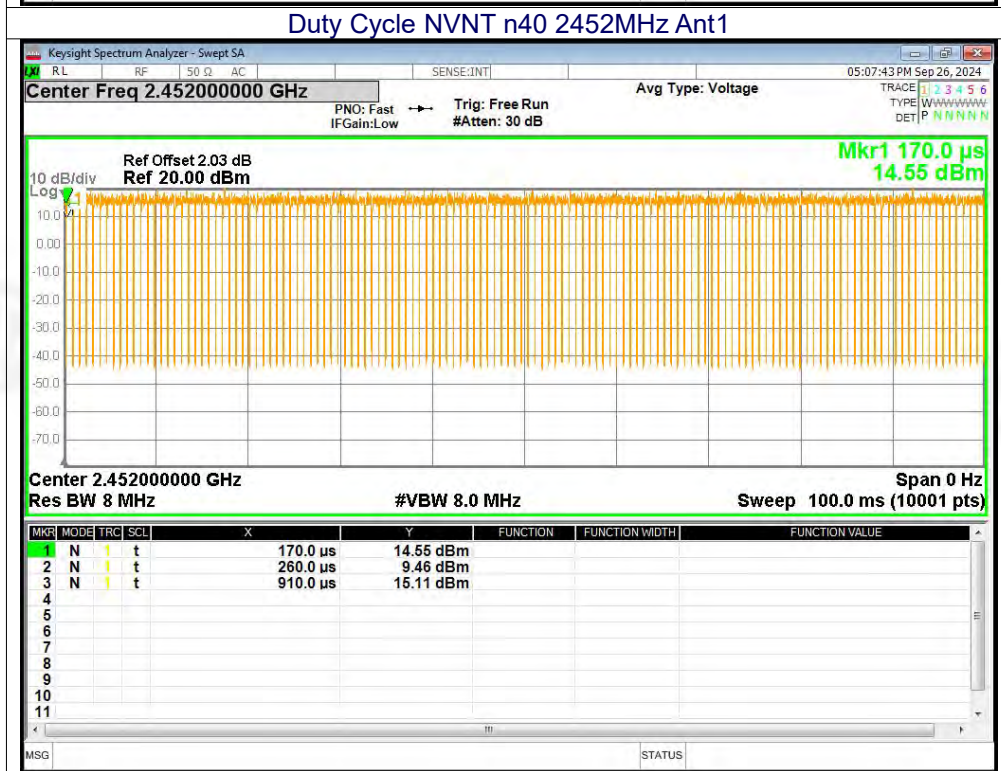
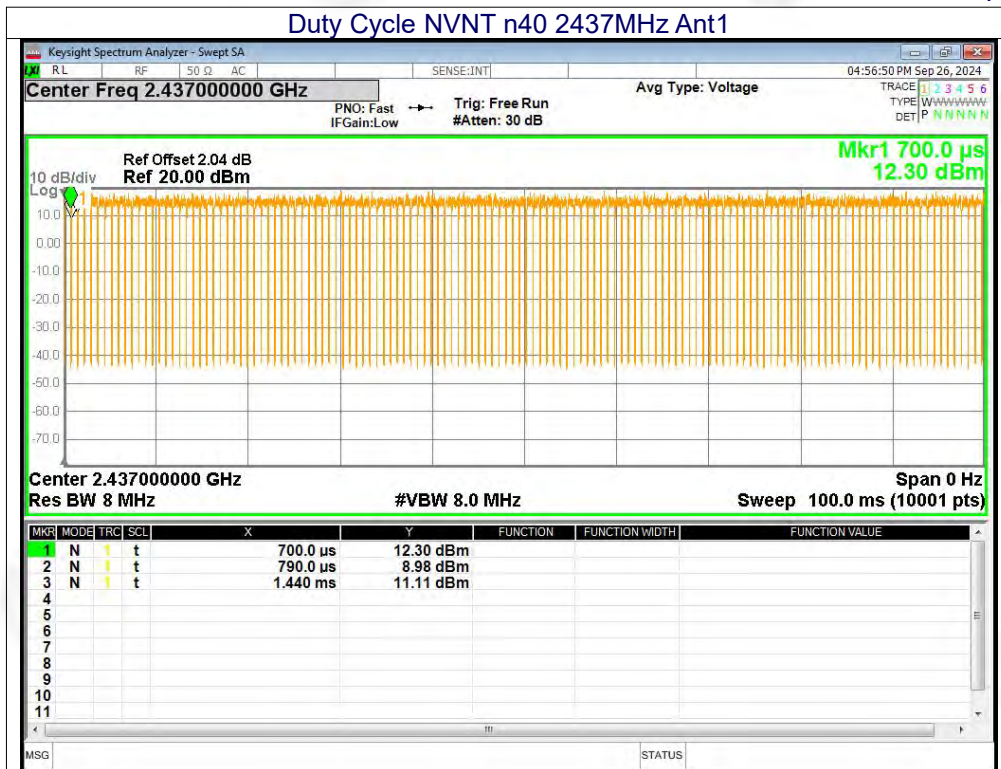



## 11.2 MAXIMUM CONDUCTED OUTPUT POWER

Mode	Frequency (MHz)	Total Power (dBm)	Limit (dBm)	Verdict
b	2412	17.79	30	Pass
b	2437	16.26	30	Pass
b	2462	17.68	30	Pass
g	2412	19.94	30	Pass
g	2437	18.55	30	Pass
g	2462	20.05	30	Pass
n20	2412	19.93	30	Pass
n20	2437	18.51	30	Pass
n20	2462	20.02	30	Pass
n40	2422	18.61	30	Pass
n40	2437	18.54	30	Pass
n40	2452	20.17	30	Pass





## 11.3 -6DB BANDWIDTH

Mode	Frequency (MHz)	-6 dB Bandwidth (MHz)	Limit -6 dB Bandwidth (MHz)	Verdict
b	2412	8.614	0.5	Pass
b	2437	9.558	0.5	Pass
b	2462	8.558	0.5	Pass
g	2412	15.617	0.5	Pass
g	2437	16.177	0.5	Pass
g	2462	15.688	0.5	Pass
n20	2412	16.261	0.5	Pass
n20	2437	17.151	0.5	Pass
n20	2462	16.418	0.5	Pass
n40	2422	32.568	0.5	Pass
n40	2437	35.308	0.5	Pass
n40	2452	35.893	0.5	Pass

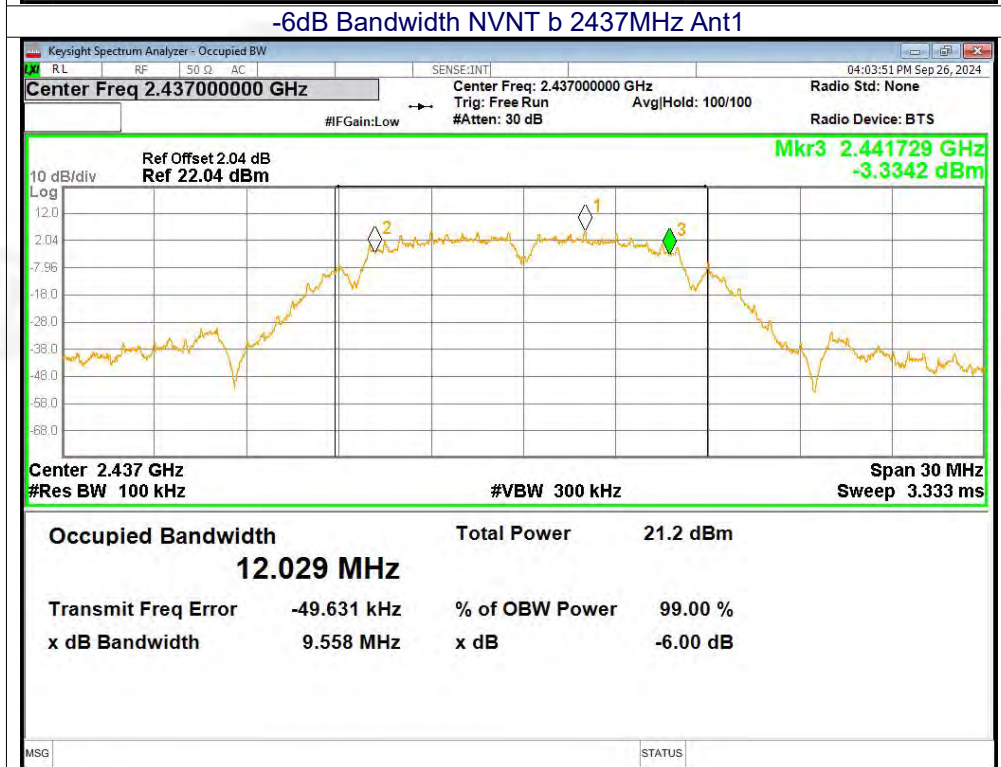
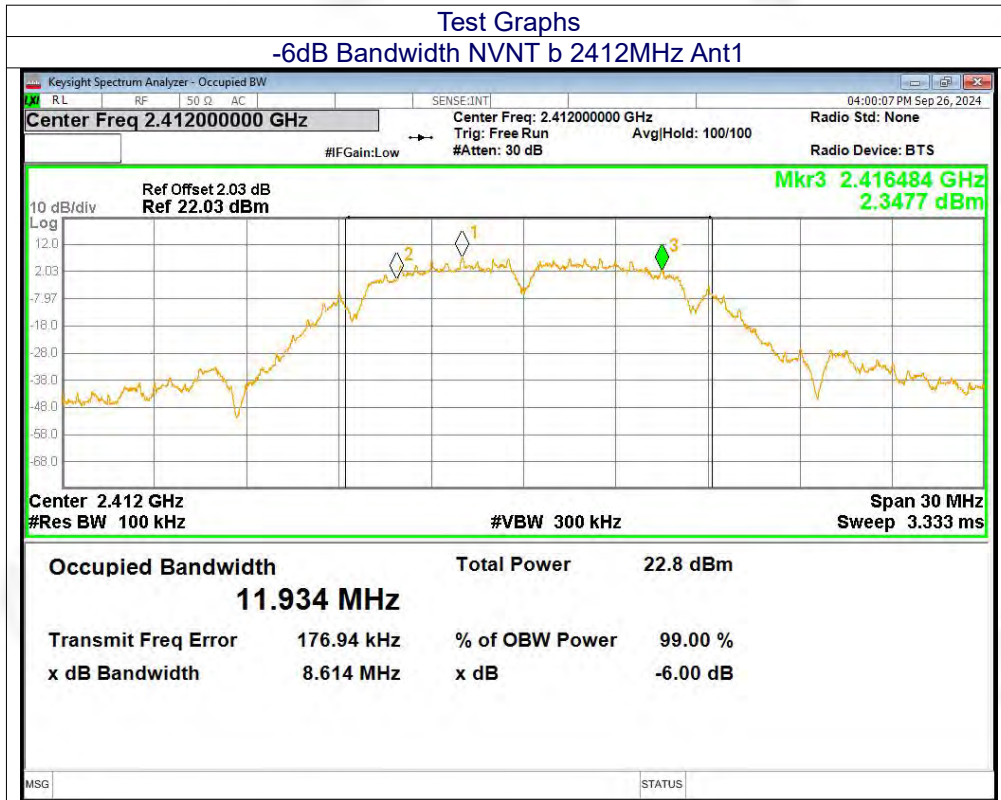

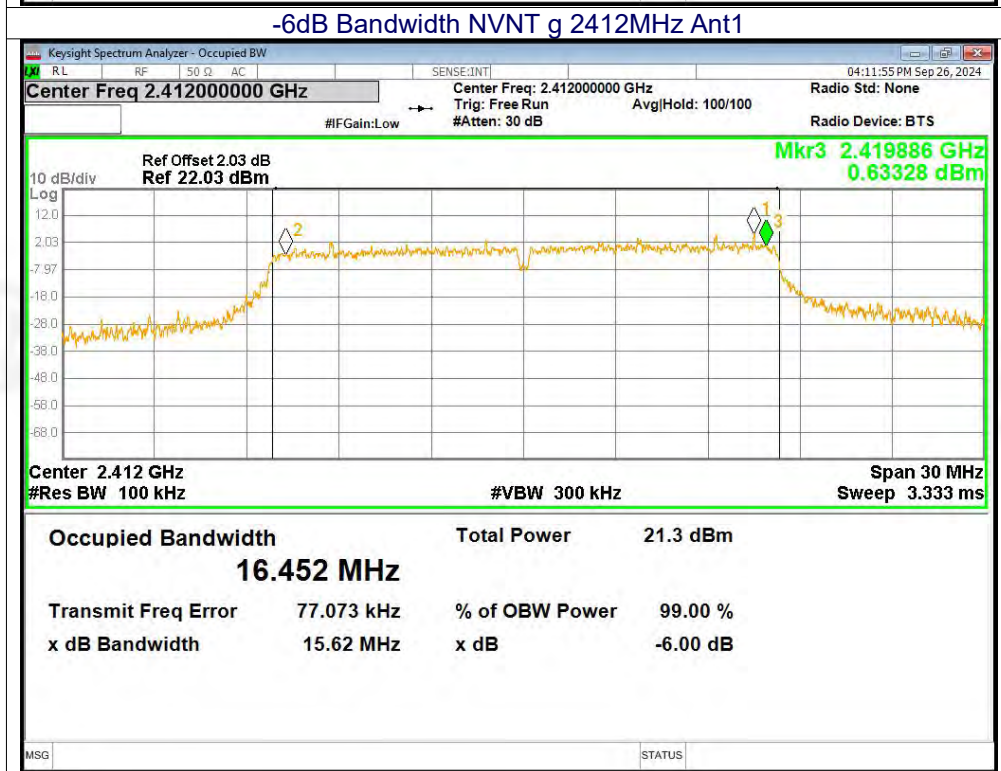
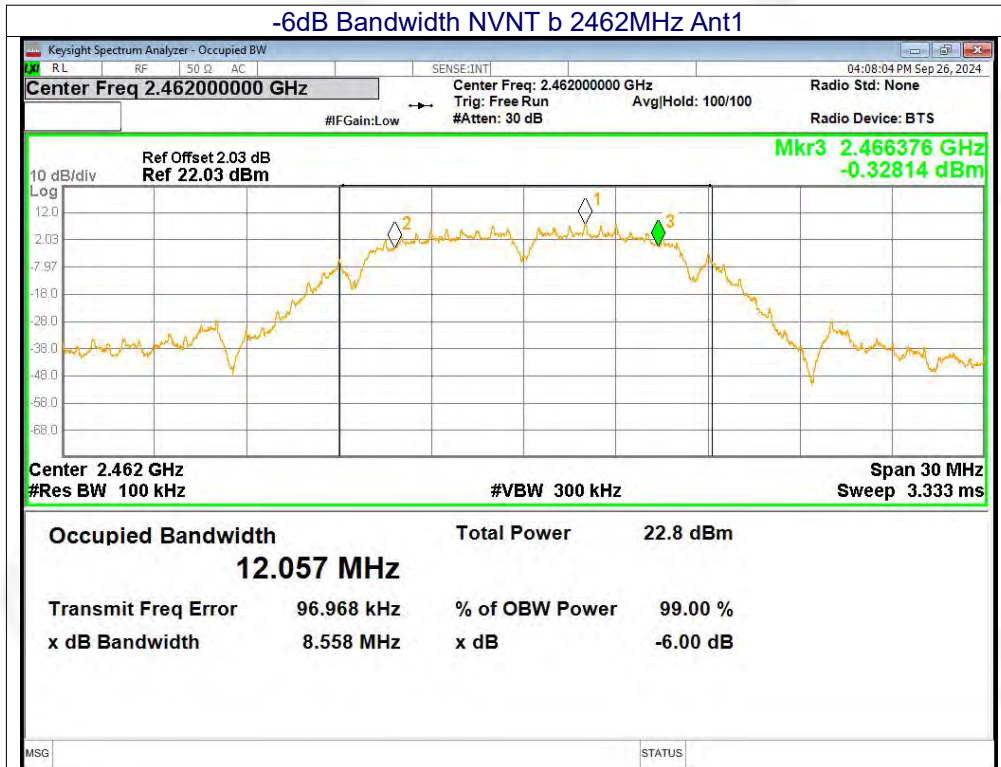

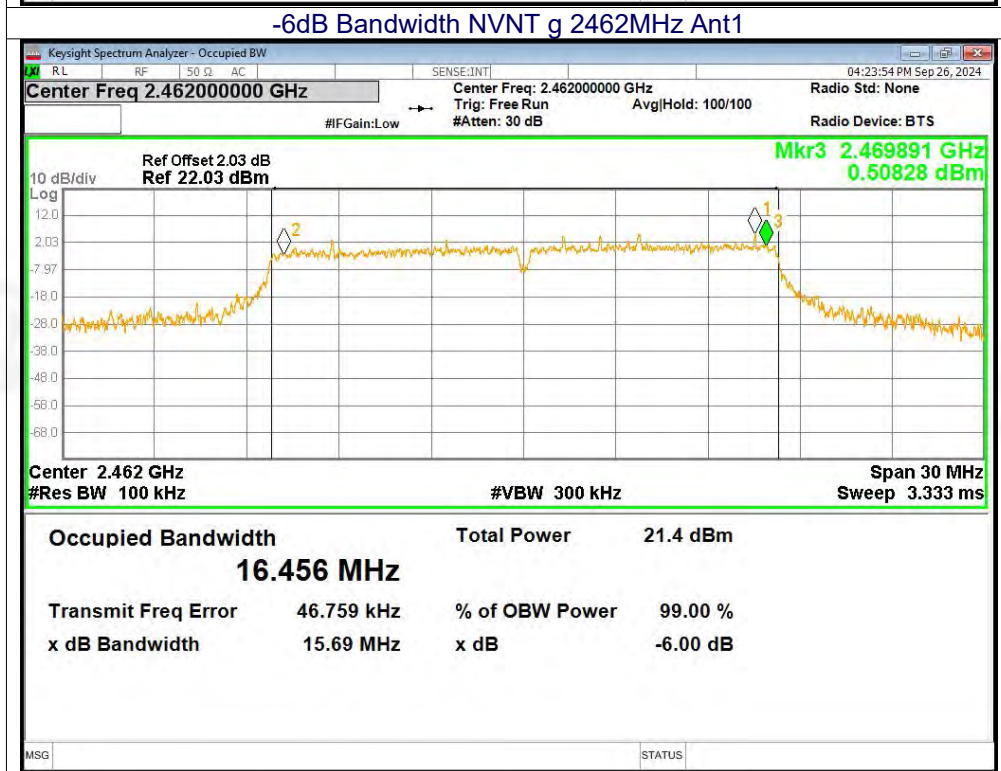
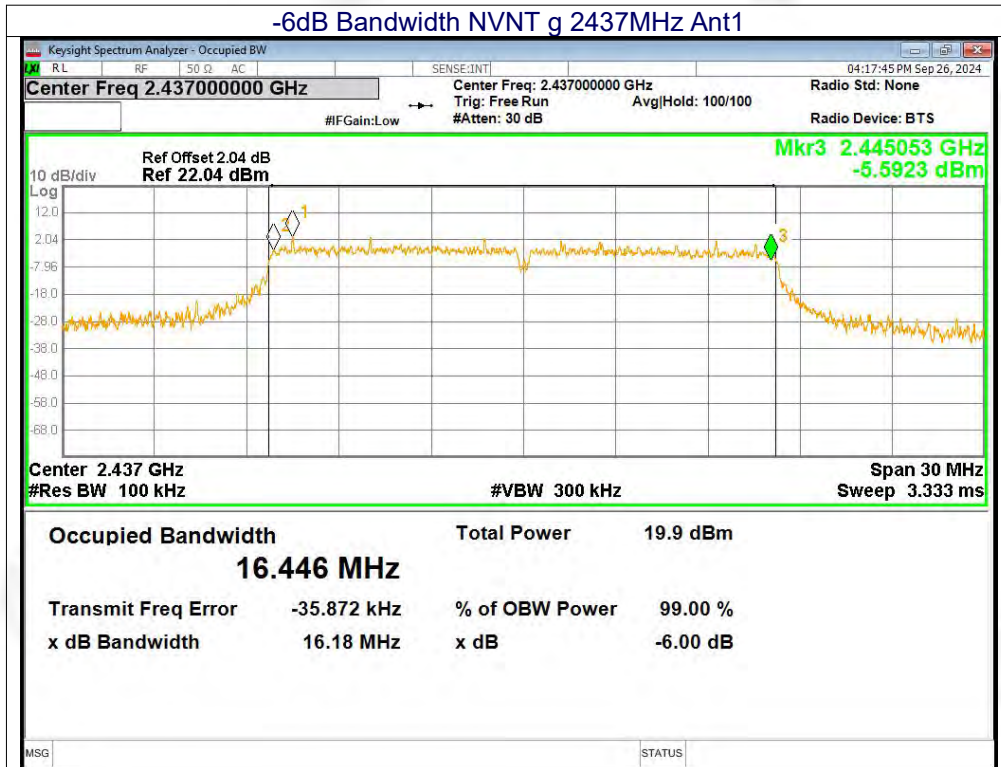

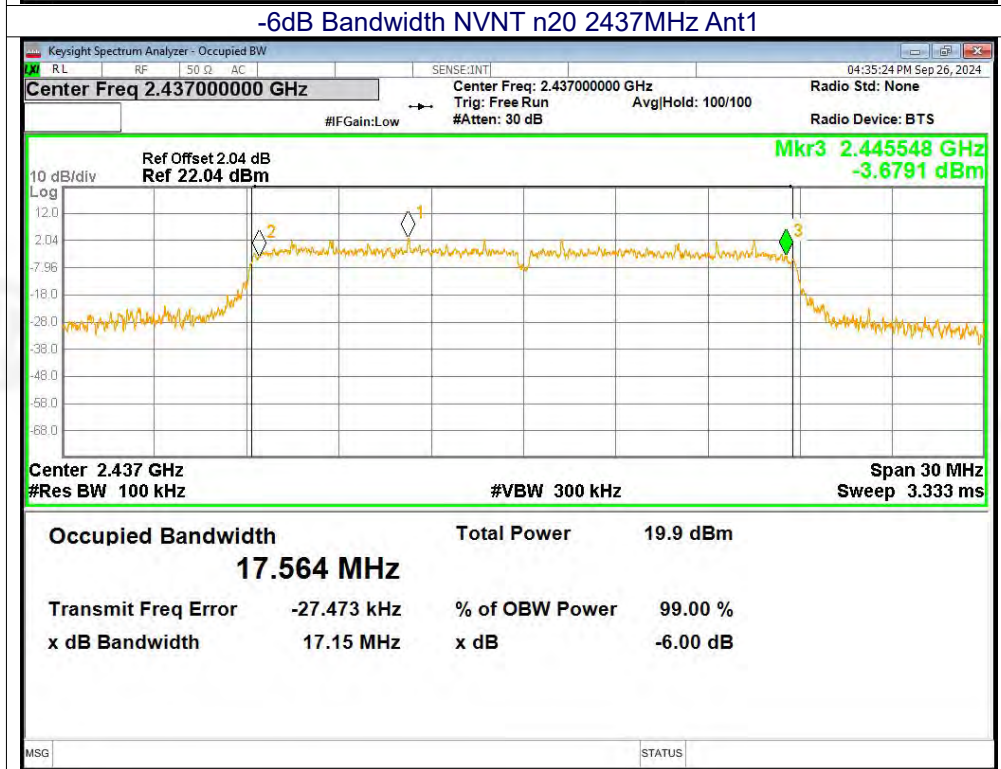
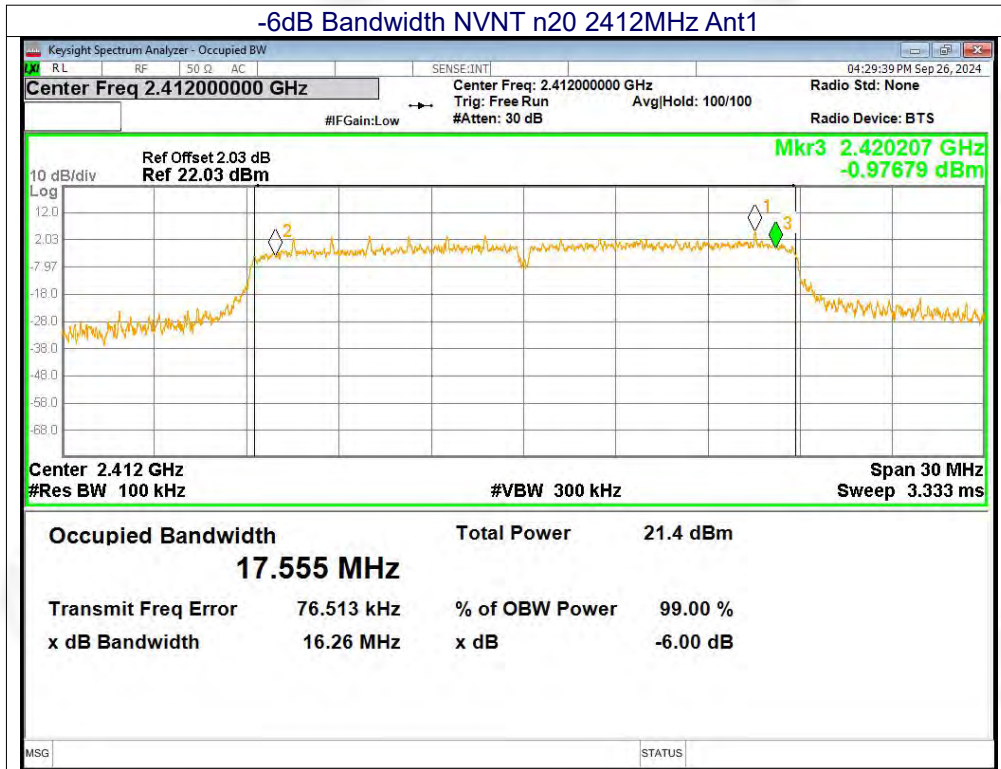

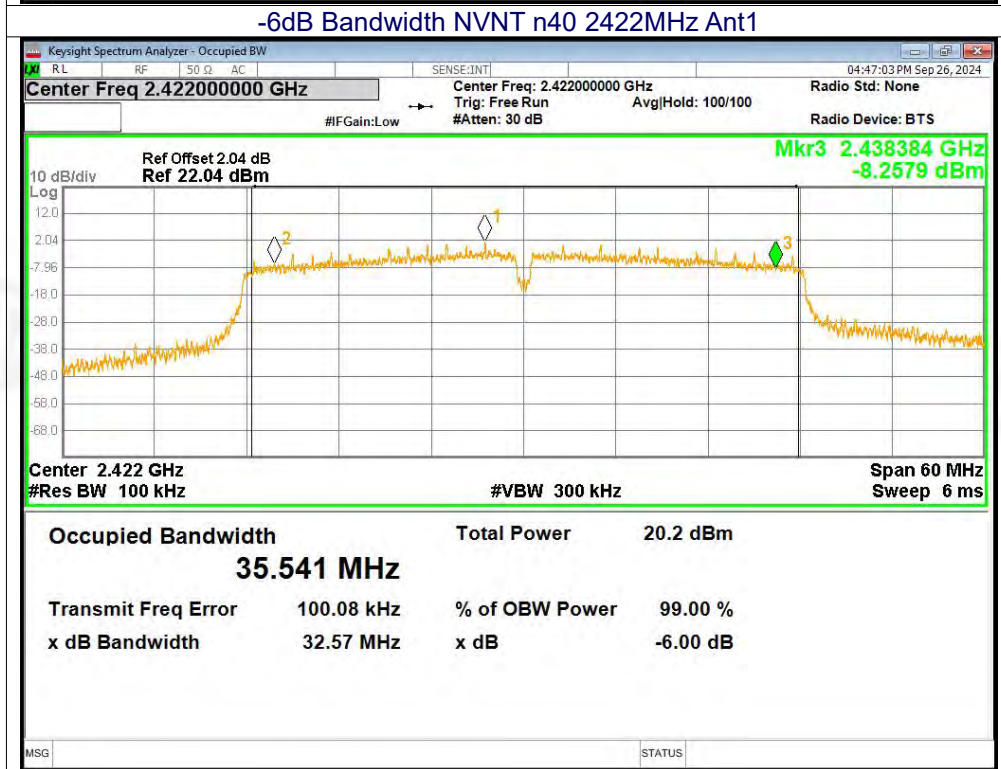
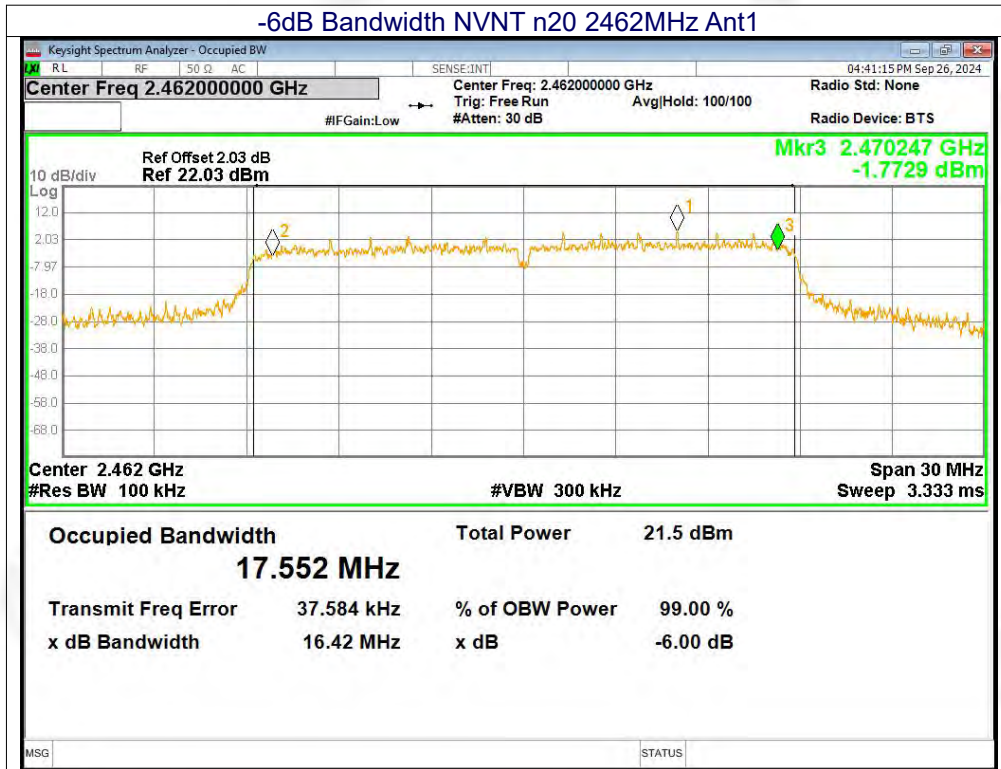

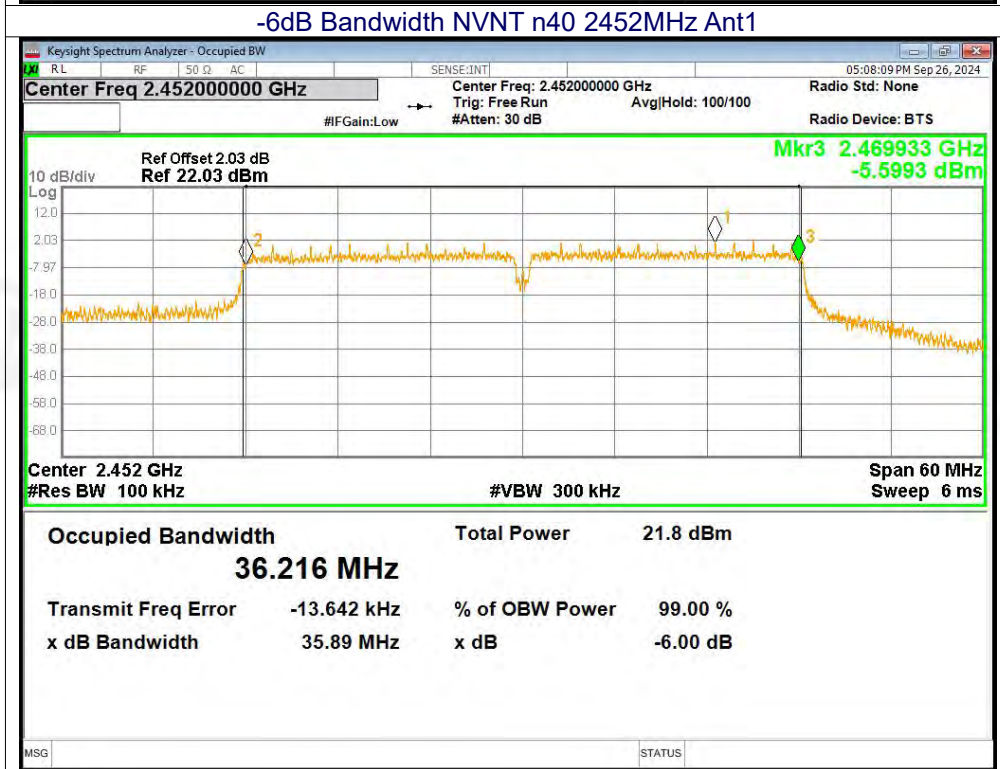
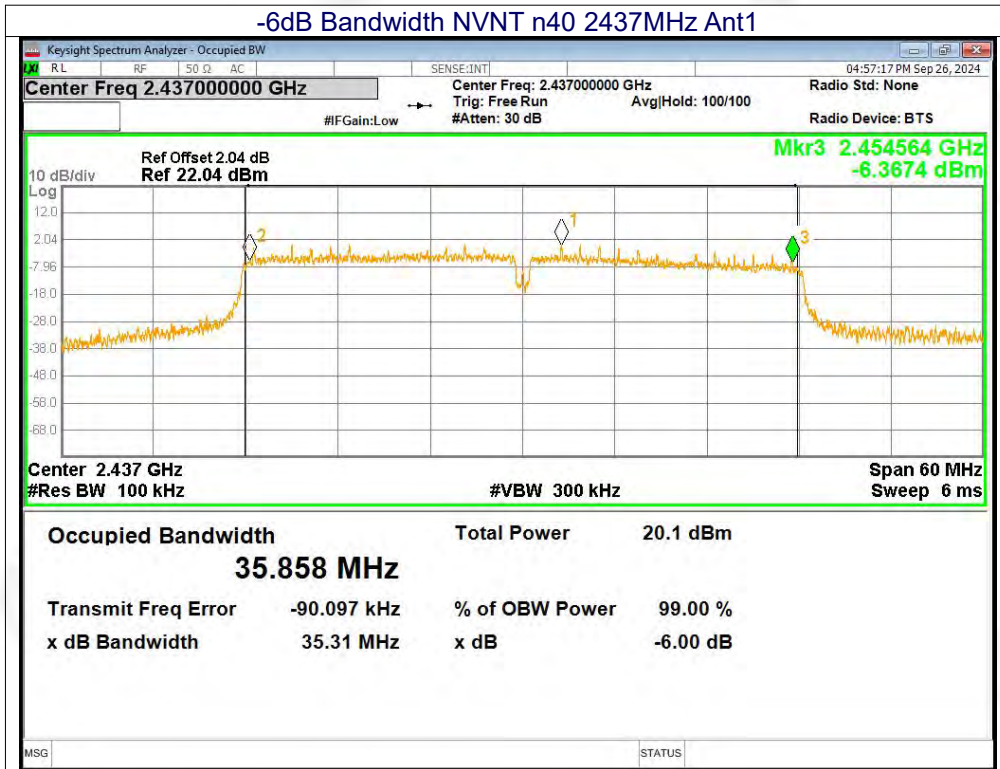



#### 11.4 OCCUPIED CHANNEL BANDWIDTH

Mode	Frequency (MHz)	99% OBW (MHz)
b	2412	11.86
b	2437	11.993
b	2462	12.036
g	2412	16.593
g	2437	16.541
g	2462	16.569
n20	2412	17.577
n20	2437	17.609
n20	2462	17.597
n40	2422	35.617
n40	2437	35.933
n40	2452	36.316



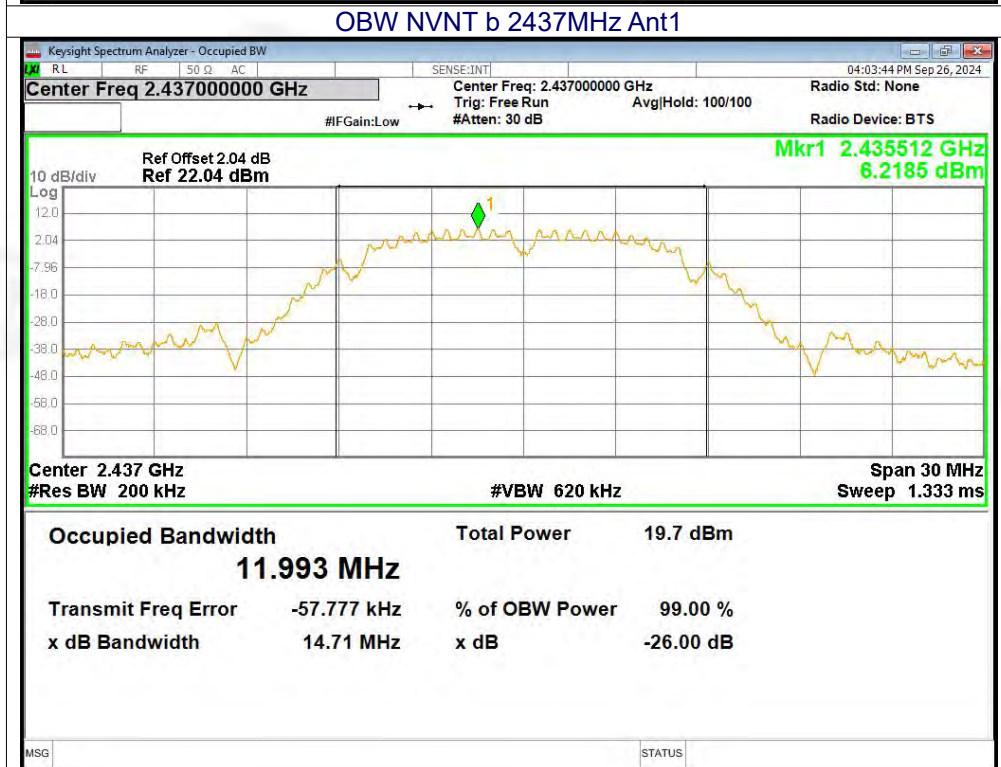
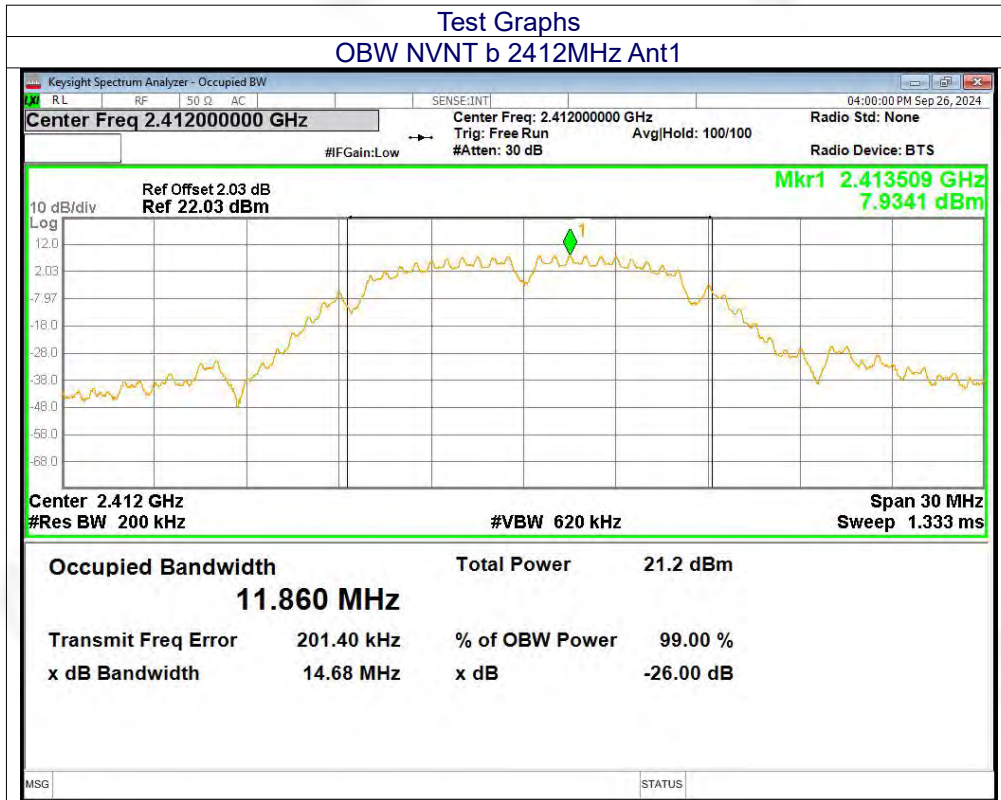

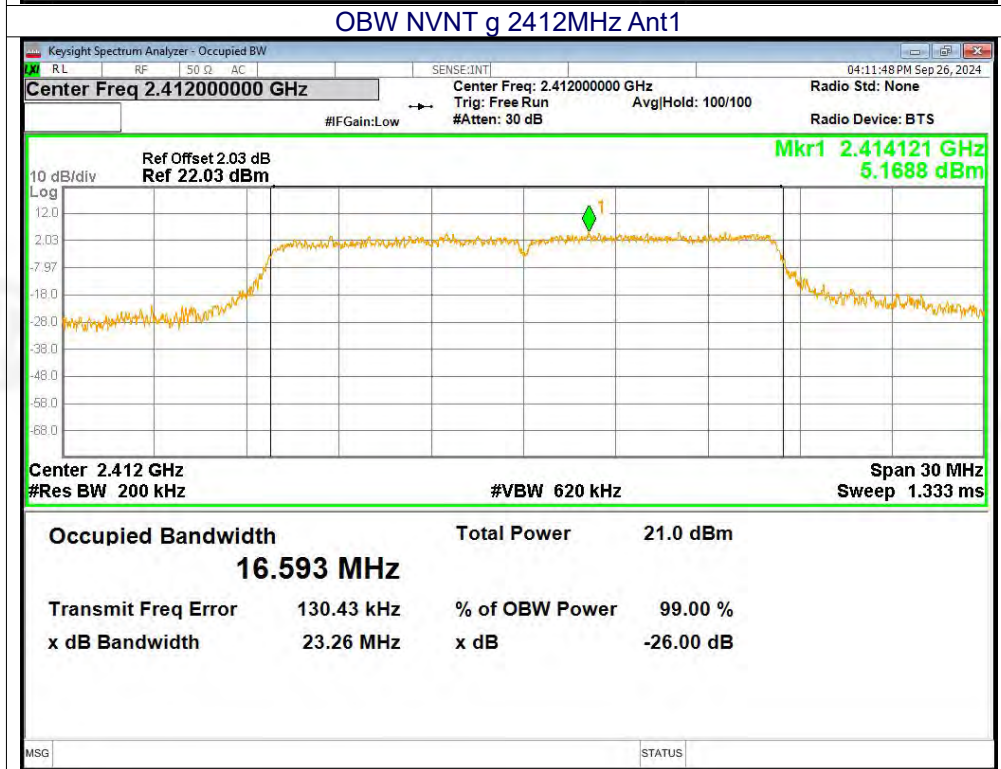
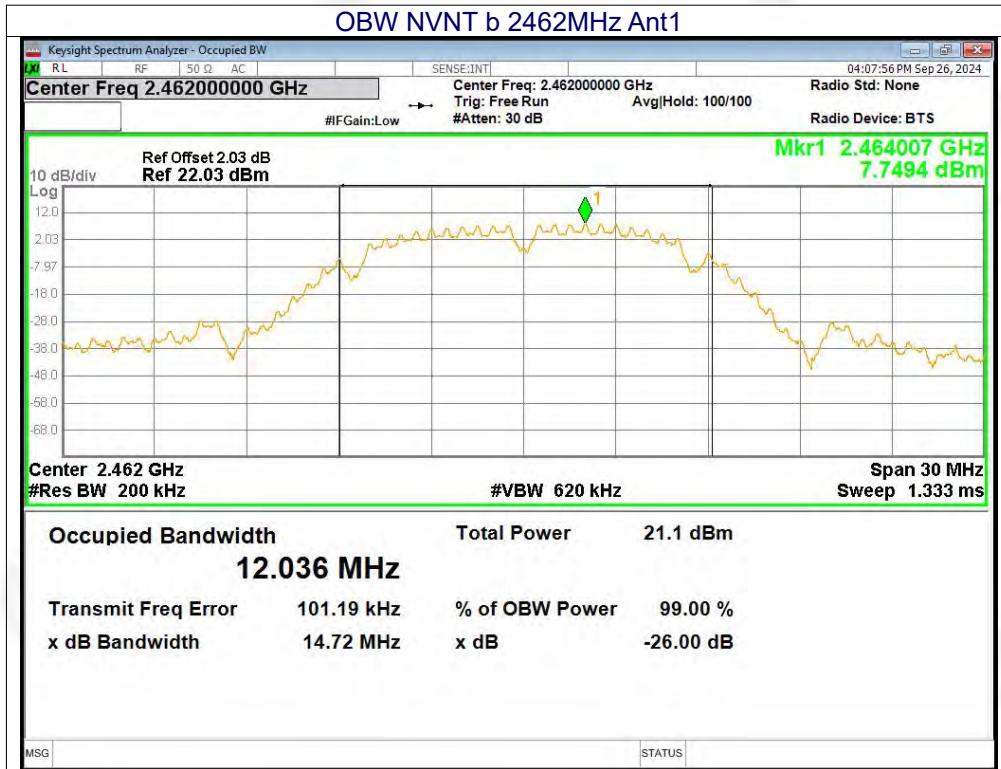

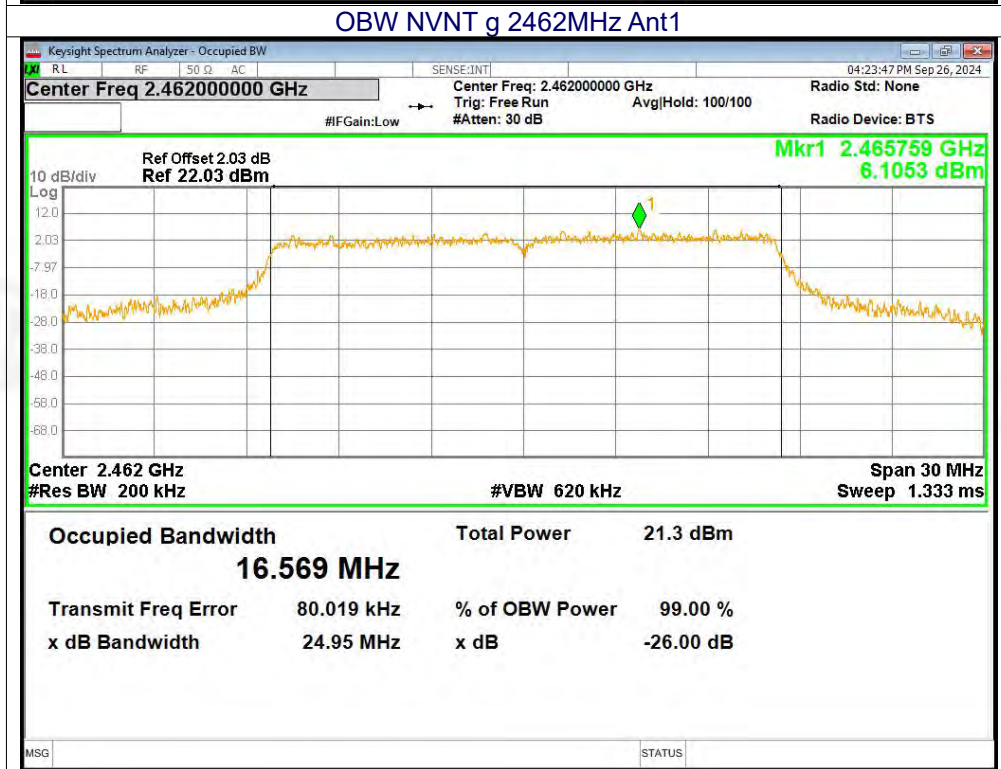
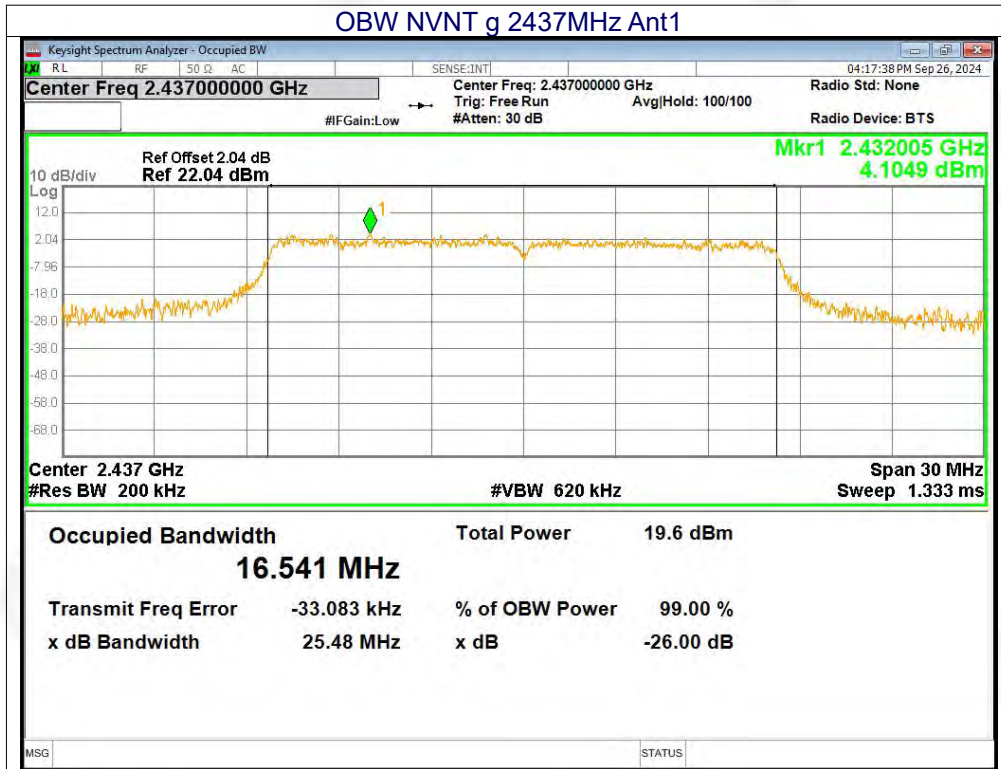



### OBW NVNT n20 2412MHz Ant1

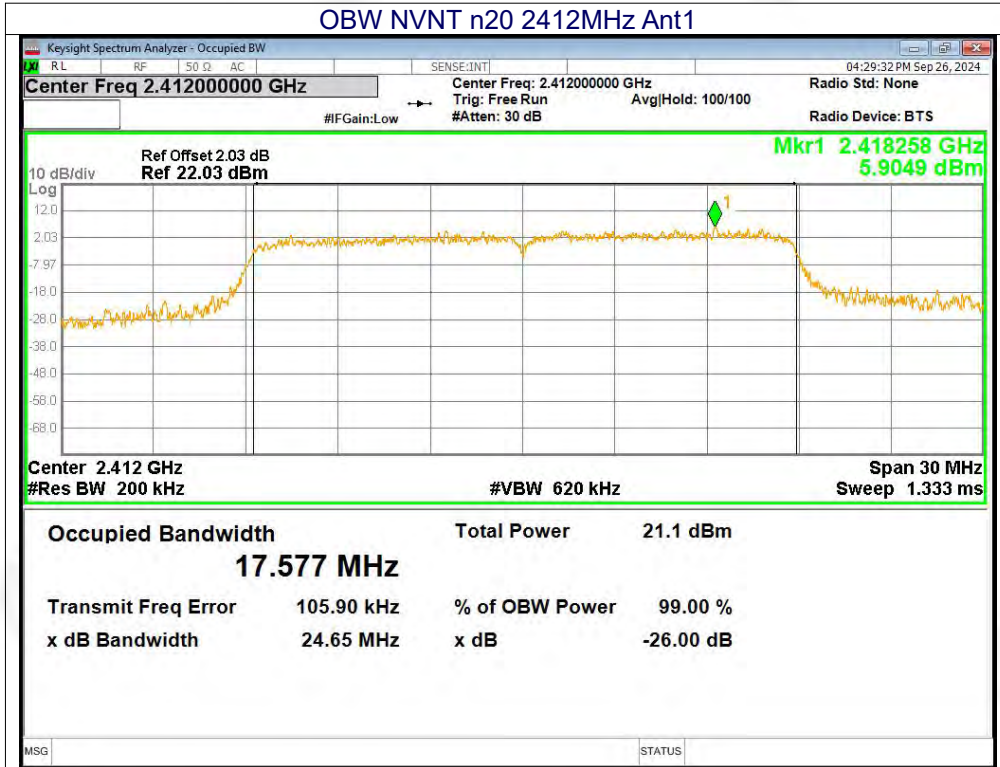

### OBW NVNT n20 2437MHz Ant1

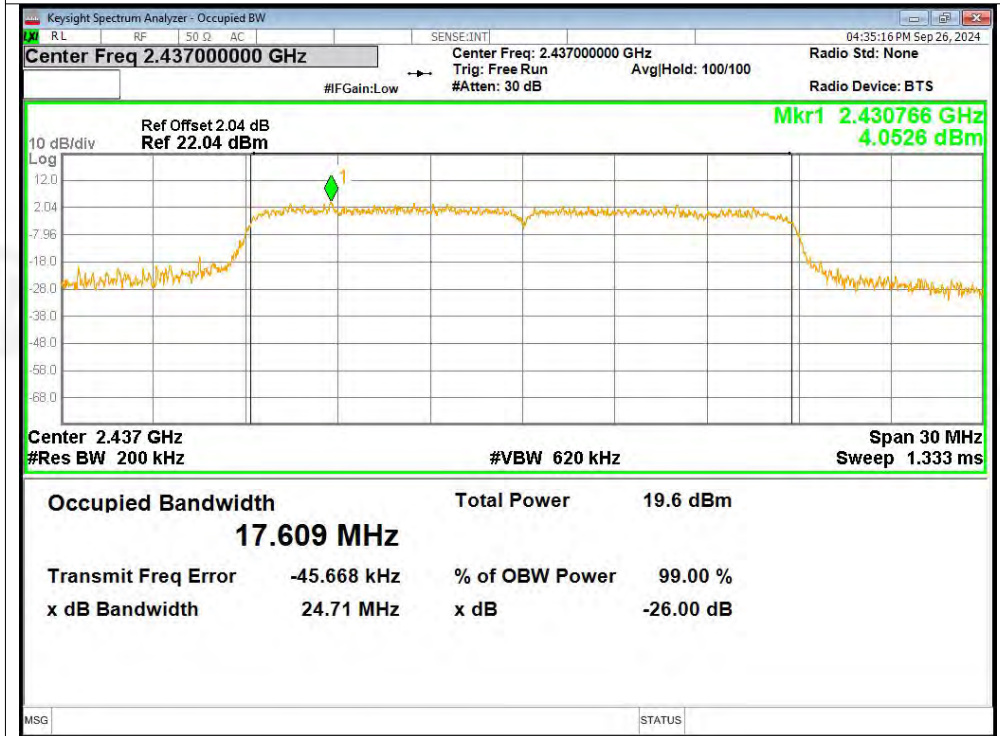



### OBW NVNT n20 2462MHz Ant1

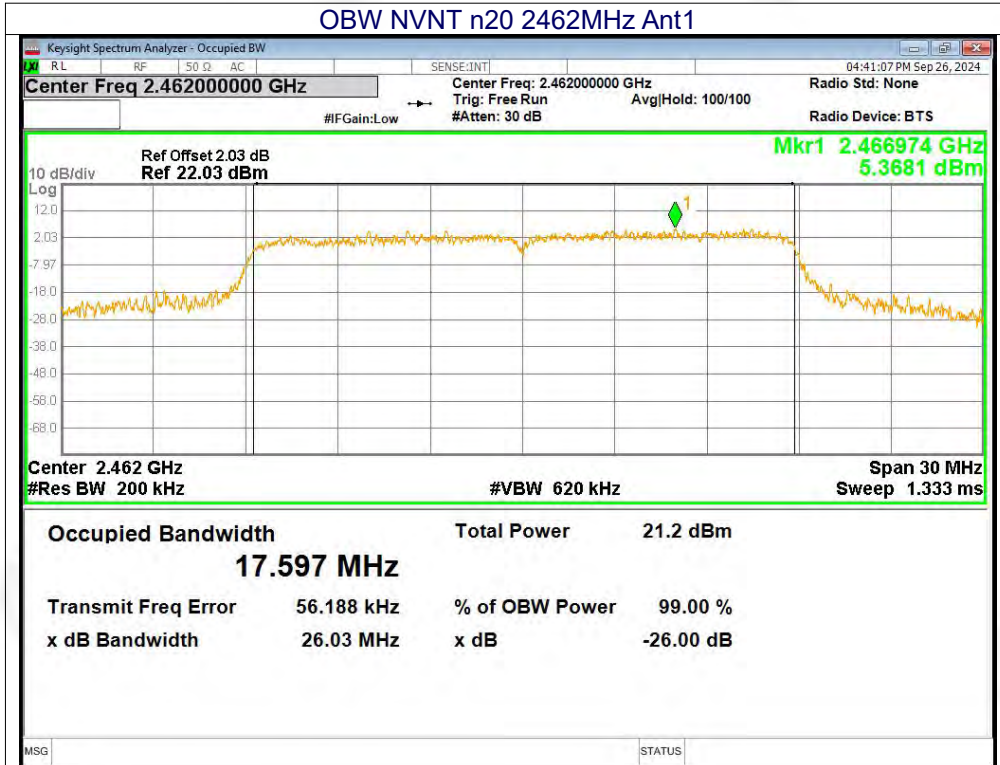

### OBW NVNT n40 2422MHz Ant1

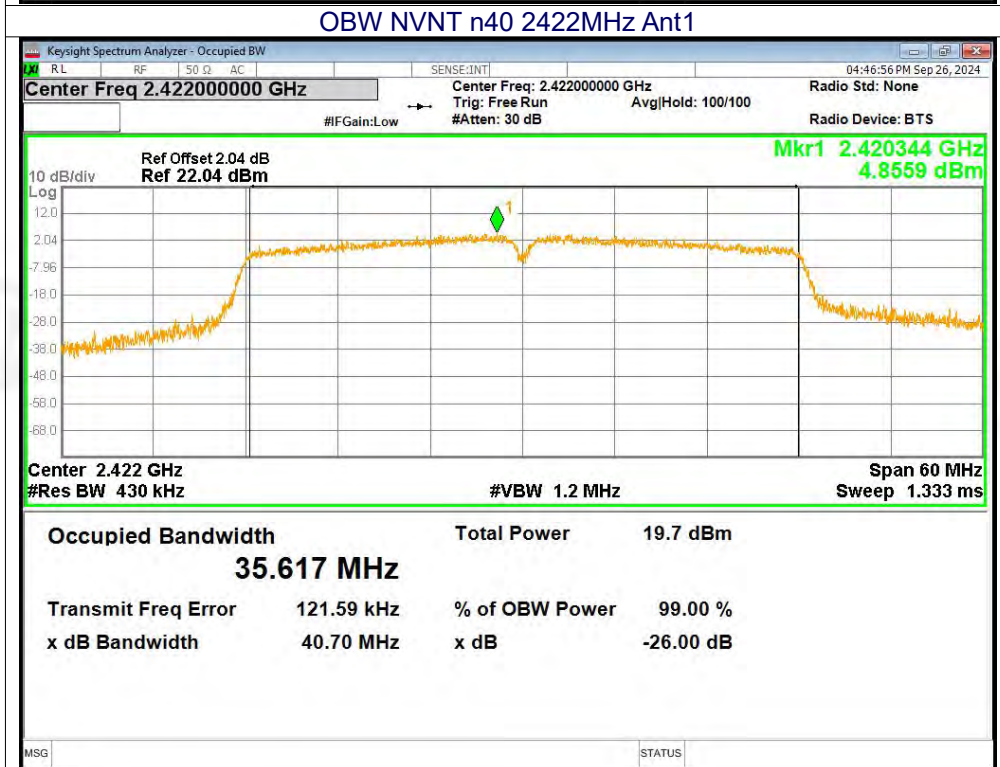



### OBW NVNT n40 2437MHz Ant1

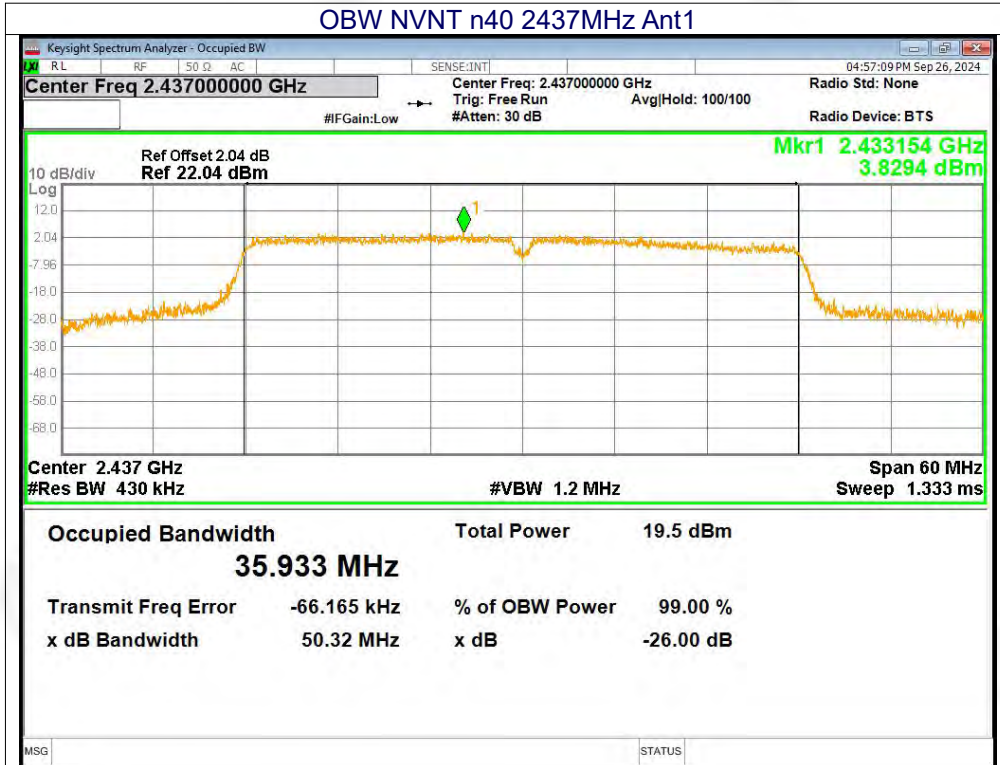

### OBW NVNT n40 2452MHz Ant1

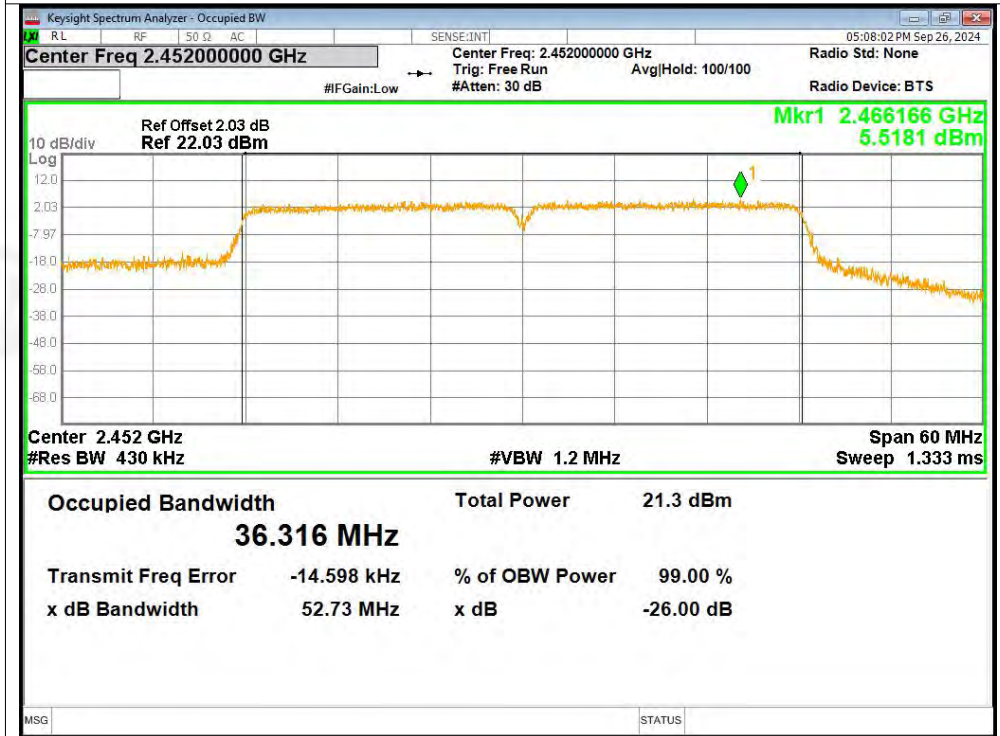



## 11.5 MAXIMUM POWER SPECTRAL DENSITY LEVEL

Mode	Frequency (MHz)	Antenna	Total PSD (dBm/3kHz)	Limit (dBm/3kHz)	Verdict
b	2412	Ant1	-3.16	8	Pass
b	2437	Ant1	-4.83	8	Pass
b	2462	Ant1	-3.51	8	Pass
g	2412	Ant1	-8.65	8	Pass
g	2437	Ant1	-10.84	8	Pass
g	2462	Ant1	-9.39	8	Pass
n20	2412	Ant1	-7.18	8	Pass
n20	2437	Ant1	-10.36	8	Pass
n20	2462	Ant1	-7.4	8	Pass
n40	2422	Ant1	-12.09	8	Pass
n40	2437	Ant1	-13.26	8	Pass
n40	2452	Ant1	-11.85	8	Pass



### Test Graphs

#### PSD NVNT b 2412MHz Ant1



#### PSD NVNT b 2437MHz Ant1

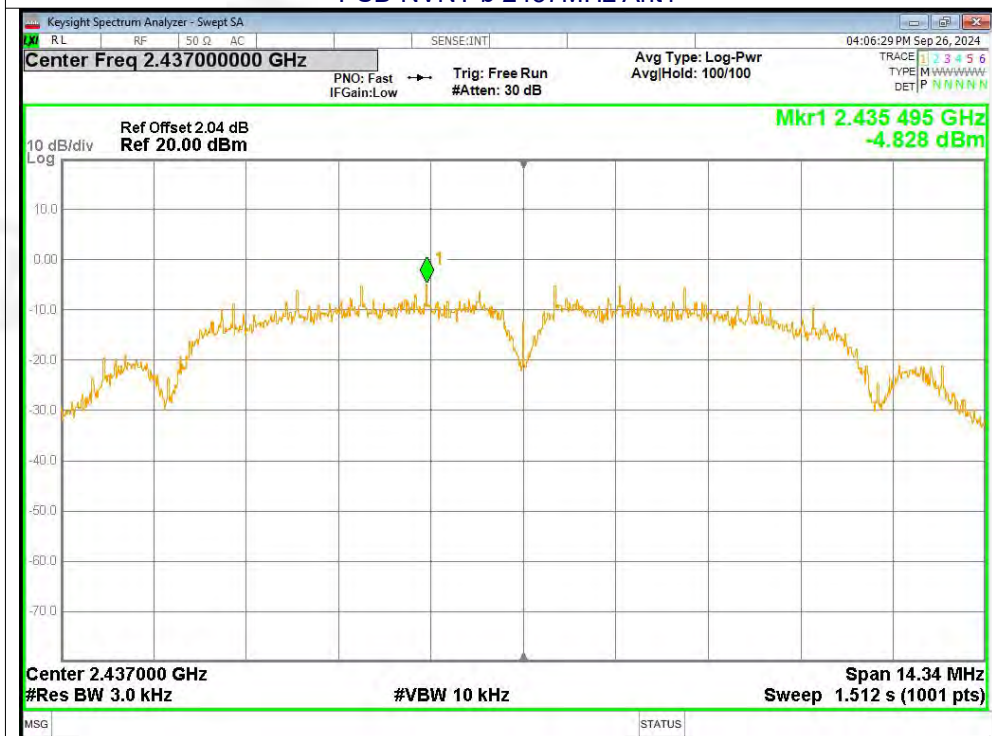



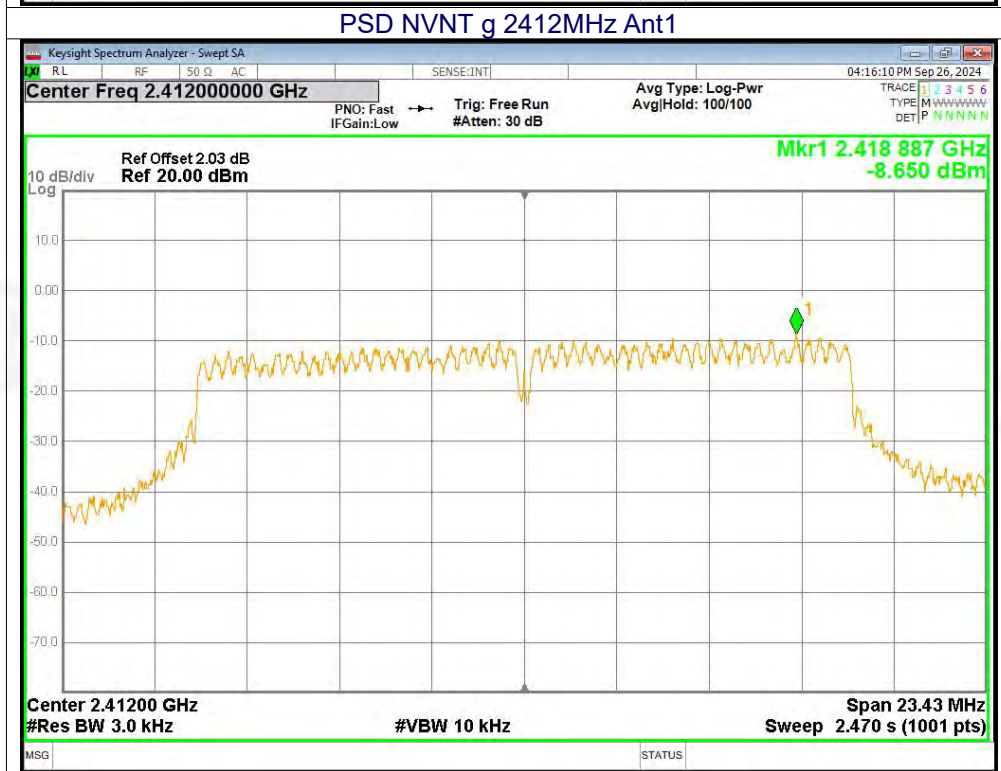
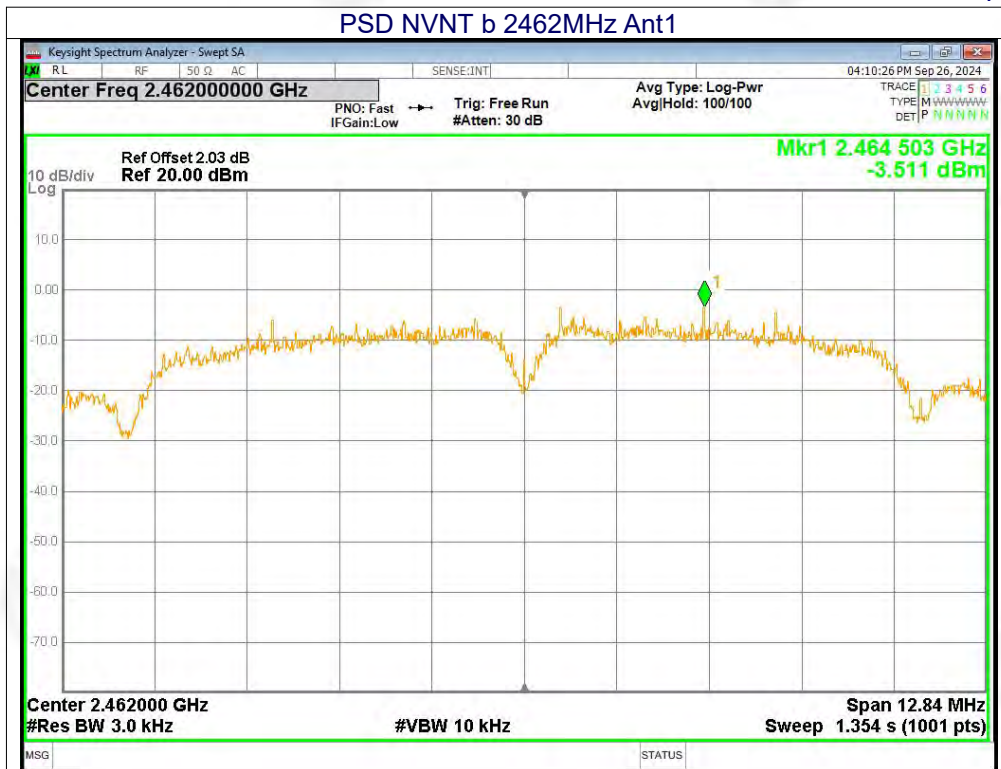

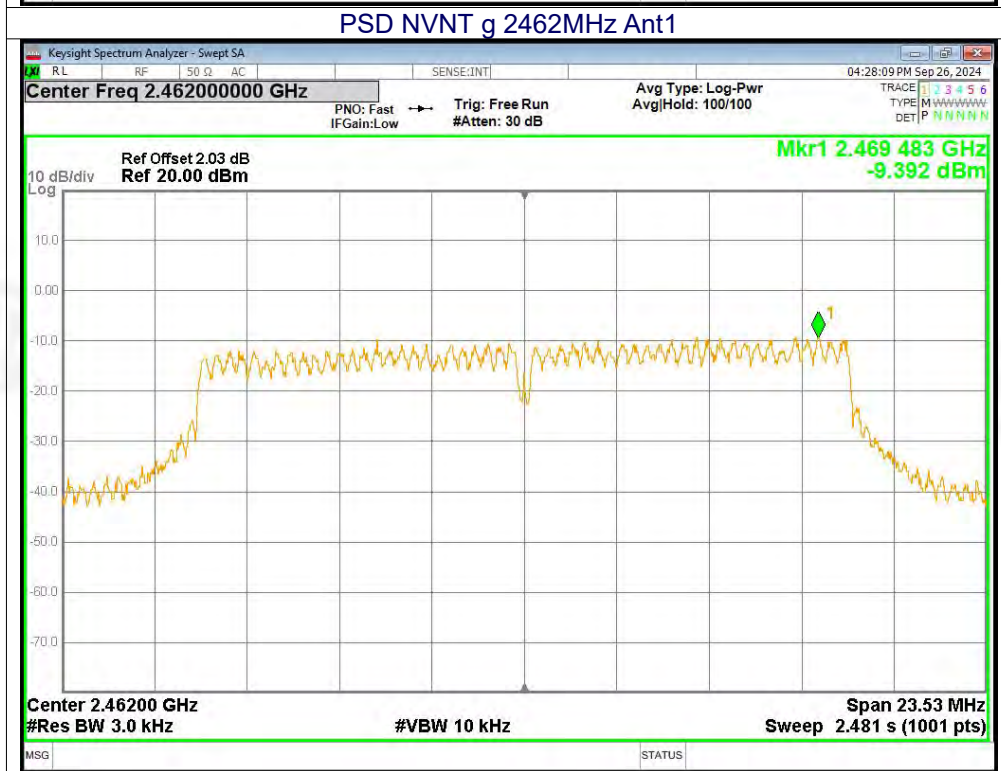
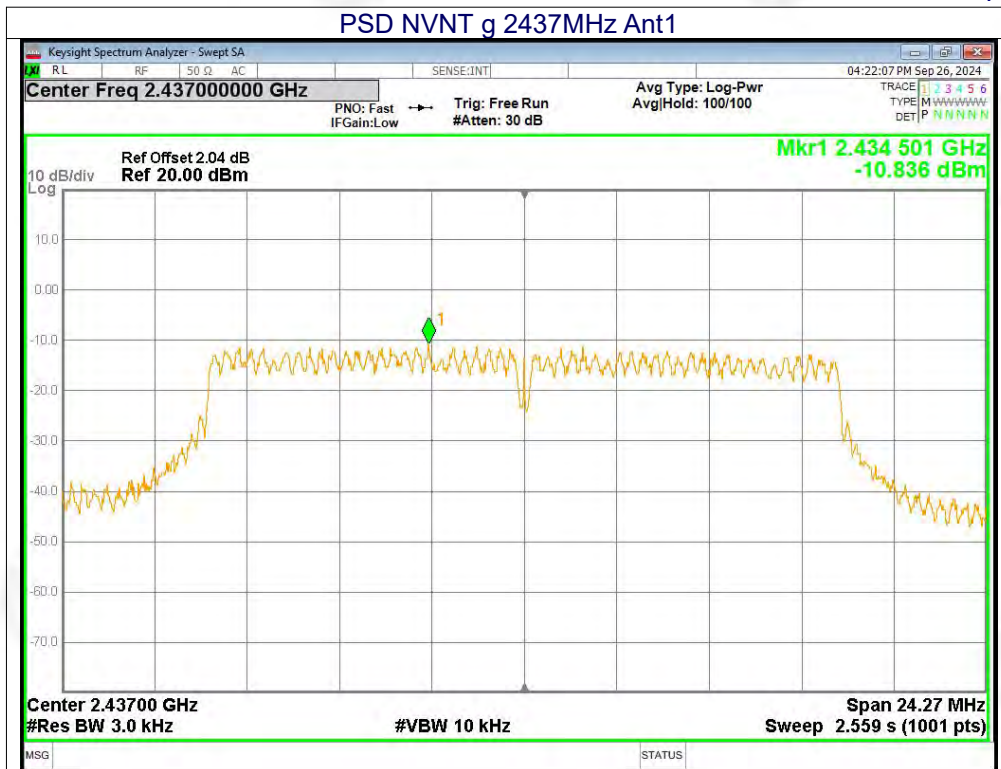

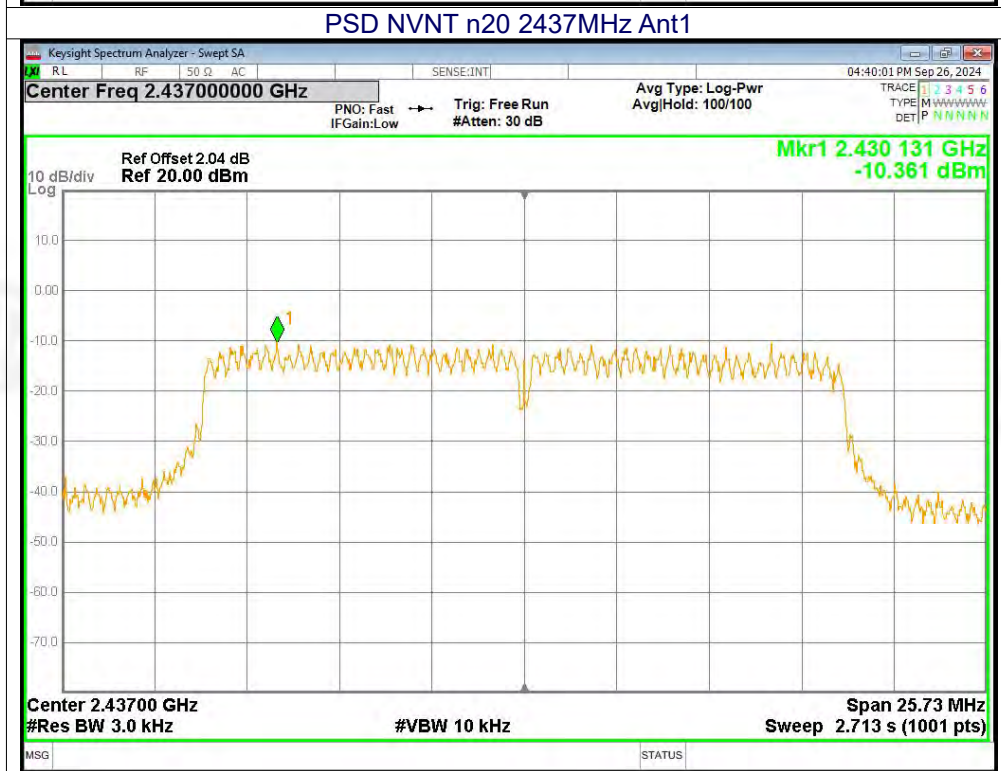

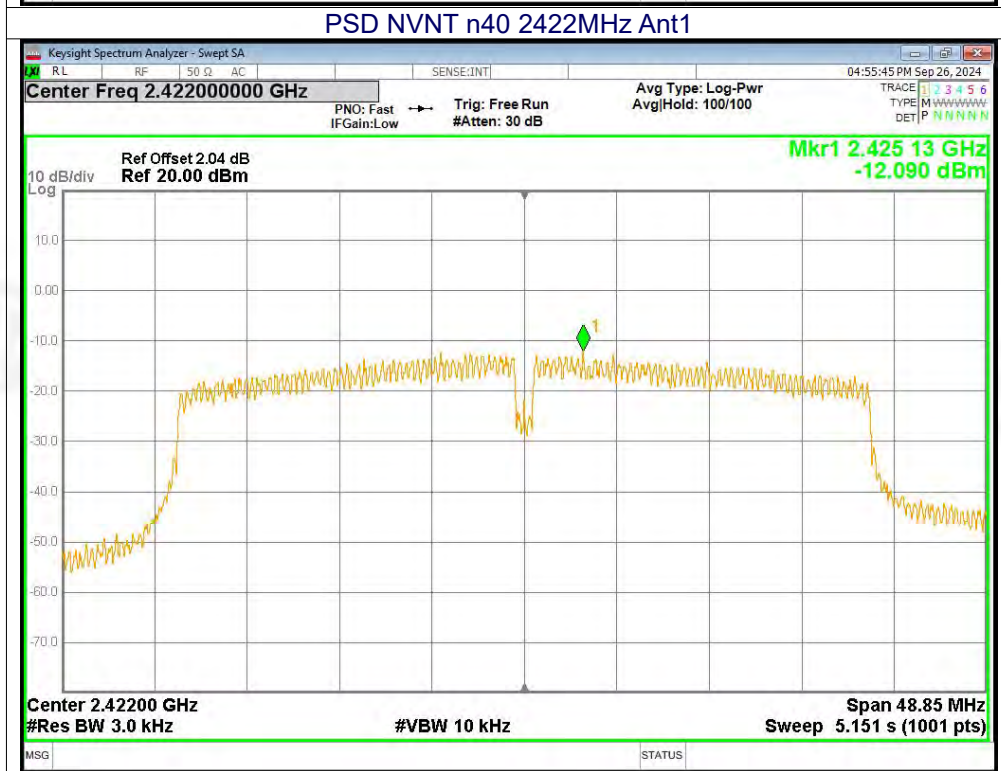
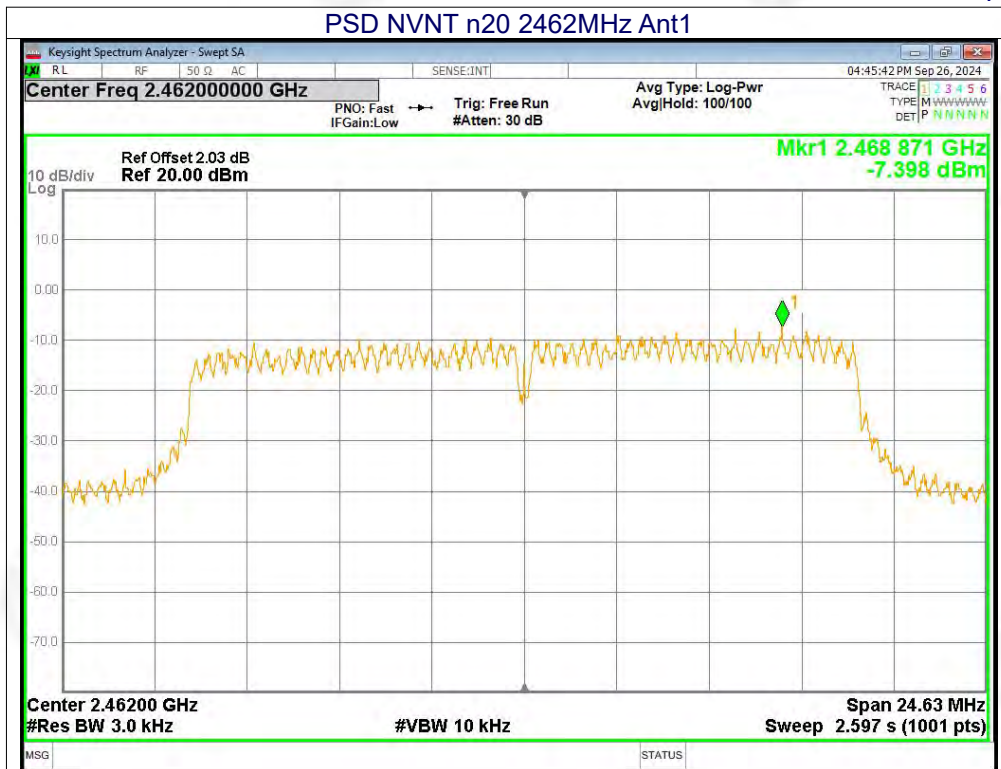

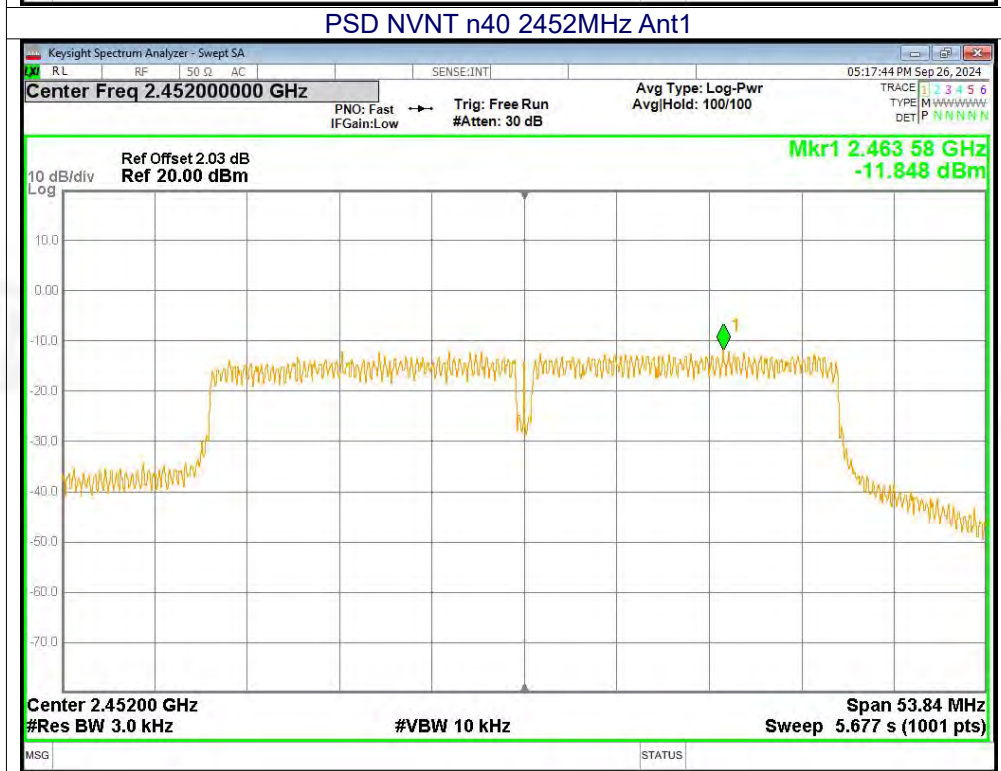
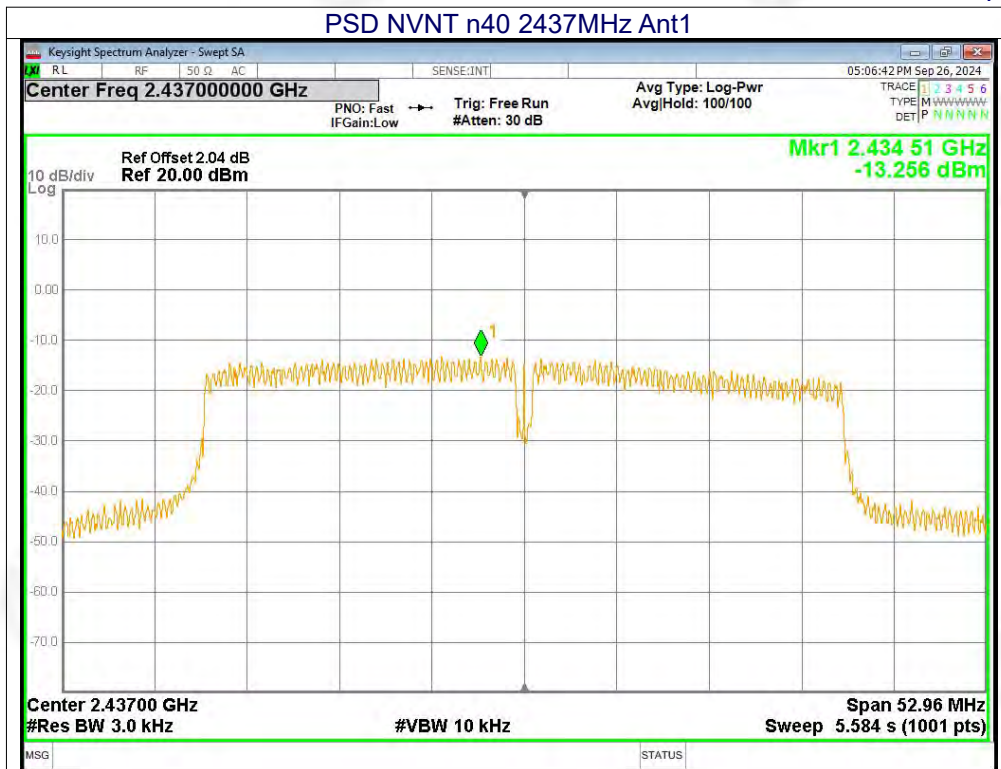



## 11.6 BAND EDGE

Mode	Frequency (MHz)	Max Value (dBc)	Limit (dBc)	Verdict
b	2412	-46.13	-20	Pass
b	2462	-62.71	-20	Pass
g	2412	-31.86	-20	Pass
g	2462	-45.95	-20	Pass
n20	2412	-29.89	-20	Pass
n20	2462	-42.28	-20	Pass
n40	2422	-36.13	-20	Pass
n40	2452	-35.8	-20	Pass

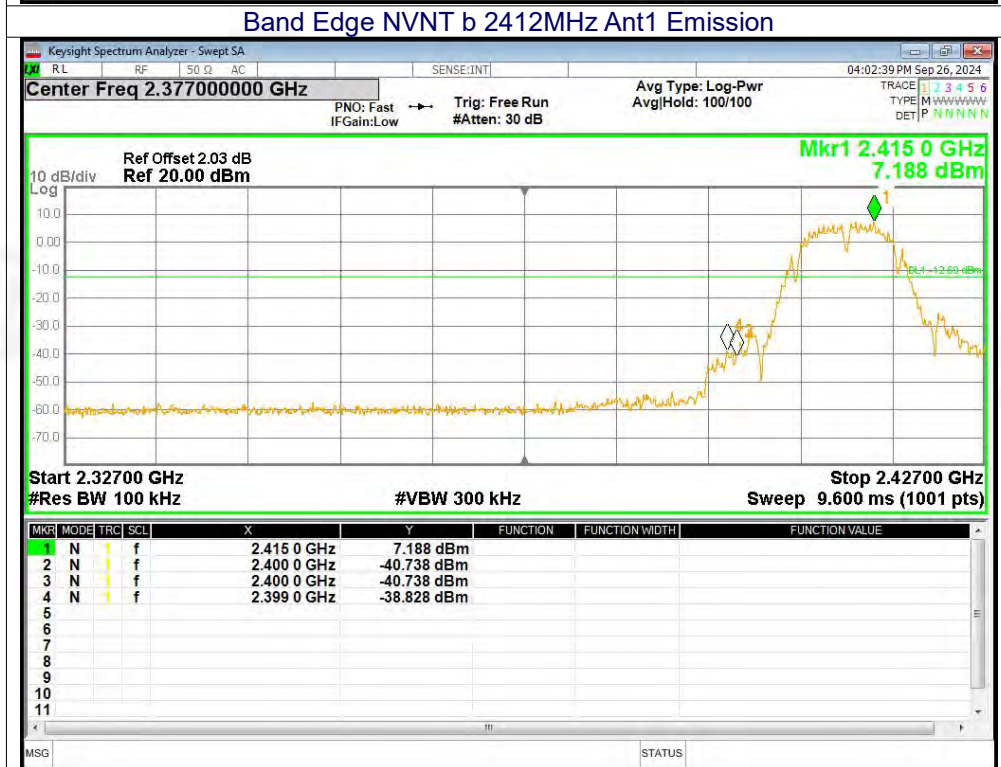
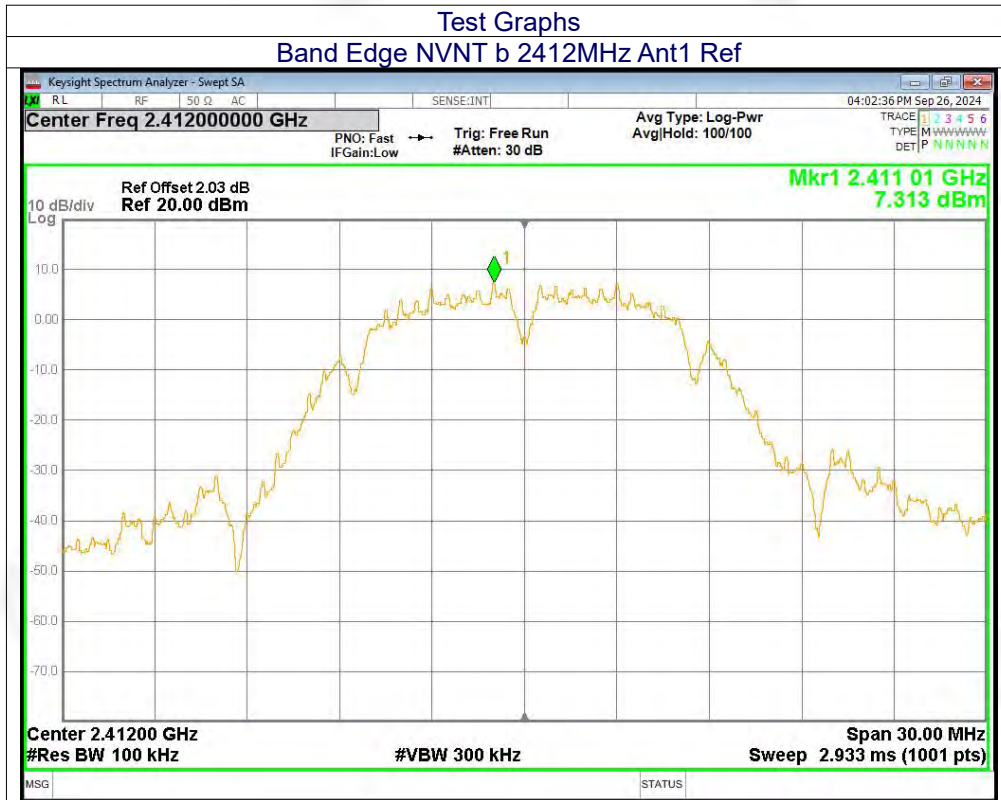

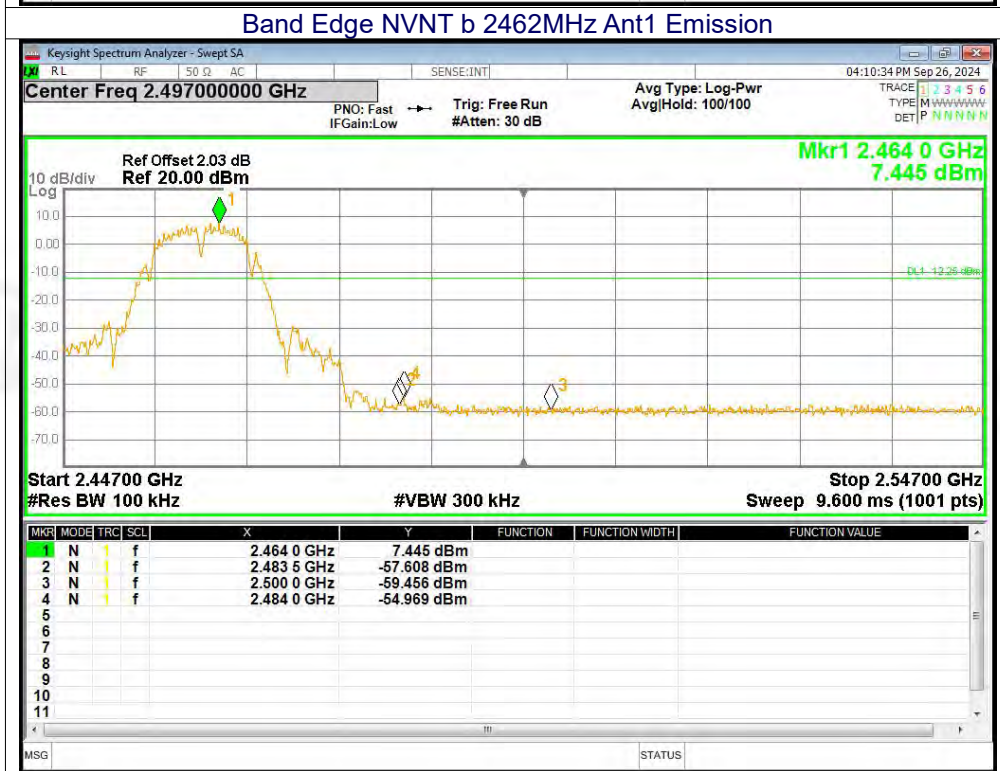
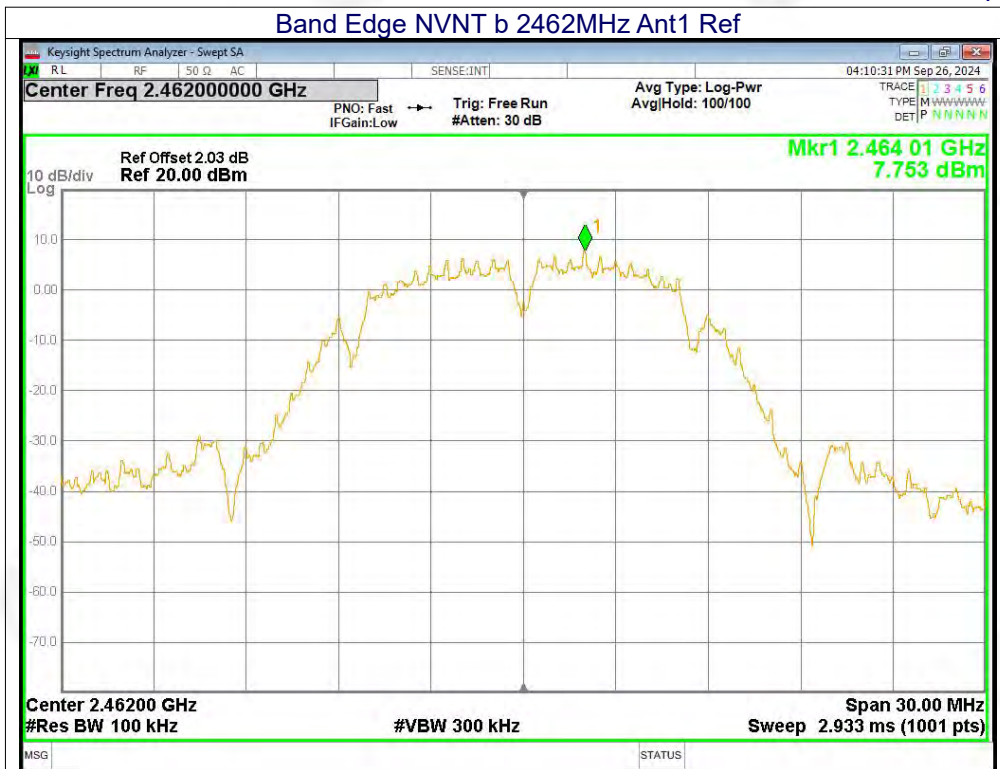



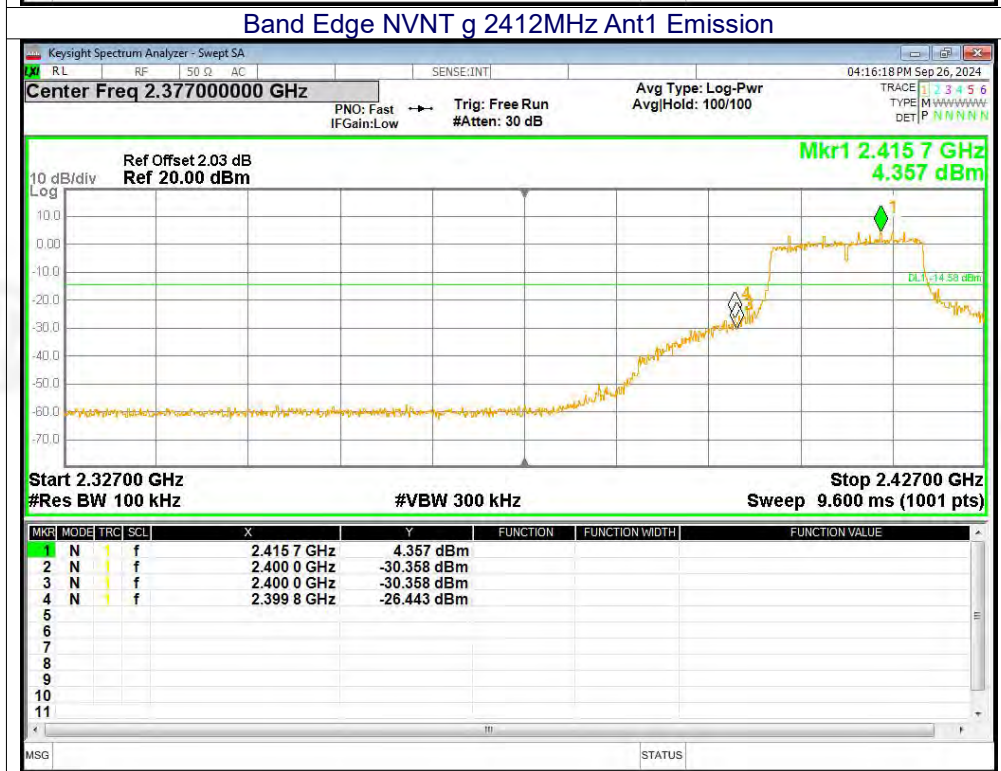
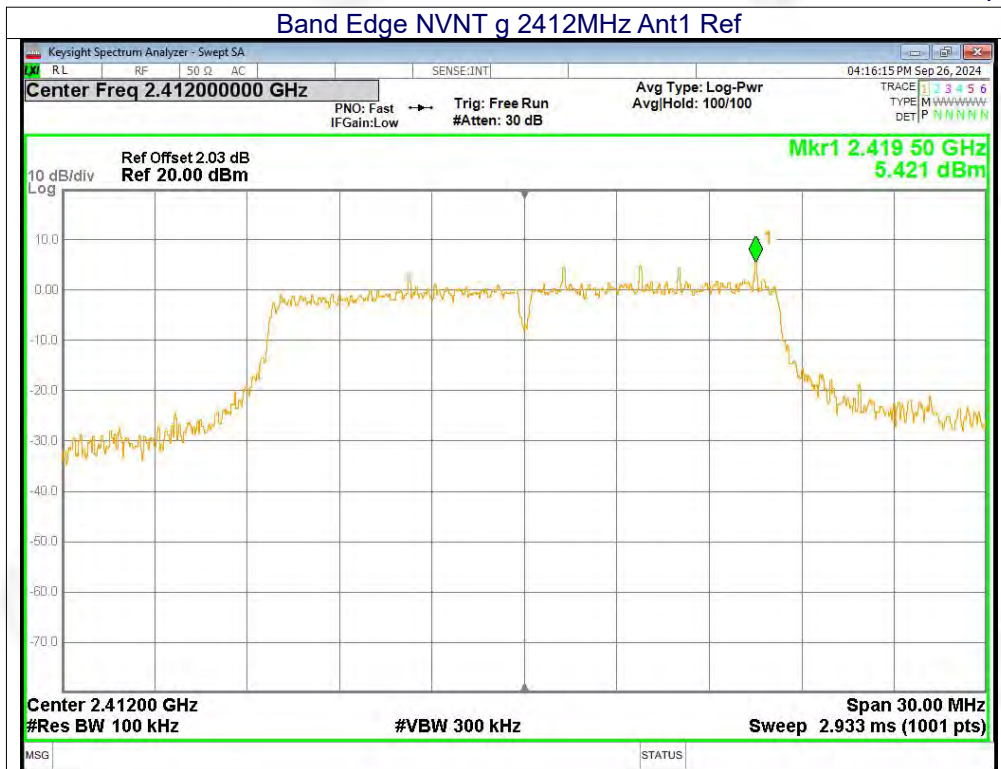

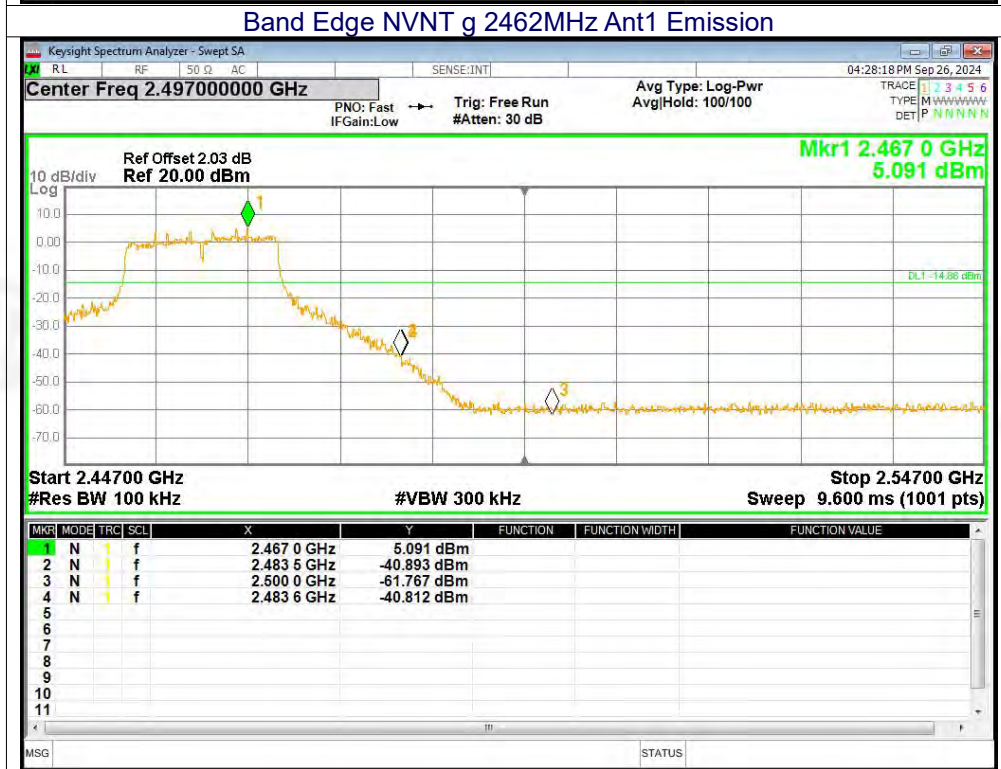
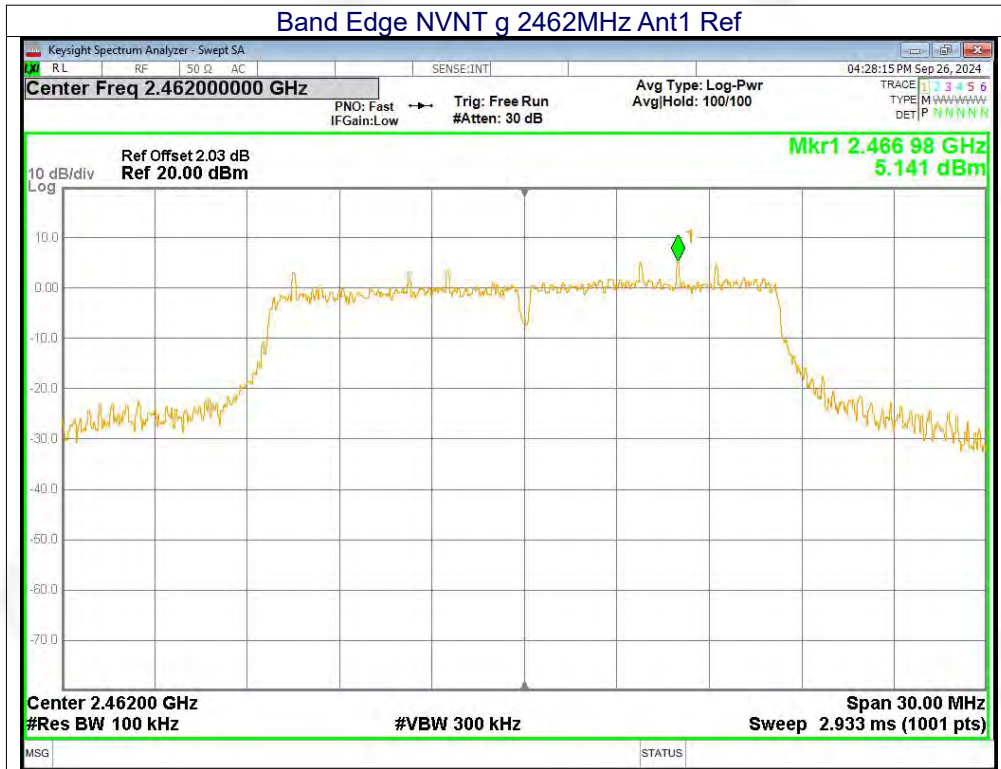

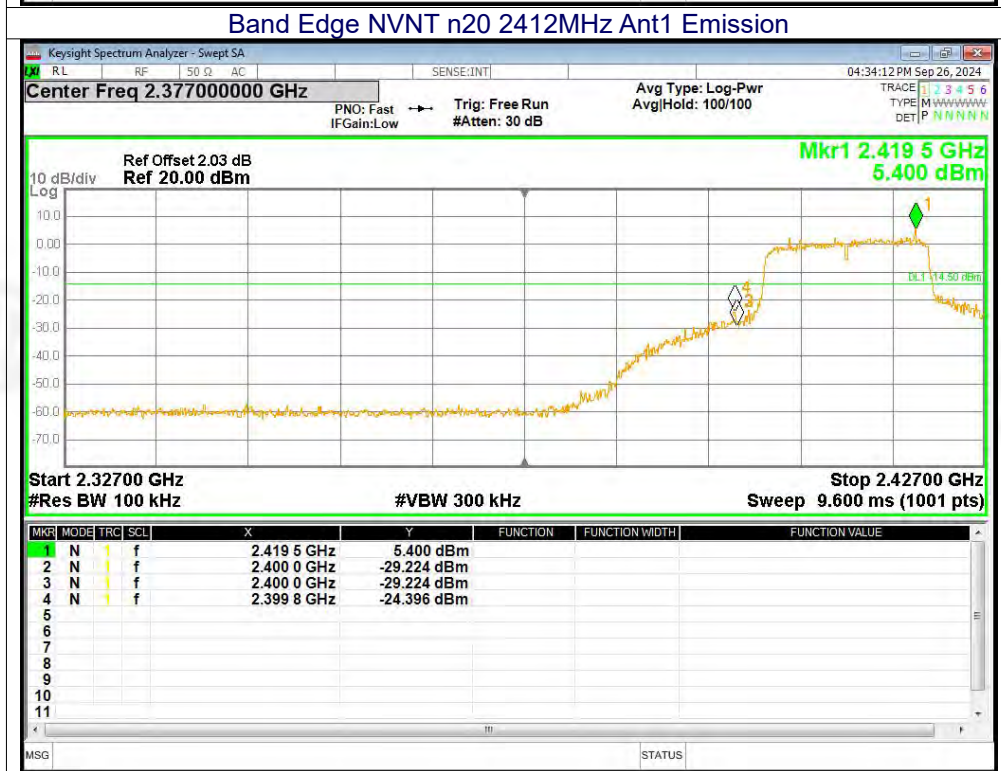
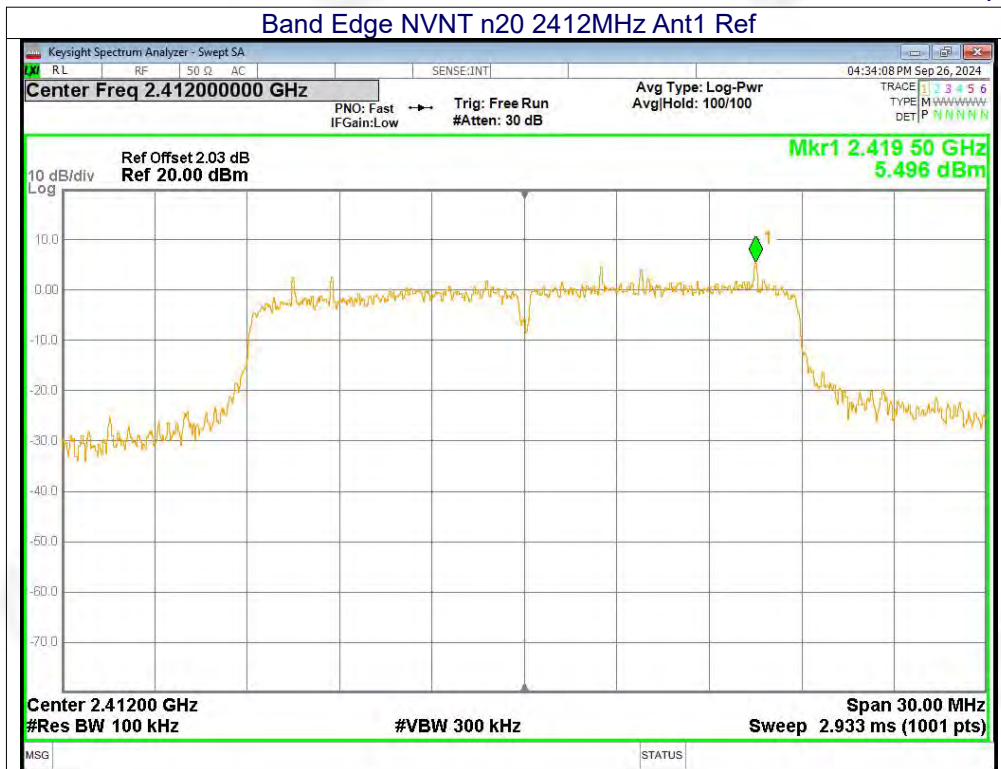

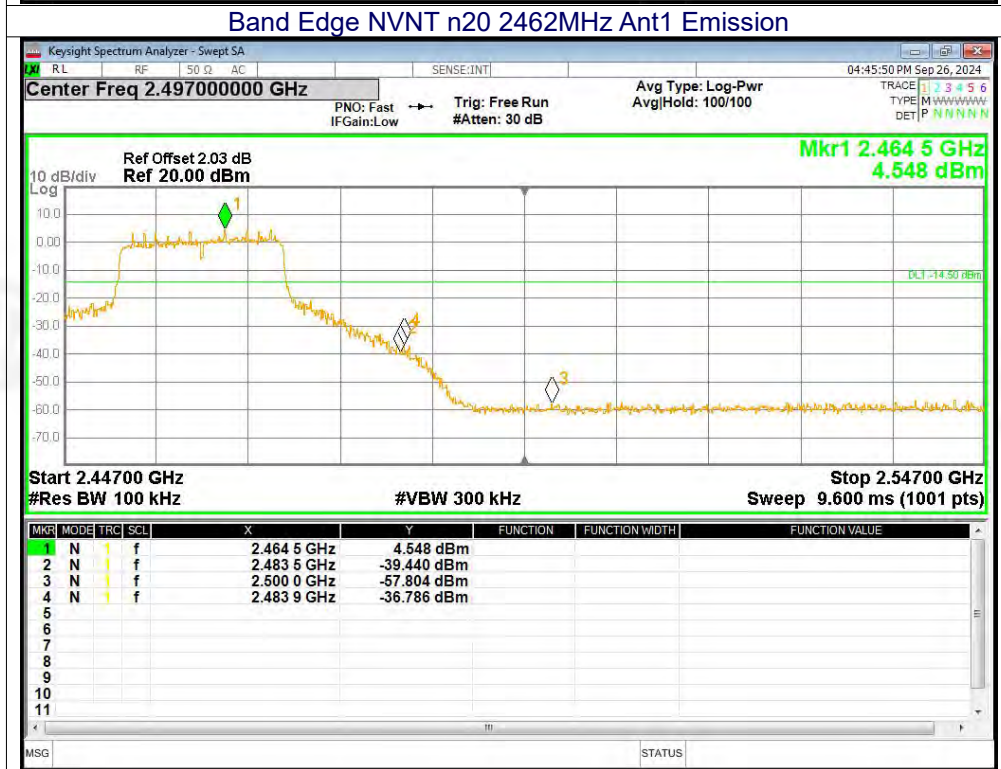
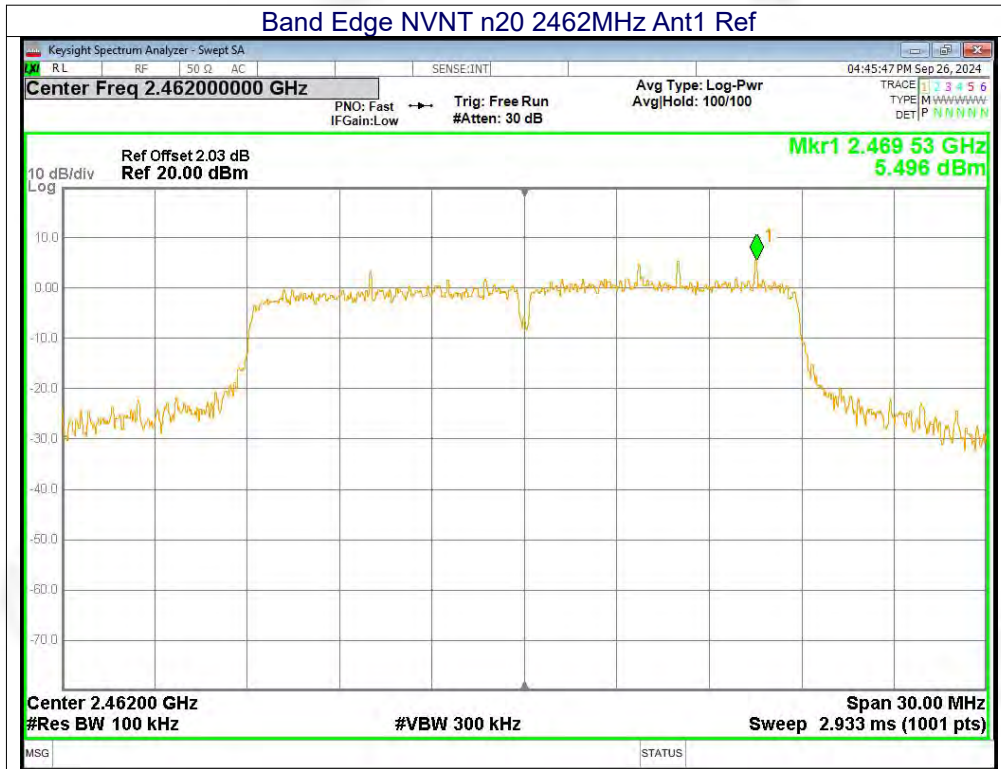

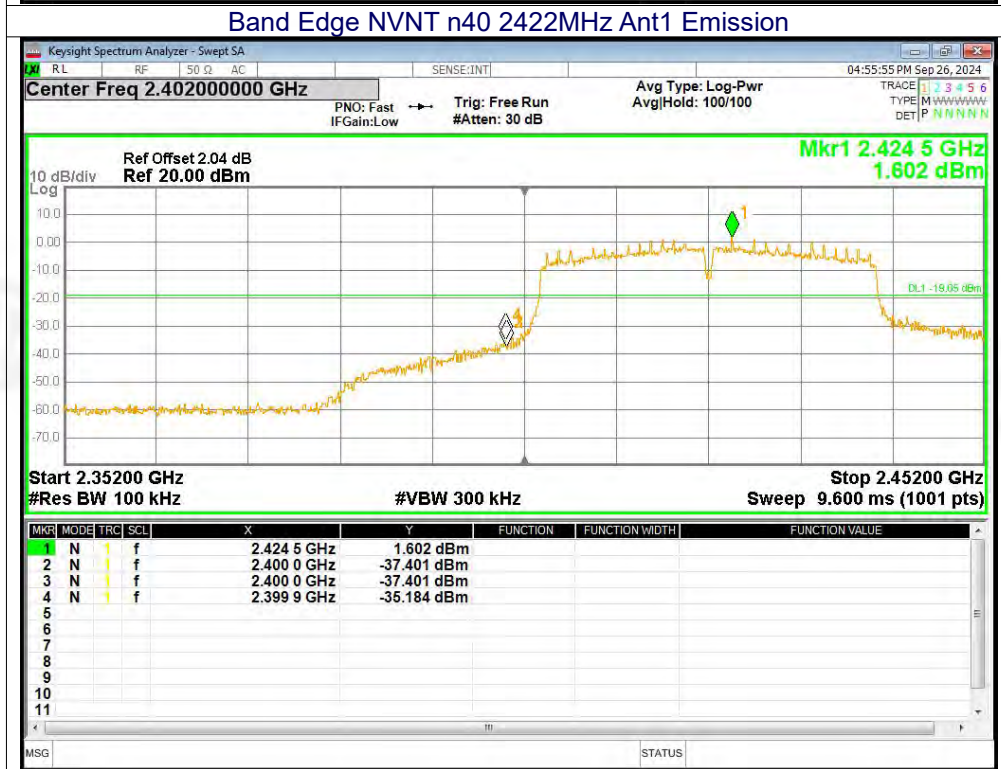

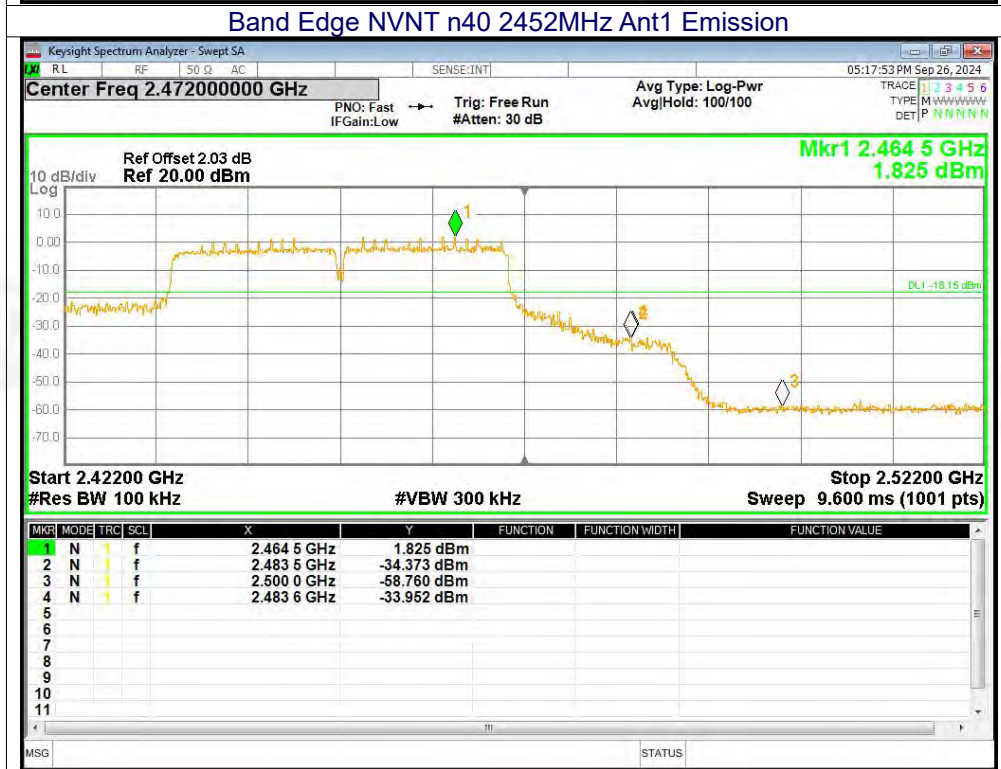
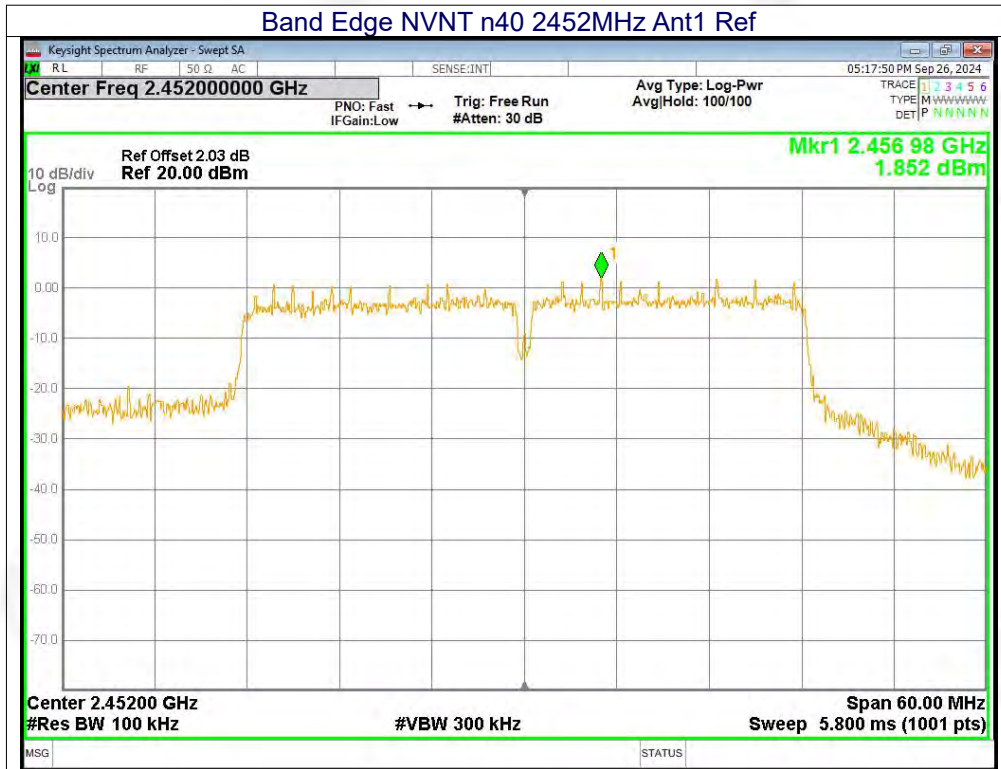



## 11.7 CONDUCTED RF SPURIOUS EMISSION

Mode	Frequency (MHz)	Max Value (dBc)	Limit (dBc)	Verdict
b	2412	-53.99	-20	Pass
b	2437	-52.67	-20	Pass
b	2462	-54.25	-20	Pass
g	2412	-50.99	-20	Pass
g	2437	-48.74	-20	Pass
g	2462	-51.16	-20	Pass
n20	2412	-51.18	-20	Pass
n20	2437	-49.46	-20	Pass
n20	2462	-51.64	-20	Pass
n40	2422	-47.87	-20	Pass
n40	2437	-46.84	-20	Pass
n40	2452	-47.3	-20	Pass

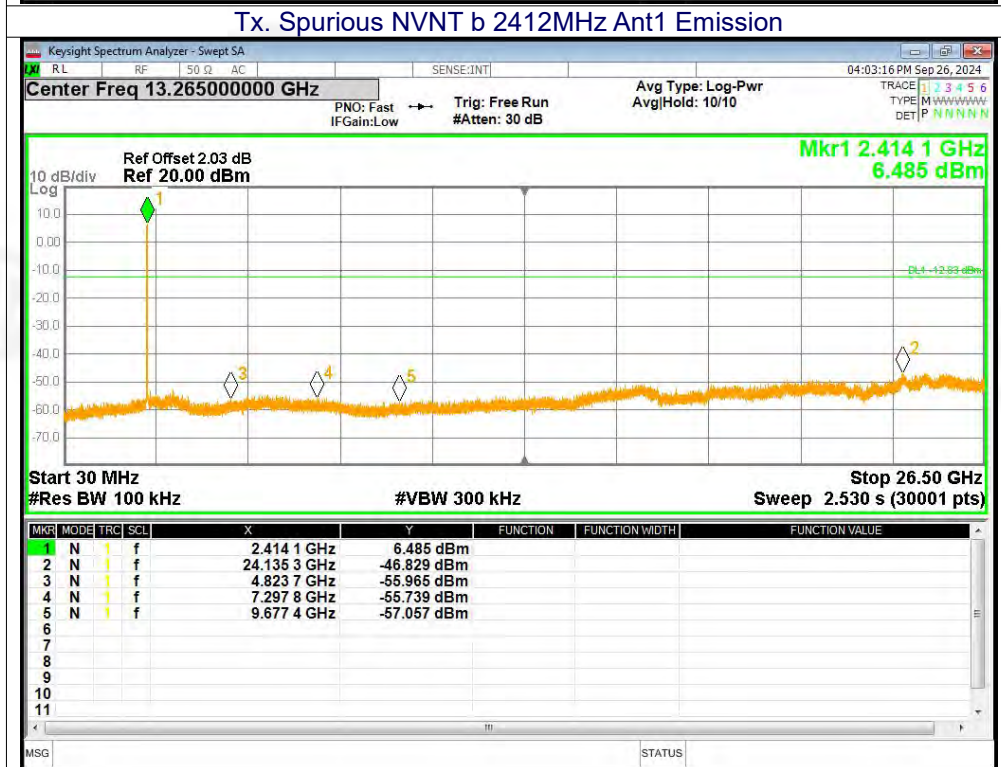
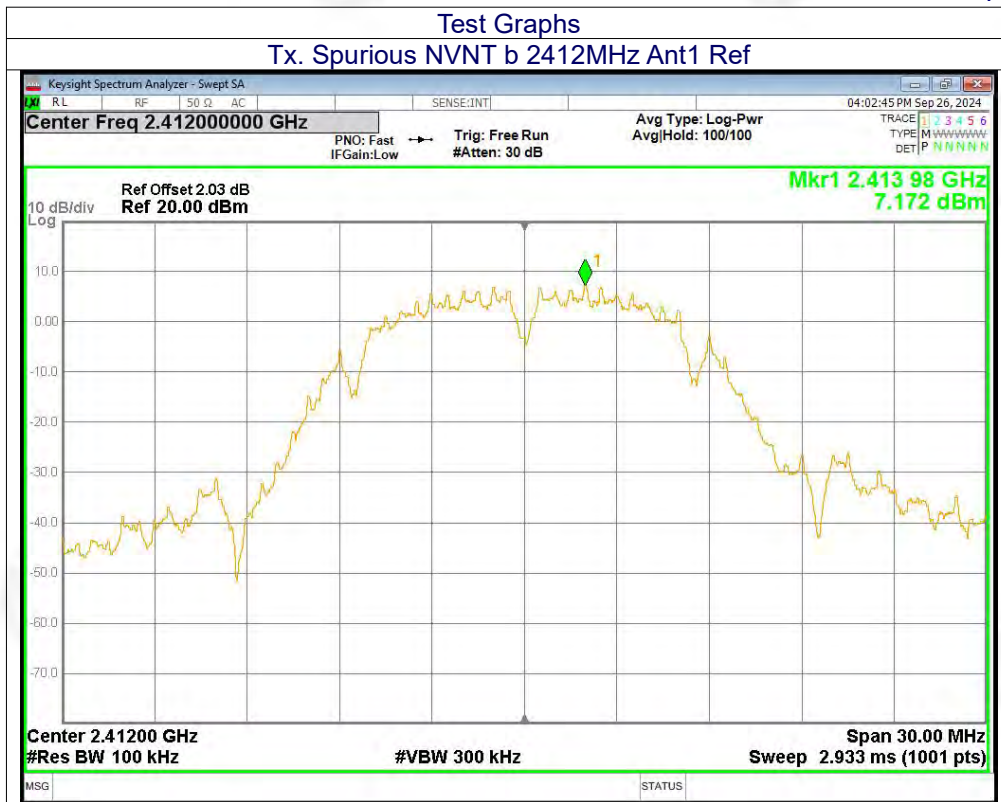



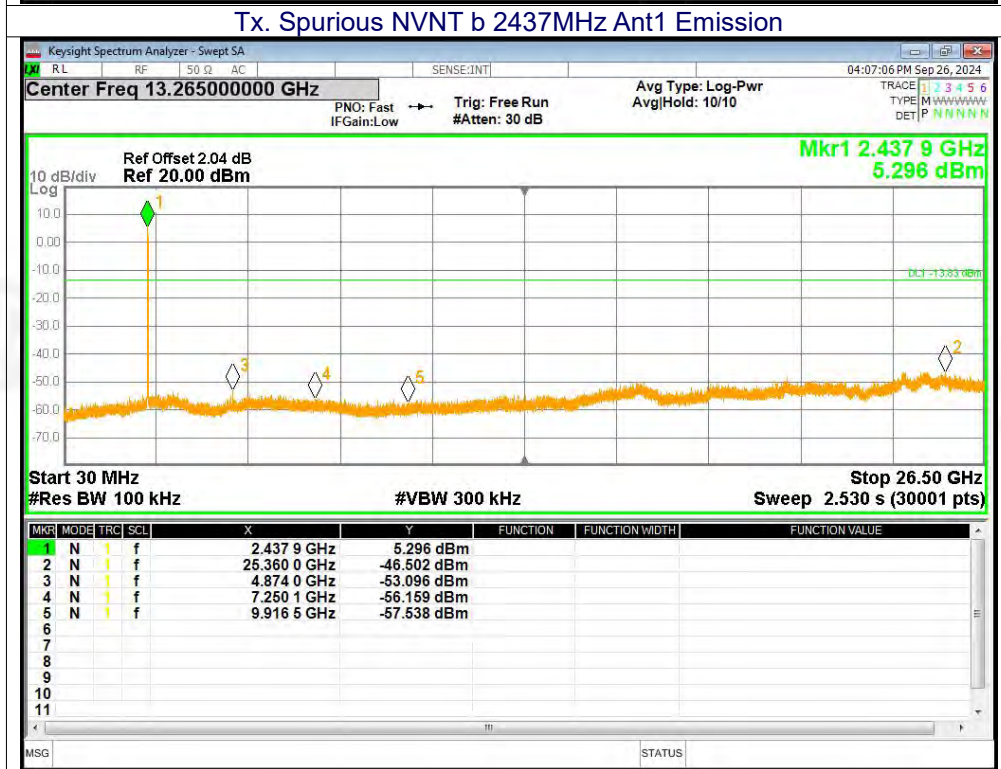

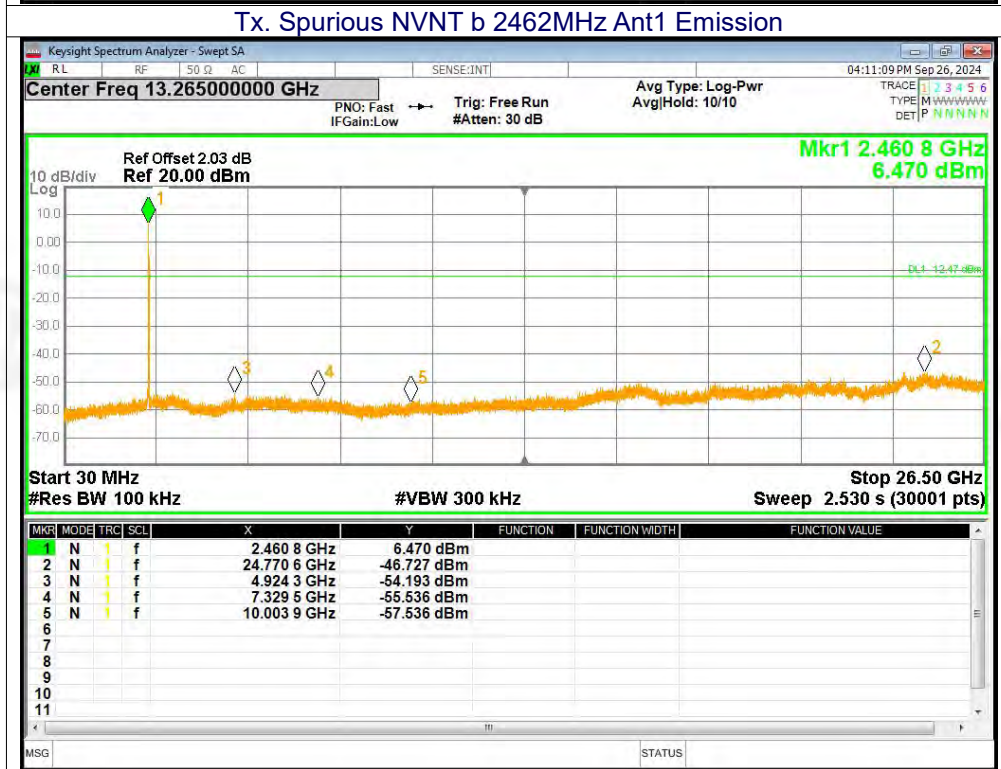

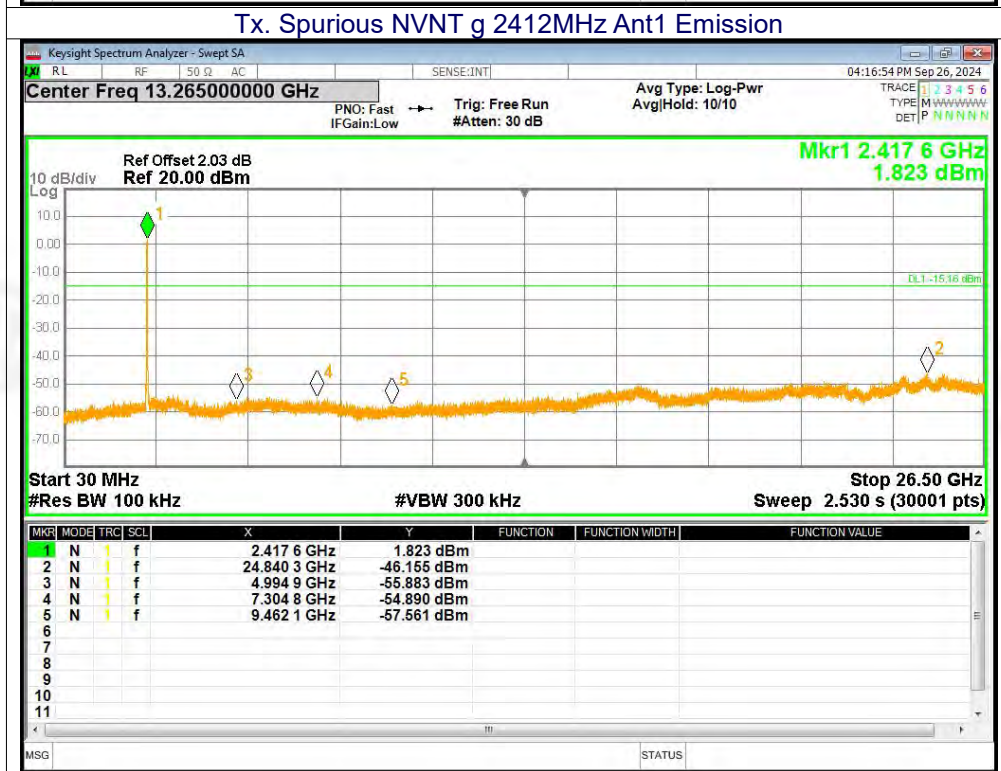
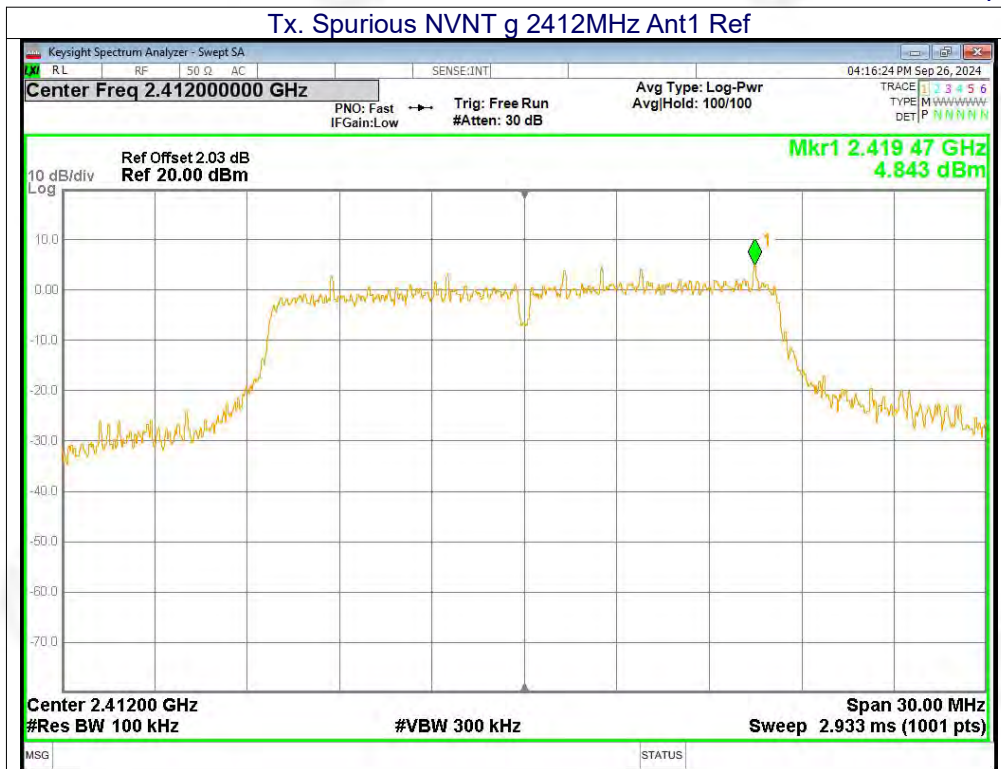

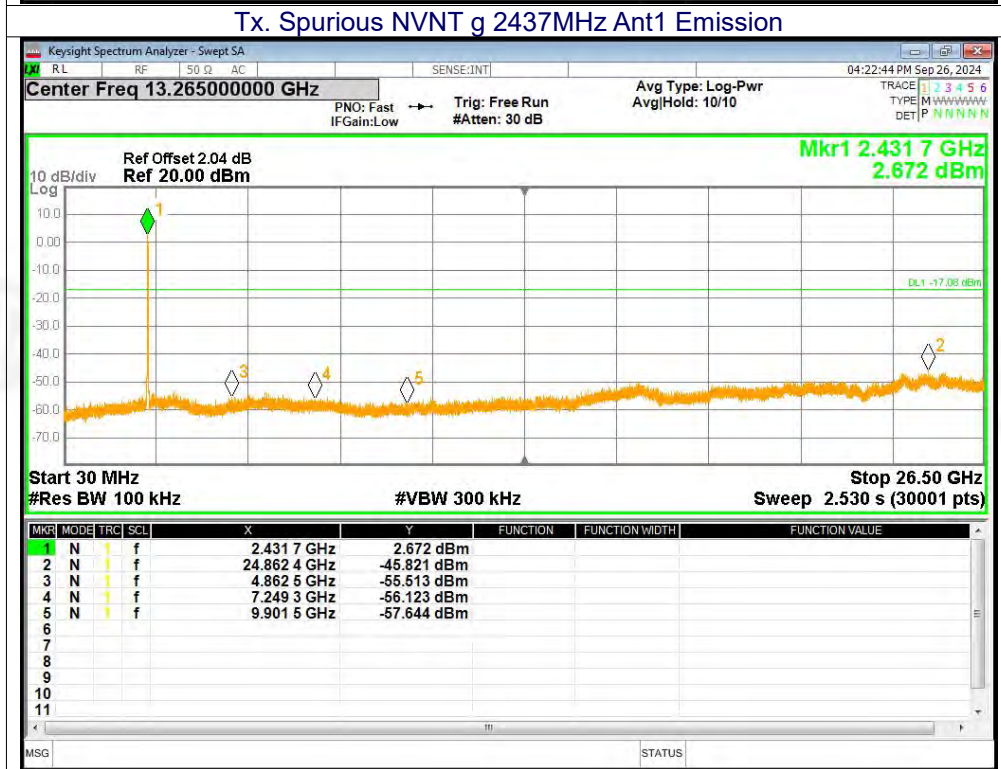
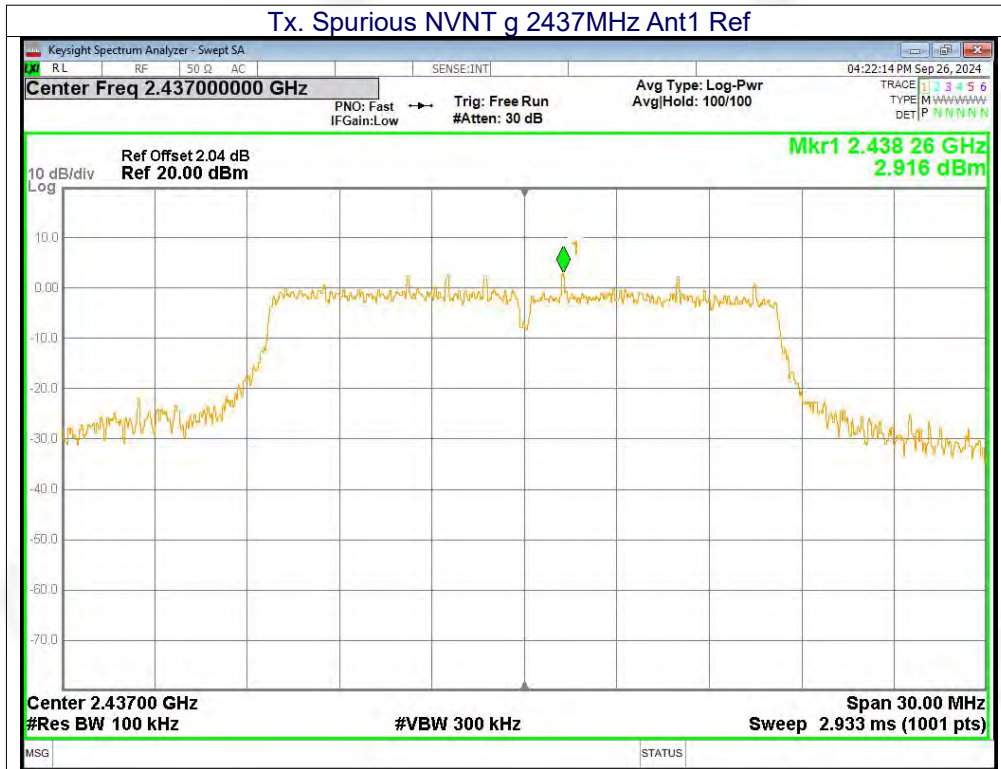

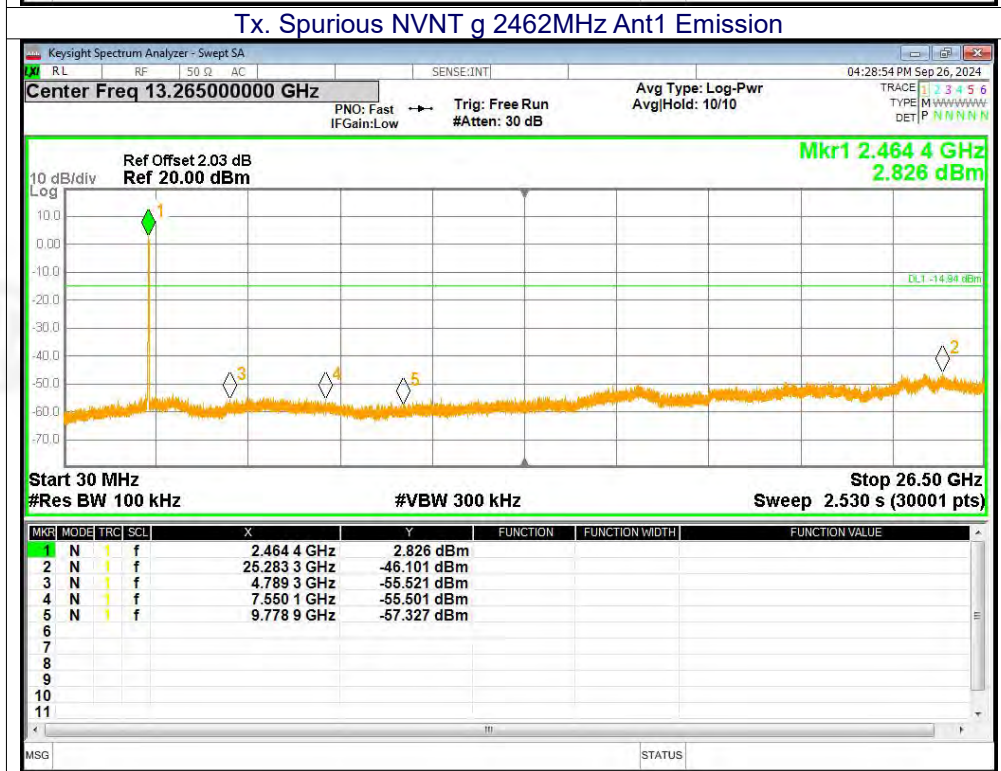
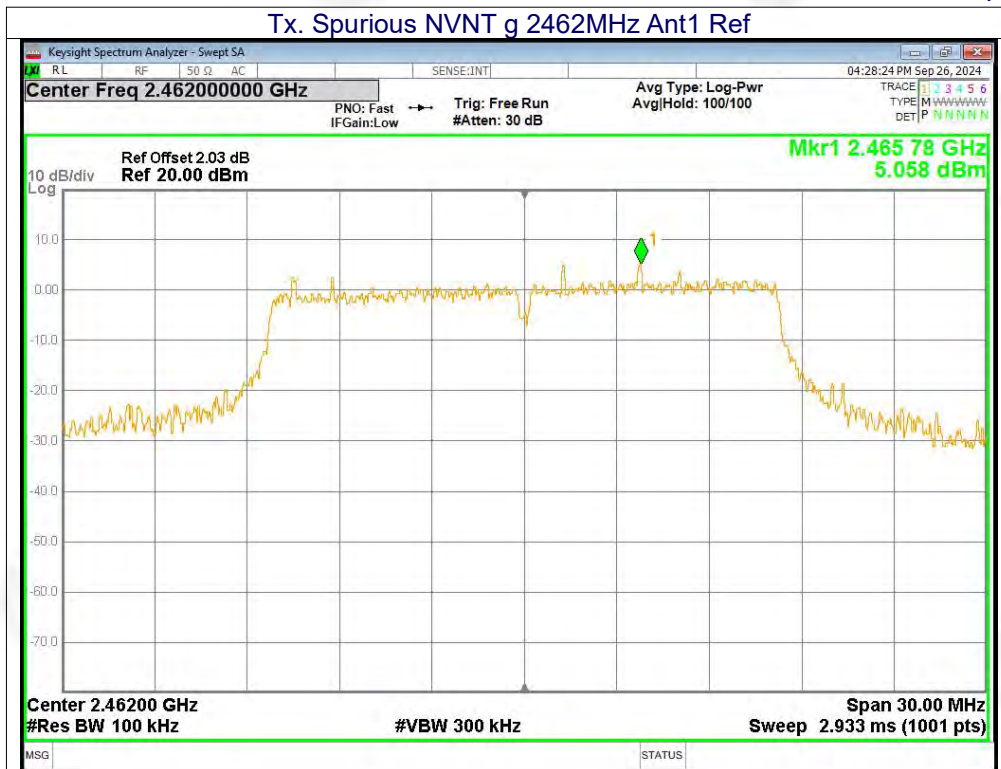

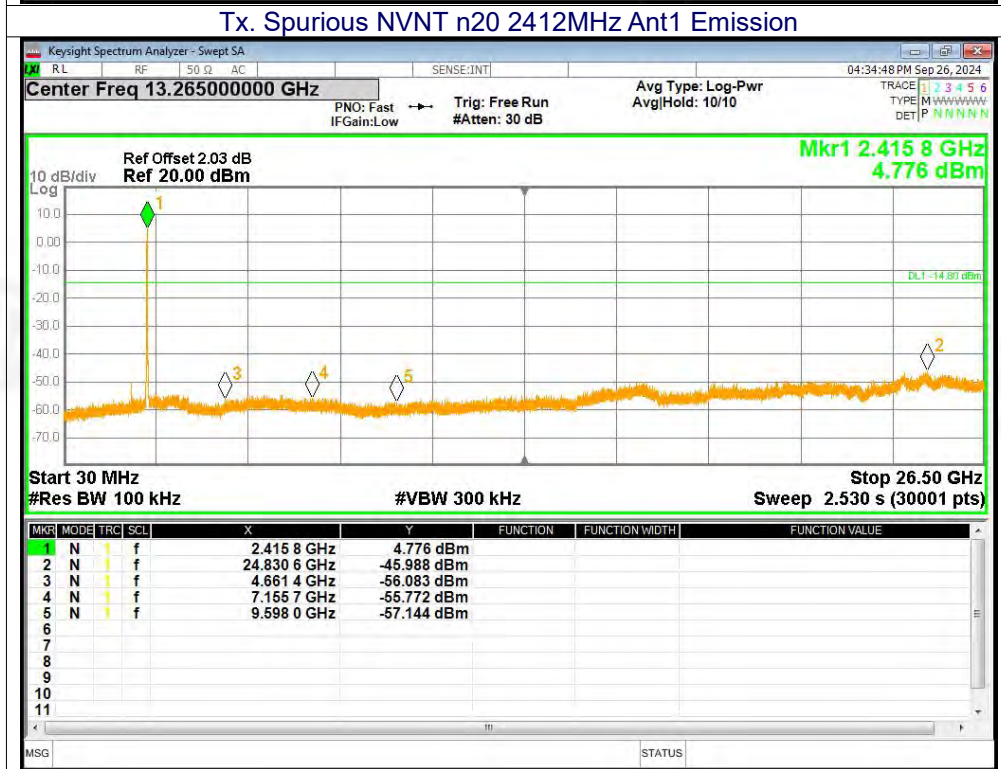
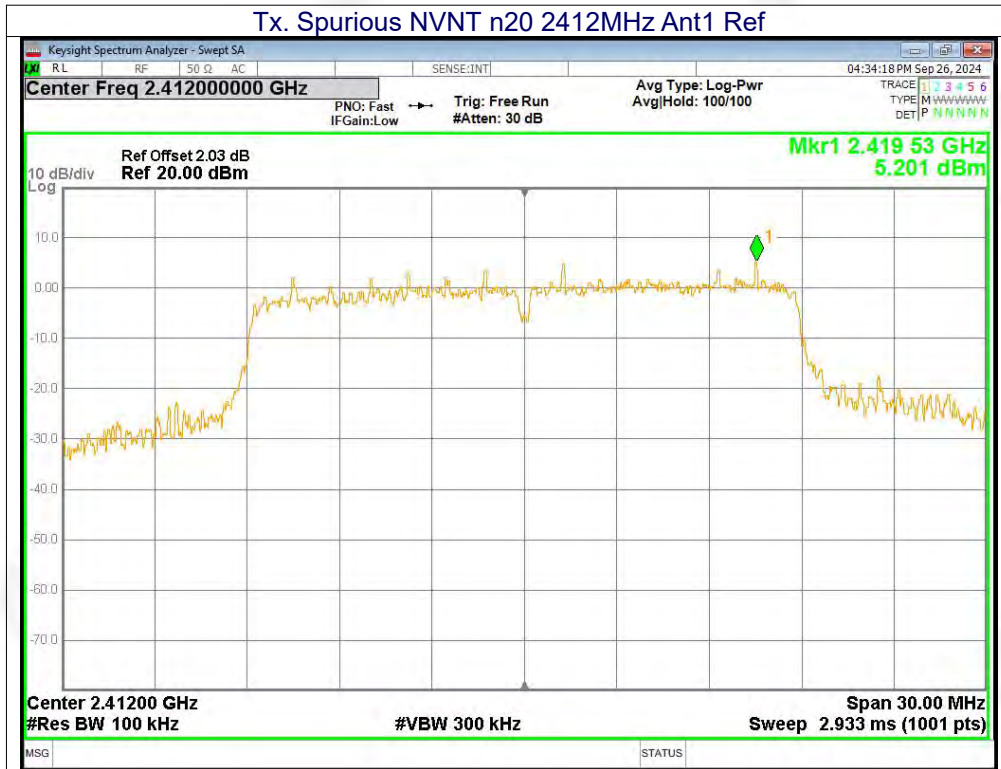

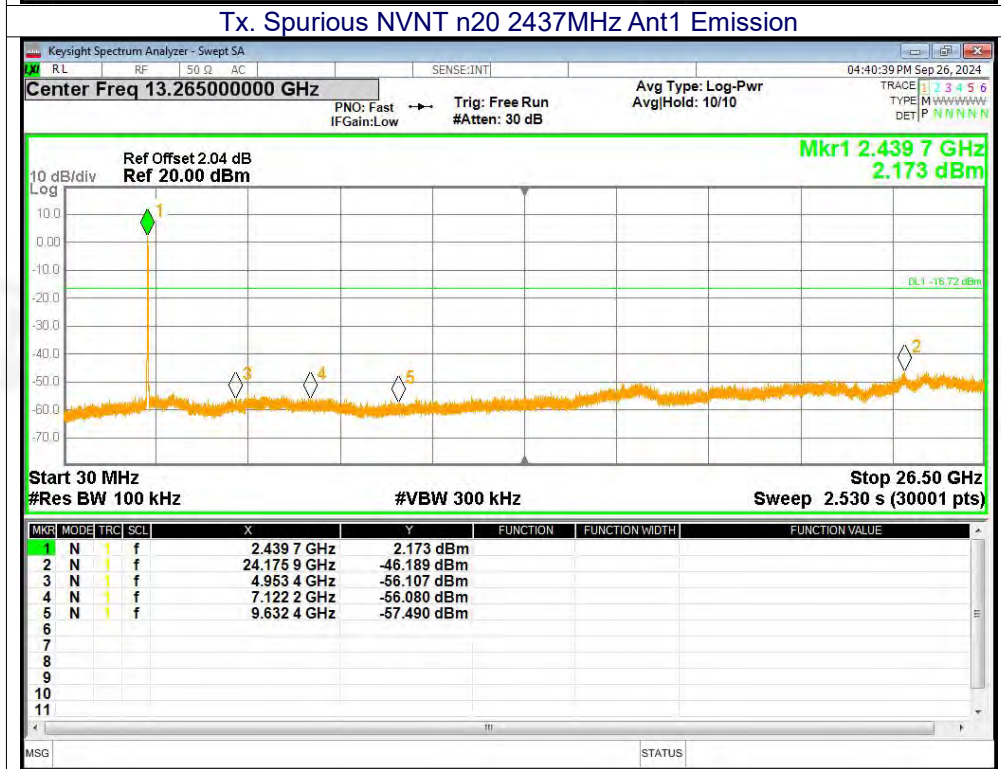
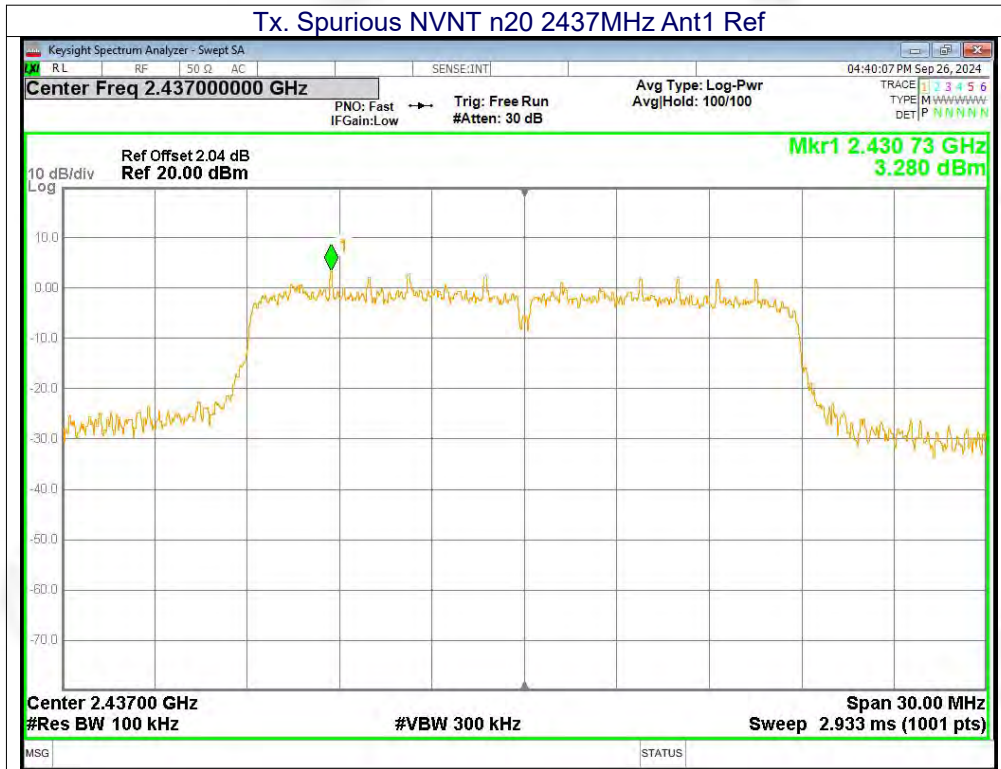

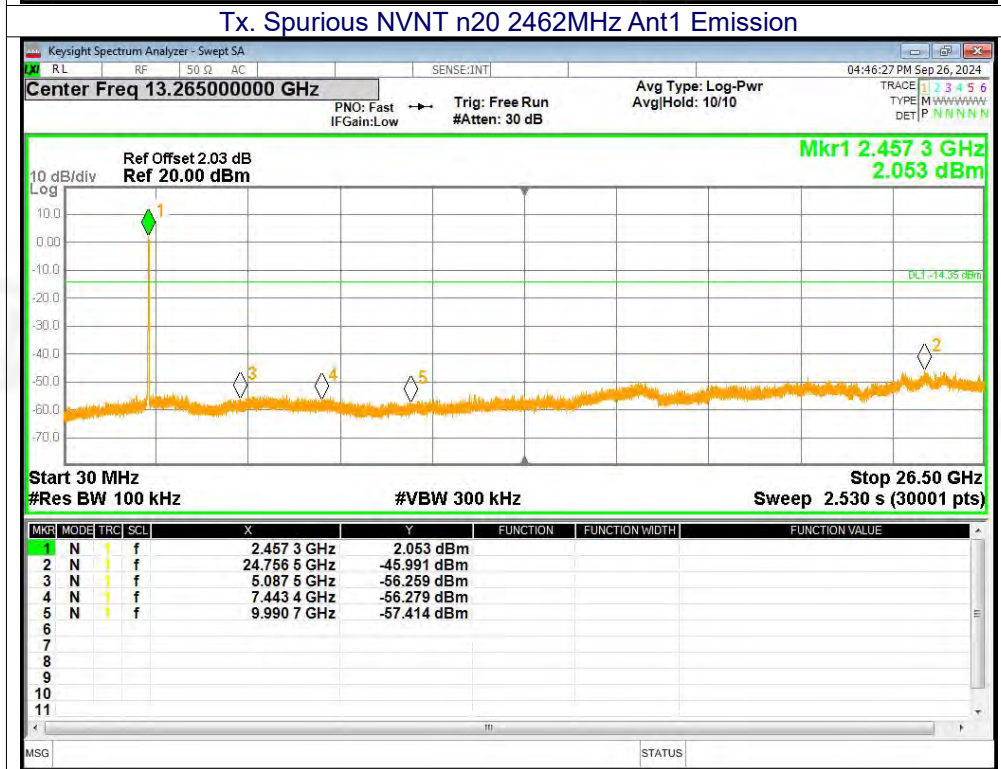
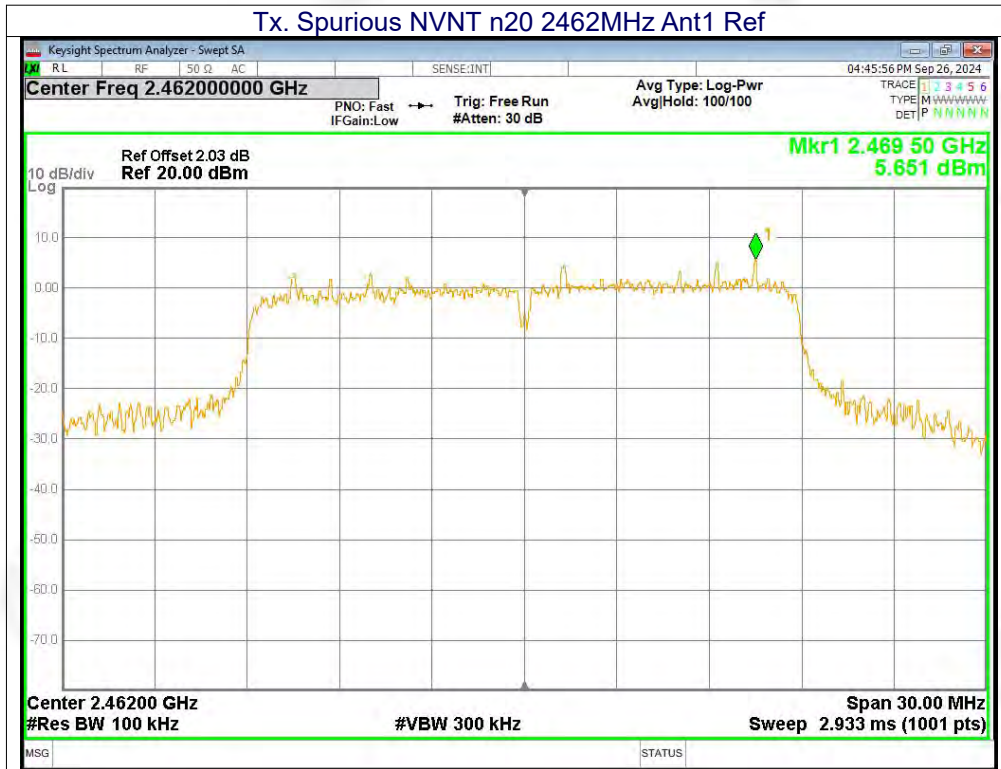





### Tx. Spurious NVNT n40 2422MHz Ant1 Ref

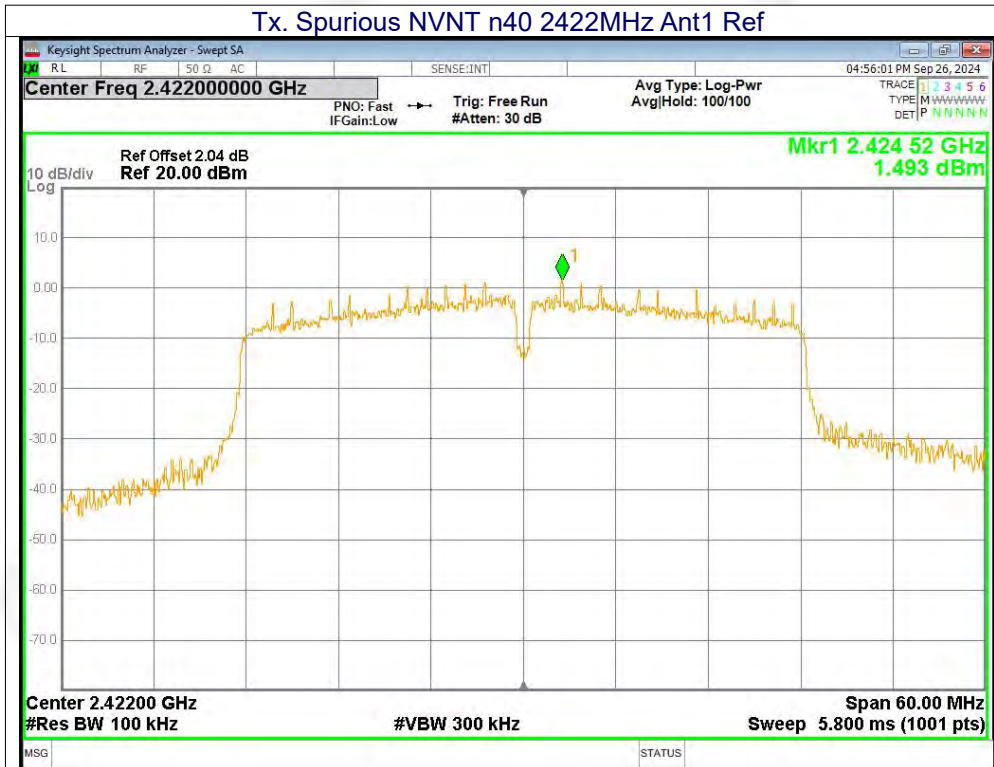

### Tx. Spurious NVNT n40 2422MHz Ant1 Emission

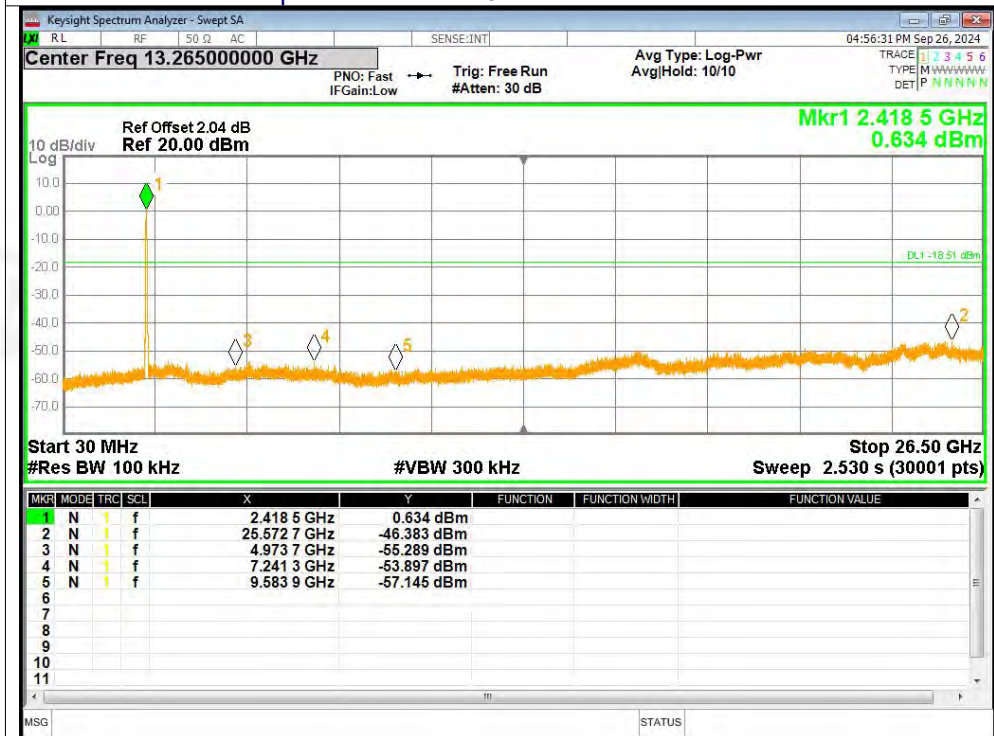



### Tx. Spurious NVNT n40 2437MHz Ant1 Ref

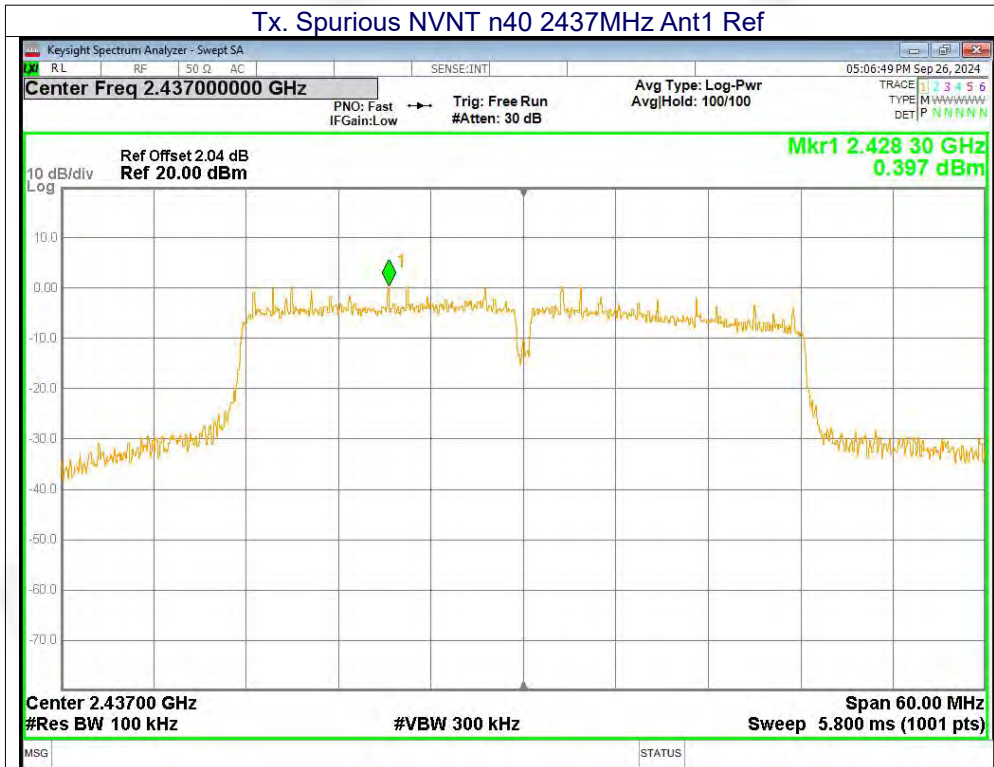

### Tx. Spurious NVNT n40 2437MHz Ant1 Emission

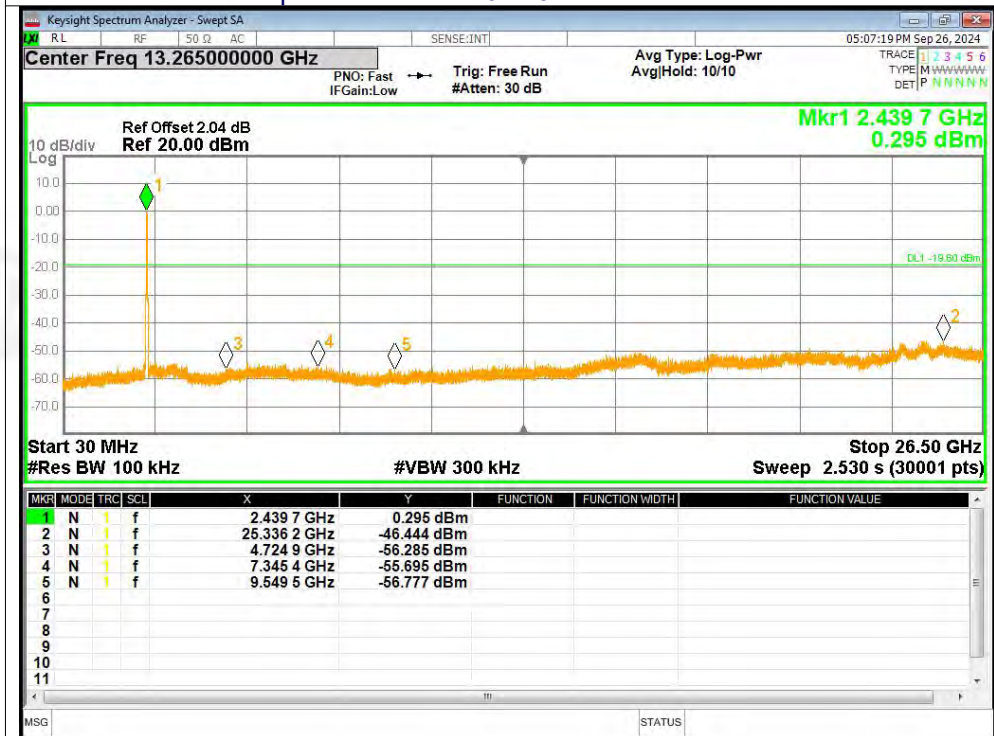

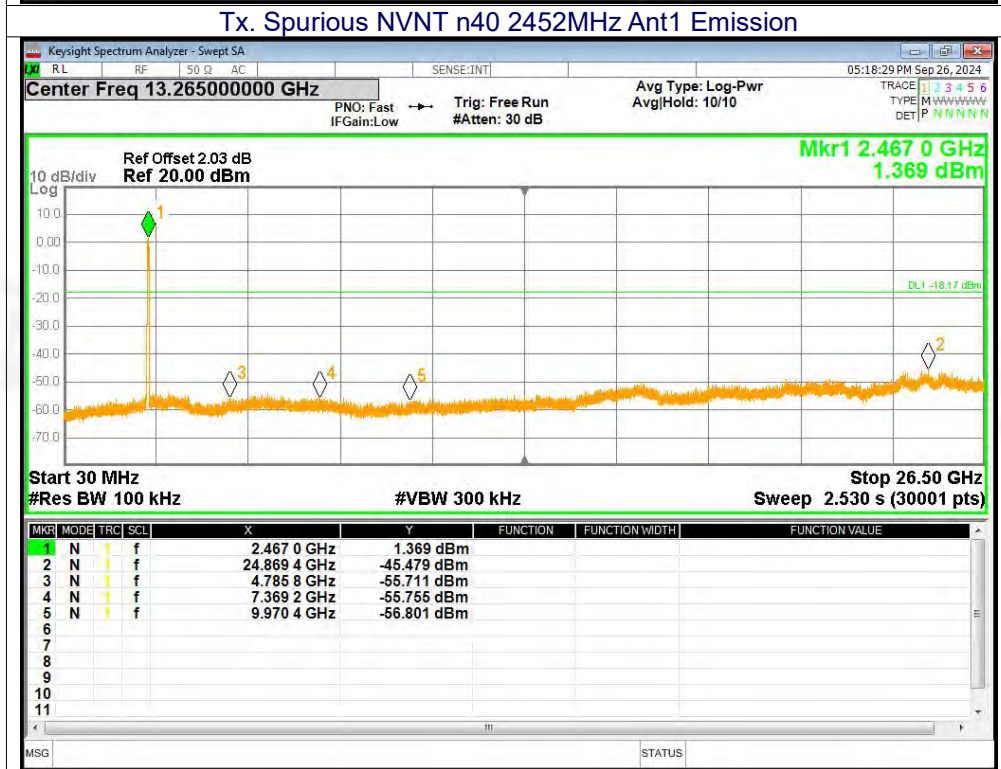
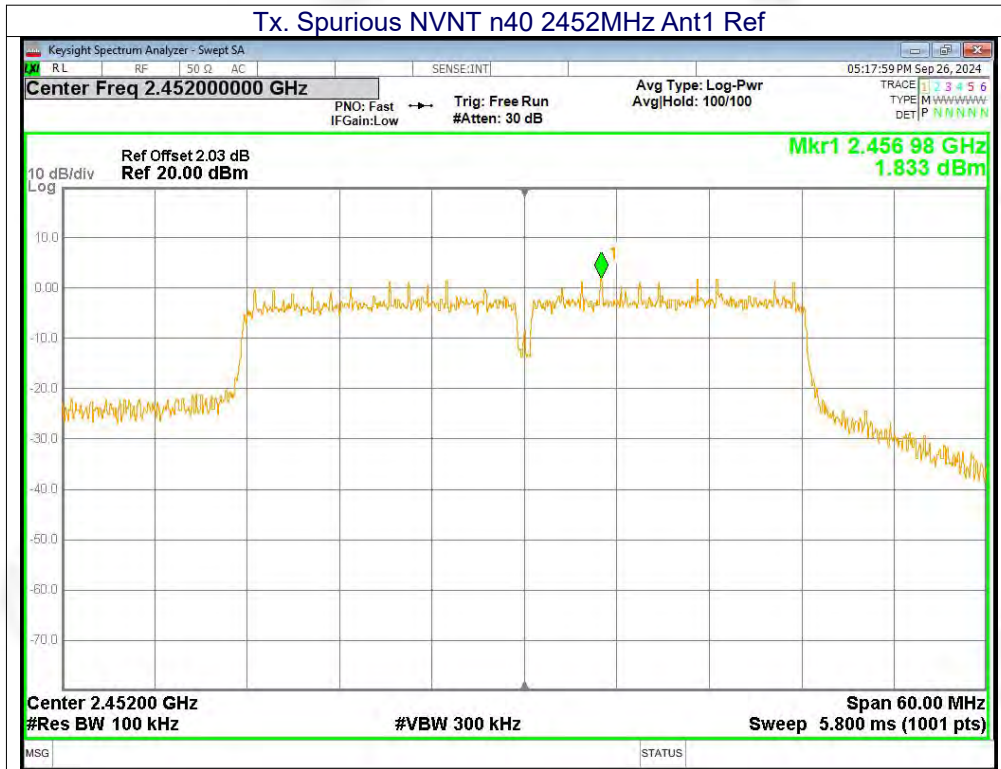



## 12. TEST SETUP PHOTO

Reference to the appendix I for details.

## 13. EUT CONSTRUCTIONAL DETAILS

Reference to the appendix II for details.

\*\*\*\*\* END OF REPORT \*\*\*\*\*