

# TEST REPORT

Report No.: SHE23100101-01DE

Date: 2024-05-30

Page 1 of 36

**Applicant** : SKYTECH USA LLC.  
**Address of Applicant** : INCORP SERVICES, INC. 3458 LAKESHORE DRIVE  
TALLAHASSEE, FL 32312 US

**Product Name** : ALL IN ONE  
**Brand Name** : STGsivir & STGSivir  
**Model Name** : SIV0123  
**Sample Acquisition Method** : Sent by Client  
**Sample No.** : E23100101-01#01

**FCC ID** : 2BGCASIV0123

**Standards** : FCC CFR47 Part 15, Subpart C

**Date of Receipt** : 2023-11-03  
**Date of Test** : 2023-11-03~ 2024-04-28  
**Date of Issue** : 2024-05-30

**Remark:**

*This report details the results of the testing carried out on one sample, the results contained in this report do not relate to other samples of the same product. The manufacturer should ensure that all products in series production are in conformity with the product sample detailed in this report.*

Prepared by:



(Erik Yang)

Reviewed by:



(Jennifer Zhou)

Approved by:



(Authorized signatory: Echo Mu)

# TEST REPORT

Report No.: SHE23100101-01DE

Date: 2024-05-30

Page 2 of 36

## Contents

<b>1</b>	<b>GENERAL INFORMATION</b>	<b>3</b>
1.1	TESTING LABORATORY	3
1.2	DETAILS OF APPLICATION	3
1.3	DETAILS OF EUT	3
1.4	TEST METHODOLOGY	4
1.5	TEST SUMMARY	5
<b>2</b>	<b>TEST CONDITION</b>	<b>6</b>
2.1	ENVIRONMENTAL CONDITIONS	6
2.2	EQUIPMENT LIST	6
2.3	MEASUREMENT UNCERTAINTY	7
<b>3</b>	<b>TEST SET-UP AND OPERATION MODES</b>	<b>8</b>
3.1	DETAILS OF TEST MODE	8
3.2	SPECIAL ACCESSORIES AND AUXILIARY EQUIPMENT	8
3.3	SUPPORT SOFTWARE	8
3.4	TEST SETUP DIAGRAM	9
<b>4</b>	<b>TEST RESULTS</b>	<b>11</b>
4.1	TRANSMITTER REQUIREMENT & TEST SUITES	11
4.1.1	<i>Antenna Requirement</i>	11
4.1.2	<i>Maximum peak conducted output power</i>	12
4.1.3	<i>6dB Bandwidth and 99% Bandwidth</i>	14
4.1.4	<i>Maximum conducted output power spectral density</i>	18
4.1.5	<i>Conducted Spurious Emission &amp; Authorized-band band-edge</i>	20
4.1.6	<i>Radiated Emission</i>	27
4.1.7	<i>Band Edge (Restricted-band band-edge)</i>	28
4.2	MAINS EMISSIONS	29
4.2.1	<i>Conducted Emission on AC Mains</i>	29
<b>5</b>	<b>APPENDIXES</b>	<b>32</b>
5.1	PHOTOGRAPHS OF THE SAMPLE	32
5.2	SET-UP FOR CONDUCTED EMISSIONS	35
5.3	SET-UP FOR CONDUCTED RF TEST AT ANTENNA PORT	35
5.4	SET-UP FOR SPURIOUS EMISSIONS BELOW 1GHZ	36
5.5	SET-UP FOR SPURIOUS EMISSIONS ABOVE 1GHZ	36

# TEST REPORT

Report No.: SHE23100101-01DE

Date: 2024-05-30

Page 3 of 36

## 1 General Information

### 1.1 Testing Laboratory

Company Name	ICAS Testing Technology Service (Shanghai) Co., Ltd.
Address	No.1298, Pingan Road, Minhang District, Shanghai, China
Telephone	0086 21-51682999
Fax	0086 21-54711112
Homepage	www.icasiso.com

### 1.2 Details of Application

Applicant Company Name	SKYTECH USA LLC.
Address	INCORP SERVICES, INC. 3458 LAKESHORE DRIVE TALLAHASSEE, FL 32312 US
Contact Person	Hu yan
Telephone	001-647-8892-868
Email	yan.hu@astsys.com
Manufacturer Company Name	SKYTECH USA LLC.
Address	INCORP SERVICES, INC. 3458 LAKESHORE DRIVE TALLAHASSEE, FL 32312 US
Factory Company Name	SKYTECH USA LLC.
Address	INCORP SERVICES, INC. 3458 LAKESHORE DRIVE TALLAHASSEE, FL 32312 US

### 1.3 Details of EUT

Product Name	ALL IN ONE
Brand Name	STGsvir & STGSvir
Test Model Name	SIV0123
FCC ID	2BGCASIV0123
Mode of Operation	Bluetooth BLE
Frequency Range	2402MHz ~ 2480MHz
Number of Channels	40 (at intervals of 2 MHz)
Modulation Type	BLE <input checked="" type="checkbox"/> GFSK 1Mbps <input type="checkbox"/> GFSK 2Mbps
Max RF Output Power	-0.19dBm
Antenna Type	Internal Antenna
Antenna Gain	1.83dBi
Extreme Temperature Range	0°C ~ +70°C
Test Voltage	AC 100-240V 50/60Hz
Hardware Version	1.2
Software Version	2024.10.139.200_Drv_3.00.0044.L

# TEST REPORT

Report No.: SHE23100101-01DE

Date: 2024-05-30

Page 4 of 36

## RF power setting in TEST SW

Bluetooth RF Test Tool (RtlBluetooth MP.dll Version: 5.3.62 RTLBTAPP Version: 5.2.2.99) Power level setting Default

### Note:

1. The above information was declared by the manufacture.
2. For more details, please refer to the User's manual of the EUT.

## Channel List

Channel	Frequency	Channel	Frequency	Channel	Frequency
0	2.402GHz	14	2.430GHz	28	2.458GHz
1	2.404GHz	15	2.432GHz	29	2.460GHz
2	2.406GHz	16	2.434GHz	30	2.462GHz
3	2.408GHz	17	2.436GHz	31	2.464GHz
4	2.410GHz	18	2.438GHz	32	2.466GHz
5	2.412GHz	19	2.440GHz	33	2.468GHz
6	2.414GHz	20	2.442GHz	34	2.470GHz
7	2.416GHz	21	2.444GHz	35	2.472GHz
8	2.418GHz	22	2.446GHz	36	2.474GHz
9	2.420GHz	23	2.448GHz	37	2.476GHz
10	2.422GHz	24	2.450GHz	38	2.478GHz
11	2.424GHz	25	2.452GHz	39	2.480GHz
12	2.426GHz	26	2.454GHz		
13	2.428GHz	27	2.456GHz		

## 1.4 Test Methodology

47 CFR Part 15, Subpart C	Telecommunication-Radio Frequency Devices-Intentional Radiators
KDB Publication 558074 D01 v05r02	15.247 Meas Guidance.
ANSI C63.10-2013	American National Standard for Testing Unlicensed Wireless Devices

### Note(s):

All test items were verified and recorded according to the standards and without any addition/deviation/exclusion during the test.

# TEST REPORT

Report No.: SHE23100101-01DE

Date: 2024-05-30

Page 5 of 36

## 1.5 Test Summary

Test Item	FCC Rules	Result
Antenna Requirement	FCC Part 15.247(b)(4), Part 15.203	PASS
Maximum peak conducted output power	FCC Part 15.247(b)(3)	PASS
6dB Bandwidth and 99% Bandwidth	FCC Part 15.247(a)(2)	PASS
Maximum conducted output power spectral density	FCC Part 15.247(e)	PASS
Conducted Spurious Emission & Authorized-band band-edge	FCC Part 15.247(d)	PASS
Radiated Emission	FCC Part 15.247(d), 15.205, 15.209	PASS
Band Edge (Restricted-band band-edge)	FCC Part 15.247(d), 15.205, 15.209	PASS
Conducted Emission on AC Mains	FCC Part 15.207(a)	PASS

# TEST REPORT

Report No.: SHE23100101-01DE

Date: 2024-05-30

Page 6 of 36

## 2 Test Condition

### 2.1 Environmental conditions

Temperature (°C)	18-25
Humidity (%RH)	40-65
Barometric Pressure (mbar)	960-1060

### 2.2 Equipment List

Name of Equipment	Manufacturer	Model	Serial No.	Cal. Date	Cal. Due
Spectrum Analyzer	Keysight	N9020B	MY59260184	2023-07-27	2024-07-26
Spectrum Analyzer	Rohde & Schwarz	FSV40N	101450	2023-06-08	2024-06-07
Signal Generator	Rohde & Schwarz	SMR27	100184	2023-07-27	2024-07-26
EMI Test Receiver	Rohde & Schwarz	ESPI3	100173	2023-06-08	2024-06-07
EMI Test Receiver	Rohde & Schwarz	ESR 7	101911	2023-06-08	2024-06-07
V-network	SCHWARZBECK	NSLK 8127	8127-902	2023-06-07	2024-06-06
Attenuator	SCHWARZBECK	VTSD 9561-FN	/	2023-06-06	2024-06-05
Broadband Antenna	SCHWARZBECK	VULB9163	9163-1037	2023-03-22	2025-03-21
Horn Antenna-18G	SCHWARZBECK	BBHA9120D	9120D-1775	2023-06-13	2025-06-12
Loop Antenna	SCHWARZBECK	FMZB 1513	/	2023-06-09	2024-06-08
Horn Antenna-40G	YINGLIAN	LB-180400-KF	N/A	2023-06-18	2025-06-17
Broadband Preamplifier	SCHWARZBECK	BBV 9718	346	2023-06-08	2024-06-07
EMC chamber 9*6*6(L*W*H)	CHANGNING	966	N/A	2023-06-09	2025-06-08
Shielded Enclosure 8*5*4(L*W*H)	CHANGNING	854	N/A	2023-06-09	2025-06-08
Test Software	BL	BL410_E	Version:1.0.0.117	N/A	N/A
Test Software	BL	BL410_R	Version:2.1.1.409	N/A	N/A

# TEST REPORT

Report No.: SHE23100101-01DE

Date: 2024-05-30

Page 7 of 36

## 2.3 Measurement Uncertainty

The uncertainty is calculated using the methods suggested in the “Guide to the Expression of Uncertainty in measurement” (GUM) published by CISPR and ANSI. The reported uncertainty of measurement  $y \pm U$ , where expanded uncertainty  $U$  is based on a standard uncertainty multiplied by a coverage factor of  $k=2$ , providing a level of confidence of approximately 95.45%.

Parameter		Uncertainty
Antenna Port Conducted Emission	< 1GHz	$\pm 1.5$ dB
	> 1GHz	$\pm 1.5$ dB
Radiated Emission	9KHz – 30MHz	$\pm 3.42$ dB
	30 MHz – 1GHz	$\pm 5.01$ dB
	> 1GHz	$\pm 5.21$ dB
Conducted Emission on AC Mains	150kHz-30MHz	$\pm 2.68$ dB
Occupied Channel Bandwidth		$\pm 5$ %
Maximum Conducted Output Power		$\pm 0.64$ dB
Maximum Conducted Output Power Spectral Density		$\pm 1.18$ dB

# TEST REPORT

Report No.: SHE23100101-01DE

Date: 2024-05-30

Page 8 of 36

## 3 Test Set-up and Operation Modes

### 3.1 Details of Test Mode

Using test software was control EUT work in continuous transmitting mode. Select test channel as below:

Channel	Frequency
The lowest channel(CH00)	2402MHz
The middle channel(CH19)	2440MHz
The Highest channel(CH39)	2480MHz

The basic operation modes are:

- A. On
  - 1. BLE mode
    - a. Transmitting
      - i. Low Channel
      - ii. Middle Channel
      - iii. High Channel
    - b. Receiving
  - 2. Normal working with Bluetooth on
- B. Standby
- C. Off

### 3.2 Special Accessories and Auxiliary Equipment

Description	Manufacturer	Model Name	Serial No.
AC/DC ADAPTER	Guangdong Mingxin Power Technologies Co., Ltd	MX120Z-19006300	MX120Z19006300
Mouse	Dell	MS116t1	CN-065K5F-LO300-248-0VP2
Keyboard	Dell	KB216P	CN-0M4W71-73826-6C801SQ-A02

### 3.3 Support Software

Description	Manufacturer	Software Name
Software	N/A	Realtek 11ac 8821C PCIE WLAN MP Diagnostic Program 0.0007.00.20190801



# TEST REPORT

Report No.: SHE23100101-01DE

Date: 2024-05-30

Page 9 of 36

## 3.4 Test Setup Diagram

Diagram of Measurement Configuration for Radiation Test

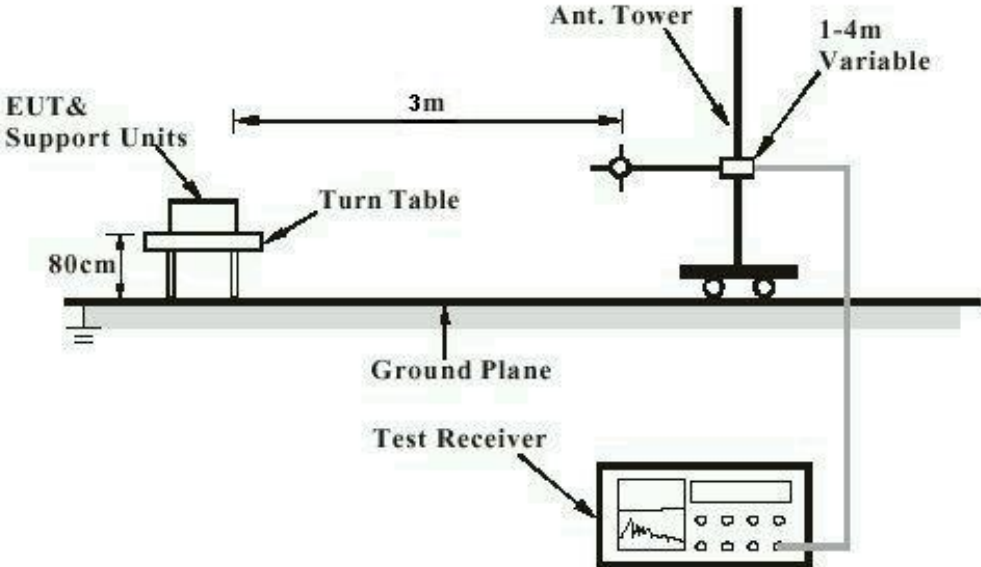

Note: Measurements above 1GHz are done with a table height of 1.5m. In addition, there is RF absorbing material on the floor of the test site for above 1GHz measurement.

Diagram of Measurement Equipment Configuration for Conduction Measurement

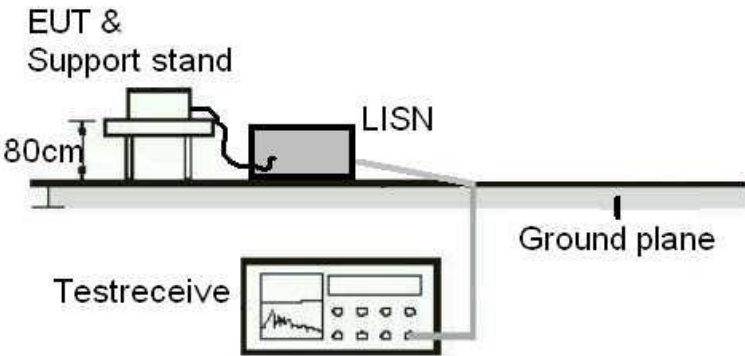

# TEST REPORT

Report No.: SHE23100101-01DE

Date: 2024-05-30

Page 10 of 36

## Diagram of Measurement Equipment Configuration for Transmitter Test

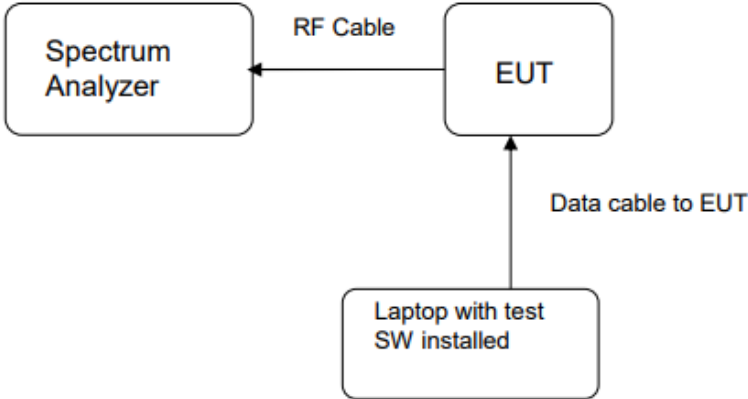

# TEST REPORT

Report No.: SHE23100101-01DE

Date: 2024-05-30

Page 11 of 36

## 4 Test Results

### 4.1 Transmitter Requirement & Test Suites

#### 4.1.1 Antenna Requirement

RESULT:

**PASS**

Test standard : FCC Part 15.247(b)(4), Part 15.203  
Requirement : An intentional radiator shall be designed to ensure that no antenna other than that furnished by the responsible party shall be used with the device. The use of a permanently attached antenna or of an antenna that uses a unique coupling to the intentional radiator shall be considered sufficient to comply with the provisions of this section. The manufacturer may design the unit so that a broken antenna can be replaced by the user, but the use of a standard antenna jack or electrical connector is prohibited. In addition, If transmitting antennas of directional gain greater than 6dBi are used, both the maximum conducted output power and the maximum power spectral density shall be reduced by the amount in dB that the directional gain of the antenna exceeds 6dBi.

According to the manufacturer declaration, the EUT has an antenna with a directional gain of 1.83dBi. The antenna is an internal antenna with no possibility of replacement with a non-approved antenna by the end-user.

Therefore, the EUT is considered to comply with this provision.

# TEST REPORT

Report No.: SHE23100101-01DE

Date: 2024-05-30

Page 12 of 36

## 4.1.2 Maximum peak conducted output power

RESULT:

PASS

Test standard : FCC Part 15.247(b)(3)  
 Requirement : ANSI C63.10-2013 clause 11.9.1.1,  
 KDB 558074 D01 v05r02, Clause 8.3.1  
 Kind of test site : Shielded room

### Test setup

Test Channel : Low/Middle/High  
 Operation Mode : A.1.a  
 Ambient temperature : 24.9°C  
 Relative humidity : 56%

Table 1: Maximum peak conducted output power

Test Mode	Test Channel (MHz)	Maximum peak conducted output power		Limit (W)
		(dBm)	(mW)	
BLE	2402	-5.80	0.26	< 1
	2440	-2.85	0.52	
	2480	-0.19	0.96	

Figure 1: Peak Output Power, 2402MHz

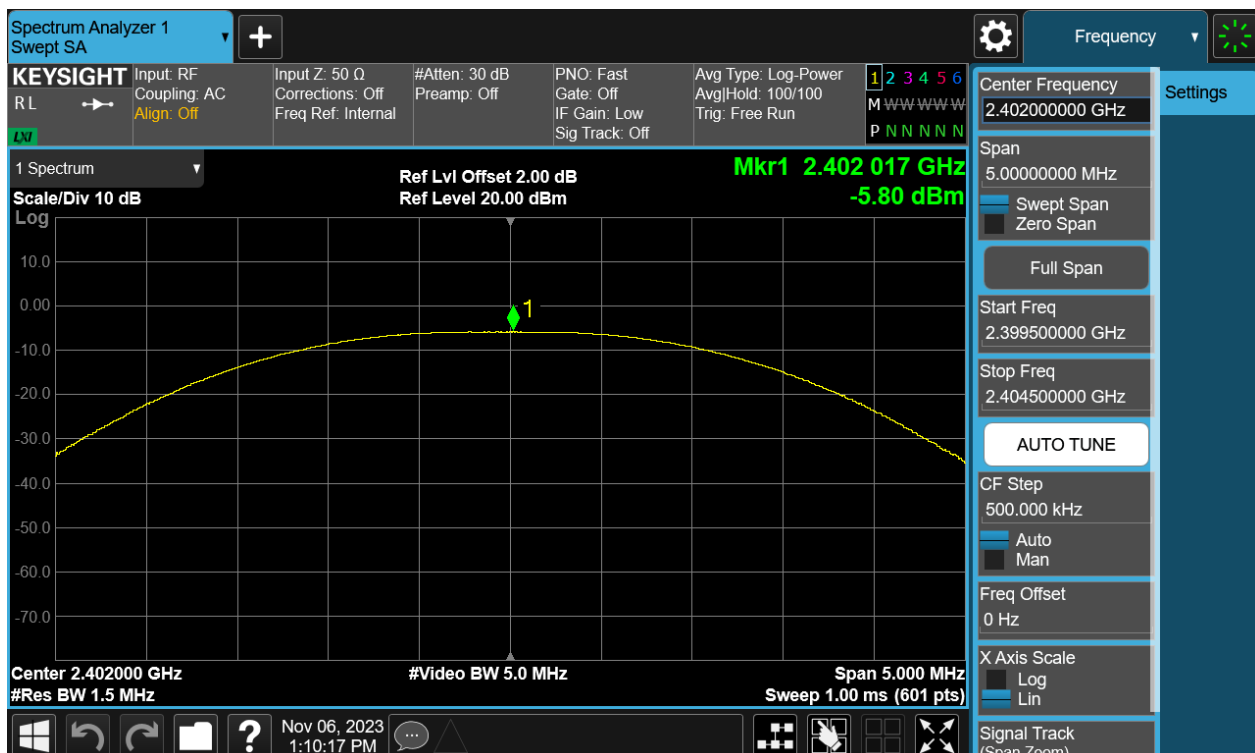

# TEST REPORT

Report No.:

SHE23100101-01DE

Date:

2024-05-30

Page 13 of 36

Figure 2: Peak Output Power, 2440MHz

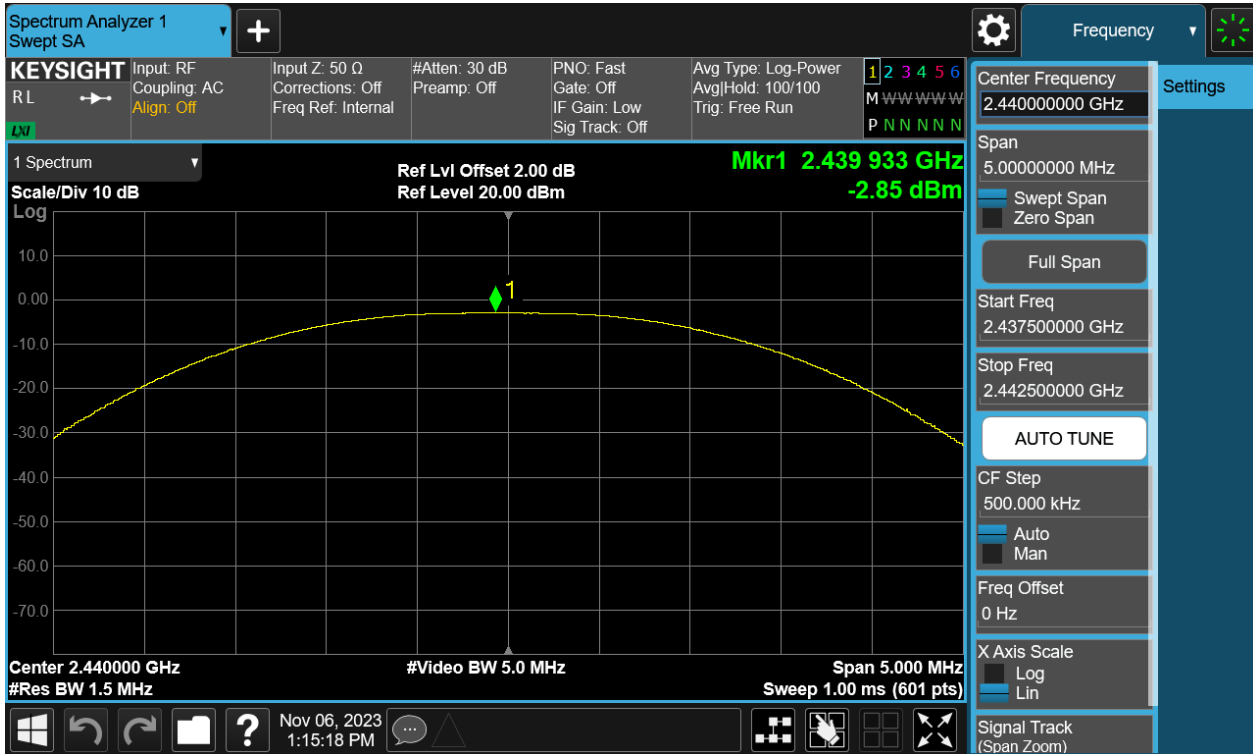
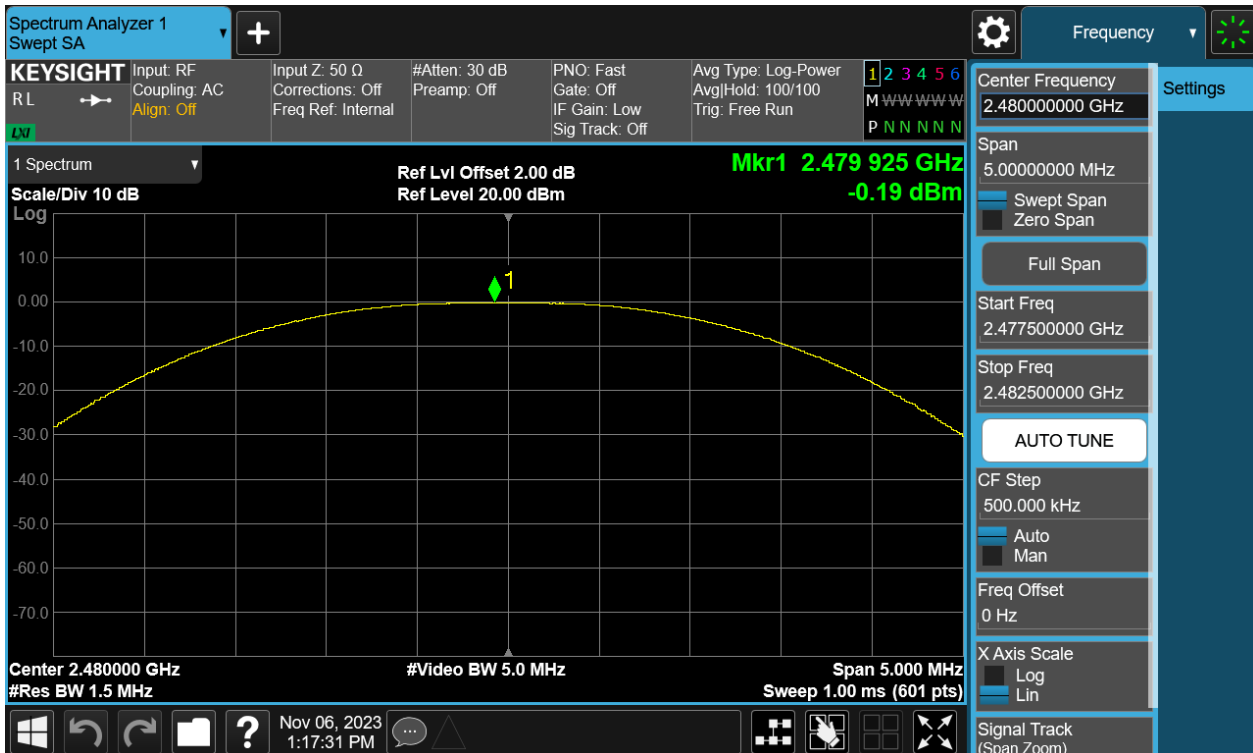

Figure 3: Peak Output Power, 2480MHz



# TEST REPORT

Report No.: SHE23100101-01DE

Date: 2024-05-30

Page 14 of 36

## 4.1.3 6dB Bandwidth and 99% Bandwidth

RESULT:

PASS

Test standard : FCC Part 15.247(a)(2)  
Requirement : ANSI C63.10-2013 clause 11.8.1,  
KDB 558074 D01 v05r02, Clause 8.2  
Kind of test site : Shielded room

### Test setup

Test Channel : Low/Middle/High  
Operation Mode : A.1.a  
Ambient temperature : 21.3°C  
Relative humidity : 42%

Table 2: 6dB Bandwidth and 99% Bandwidth

Test Mode	Test Channel (MHz)	6dB Bandwidth (MHz)	99% Bandwidth (MHz)	6dB Bandwidth Limit
BLE	2402	0.6908	1.0504	≥0.5 MHz
	2440	0.7431	1.0466	
	2480	0.6895	1.0496	

# TEST REPORT

Report No.: SHE23100101-01DE

Date: 2024-05-30

Page 15 of 36

Figure 4: 6dB Bandwidth, 2402MHz



99% Bandwidth, 2402MHz

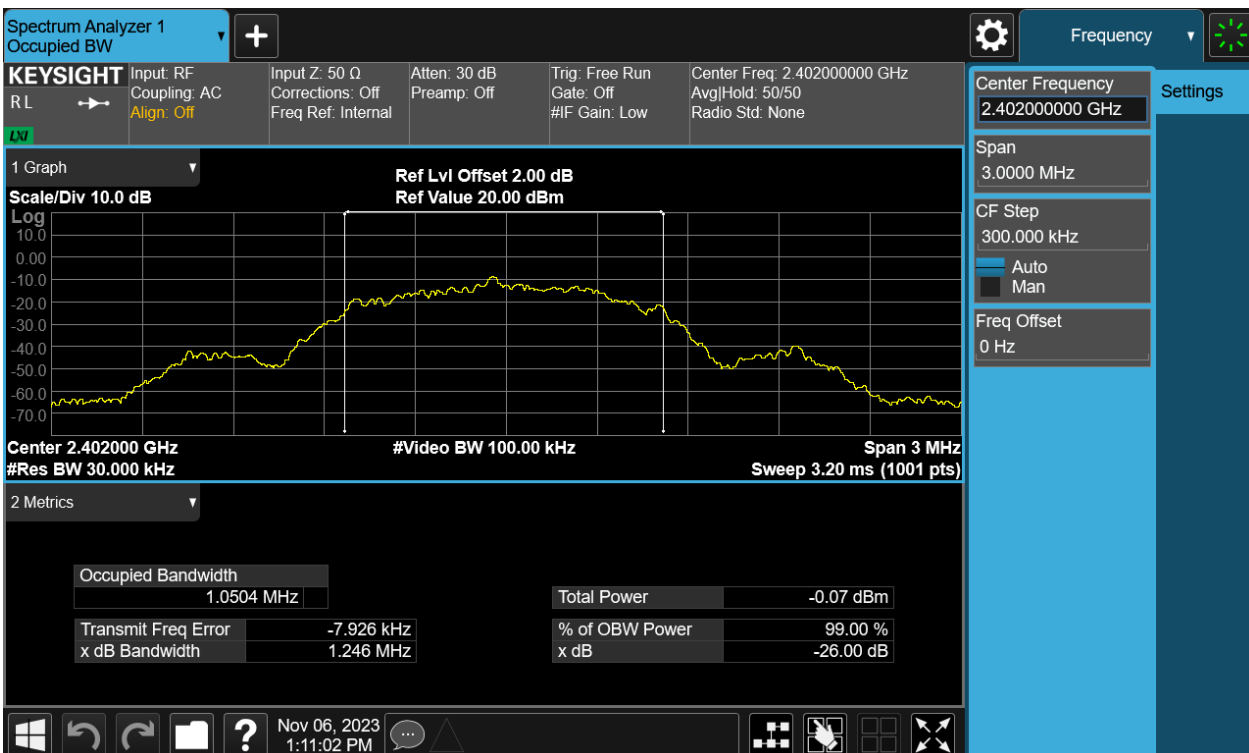

# TEST REPORT

Report No.: SHE23100101-01DE

Date: 2024-05-30

Page 16 of 36

Figure 5: 6dB Bandwidth, 2440MHz



99% Bandwidth, 2440MHz





# TEST REPORT

Report No.: SHE23100101-01DE

Date: 2024-05-30

Page 17 of 36

Figure 6: 6dB Bandwidth, 2480MHz



99% Bandwidth, 2480MHz

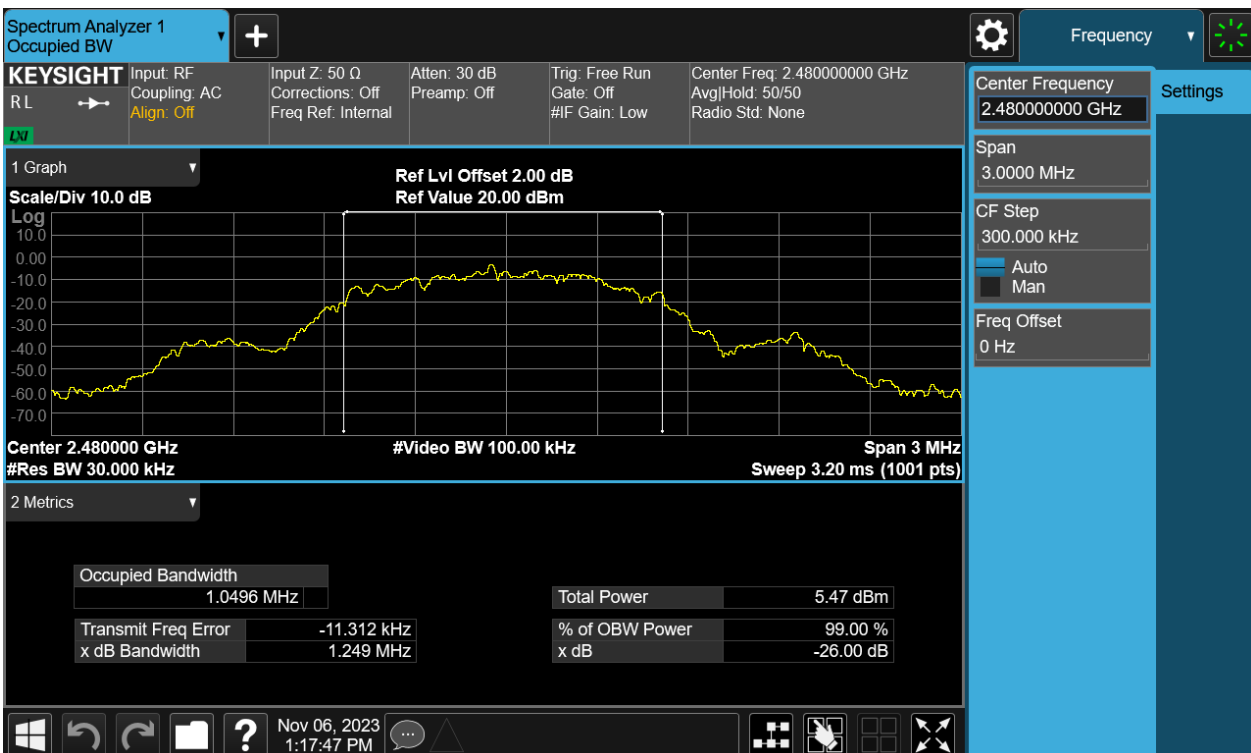

# TEST REPORT

Report No.: SHE23100101-01DE

Date: 2024-05-30

Page 18 of 36

## 4.1.4 Maximum conducted output power spectral density

RESULT:

PASS

Test standard : FCC Part 15.247(e)  
 Requirement : ANSI C63.10-2013 clause 11.10.2,  
 KDB 558074 D01 v05r02, Clause 8.4  
 Kind of test site : Shielded room

### Test setup

Test Channel : Low/Middle/High  
 Operation Mode : A.1.a  
 Ambient temperature : 21.3°C  
 Relative humidity : 42%

Table 3: Maximum conducted output power spectral density

Test Mode	Test Channel (MHz)	Measured Result (dBm/3kHz)	Limit (dBm/3kHz)
BLE	2402	-21.49	8
	2440	-18.84	
	2480	-15.81	

Figure 7: Power Spectral Density, 2402MHz

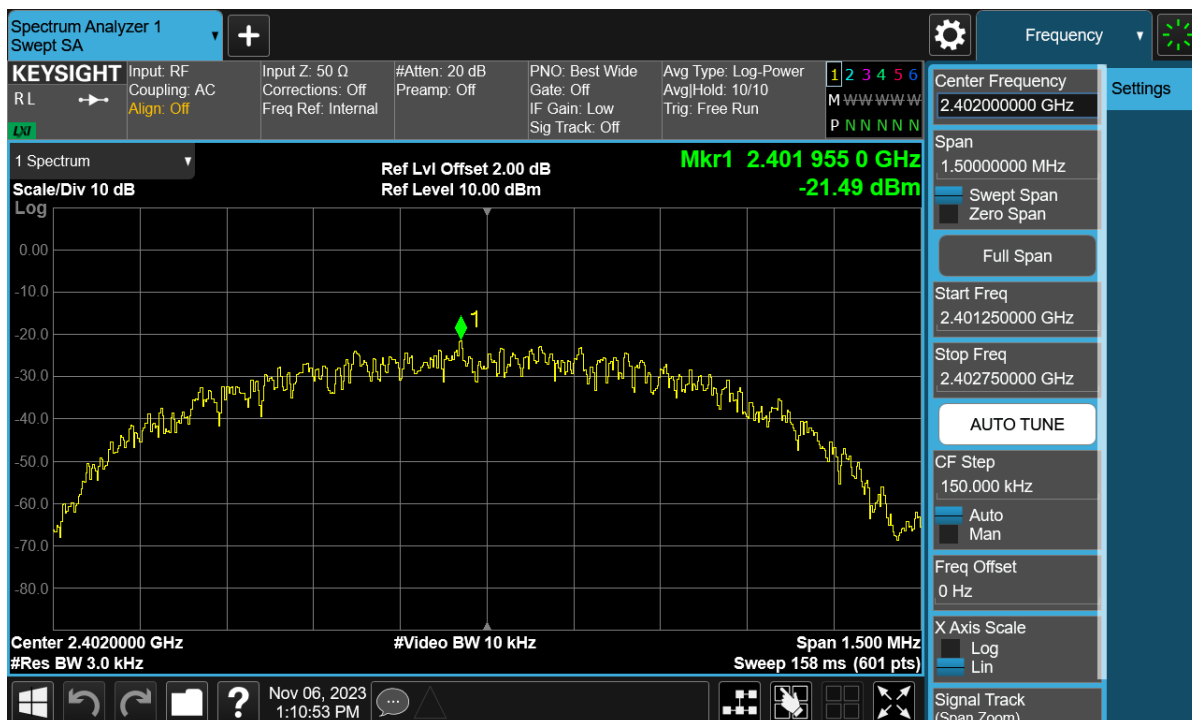

# TEST REPORT

Report No.:

SHE23100101-01DE

Date:

2024-05-30

Page 19 of 36

Figure 8: Power Spectral Density, 2440MHz

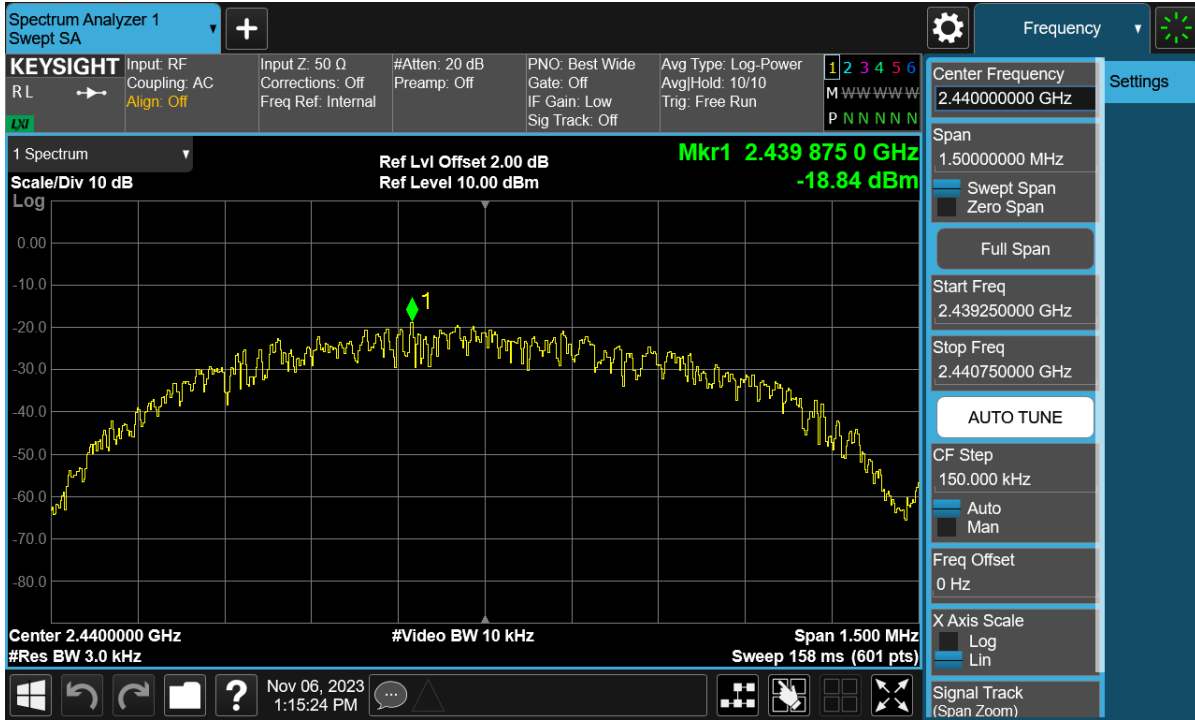
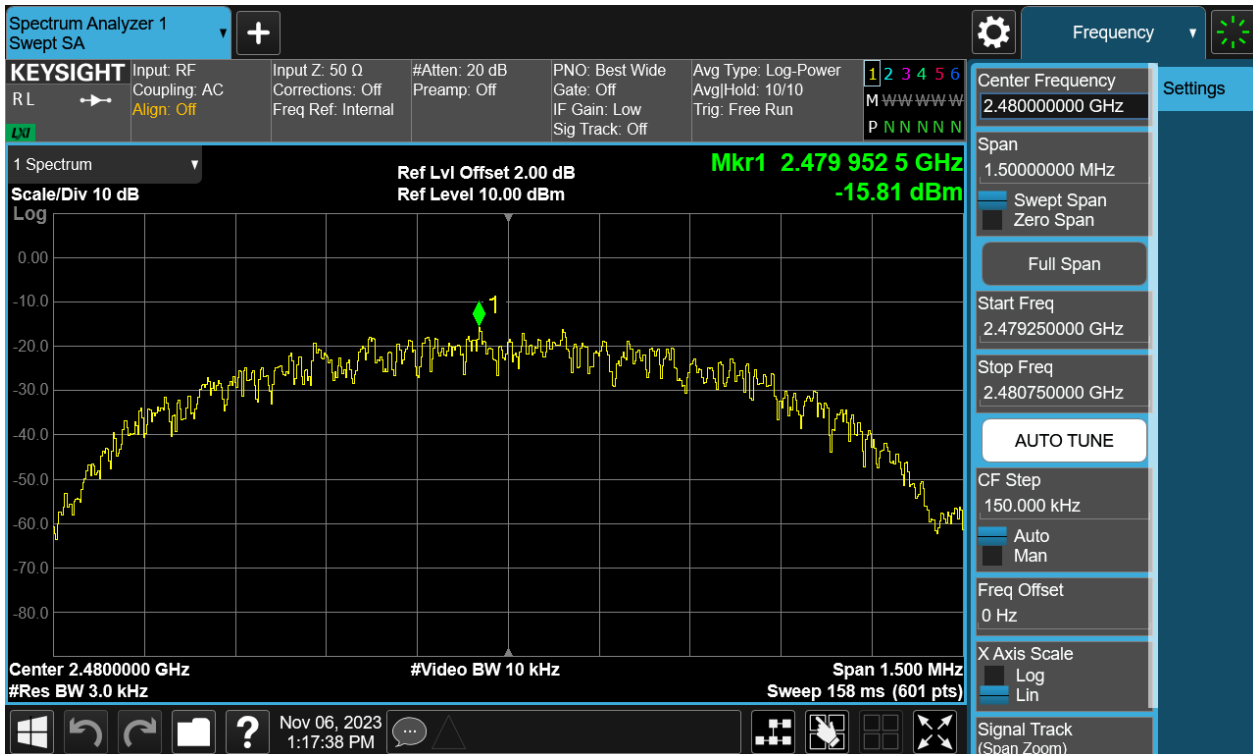

Figure 9: Power Spectral Density, 2480MHz



# TEST REPORT

Report No.: SHE23100101-01DE

Date: 2024-05-30

Page 20 of 36

## 4.1.5 Conducted Spurious Emission & Authorized-band band-edge

RESULT:

**PASS**

Test standard : FCC Part 15.247(d)  
Requirement : ANSI C63.10-2013, Clause 11.11.1(a)  
KDB 558074 D01 v05r02, Clause 8.5  
Kind of test site : Shielded room

### Test setup

Test Channel : Low/Middle/High for spurious, Low/High for Band  
Edge  
Operation Mode : A.1.a  
Ambient temperature : 21.3°C  
Relative humidity : 42%

For details refer to following test plot.

# TEST REPORT

Report No.:

SHE23100101-01DE

Date:

2024-05-30

Page 21 of 36

Figure 10: Conducted Spurious Emission & Authorized-band band-edge, 2402MHz, BLE Carrier Level

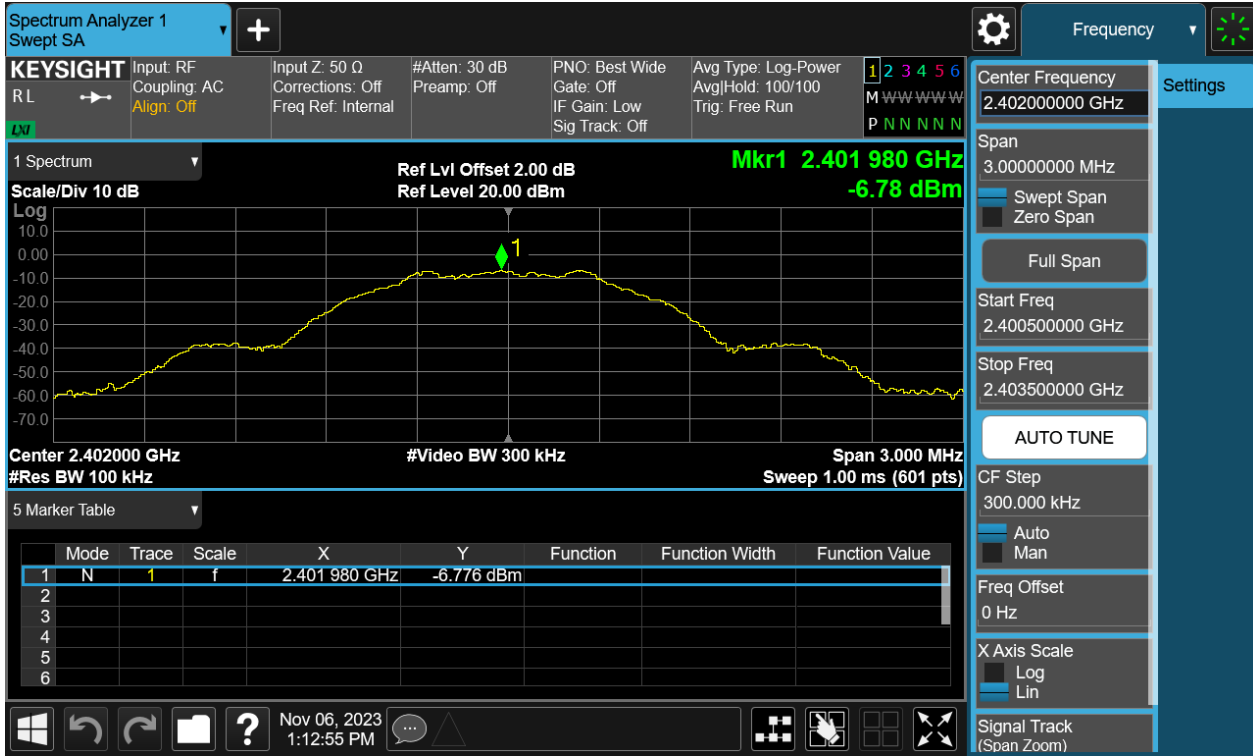

## Band Edge

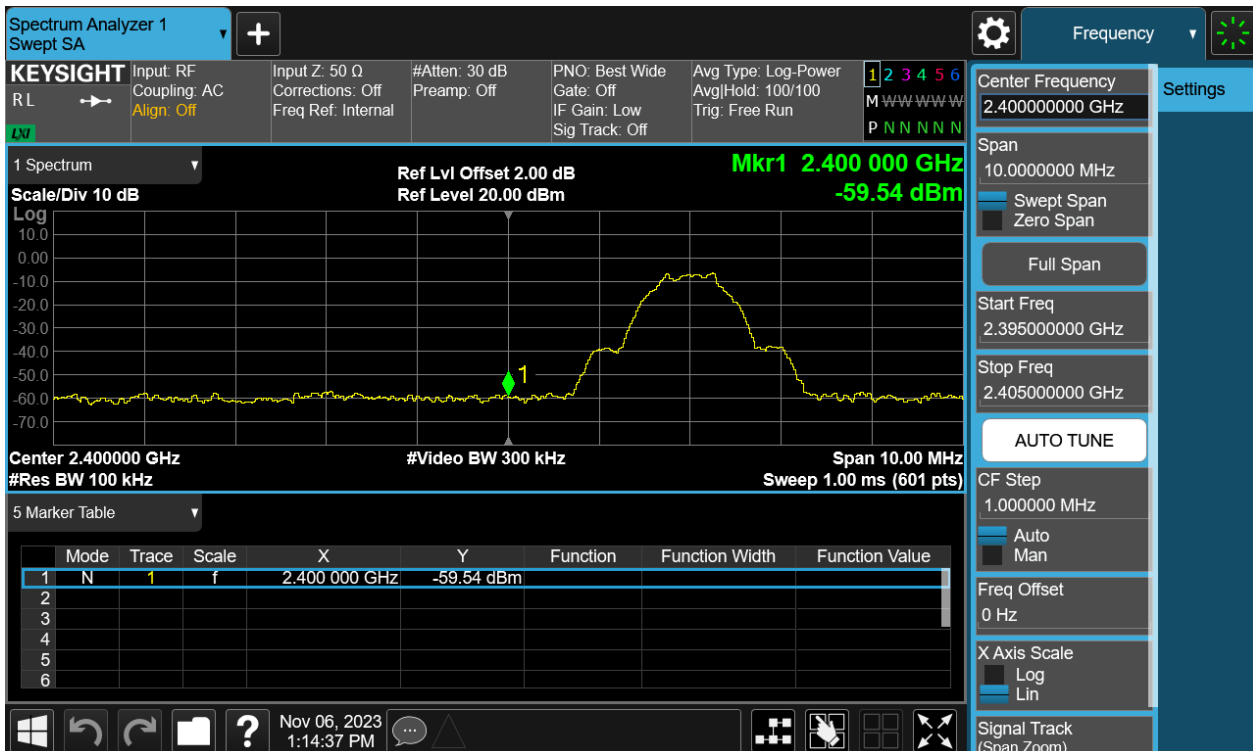

# TEST REPORT

Report No.: SHE23100101-01DE

Date: 2024-05-30

Page 22 of 36

## Conducted spurious emissions 30MHz-25GHz

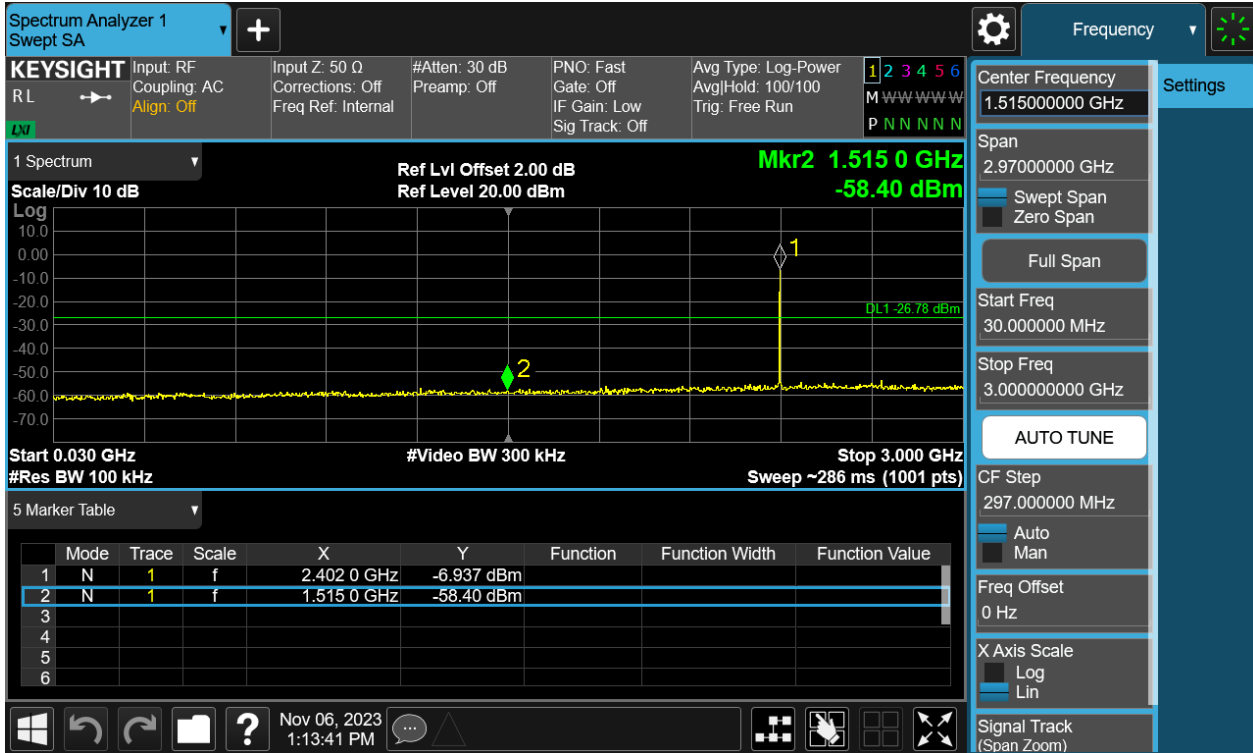

# TEST REPORT

Report No.: SHE23100101-01DE

Date: 2024-05-30

Page 23 of 36

Figure 11: Conducted Spurious Emission & Authorized-band band-edge, 2440MHz, BLE Carrier Level

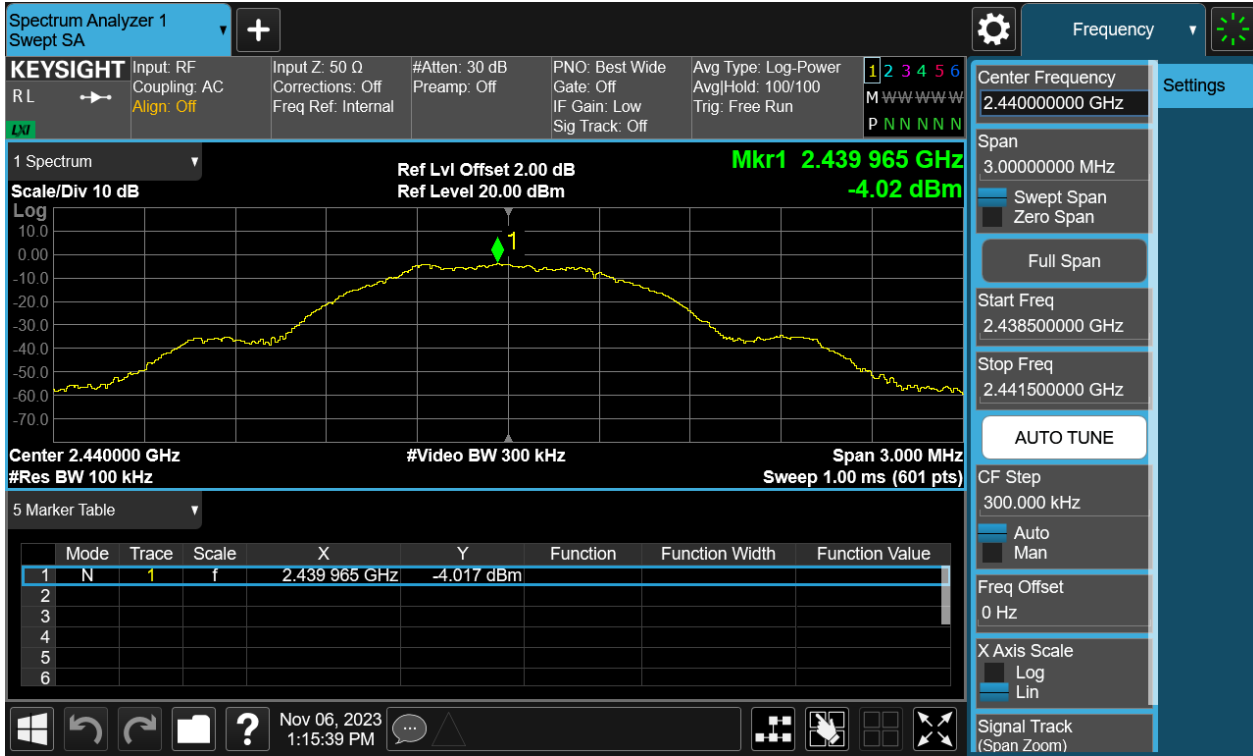

Conducted spurious emissions 30MHz-25GHz

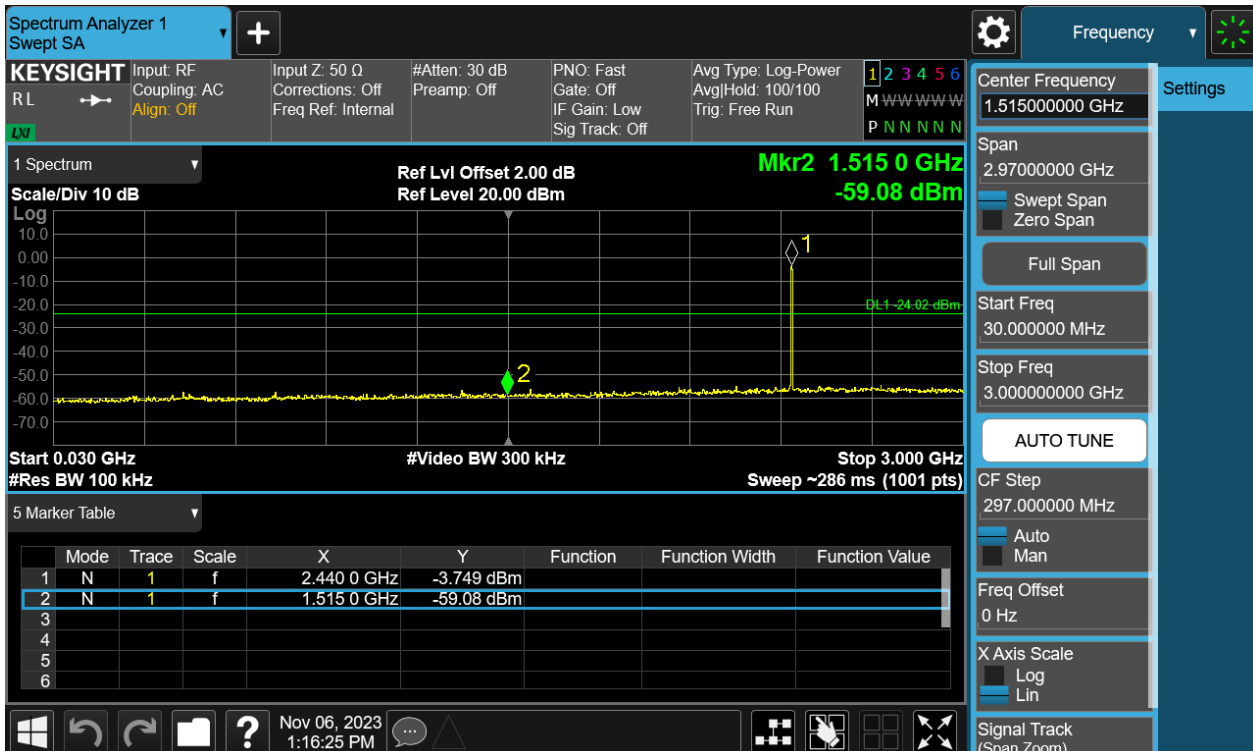

# TEST REPORT

Report No.:

SHE23100101-01DE

Date:

2024-05-30

Page 24 of 36

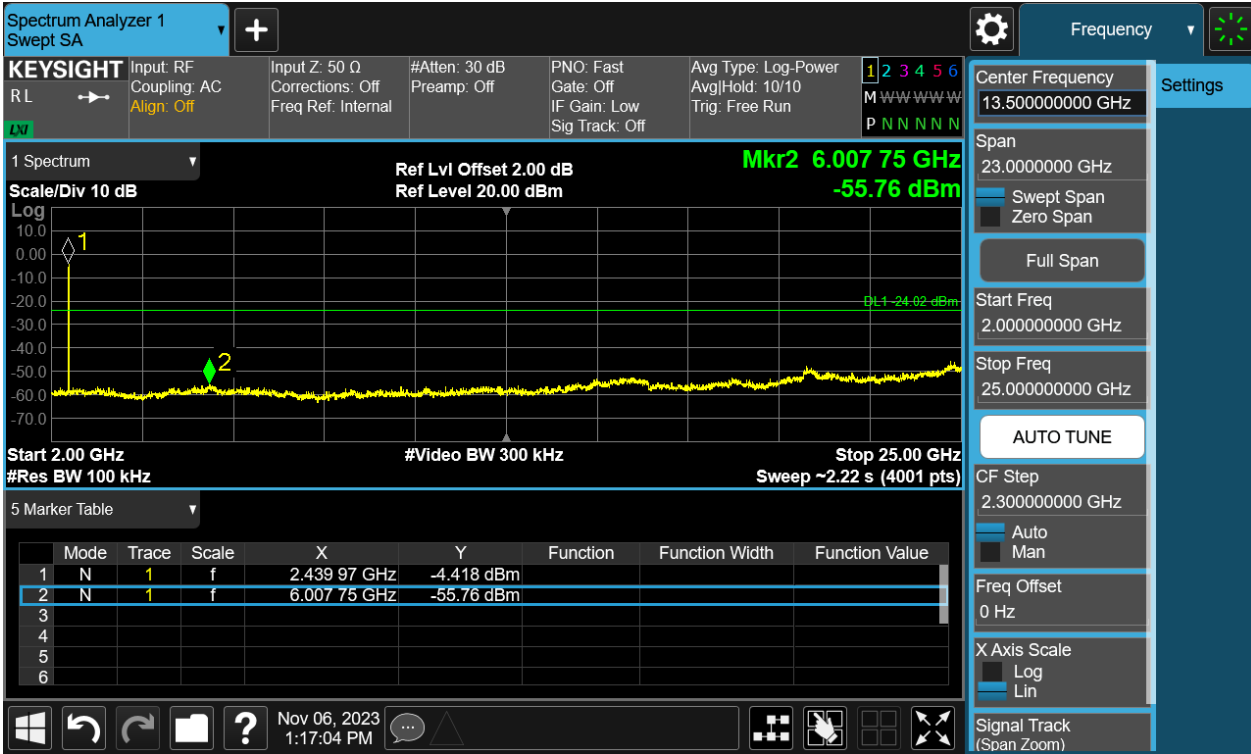
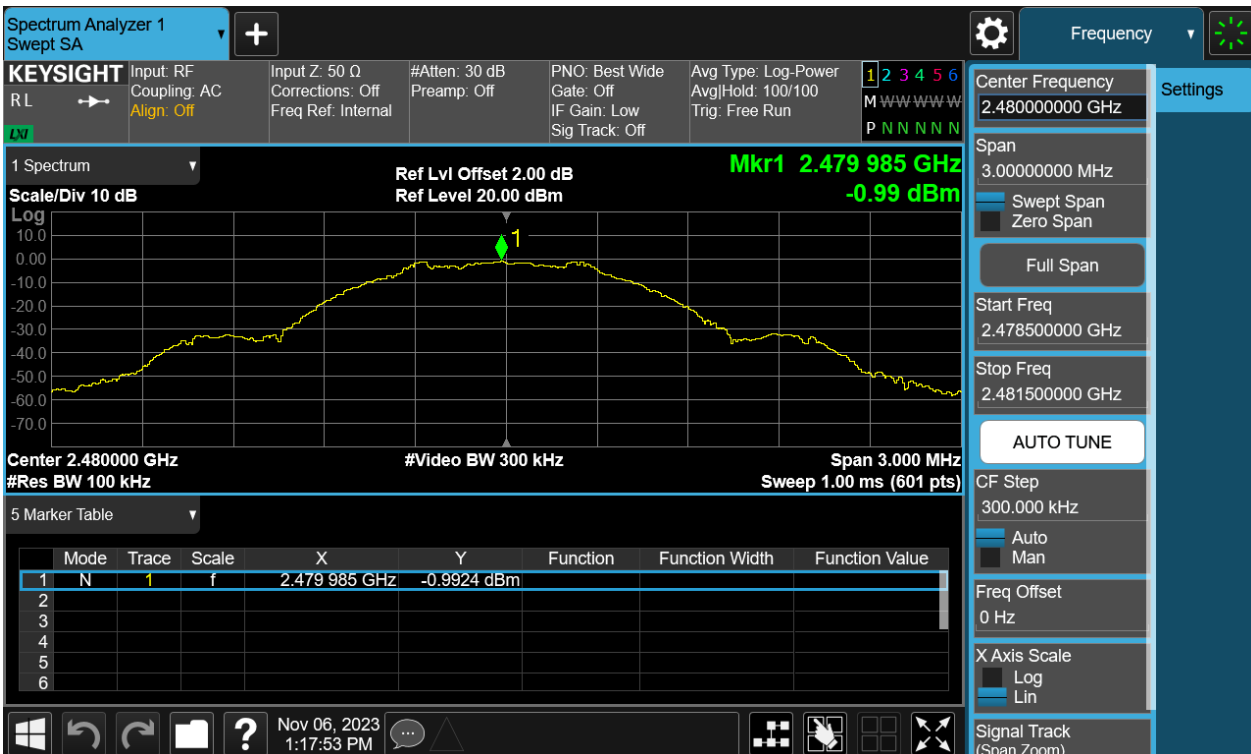

Figure 12: Conducted Spurious Emission & Authorized-band band-edge, 2480MHz, BLE Carrier Level





# TEST REPORT

Report No.:

SHE23100101-01DE

Date:

2024-05-30

Page 25 of 36

## Band Edge



## Conducted spurious emissions 30MHz-25GHz

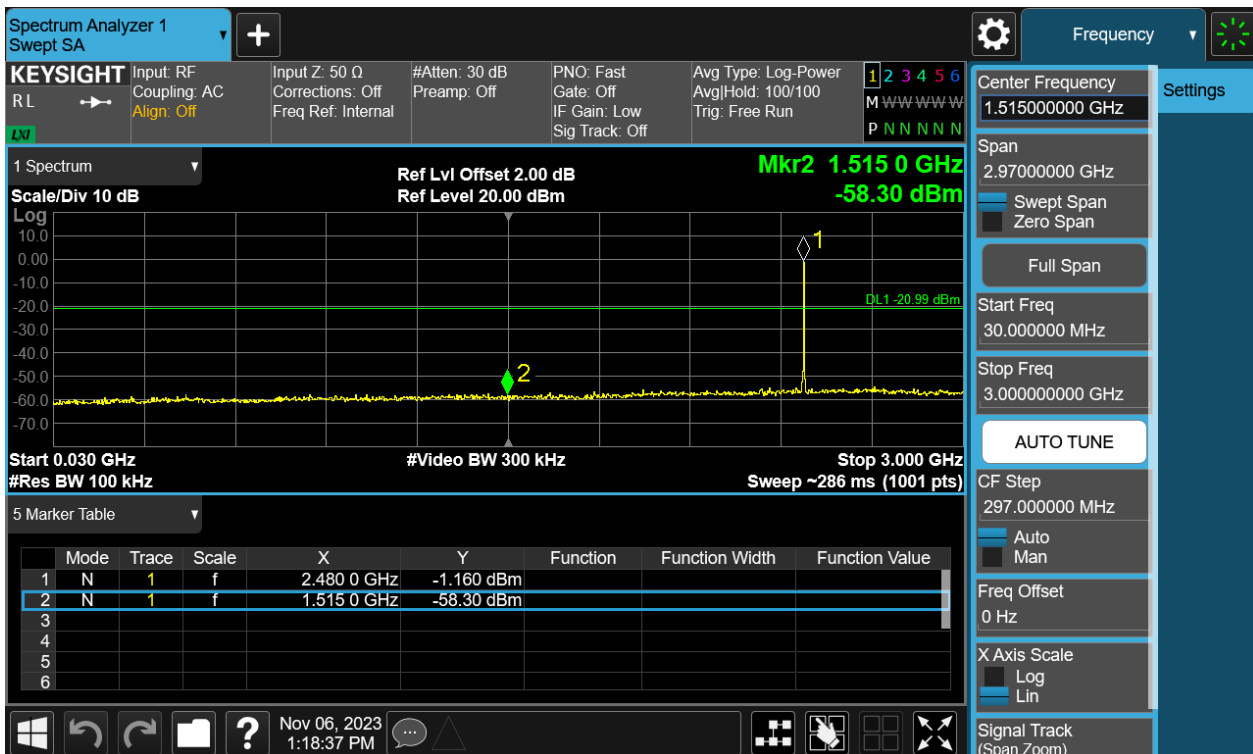

# TEST REPORT

Report No.:

SHE23100101-01DE

Date:

2024-05-30

Page 26 of 36

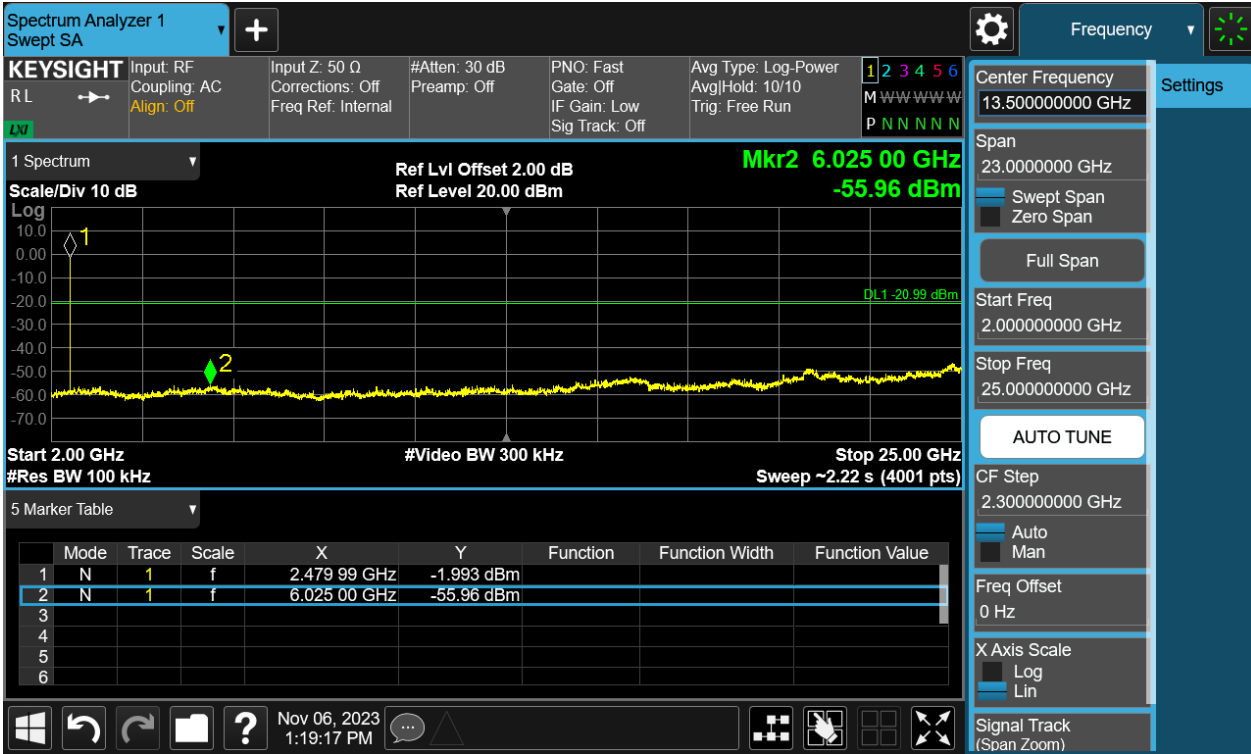

# TEST REPORT

Report No.: SHE23100101-01DE

Date: 2024-05-30

Page 27 of 36

## 4.1.6 Radiated Emission

RESULT:

**PASS**

Test standard : FCC Part 15.247(d), 15.205, 15.209  
Requirement : ANSI C63.10-2013 clause 11.12,  
KDB 558074 D01 v05r02, Clause 8.6  
Kind of test site : 3m Semi-Anechoic Chamber

### Test setup

Test Channel : Low/Middle/High  
Operation Mode : A  
Ambient temperature : 25.1°C  
Relative humidity : 52%

### Notes

*Test plots please refer to the annex document "SHE23100101-01DE DATA BLE-TX EXHIBIT A".*

1. For 9 kHz ~ 30 MHz, the amplitude of spurious emissions that are attenuated by more than 20dB below the permissible. The value has no need to be reported. In addition, During 30MHz to 1GHz test frequency range, only the worst mode data was reported in this report.
2. The spurious above 18GHz is noise only and 20dB below the limit. The value has no need to be reported.
3. The EUT was pretested with 3 orientations placed on the table for the radiated emission measurement -X, Y, and Z-plane. The X-plane results were found as the worst case and were shown in this report.

# TEST REPORT

Report No.: SHE23100101-01DE

Date: 2024-05-30

Page 28 of 36

## 4.1.7 Band Edge (Restricted-band band-edge)

RESULT:

**PASS**

Test standard : FCC Part 15.247(d), 15.205, 15.209  
Requirement : ANSI C63.10-2013 clause 11.13,  
KDB 558074 D01 v05r02, Clause 8.7  
Kind of test site : 3m Semi-Anechoic Chamber

### Test setup

Test Channel : Low/Middle/High  
Operation Mode : A.1  
Ambient temperature : 25.1°C  
Relative humidity : 52%

### Notes

*Test plots please refer to the annex document "SHE23100101-01DE DATA BLE-TX EXHIBIT A".*

# TEST REPORT

Report No.: SHE23100101-01DE

Date: 2024-05-30

Page 29 of 36

## 4.2 Mains Emissions

### 4.2.1 Conducted Emission on AC Mains

RESULT:

**PASS**

Test standard : FCC Part 15.207(a)  
Requirement : ANSI C63.10-2013, Clause 6.2  
Kind of test site : Shielded room

#### Test setup

Input Voltage : which received AC 120V, 60Hz Power  
Operation Mode : A.1.a  
Earthing : Disconnected to GND  
Ambient temperature : 21°C  
Relative humidity : 50%

For details refer to following test plot.

# TEST REPORT

Report No.: SHE23100101-01DE

Date: 2024-05-30

Page 30 of 36

Note: The all configurations were tested respectively, but only the worst data (at middle channel) shown here.

**Figure 13: Conducted Emission on AC Mains, L Phase**

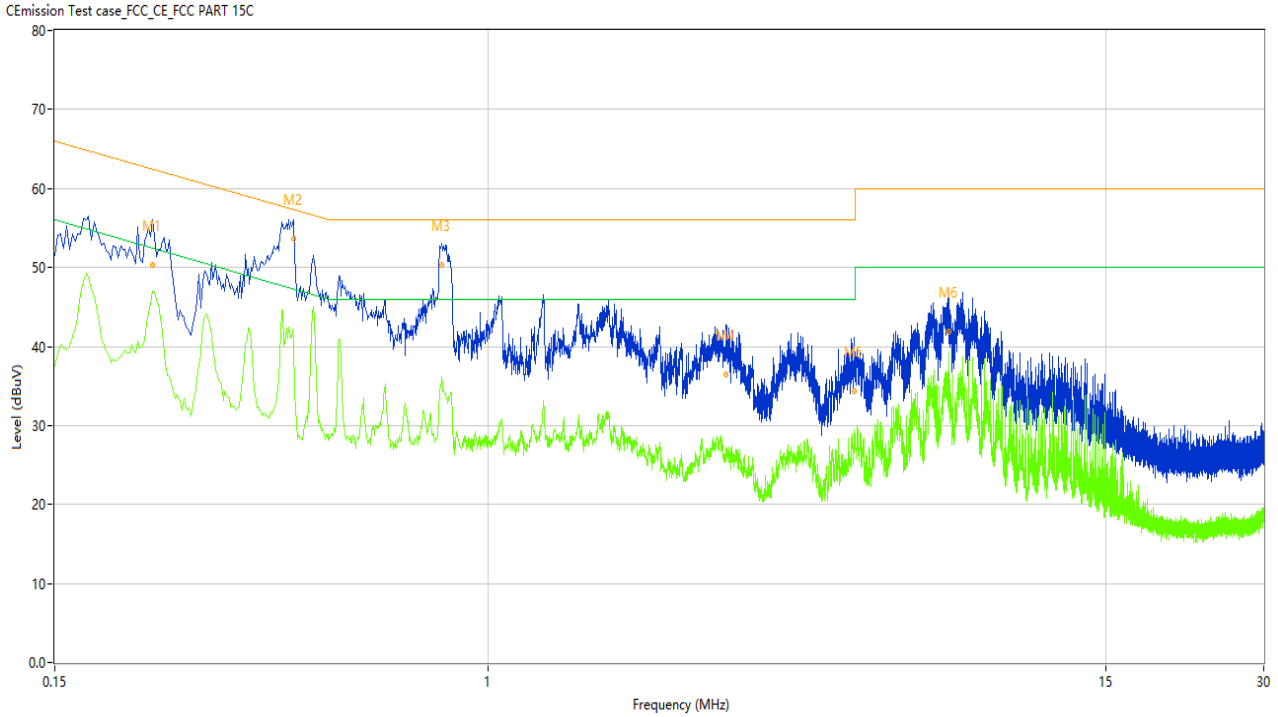

No.	Frequency (MHz)	Results (dBuV)	Factor (dB)	Limit (dBuV)	Margin (dB)	Detector	Line	Verdict
1	0.230	57.02	9.96	62.45	5.43	Peak	L	Pass
1*	0.230	50.38	9.96	62.45	12.07	QP	L	Pass
1**	0.230	46.99	9.96	52.45	5.46	AV	L	Pass
2	0.428	56.06	9.97	57.29	1.23	Peak	L	Pass
2*	0.428	53.64	9.97	57.29	3.65	QP	L	Pass
2**	0.428	40.90	9.97	47.29	6.39	AV	L	Pass
3	0.818	53.62	9.94	56.00	2.38	Peak	L	Pass
3*	0.818	50.31	9.94	56.00	5.69	QP	L	Pass
3**	0.818	36.18	9.94	46.00	9.82	AV	L	Pass
4	2.844	43.59	9.83	56.00	12.41	Peak	L	Pass
4*	2.844	36.52	9.83	56.00	19.48	QP	L	Pass
4**	2.844	27.08	9.83	46.00	18.92	AV	L	Pass
5	4.988	41.77	9.82	56.00	14.23	Peak	L	Pass
5*	4.988	34.32	9.82	56.00	21.68	QP	L	Pass
5**	4.988	27.62	9.82	46.00	18.38	AV	L	Pass
6	7.556	47.15	9.76	60.00	12.85	Peak	L	Pass
6*	7.556	41.83	9.76	60.00	18.17	QP	L	Pass
6**	7.556	39.15	9.76	50.00	10.85	AV	L	Pass

# TEST REPORT

Report No.: SHE23100101-01DE

Date: 2024-05-30

Page 31 of 36

Figure 14: Conducted Emission on AC Mains, N Phase

C:Emission Test case\_FCC\_CE\_FCC PART 15C

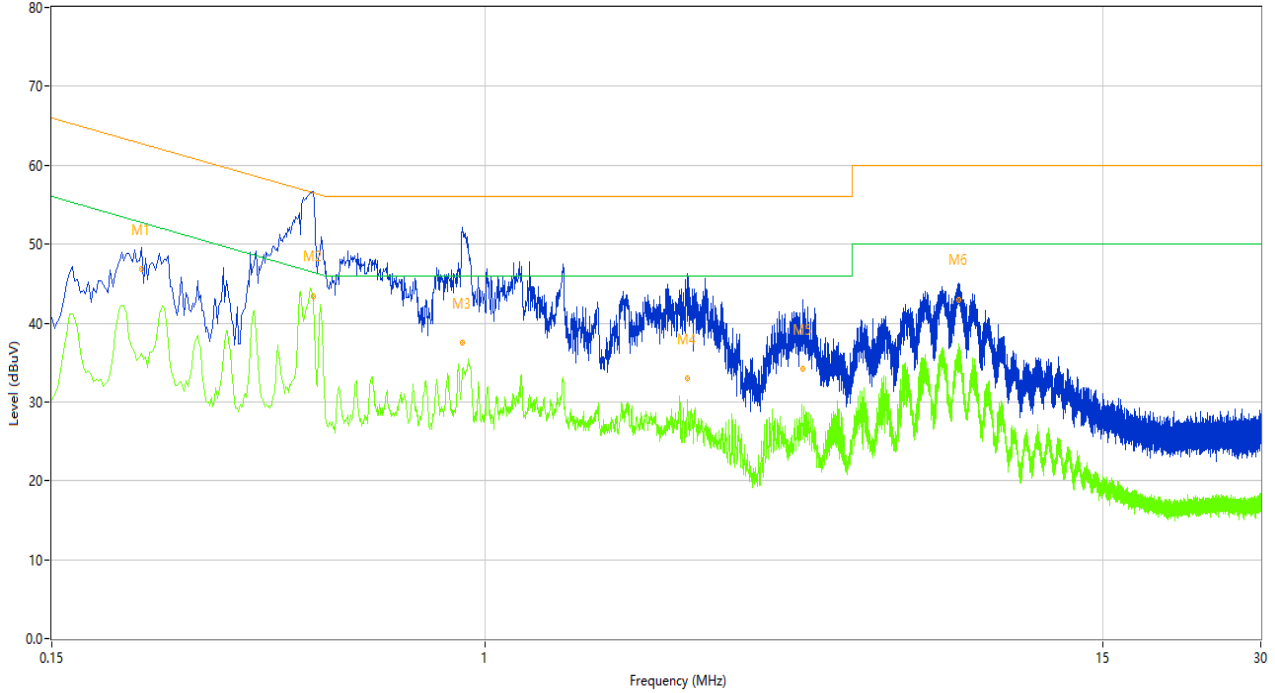

No.	Frequency (MHz)	Results (dBuV)	Factor (dB)	Limit (dBuV)	Margin (dB)	Detector	Line	Verdict
1	0.222	53.24	10.05	62.74	9.50	Peak	N	Pass
1*	0.222	46.92	10.05	62.74	15.82	QP	N	Pass
1**	0.222	36.11	10.05	52.74	16.63	AV	N	Pass
2	0.472	49.11	10.07	56.48	7.37	Peak	N	Pass
2*	0.472	43.36	10.07	56.48	13.12	QP	N	Pass
2**	0.472	42.46	10.07	46.48	4.02	AV	N	Pass
3	0.908	42.95	10.03	56.00	13.05	Peak	N	Pass
3*	0.908	37.49	10.03	56.00	18.51	QP	N	Pass
3**	0.908	33.99	10.03	46.00	12.01	AV	N	Pass
4	2.432	40.06	9.93	56.00	15.94	Peak	N	Pass
4*	2.432	33.03	9.93	56.00	22.97	QP	N	Pass
4**	2.432	30.35	9.93	46.00	15.65	AV	N	Pass
5	4.030	42.24	9.88	56.00	13.76	Peak	N	Pass
5*	4.030	34.25	9.88	56.00	21.75	QP	N	Pass
5**	4.030	26.75	9.88	46.00	19.25	AV	N	Pass
6	7.972	47.23	9.81	60.00	12.77	Peak	N	Pass
6*	7.972	43.00	9.81	60.00	17.00	QP	N	Pass
6**	7.972	37.38	9.81	50.00	12.62	AV	N	Pass

# TEST REPORT

Report No.: SHE23100101-01DE

Date: 2024-05-30

Page 32 of 36

## 5 Appendixes

### 5.1 Photographs of the Sample



Front of the sample



Rear of the sample



# TEST REPORT

Report No.:

SHE23100101-01DE

Date:

2024-05-30

Page 33 of 36

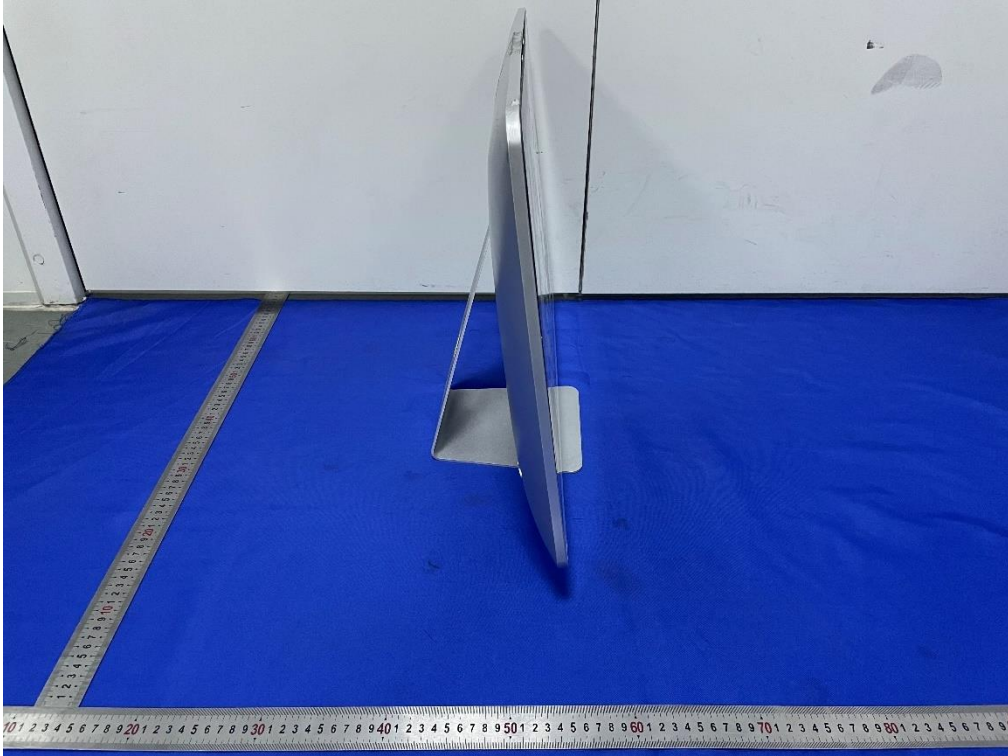

Left of the sample

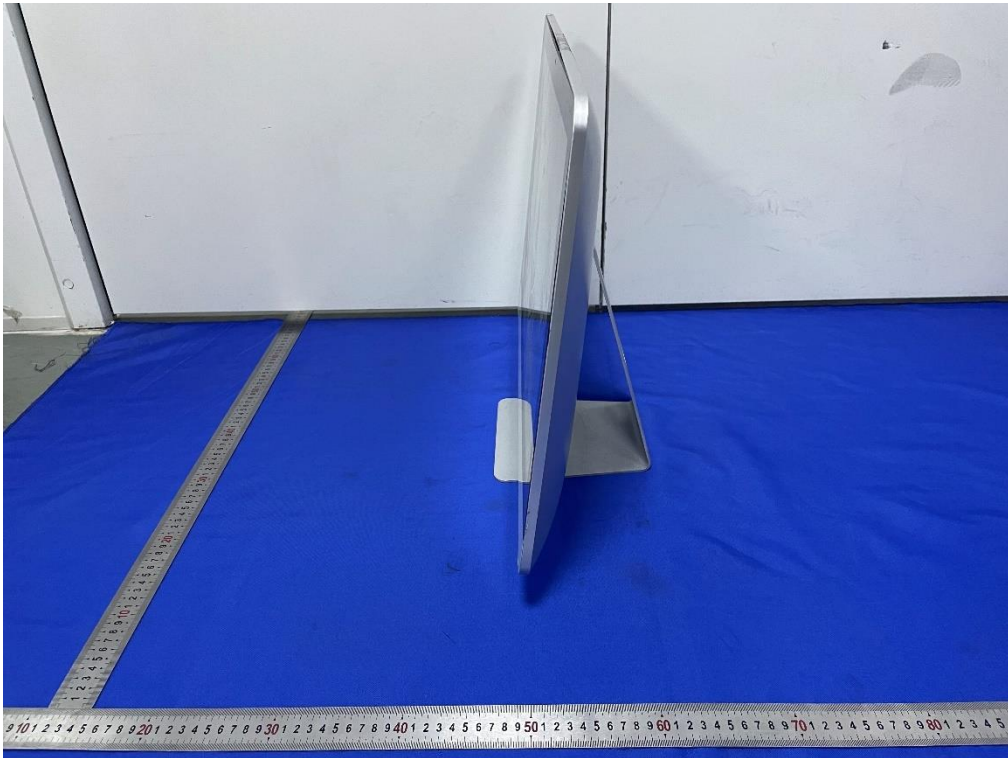

Right of the sample

# TEST REPORT

Report No.:

SHE23100101-01DE

Date:

2024-05-30

Page 34 of 36

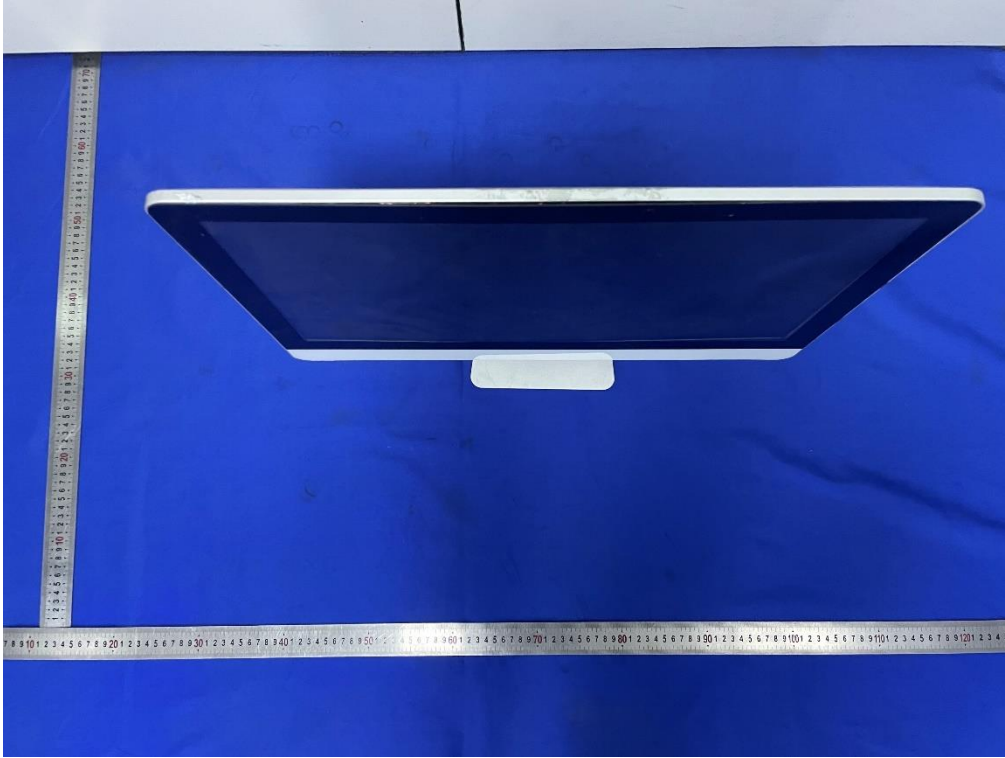

Top of the sample

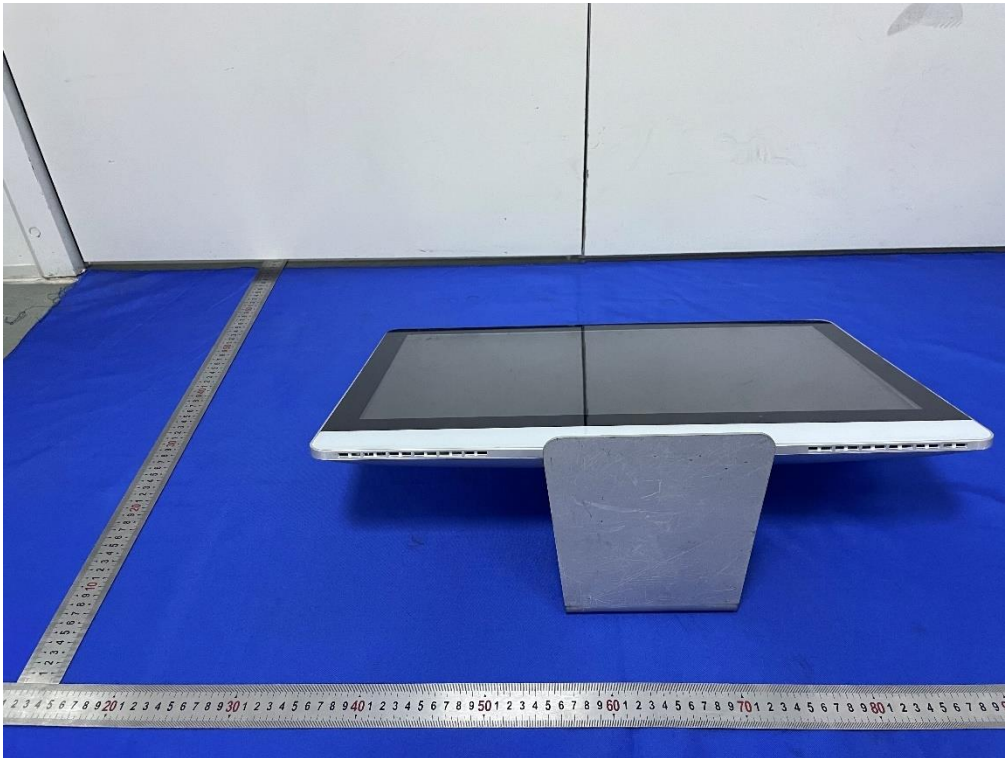

Bottom of the sample

# TEST REPORT

Report No.: SHE23100101-01DE

Date: 2024-05-30

Page 35 of 36

## 5.2 Set-up for Conducted Emissions



## 5.3 Set-up for Conducted RF test at Antenna Port



# TEST REPORT

Report No.: SHE23100101-01DE

Date: 2024-05-30

Page 36 of 36

## 5.4 Set-up for Spurious Emissions below 1GHz

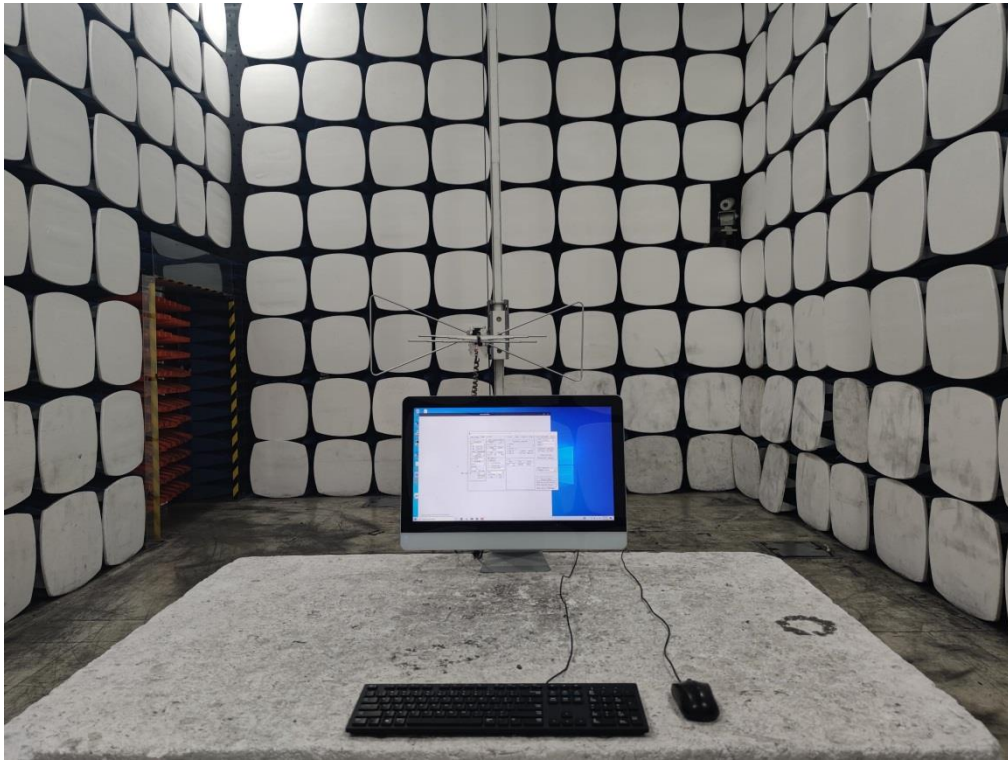

## 5.5 Set-up for Spurious Emissions above 1GHz



\*\*\*End of the report\*\*\*