

# TEST REPORT

Report No.: SHE23100101-01AE

Date: 2024-07-10

Page 1 of 65

**Applicant** : SKYTECH USA LLC.  
**Address of Applicant** : INCORP SERVICES, INC. 3458 LAKESHORE DRIVE  
TALLAHASSEE, FL 32312 US

**Product Name** : ALL IN ONE  
**Brand Name** : STGsivir & STGSivir  
**Model Name** : SIV0123  
**Sample Acquisition Method** : Sent by Client  
**Sample No.** : E23100101-01#01

**FCC ID** : 2BGCASIV0123

**Standards** : FCC CFR47 Part 15, Subpart C

**Date of Receipt** : 2023-11-03  
**Date of Test** : 2023-11-03~ 2024-07-09  
**Date of Issue** : 2024-07-10

**Remark:**

*This report details the results of the testing carried out on one sample, the results contained in this report do not relate to other samples of the same product. The manufacturer should ensure that all products in series production are in conformity with the product sample detailed in this report.*

Prepared by: Erik Yang  
(Erik Yang)

Reviewed by: Jennifer Zhou  
(Jennifer Zhou)

Approved by: Echo Mu  
(Authorized signatory: Echo Mu)

# TEST REPORT

Report No.: SHE23100101-01AE

Date: 2024-07-10

Page 2 of 65

## Contents

<b>1</b>	<b>GENERAL INFORMATION</b>	<b>3</b>
1.1	TESTING LABORATORY	3
1.2	DETAILS OF APPLICATION	3
1.3	DETAILS OF EUT	3
1.4	TEST METHODOLOGY	4
1.5	TEST SUMMARY	5
<b>2</b>	<b>TEST CONDITION</b>	<b>6</b>
2.1	ENVIRONMENTAL CONDITIONS	6
2.2	EQUIPMENT LIST	6
2.3	MEASUREMENT UNCERTAINTY	7
<b>3</b>	<b>TEST SET-UP AND OPERATION MODES</b>	<b>8</b>
3.1	DETAILS OF TEST MODE	8
3.2	SPECIAL ACCESSORIES AND AUXILIARY EQUIPMENT	9
3.3	SUPPORT SOFTWARE	9
3.4	TEST SETUP DIAGRAM	9
<b>4</b>	<b>TEST RESULTS</b>	<b>11</b>
4.1	TRANSMITTER REQUIREMENT & TEST SUITES	11
4.1.1	<i>Antenna Requirement</i>	11
4.1.2	<i>Maximum conducted (average) output power</i>	12
4.1.3	<i>6dB Bandwidth and 99% Bandwidth</i>	13
4.1.4	<i>Maximum conducted output power spectral density</i>	26
4.1.5	<i>Conducted Spurious Emission &amp; Authorized-band band-edge</i>	33
4.1.6	<i>Radiated Emission</i>	56
4.1.7	<i>Band Edge (Restricted-band band-edge)</i>	57
4.2	MAINS EMISSIONS	58
4.2.1	<i>Conducted Emission on AC Mains</i>	58
<b>5</b>	<b>APPENDIXES</b>	<b>61</b>
5.1	PHOTOGRAPHS OF THE SAMPLE	61
5.2	SET-UP FOR CONDUCTED EMISSIONS	64
5.3	SET-UP FOR CONDUCTED RF TEST AT ANTENNA PORT	64
5.4	SET-UP FOR SPURIOUS EMISSIONS BELOW 1GHZ	65
5.5	SET-UP FOR SPURIOUS EMISSIONS ABOVE 1GHZ	65

# TEST REPORT

Report No.: SHE23100101-01AE

Date: 2024-07-10

Page 3 of 65

## 1 General Information

### 1.1 Testing Laboratory

Company Name	ICAS Testing Technology Service (Shanghai) Co., Ltd.
Address	No.1298, Pingan Road, Minhang District, Shanghai, China
Telephone	0086 21-51682999
Fax	0086 21-54711112
Homepage	www.icasiso.com

### 1.2 Details of Application

Applicant Company Name	SKYTECH USA LLC.
Address	INCORP SERVICES, INC. 3458 LAKESHORE DRIVE TALLAHASSEE, FL 32312 US
Contact Person	Hu yan
Telephone	001-647-8892-868
Email	yan.hu@astsys.com
Manufacturer Company Name	SKYTECH USA LLC.
Address	INCORP SERVICES, INC. 3458 LAKESHORE DRIVE TALLAHASSEE, FL 32312 US
Factory Company Name	SKYTECH USA LLC.
Address	INCORP SERVICES, INC. 3458 LAKESHORE DRIVE TALLAHASSEE, FL 32312 US

### 1.3 Details of EUT

Product Name	ALL IN ONE
Brand Name	STGsvir & STGSvir
Test Model Name	SIV0123
FCC ID	2BGCASIV0123
Mode of Operation	WLAN 802.11b/g/n(HT20/40)
Conducted (average) output power	IEEE 802.11b: 14.93dBm IEEE 802.11g: 13.71dBm IEEE 802.11n(20): 13.09dBm IEEE 802.11n(40): 11.88dBm
Frequency Range	2400MHz ~ 2483.5MHz
Channel Separation	5 MHz
Number of channels	11
Modulation Type	802.11b: DSSS(CCK, DQPSK, DBPSK) 802.11g/n(20M/40M): OFDM(64QAM, 16QAM, QPSK, BPSK)
Antenna Type	Internal Antenna
Antenna Gain	1.83dBi

# TEST REPORT

Report No.: SHE23100101-01AE

Date: 2024-07-10

Page 4 of 65

<b>Extreme Temperature Range</b>	0°C~ +70°C
<b>Test Voltage</b>	AC 100-240V 50/60Hz
<b>Hardware Version</b>	1.2
<b>Software Version</b>	2024.10.139.200_Drv_3.00.0044.L
<b>RF power setting in TEST SW</b>	802.11b:Realtek 11ac 8821C PCIE WLAN MP Diagnostic Program 0.0007.00.20190801_Power level setting_63 802.11g:Realtek 11ac 8821C PCIE WLAN MP Diagnostic Program 0.0007.00.20190801_Power level setting_63 802.11n(HT20): Realtek 11ac 8821C PCIE WLAN MP Diagnostic Program 0.0007.00.20190801_Power level setting_60 802.11n(HT40): Realtek 11ac 8821C PCIE WLAN MP Diagnostic Program 0.0007.00.20190801_Power level setting_56

Note:

1. The above information was declared by the manufacture.
2. For more details, please refer to the User's manual of the EUT.

## Channel List

Channel	Frequency	Channel	Frequency	Channel	Frequency
1	2.412GHz	5	2.432GHz	9	2.452GHz
2	2.417GHz	6	2.437GHz	10	2.457GHz
3	2.422GHz	7	2.442GHz	11	2.462GHz
4	2.427GHz	8	2.447GHz		

Note:

For 20MHz bandwidth system use Channel 1 to Channel 11

For 40MHz bandwidth system use Channel 3 to Channel 9

## 1.4 Test Methodology

47 CFR Part 15, Subpart C	Telecommunication-Radio Frequency Devices-Intentional Radiators
KDB Publication 558074 D01 v05r02	15.247 Meas Guidance.
ANSI C63.10-2013	American National Standard for Testing Unlicensed Wireless Devices

Note(s):

All test items were verified and recorded according to the standards and without any addition/deviation/exclusion during the test.

# TEST REPORT

Report No.: SHE23100101-01AE

Date: 2024-07-10

Page 5 of 65

## 1.5 Test Summary

Test Item	FCC Rules	Result
Antenna Requirement	FCC Part 15.247(b)(4), Part 15.203	PASS
Maximum conducted (average) output power	FCC Part 15.247(b)(3)	PASS
6dB Bandwidth and 99% Bandwidth	FCC Part 15.247(a)(2)	PASS
Maximum conducted output power spectral density	FCC Part 15.247(e)	PASS
Conducted Spurious Emission & Authorized-band band-edge	FCC Part 15.247(d)	PASS
Radiated Emission	FCC Part 15.247(d), 15.205, 15.209	PASS
Band Edge (Restricted-band band-edge)	FCC Part 15.247(d), 15.205, 15.209	PASS
Conducted Emission on AC Mains	FCC Part 15.207(a)	PASS

# TEST REPORT

Report No.: SHE23100101-01AE

Date: 2024-07-10

Page 6 of 65

## 2 Test Condition

### 2.1 Environmental conditions

Temperature (°C)	18-25
Humidity (%RH)	40-65
Barometric Pressure (mbar)	960-1060

### 2.2 Equipment List

Name of Equipment	Manufacturer	Model	Serial No.	Cal. Date	Cal. Due
Spectrum Analyzer	Keysight	N9020B	MY59260184	2023-07-27	2024-07-26
Spectrum Analyzer	Rohde & Schwarz	FSV40N	101450	2023-06-08	2024-06-07
Spectrum Analyzer	Rohde & Schwarz	FSV40N	101450	2024-06-04	2025-06-03
Signal Generator	Rohde & Schwarz	SMR27	100184	2023-07-27	2024-07-26
EMI Test Receiver	Rohde & Schwarz	ESPI3	100173	2023-06-08	2024-06-07
EMI Test Receiver	Rohde & Schwarz	ESPI3	100173	2024-06-05	2025-06-04
EMI Test Receiver	Rohde & Schwarz	ESR 7	101911	2023-06-08	2024-06-07
EMI Test Receiver	Rohde & Schwarz	ESR 7	101911	2024-06-04	2025-06-03
V-network	SCHWARZBECK	NSLK 8127	8127-902	2023-06-07	2024-06-06
V-network	SCHWARZBECK	NSLK 8127	8127-902	2024-06-05	2025-06-04
Attenuator	SCHWARZBECK	VTSD 9561-FN	/	2023-06-06	2024-06-05
Attenuator	SCHWARZBECK	VTSD 9561-FN	/	2024-06-05	2025-06-04
Broadband Antenna	SCHWARZBECK	VULB9163	9163-1037	2023-03-22	2025-03-21
Horn Antenna-18G	SCHWARZBECK	BBHA9120D	9120D-1775	2023-06-13	2025-06-12
Loop Antenna	SCHWARZBECK	FMZB 1513	N/A	2023-06-09	2025-06-08
Horn Antenna-40G	YINGLIAN	LB-180400-KF	N/A	2023-06-18	2025-06-17
Broadband Preamplifier	SCHWARZBECK	BBV 9718	346	2023-06-08	2024-06-07
Broadband Preamplifier	SCHWARZBECK	BBV 9718	346	2024-06-04	2025-06-03
EMC chamber 9*6*6(L*W*H)	CHANGNING	966	N/A	2023-06-09	2025-06-08
Shielded Enclosure 8*5*4(L*W*H)	CHANGNING	854	N/A	2023-06-09	2025-06-08
Test Software	BL	BL410_E	Version:1.0.0.117	N/A	N/A
Test Software	BL	BL410_R	Version:2.1.1.409	N/A	N/A

# TEST REPORT

Report No.: SHE23100101-01AE

Date: 2024-07-10

Page 7 of 65

## 2.3 Measurement Uncertainty

The uncertainty is calculated using the methods suggested in the “Guide to the Expression of Uncertainty in measurement” (GUM) published by CISPR and ANSI. The reported uncertainty of measurement  $y \pm U$ , where expanded uncertainty  $U$  is based on a standard uncertainty multiplied by a coverage factor of  $k=2$ , providing a level of confidence of approximately 95.45%.

Parameter		Uncertainty
Antenna Port Conducted Emission	< 1GHz	$\pm 1.5$ dB
	> 1GHz	$\pm 1.5$ dB
Radiated Emission	9KHz – 30MHz	$\pm 3.42$ dB
	30 MHz – 1GHz	$\pm 5.01$ dB
	> 1GHz	$\pm 5.21$ dB
Conducted Emission on AC Mains	150kHz-30MHz	$\pm 2.68$ dB
Occupied Channel Bandwidth		$\pm 5$ %
Maximum Conducted Output Power		$\pm 0.64$ dB
Maximum Conducted Output Power Spectral Density		$\pm 1.18$ dB

# TEST REPORT

Report No.: SHE23100101-01AE

Date: 2024-07-10

Page 8 of 65

## 3 Test Set-up and Operation Modes

### 3.1 Details of Test Mode

Using test software (Realtek 11ac 8821C PCIE WLAN MP Diagnostic Program 0.0007.00.20190801) was control EUT work in continuous transmitting mode. Select test channel as below:

For 802.11b/g/n (HT20)

Channel	Frequency
The lowest channel (CH1)	2412MHz
The middle channel (CH6)	2437MHz
The highest channel (CH11)	2462MHz

For 802.11n(HT40)

Channel	Frequency
The lowest channel (CH3)	2422MHz
The middle channel (CH6)	2437MHz
The highest channel (CH9)	2452MHz

Through Pre-scan under all rate at lowest channel, the data rate as below table described is the worst case, so we choose these data rate for test.

Type	Data rate
802.11b	11Mbps
802.11g	18Mbps
802.11n(20M)	MCS4
802.11n(40M)	MCS6

The basic operation modes are:

- A. On
  - 1. WLAN mode
    - a. Transmitting
      - i. Low Channel
      - ii. Middle Channel
      - iii. High Channel
    - b. Receiving
- B. Standby
- C. Off



# TEST REPORT

Report No.: SHE23100101-01AE

Date: 2024-07-10

Page 9 of 65

## 3.2 Special Accessories and Auxiliary Equipment

Description	Manufacturer	Model Name	Serial No.
AC/DC ADAPTER	Guangdong Mingxin Power Technologies Co., Ltd	MX120Z-19006300	MX120Z19006300
Mouse	Dell	MS116t1	CN-065K5F-LO300-248-0VP2
Keyboard	Dell	KB216P	CN-0M4W71-73826-6C801SQ-A02

## 3.3 Support Software

Description	Manufacturer	Software Name
Software	N/A	Realtek 11ac 8821C PCIE WLAN MP Diagnostic Program 0.0007.00.20190801

## 3.4 Test Setup Diagram

Diagram of Measurement Configuration for Radiation Test

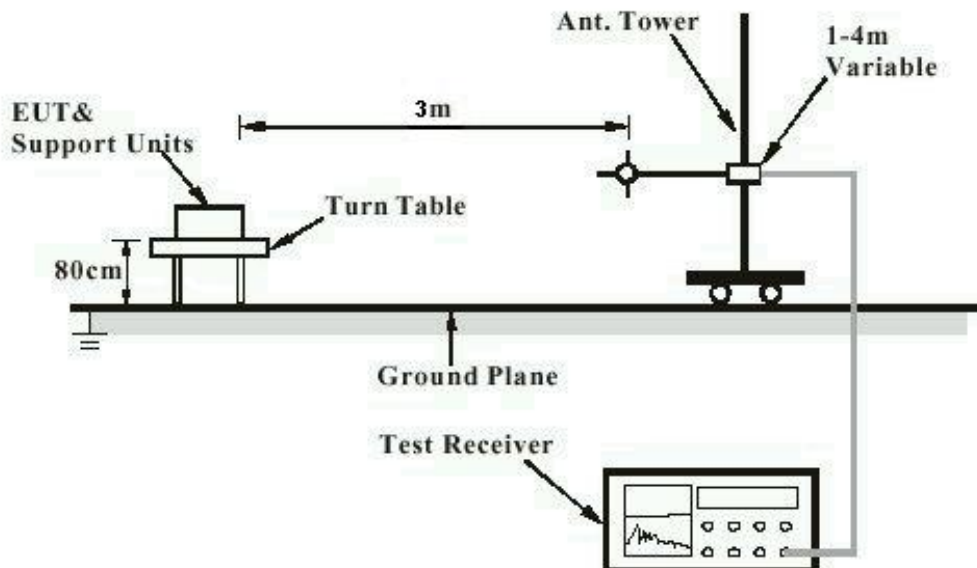

Note: Measurements above 1GHz are done with a table height of 1.5m. In addition, there is RF absorbing material on the floor of the test site for above 1GHz measurement.

# TEST REPORT

Report No.: SHE23100101-01AE

Date: 2024-07-10

Page 10 of 65

## Diagram of Measurement Equipment Configuration for Conduction Measurement

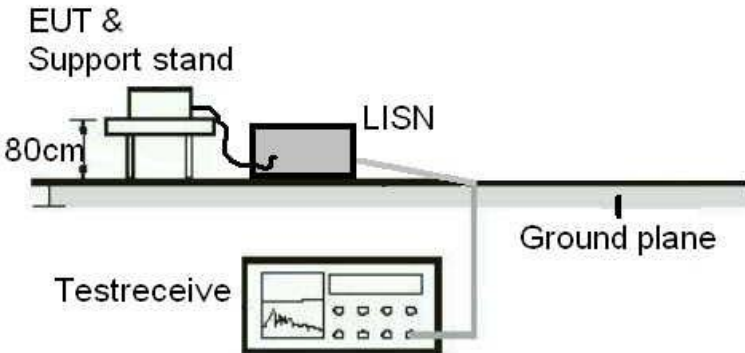

## Diagram of Measurement Equipment Configuration for Transmitter Measurement

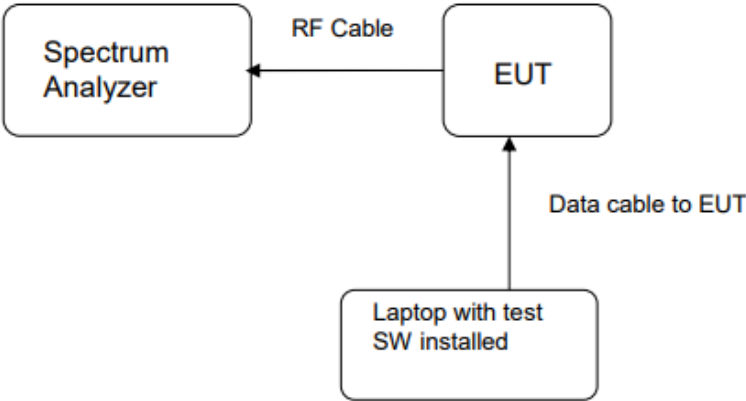

# TEST REPORT

Report No.: SHE23100101-01AE

Date: 2024-07-10

Page 11 of 65

## 4 Test Results

### 4.1 Transmitter Requirement & Test Suites

#### 4.1.1 Antenna Requirement

RESULT:

**PASS**

Test standard : FCC Part 15.247(b)(4), Part 15.203  
Requirement : An intentional radiator shall be designed to ensure that no antenna other than that furnished by the responsible party shall be used with the device. The use of a permanently attached antenna or of an antenna that uses a unique coupling to the intentional radiator shall be considered sufficient to comply with the provisions of this section. The manufacturer may design the unit so that a broken antenna can be replaced by the user, but the use of a standard antenna jack or electrical connector is prohibited. In addition, If transmitting antennas of directional gain greater than 6dBi are used, both the maximum conducted output power and the maximum power spectral density shall be reduced by the amount in dB that the directional gain of the antenna exceeds 6dBi.

According to the manufacturer declaration, the EUT has an antenna with a directional gain of 1.83dBi. The antenna is an internal antenna with no possibility of replacement with a non-approved antenna by the end-user.

Therefore, the EUT is considered to comply with this provision.

# TEST REPORT

Report No.: SHE23100101-01AE

Date: 2024-07-10

Page 12 of 65

## 4.1.2 Maximum conducted (average) output power

RESULT:

PASS

Test standard : FCC Part 15.247(b)(3)  
Requirement : ANSI C63.10-2013, Clause 11.9.2  
KDB 558074 D01 v05r02, Clause 8.3.2  
Kind of test site : Shielded room

### Test setup

Test Channel : Low/Middle/High  
Operation Mode : A.1.a  
Ambient temperature : 23.8°C  
Relative humidity : 46%

Table 1: Maximum conducted (average) output power

Test Mode	Duty Cycle (%)	Test Channel (MHz)	Maximum conducted (average) output power		Limit (W)
			(dBm)	(mW)	
802.11b	100	2412	13.82	24.10	≤1
		2437	14.86	30.62	
		2462	14.93	31.12	
802.11g	100	2412	13.32	21.48	
		2437	13.70	23.44	
		2462	13.71	23.50	
802.11n(HT20)	100	2412	12.54	17.95	
		2437	13.09	20.37	
		2462	12.97	19.82	
802.11n(HT40)	100	2422	11.59	14.42	
		2437	11.75	14.96	
		2452	11.88	15.42	

Notes:

1. Add  $[10 \log (1 / D)]$ , where D is the duty cycle, to the measured power to compute the average power during the actual transmission times.

# TEST REPORT

Report No.: SHE23100101-01AE

Date: 2024-07-10

Page 13 of 65

## 4.1.3 6dB Bandwidth and 99% Bandwidth

RESULT:

PASS

Test standard : FCC Part 15.247(a)(2)  
Requirement : ANSI C63.10-2013, Clause 11.8.1  
KDB 558074 D01 v05r02, Clause 8.2  
Kind of test site : Shielded room

### Test setup

Test Channel : Low/Middle/High  
Operation Mode : A.1.a  
Ambient temperature : 22.7°C  
Relative humidity : 47%

Table 2: 6dB Bandwidth and 99% Bandwidth

Test Mode	Test Channel (MHz)	6dB Bandwidth (MHz)	99% Bandwidth (MHz)	6dB Bandwidth Applicable Limit (MHz)
802.11b	2412	10.15	15.968	≥0.5
	2437	10.14	15.344	
	2462	10.09	15.415	
802.11g	2412	16.56	17.056	
	2437	16.56	17.103	
	2462	16.52	17.196	
802.11n(HT20)	2412	17.75	18.018	
	2437	17.74	17.994	
	2462	17.73	17.925	
802.11n(HT40)	2422	36.49	36.295	
	2437	36.48	36.242	
	2452	36.53	36.261	

# TEST REPORT

Report No.: SHE23100101-01AE

Date: 2024-07-10

Page 14 of 65

Figure 1: 6dB Bandwidth, 802.11b, 2412MHz

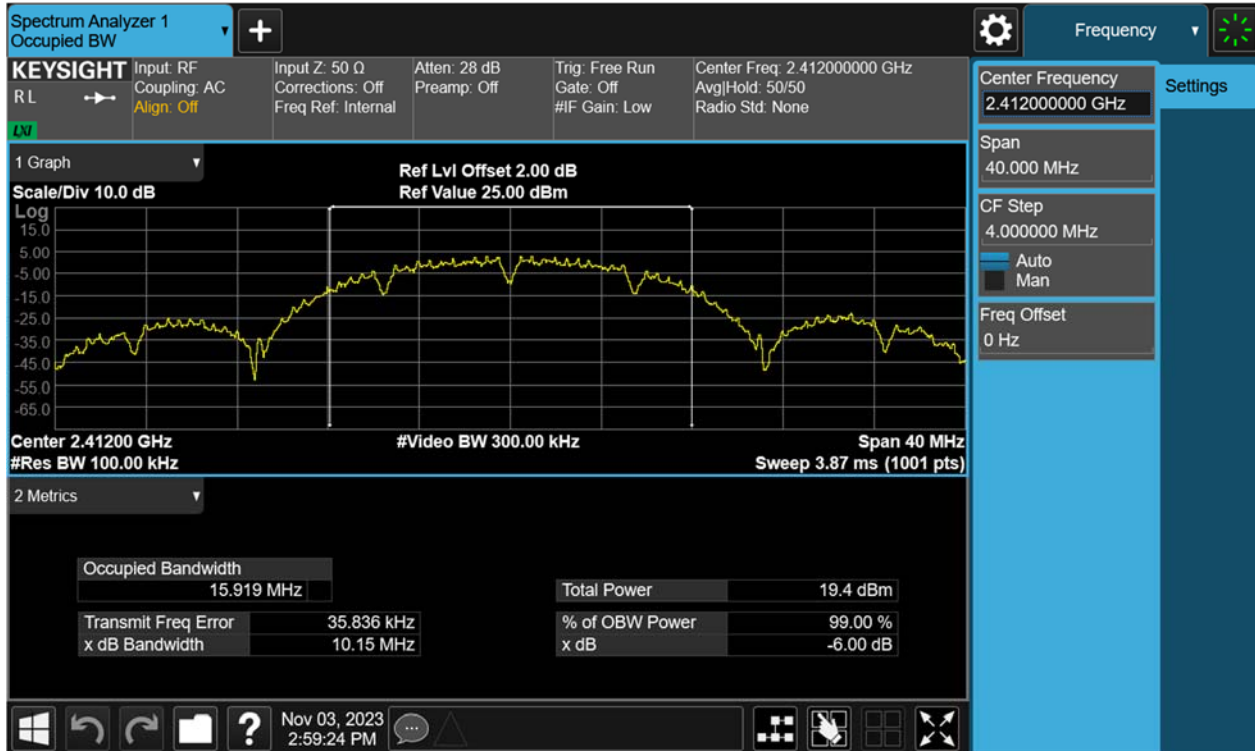

99% Bandwidth, 802.11b, 2412MHz



# TEST REPORT

Report No.: SHE23100101-01AE

Date: 2024-07-10

Page 15 of 65

Figure 2: 6dB Bandwidth, 802.11b, 2437MHz

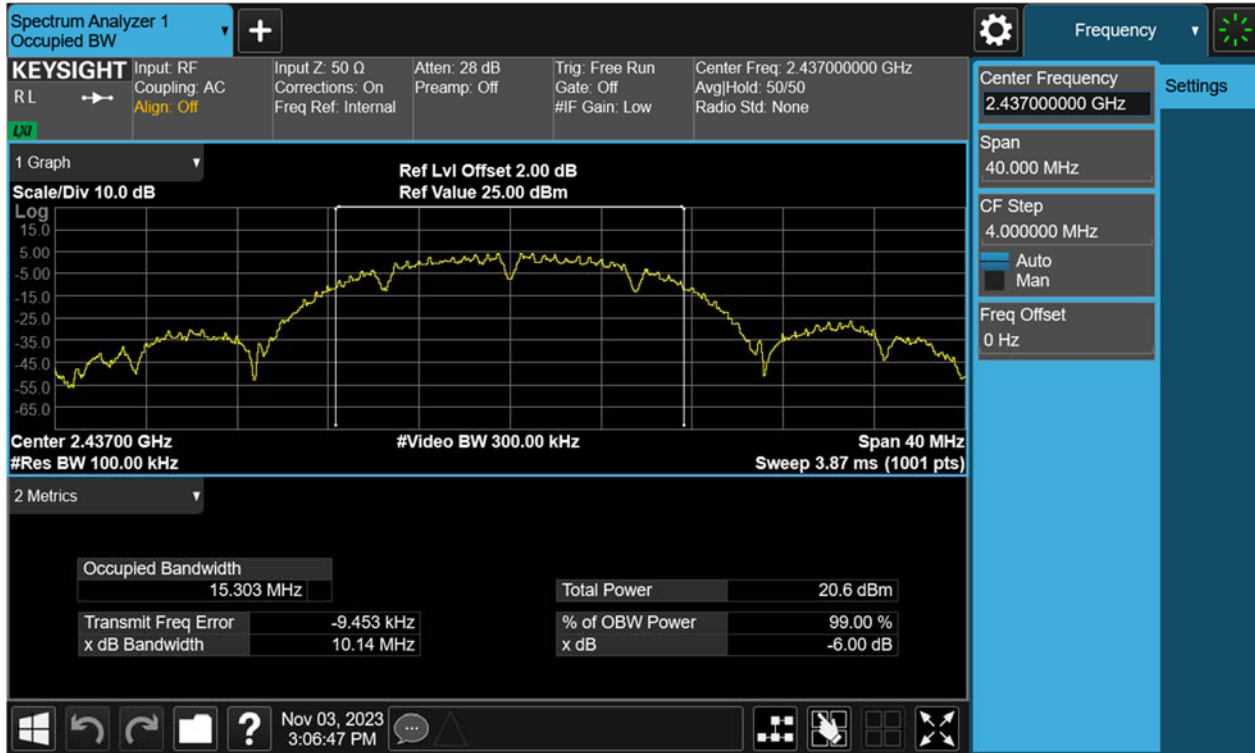

99% Bandwidth, 802.11b, 2437MHz

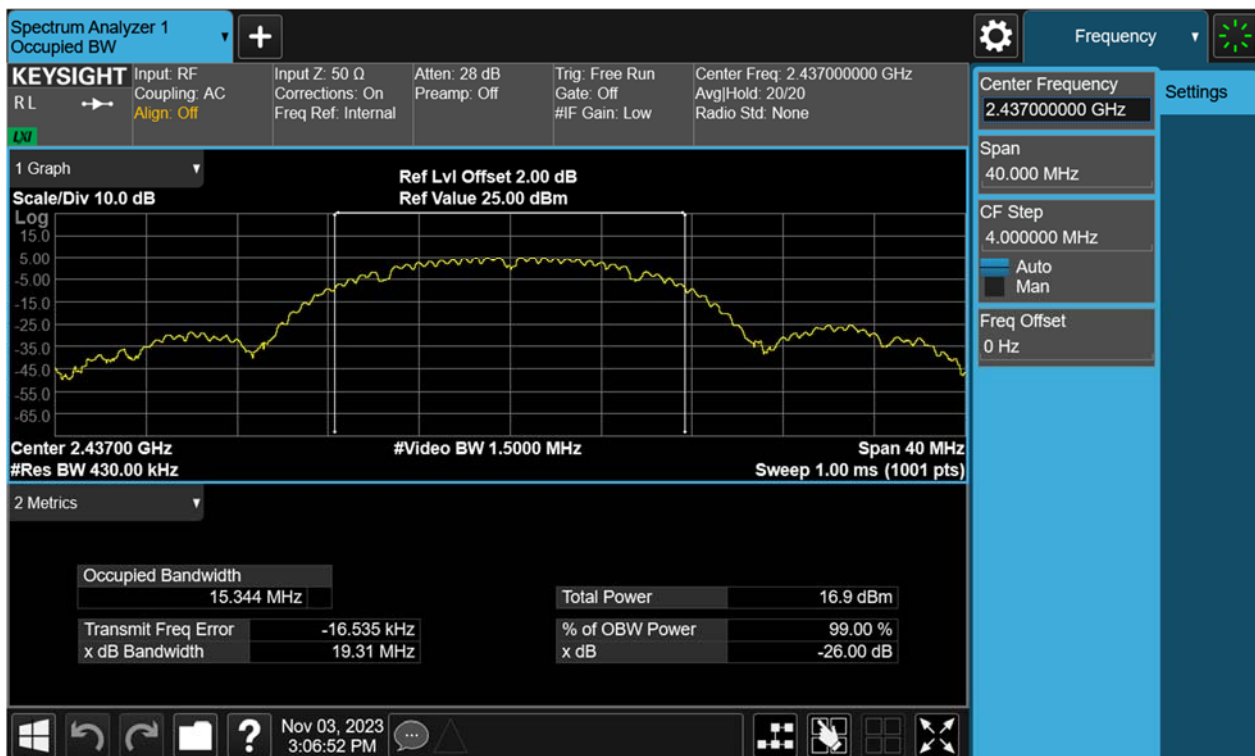

# TEST REPORT

Report No.: SHE23100101-01AE

Date: 2024-07-10

Page 16 of 65

Figure 3: 6dB Bandwidth, 802.11b, 2462MHz

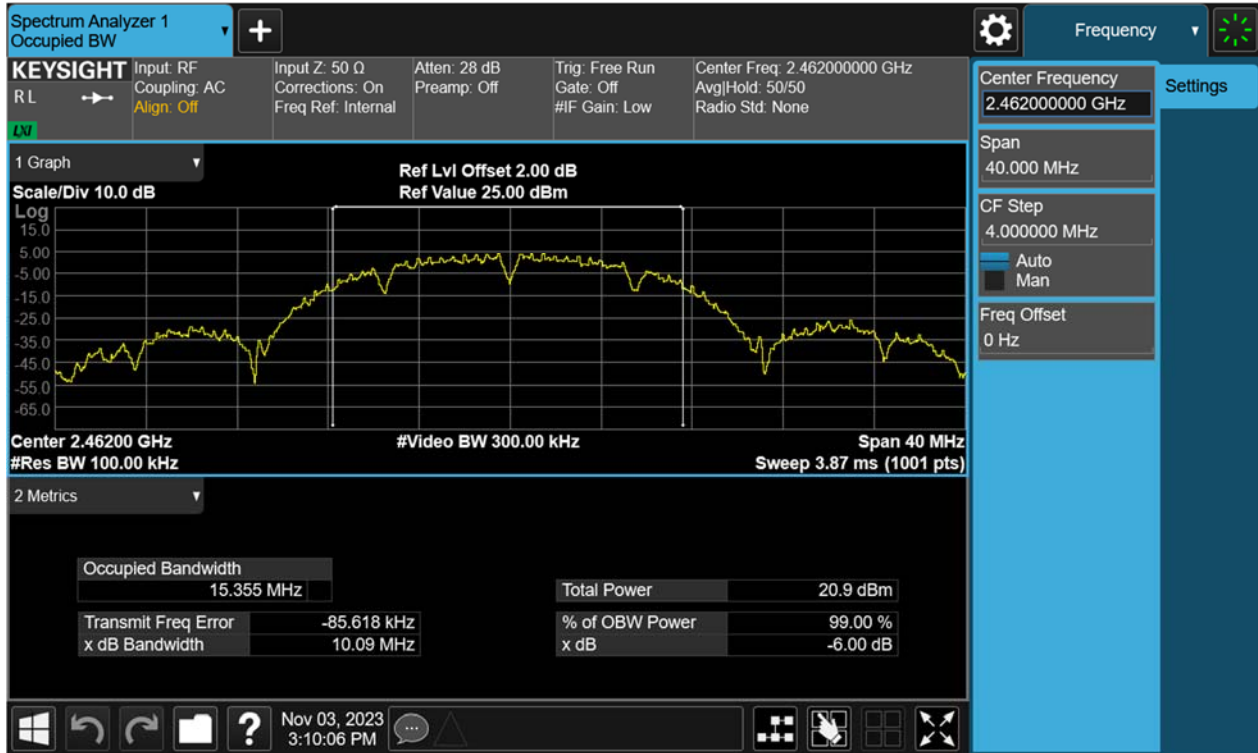

99% Bandwidth, 802.11b, 2462MHz





# TEST REPORT

Report No.: SHE23100101-01AE

Date: 2024-07-10

Page 17 of 65

Figure 4: 6dB Bandwidth, 802.11g, 2412MHz

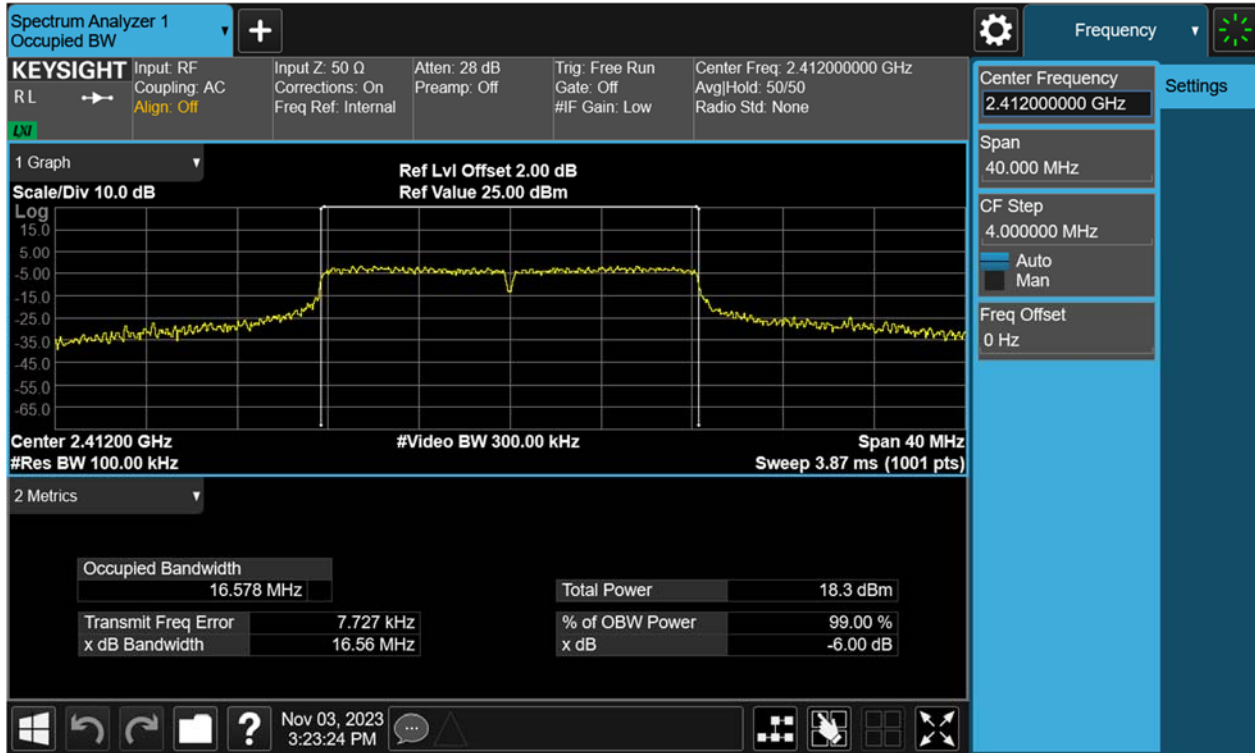

99% Bandwidth, 802.11g, 2412MHz

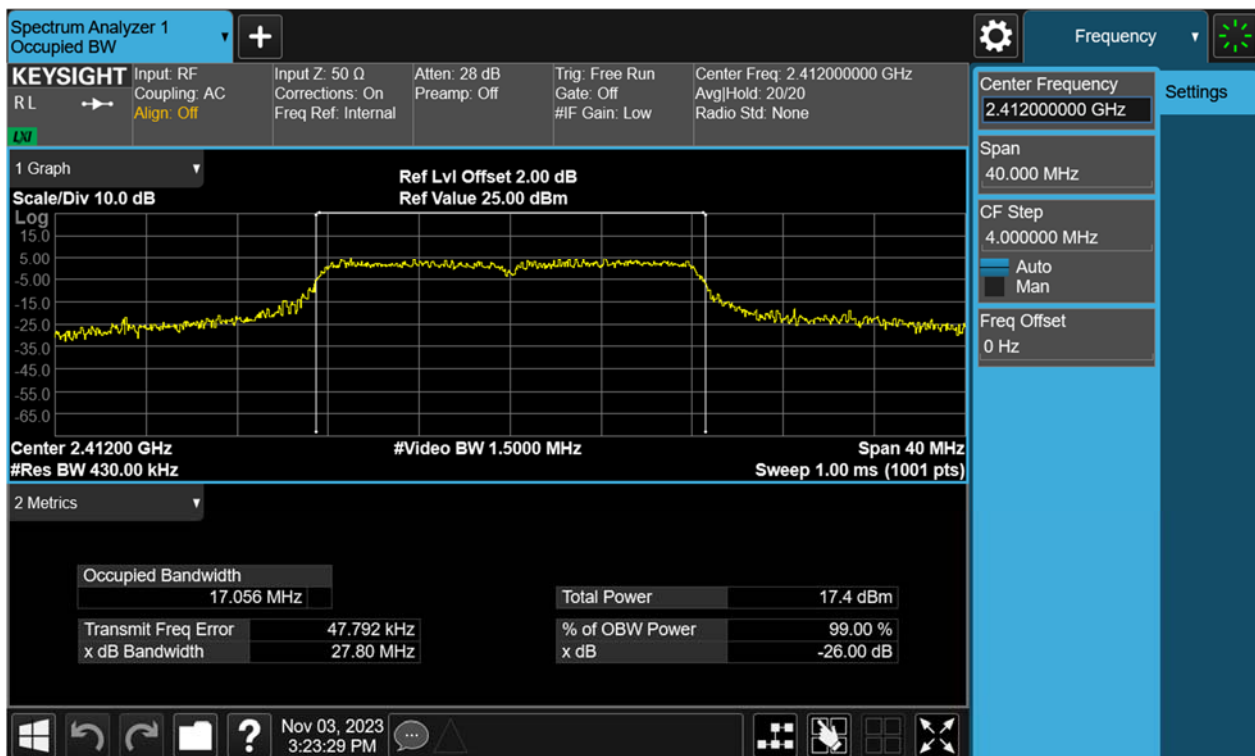

# TEST REPORT

Report No.: SHE23100101-01AE

Date: 2024-07-10

Page 18 of 65

Figure 5: 6dB Bandwidth, 802.11g, 2437MHz

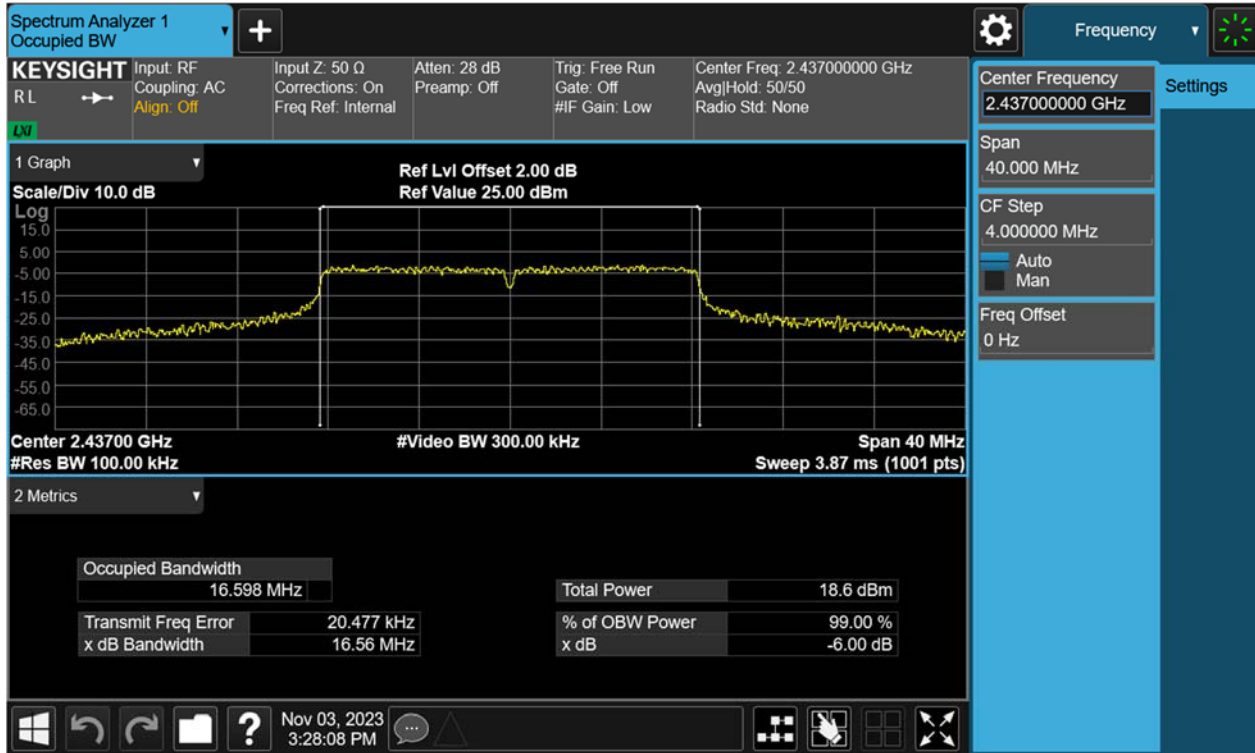

99% Bandwidth, 802.11g, 2437MHz

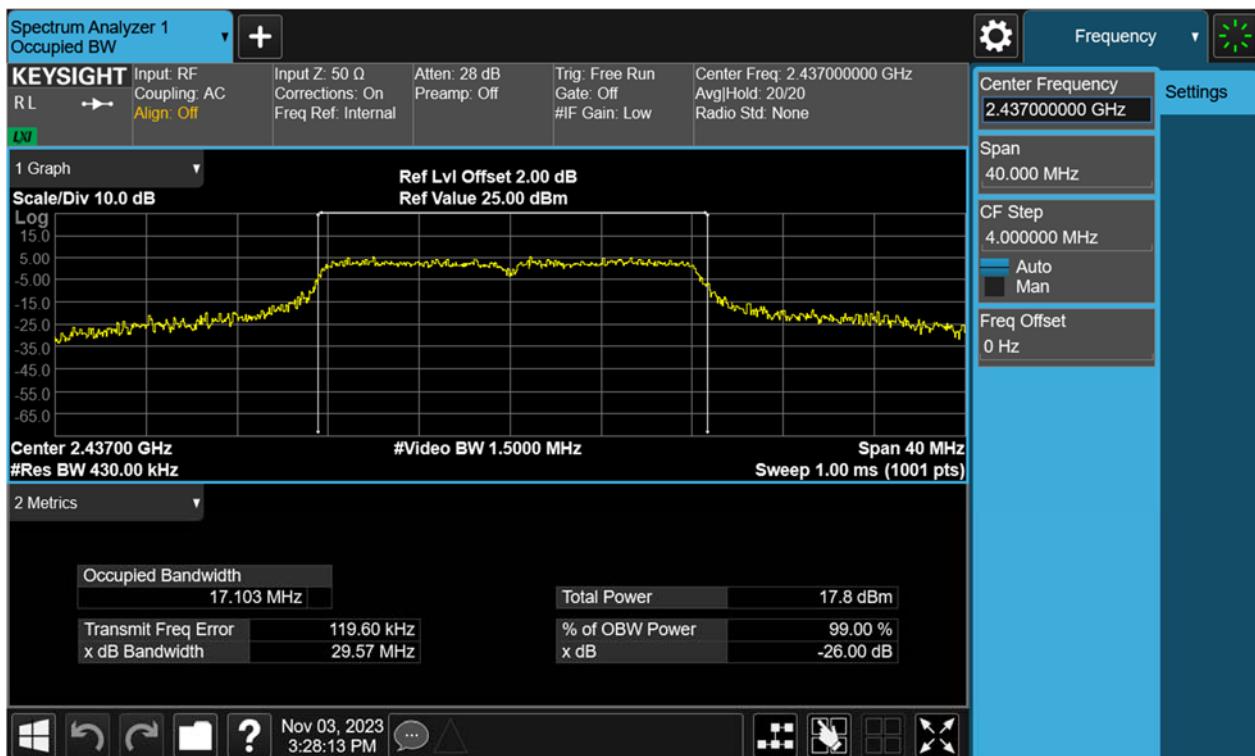

# TEST REPORT

Report No.: SHE23100101-01AE

Date: 2024-07-10

Page 19 of 65

Figure 6: 6dB Bandwidth, 802.11g, 2462MHz

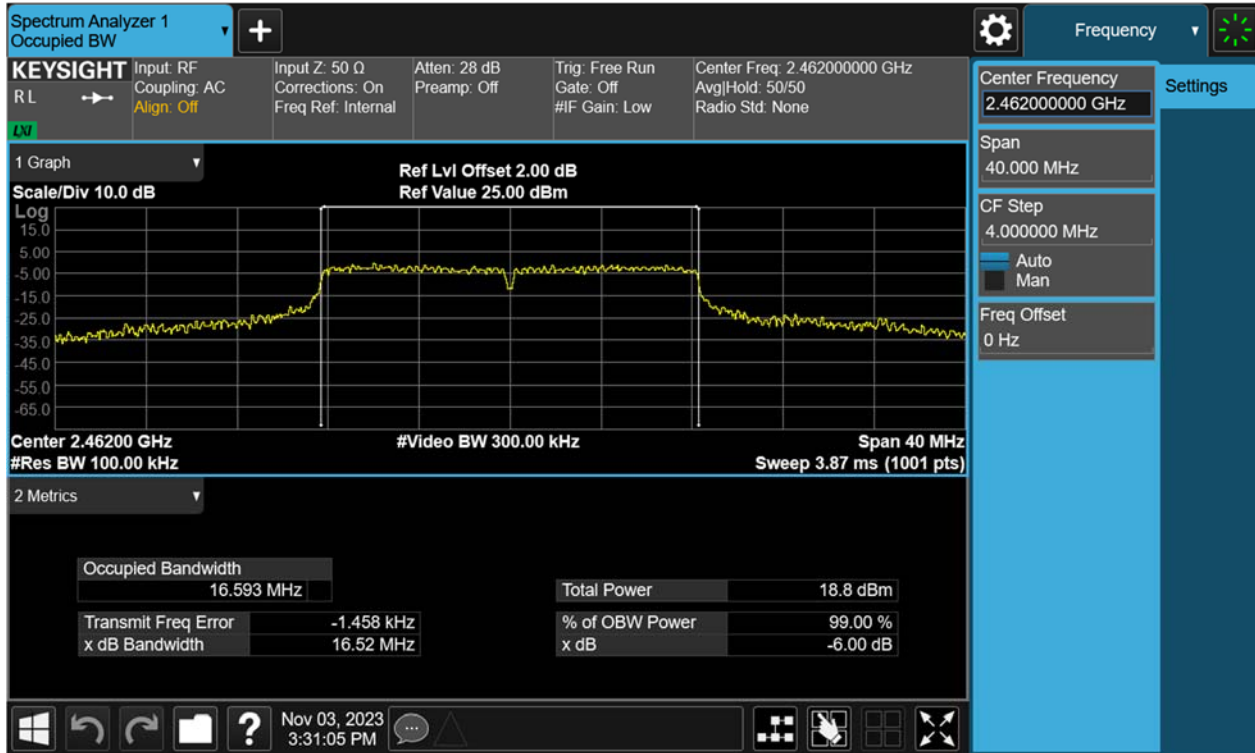

99% Bandwidth, 802.11g, 2462MHz

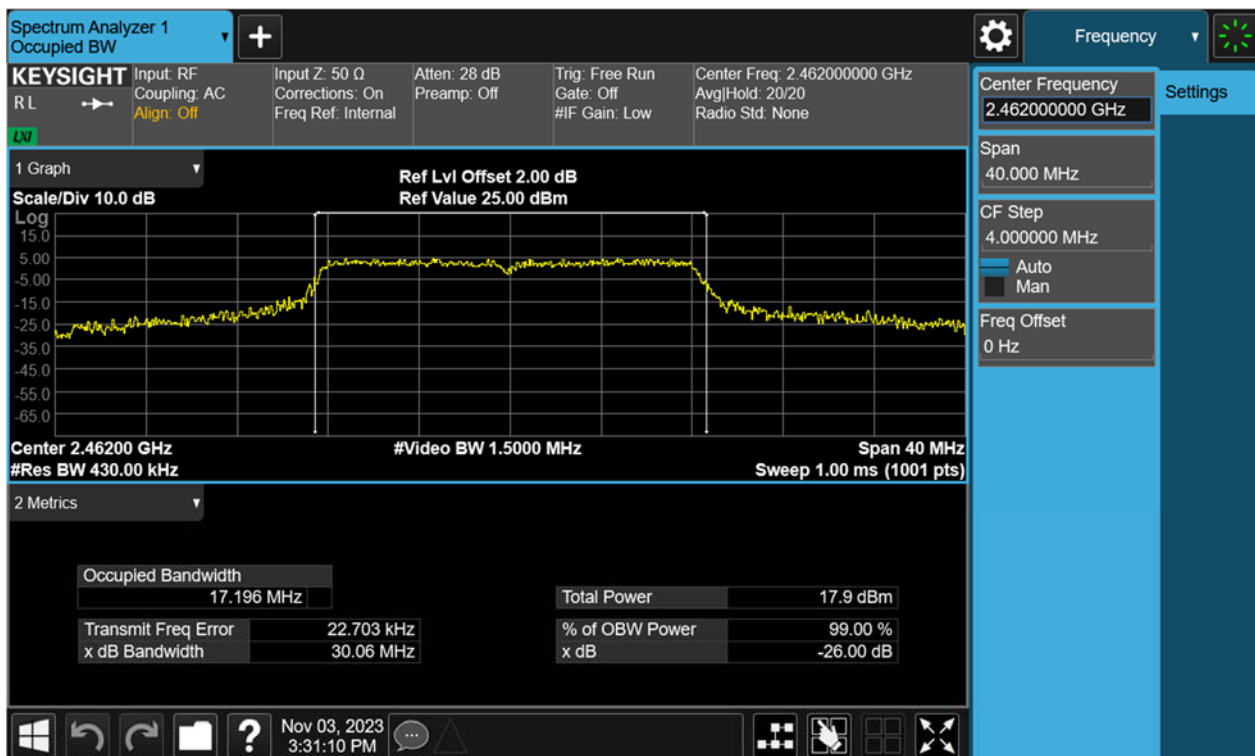

# TEST REPORT

Report No.: SHE23100101-01AE

Date: 2024-07-10

Page 20 of 65

Figure 7: 6dB Bandwidth, 802.11n(HT20), 2412MHz

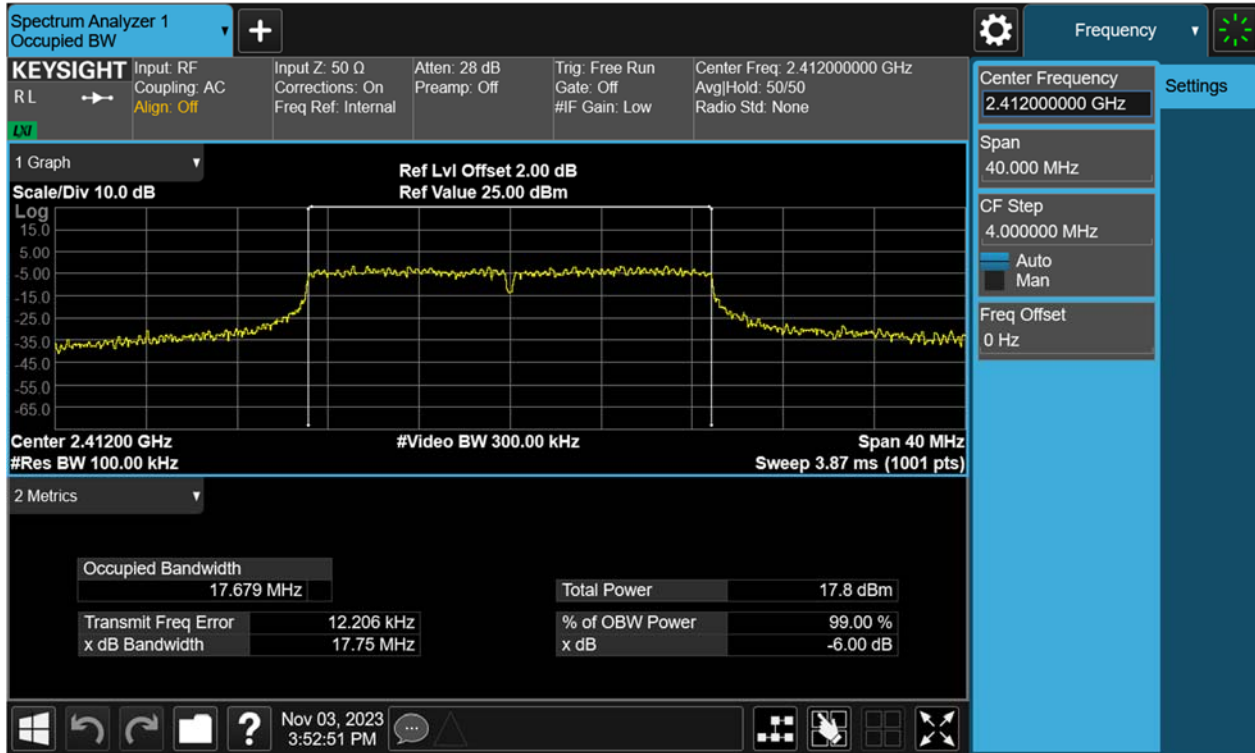

99% Bandwidth, 802.11n(HT20), 2412MHz

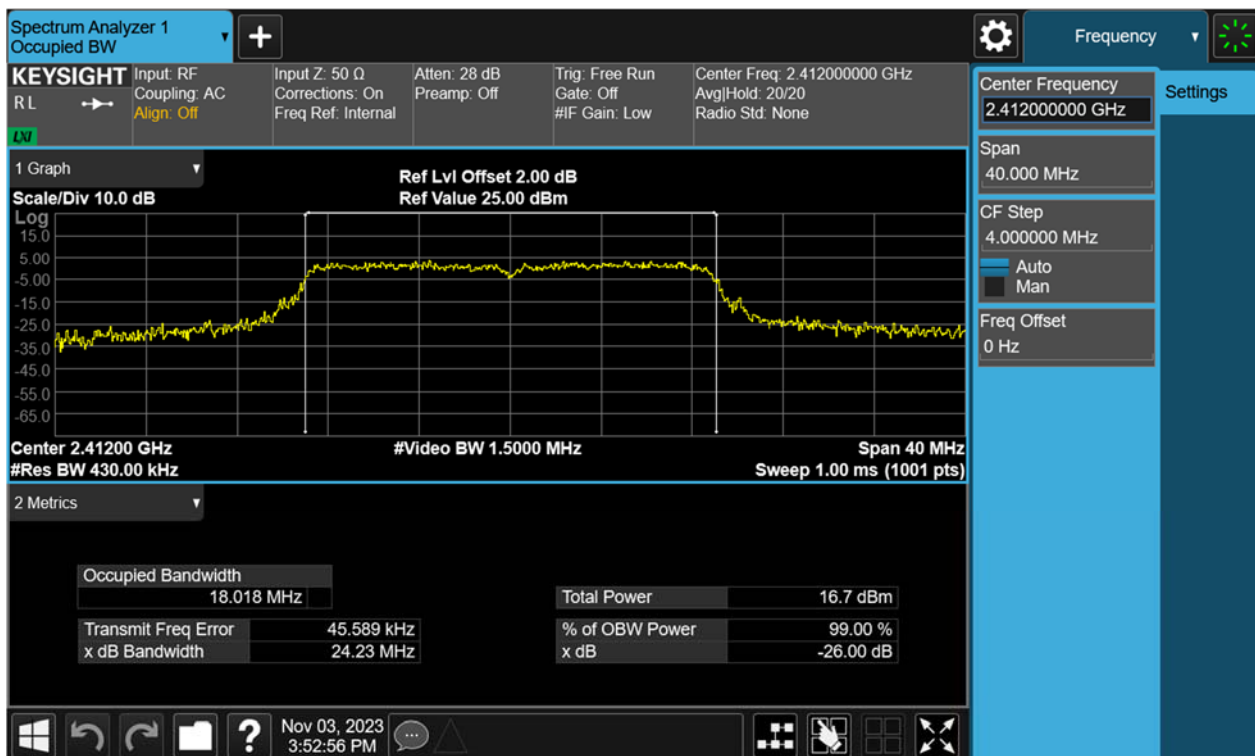

# TEST REPORT

Report No.: SHE23100101-01AE

Date: 2024-07-10

Page 21 of 65

Figure 8: 6dB Bandwidth, 802.11n(HT20), 2437MHz

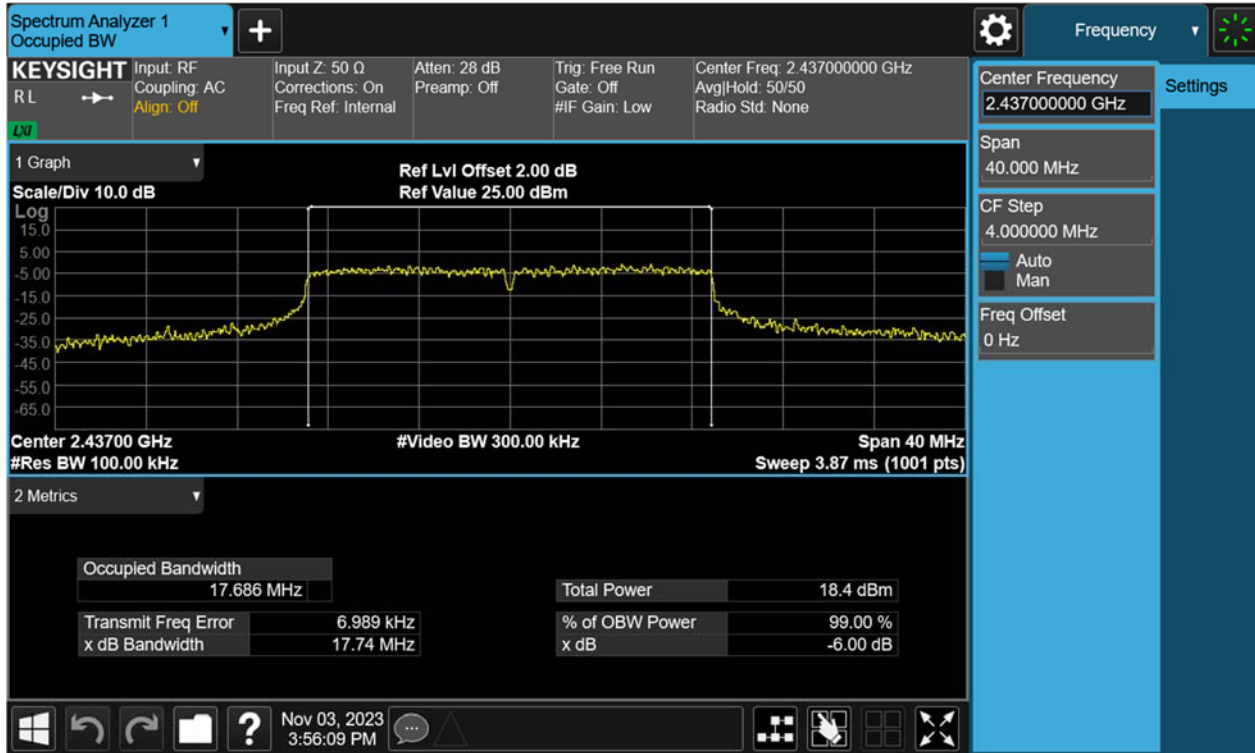

99% Bandwidth, 802.11n(HT20), 2437MHz

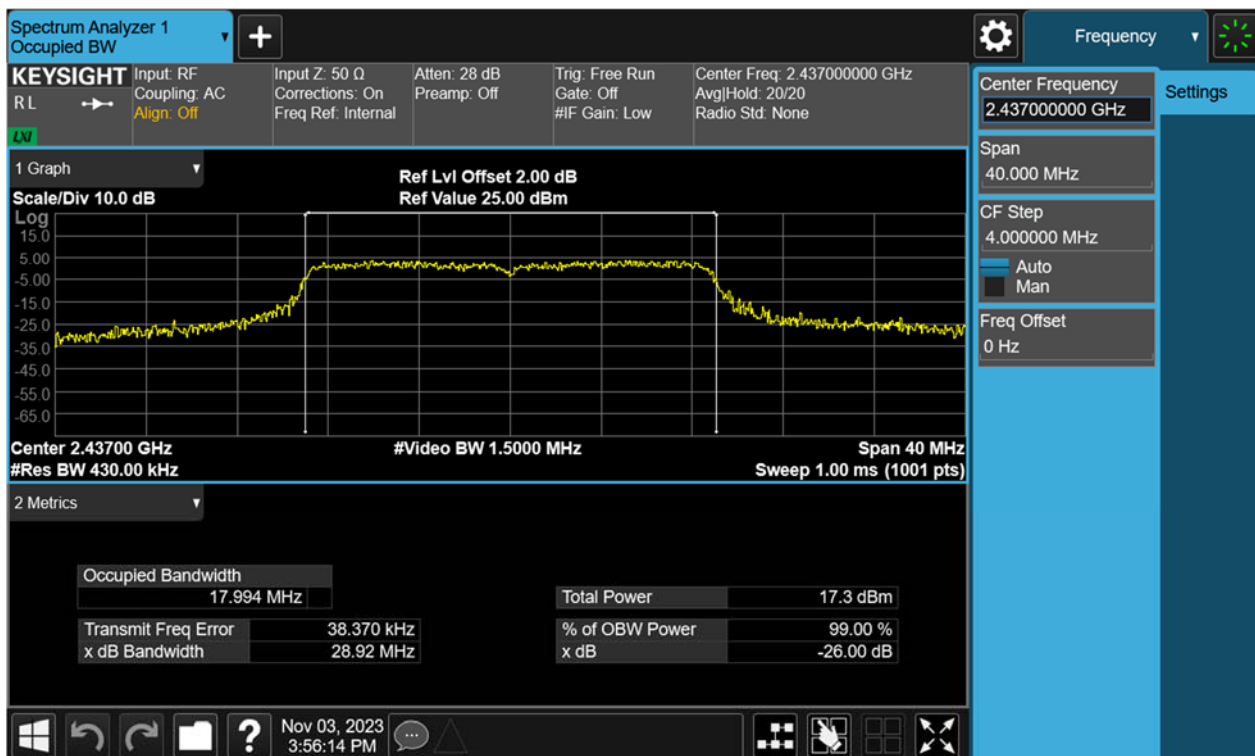

# TEST REPORT

Report No.: SHE23100101-01AE

Date: 2024-07-10

Page 22 of 65

Figure 9: 6dB Bandwidth, 802.11n(HT20), 2462MHz

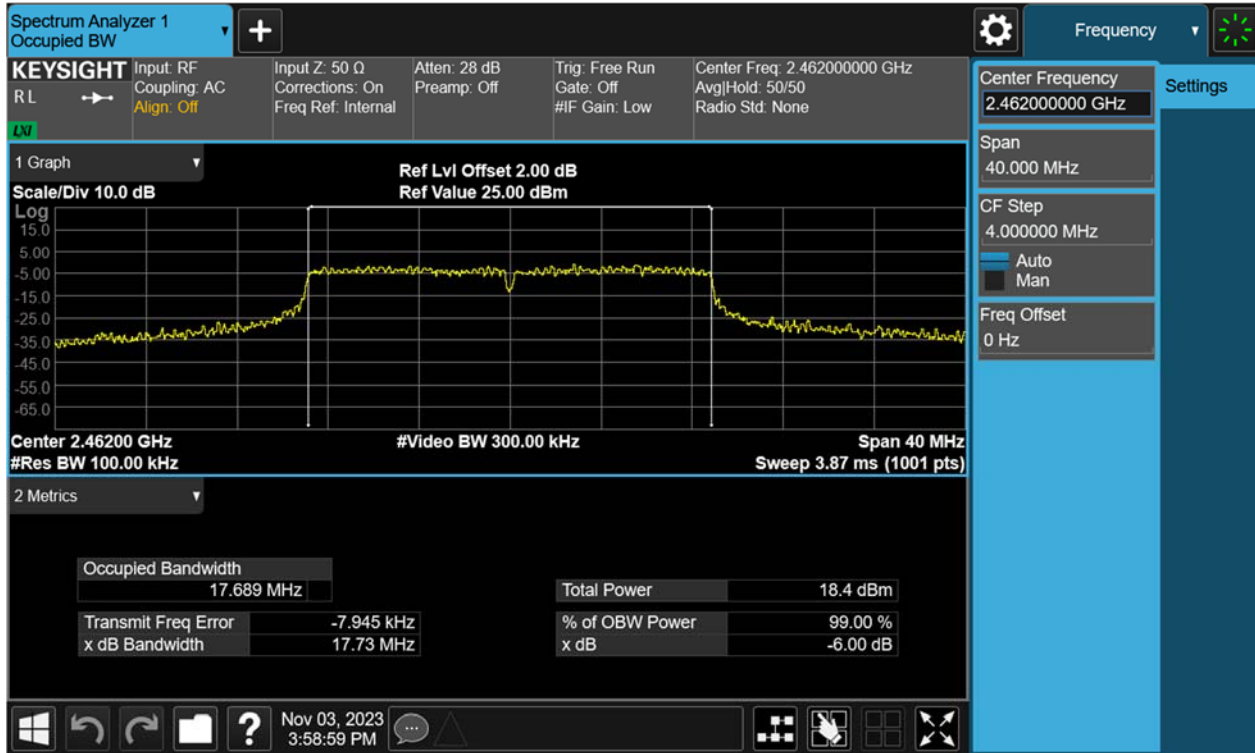

99% Bandwidth, 802.11n(HT20), 2462MHz

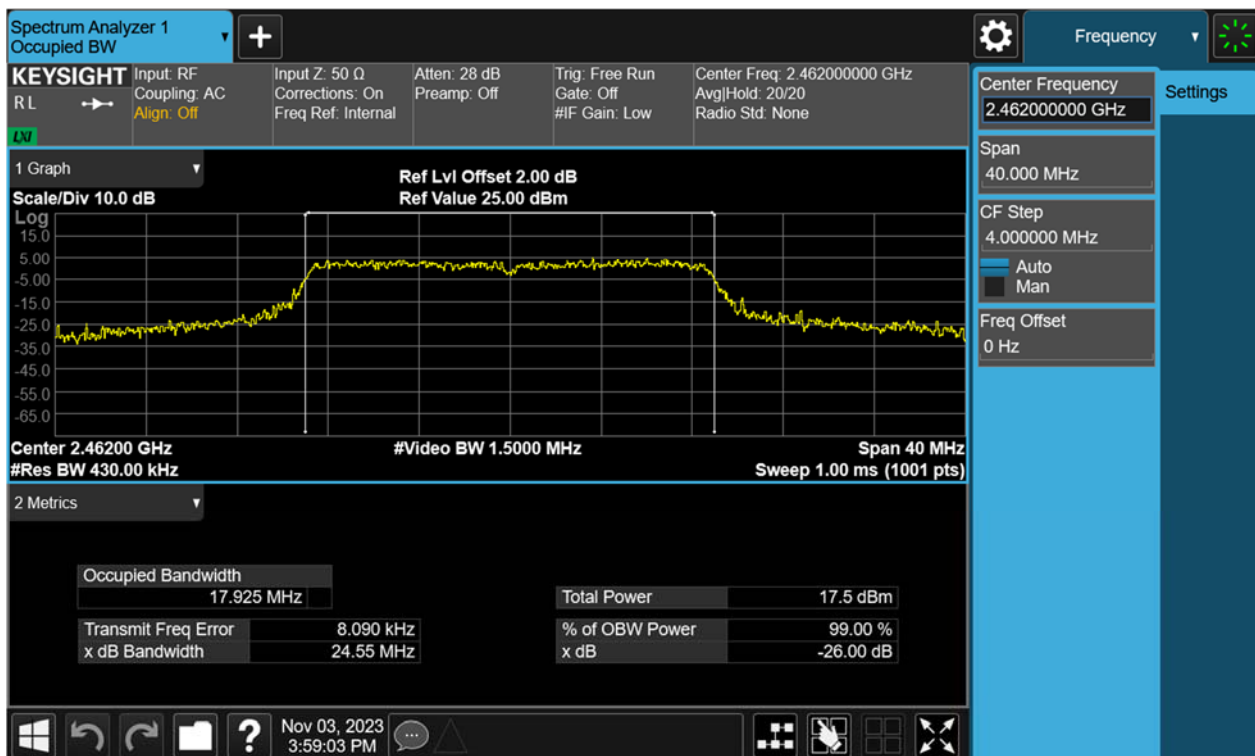

# TEST REPORT

Report No.: SHE23100101-01AE

Date: 2024-07-10

Page 23 of 65

Figure 10: 6dB Bandwidth, 802.11n(HT40), 2422MHz

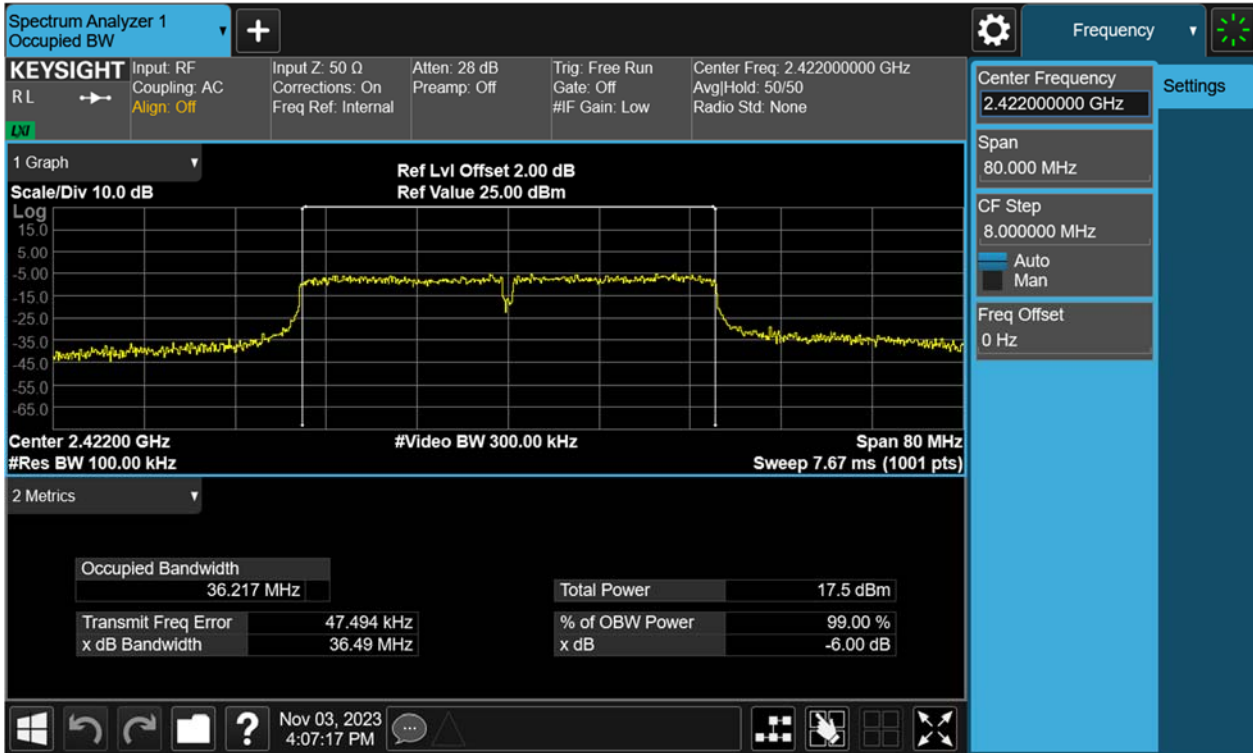

99% Bandwidth, 802.11n(HT40), 2422MHz

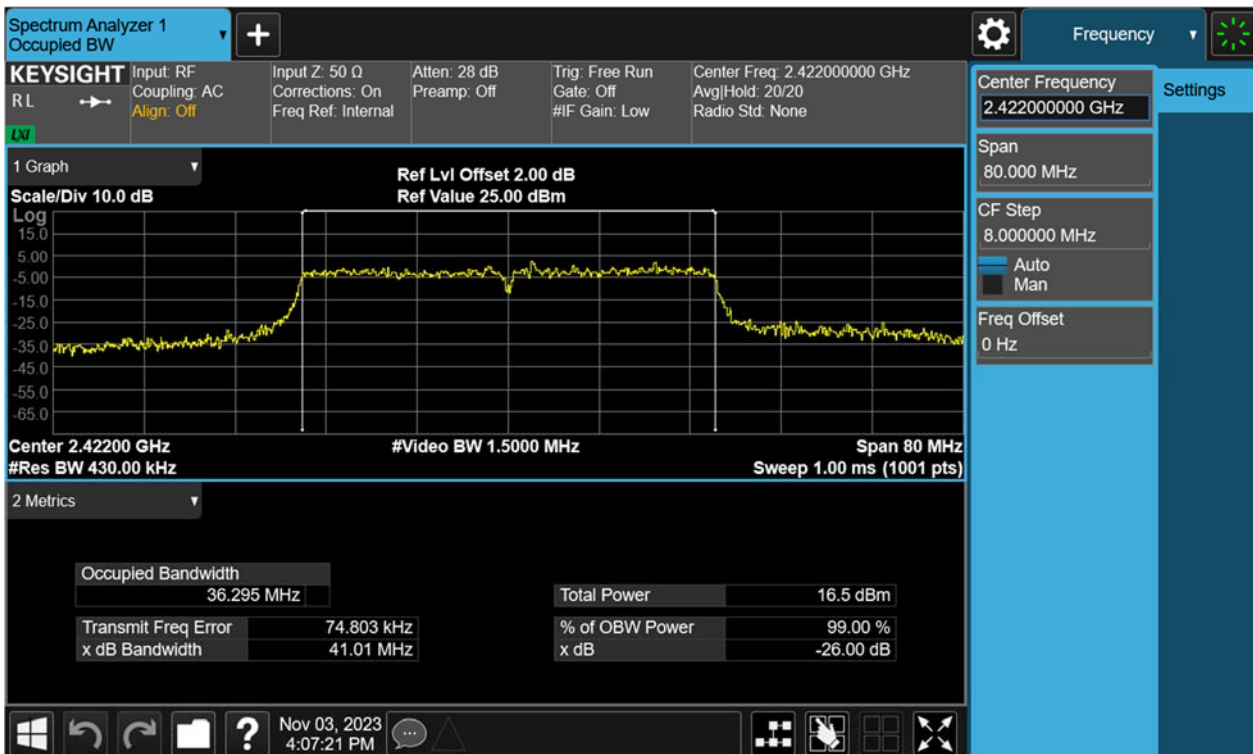

# TEST REPORT

Report No.: SHE23100101-01AE

Date: 2024-07-10

Page 24 of 65

Figure11: 6dB Bandwidth, 802.11n(HT40), 2437MHz

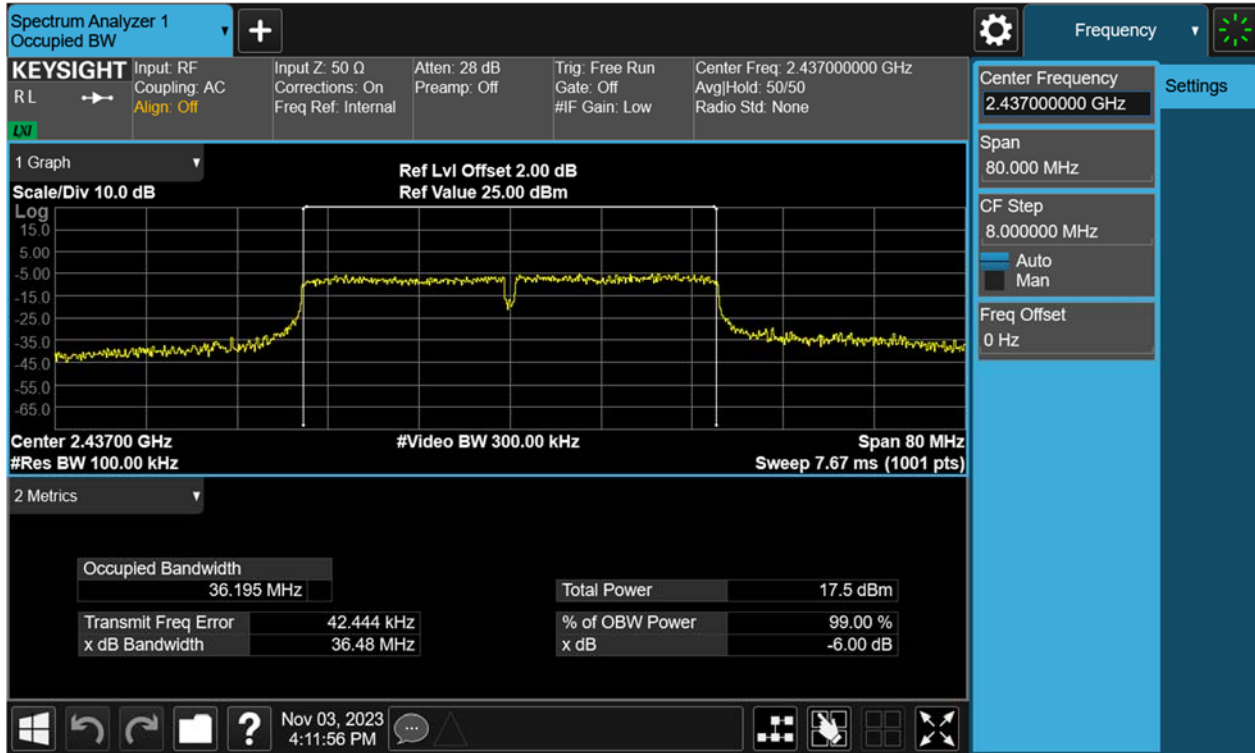

99% Bandwidth, 802.11n(HT40), 2437MHz

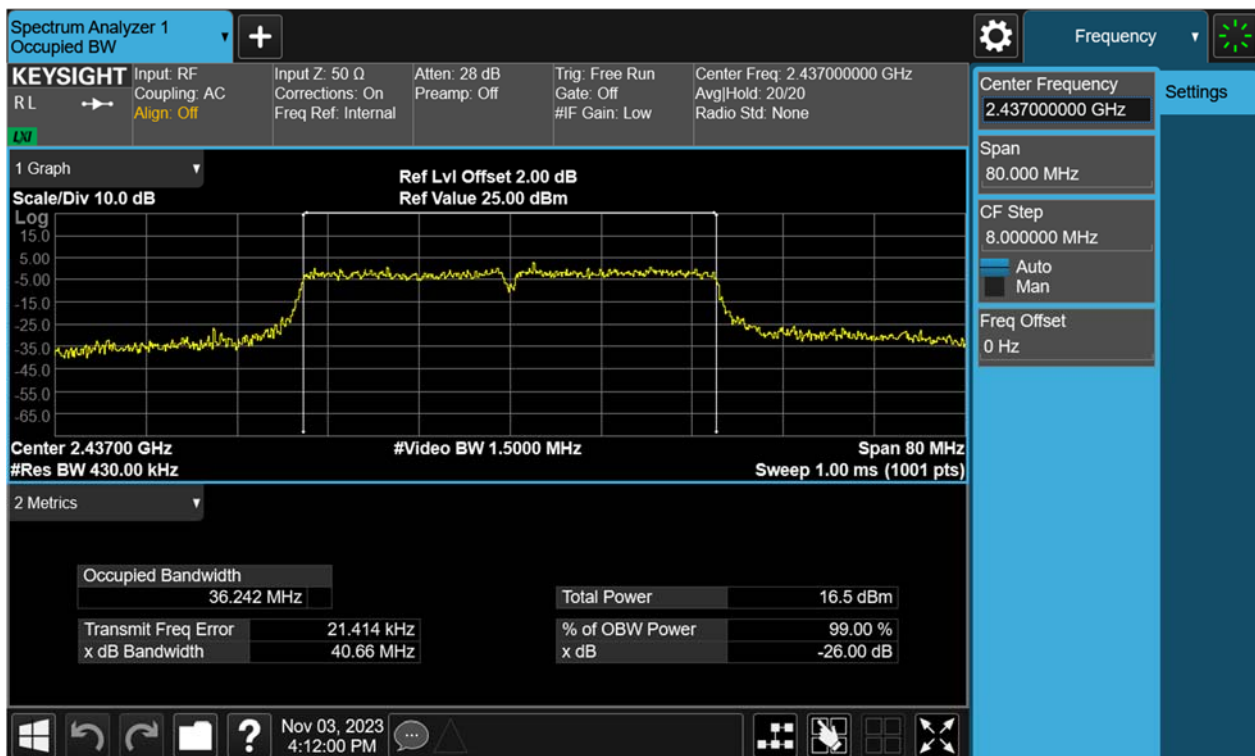



# TEST REPORT

Report No.: SHE23100101-01AE

Date: 2024-07-10

Page 25 of 65

Figure12: 6dB Bandwidth, 802.11n(HT40), 2452MHz

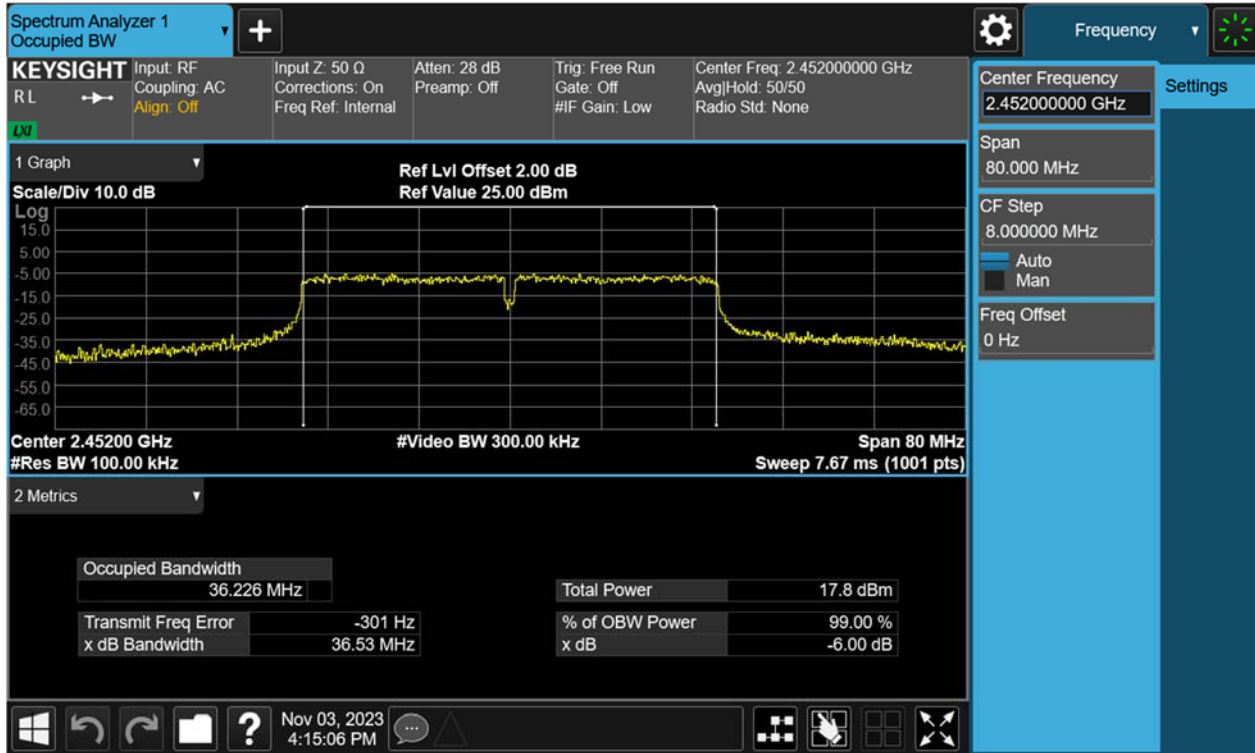

99% Bandwidth, 802.11n(HT40), 2452MHz

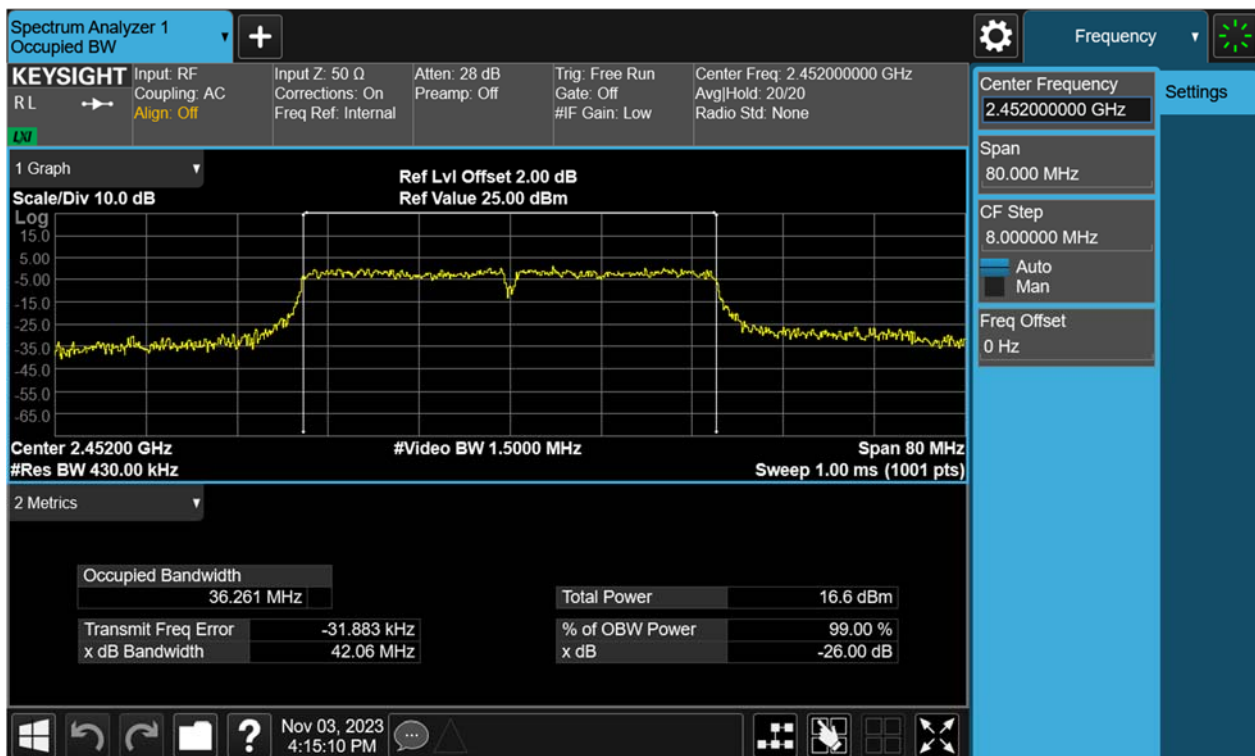

# TEST REPORT

Report No.: SHE23100101-01AE

Date: 2024-07-10

Page 26 of 65

## 4.1.4 Maximum conducted output power spectral density

RESULT:

PASS

Test standard : FCC Part 15.247(e),  
Requirement : ANSI C63.10-2013, Clause 11.10.2  
KDB 558074 D01 v05r02, Clause 8.4  
Kind of test site : Shielded room

### Test setup

Test Channel : Low/Middle/High  
Operation Mode : A.1.a  
Ambient temperature : 23.7°C  
Relative humidity : 50%

Table 3: Maximum peak conducted output power

Test Mode	Test Channel (MHz)	Maximum peak conducted output power (dBm/3kHz)	Limit (dBm/3kHz)
802.11b	2412	-19.35	≤8
	2437	-17.92	
	2462	-17.77	
802.11g	2412	-16.78	
	2437	-16.36	
	2462	-16.27	
802.11n(HT20)	2412	-16.97	
	2437	-16.71	
	2462	-16.68	
802.11n(HT40)	2422	-18.51	
	2437	-20.03	
	2452	-19.67	

# TEST REPORT

Report No.: SHE23100101-01AE

Date: 2024-07-10

Page 27 of 65

Figure 13: Power Spectral Density, 802.11b, 2412MHz

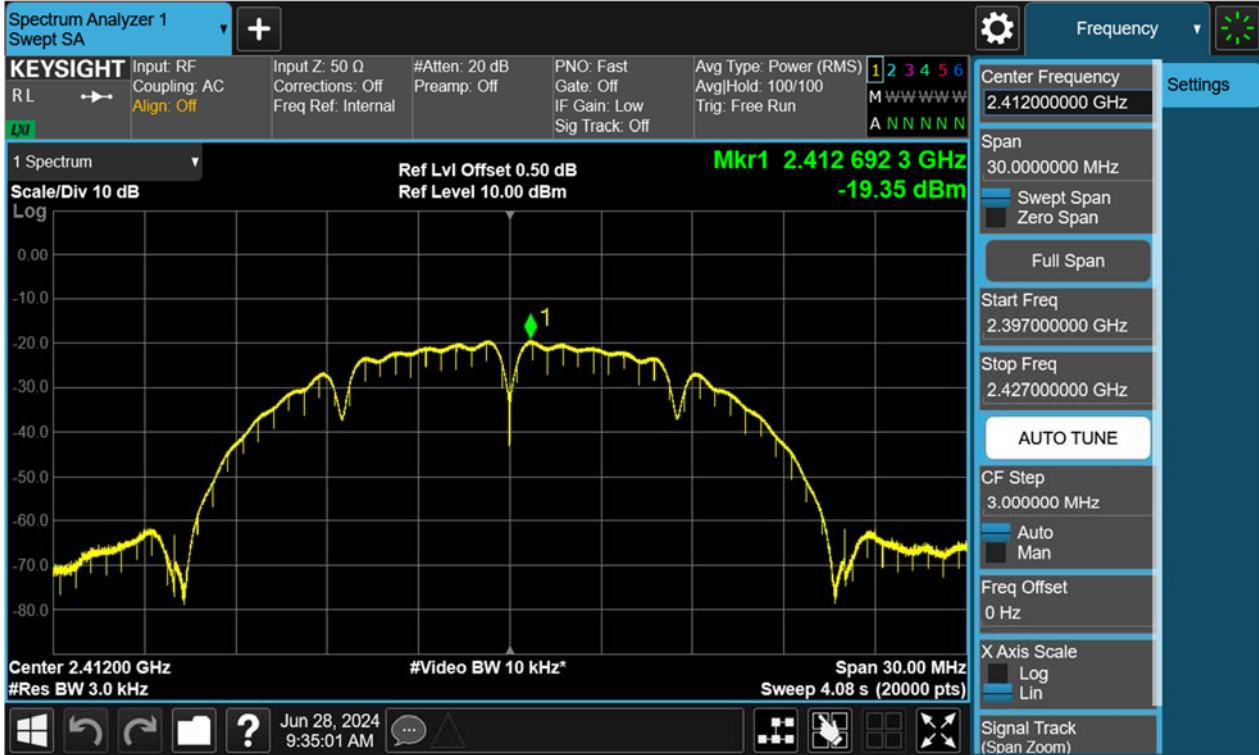

Figure 14: Power Spectral Density, 802.11b, 2437MHz



# TEST REPORT

Report No.: SHE23100101-01AE

Date: 2024-07-10

Page 28 of 65

Figure 15: Power Spectral Density, 802.11b, 2462MHz



Figure 16: Power Spectral Density, 802.11g, 2412MHz

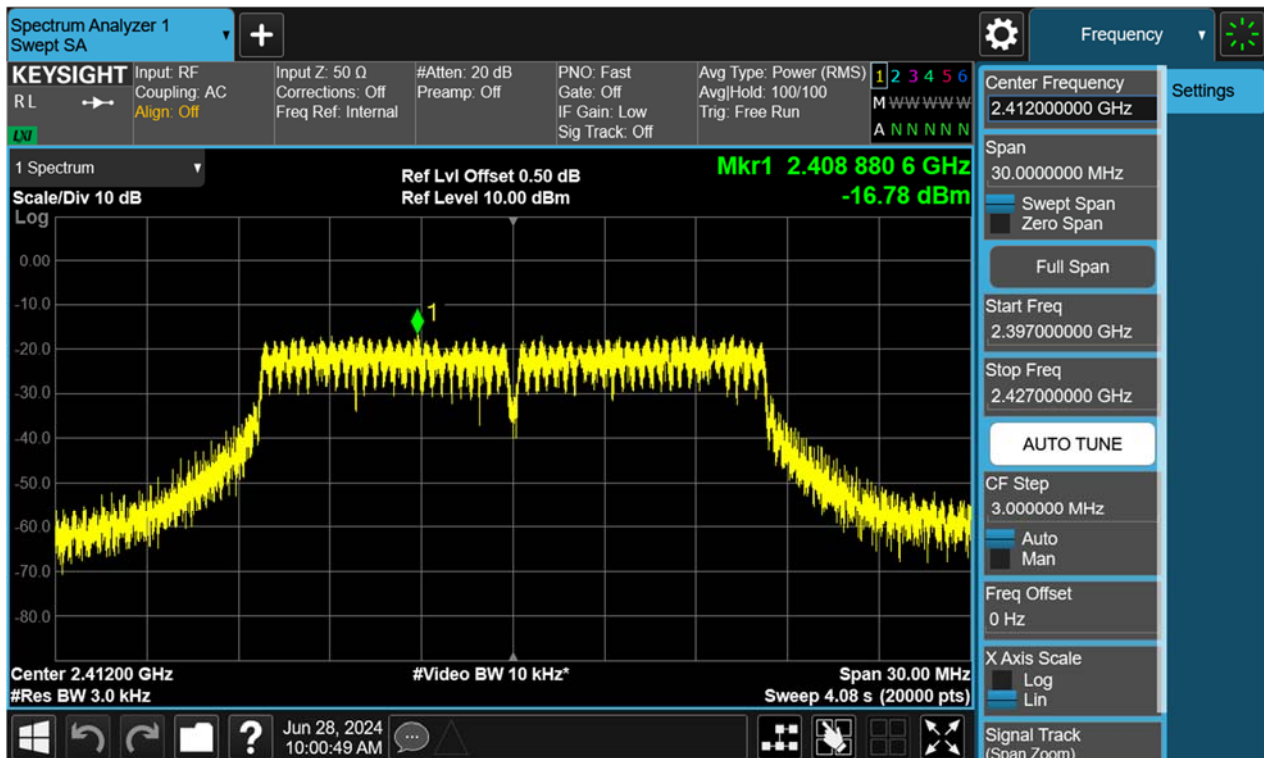

# TEST REPORT

Report No.: SHE23100101-01AE

Date: 2024-07-10

Page 29 of 65

Figure 17: Power Spectral Density, 802.11g, 2437MHz

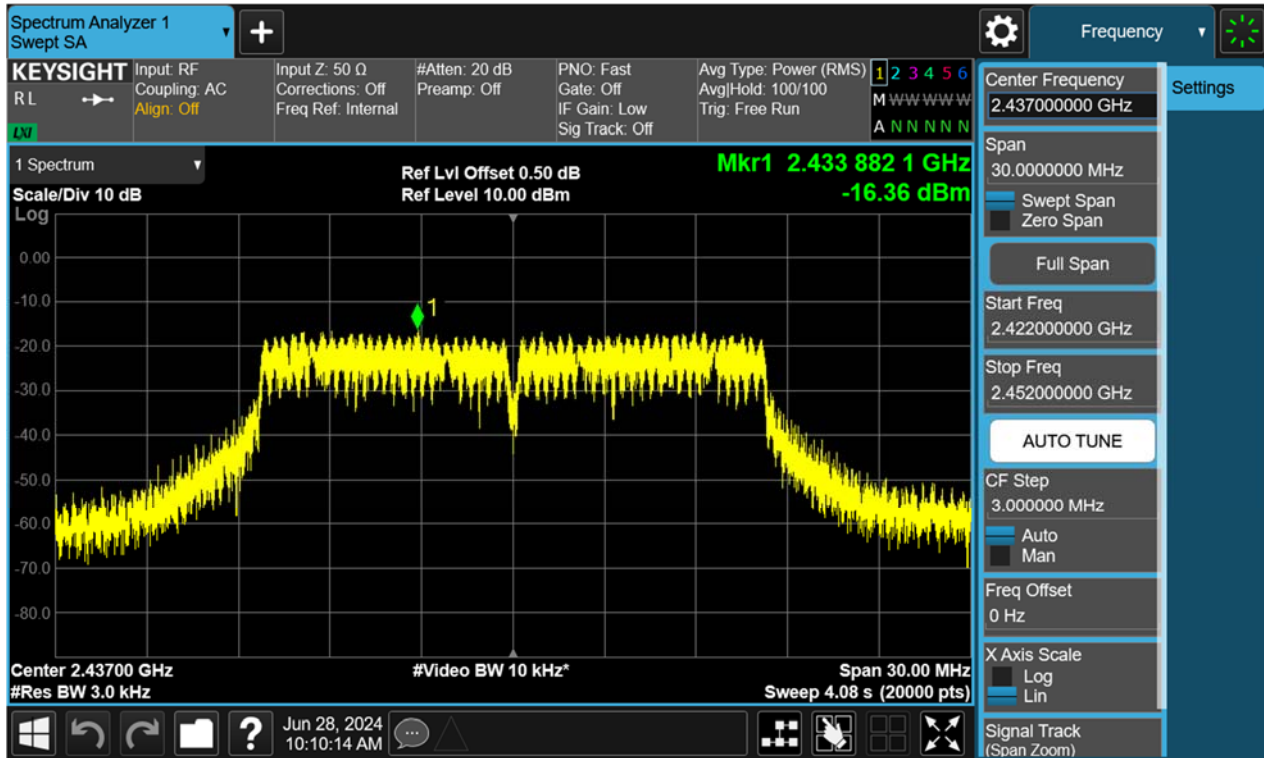
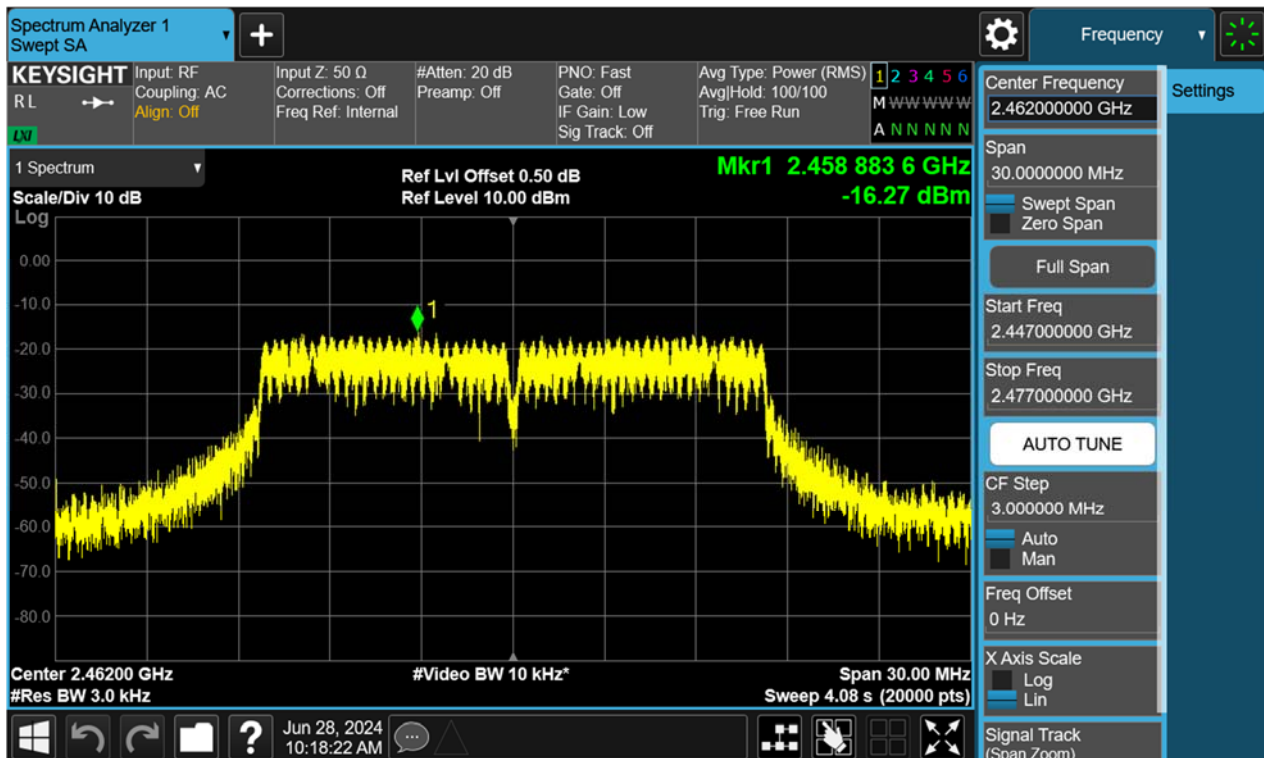

Figure 18: Power Spectral Density, 802.11g, 2462MHz



# TEST REPORT

Report No.: SHE23100101-01AE

Date: 2024-07-10

Page 30 of 65

Figure 19: Power Spectral Density, 802.11n(HT20), 2412MHz

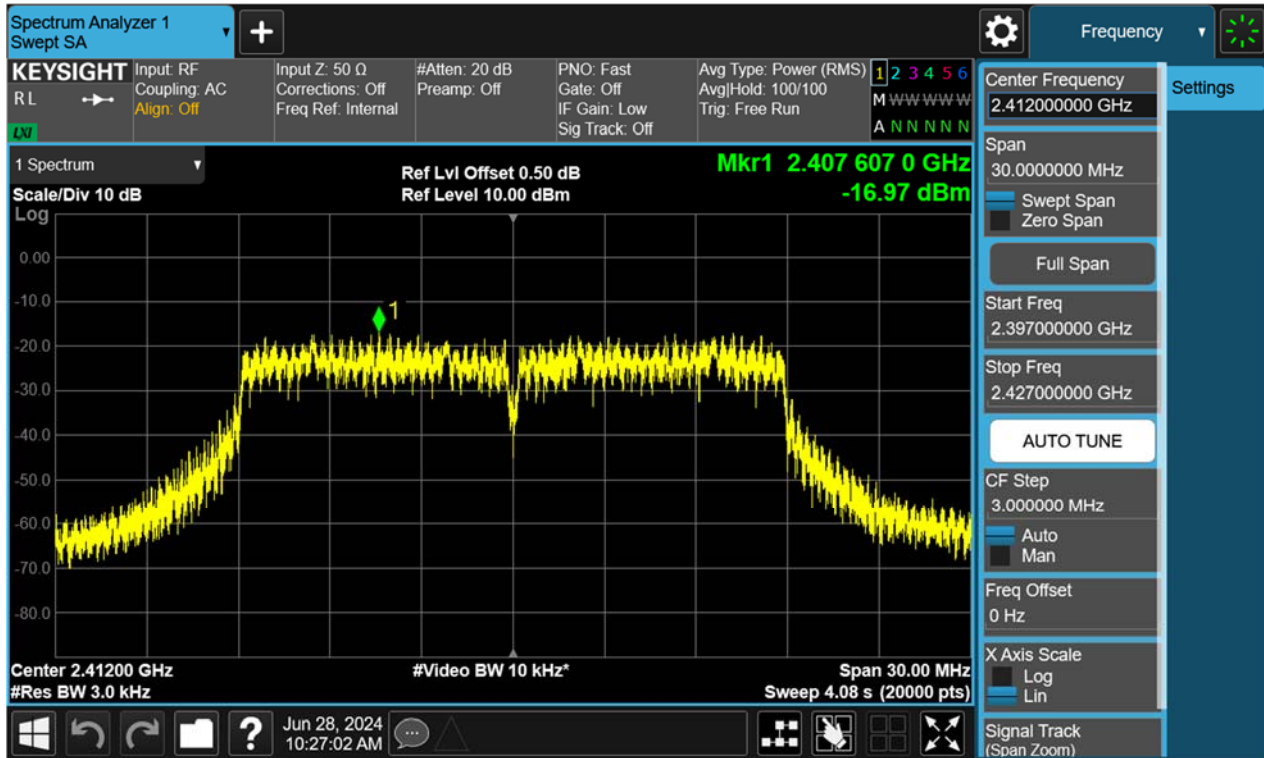
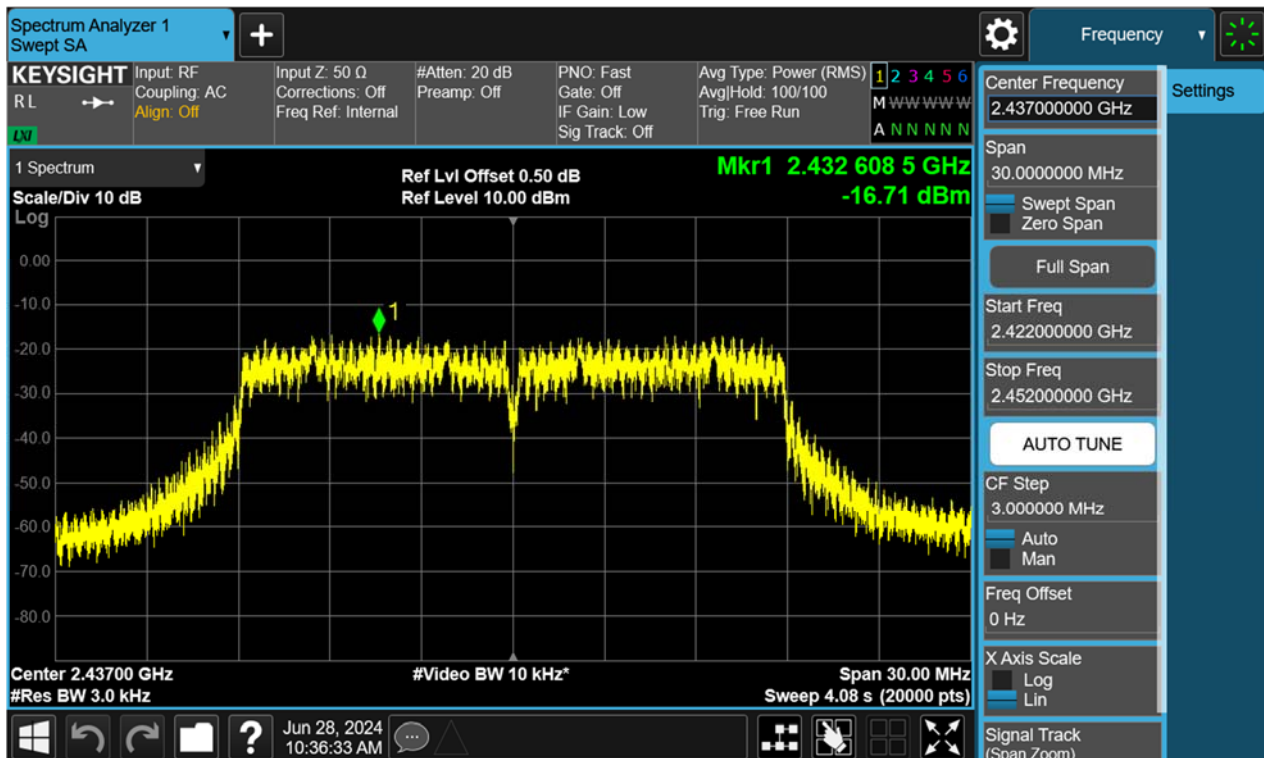

Figure 20: Power Spectral Density, 802.11n(HT20), 2437MHz



# TEST REPORT

Report No.: SHE23100101-01AE

Date: 2024-07-10

Page 31 of 65

Figure 21: Power Spectral Density, 802.11n(HT20), 2462MHz

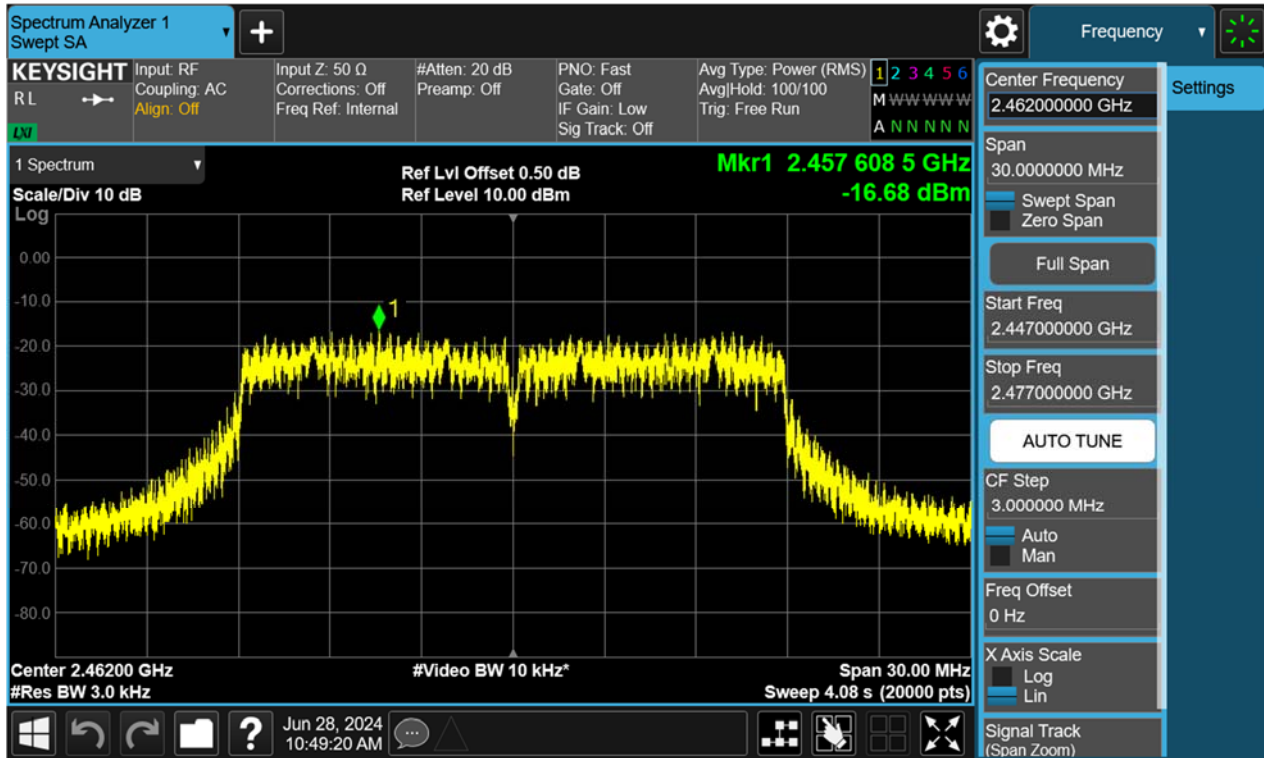
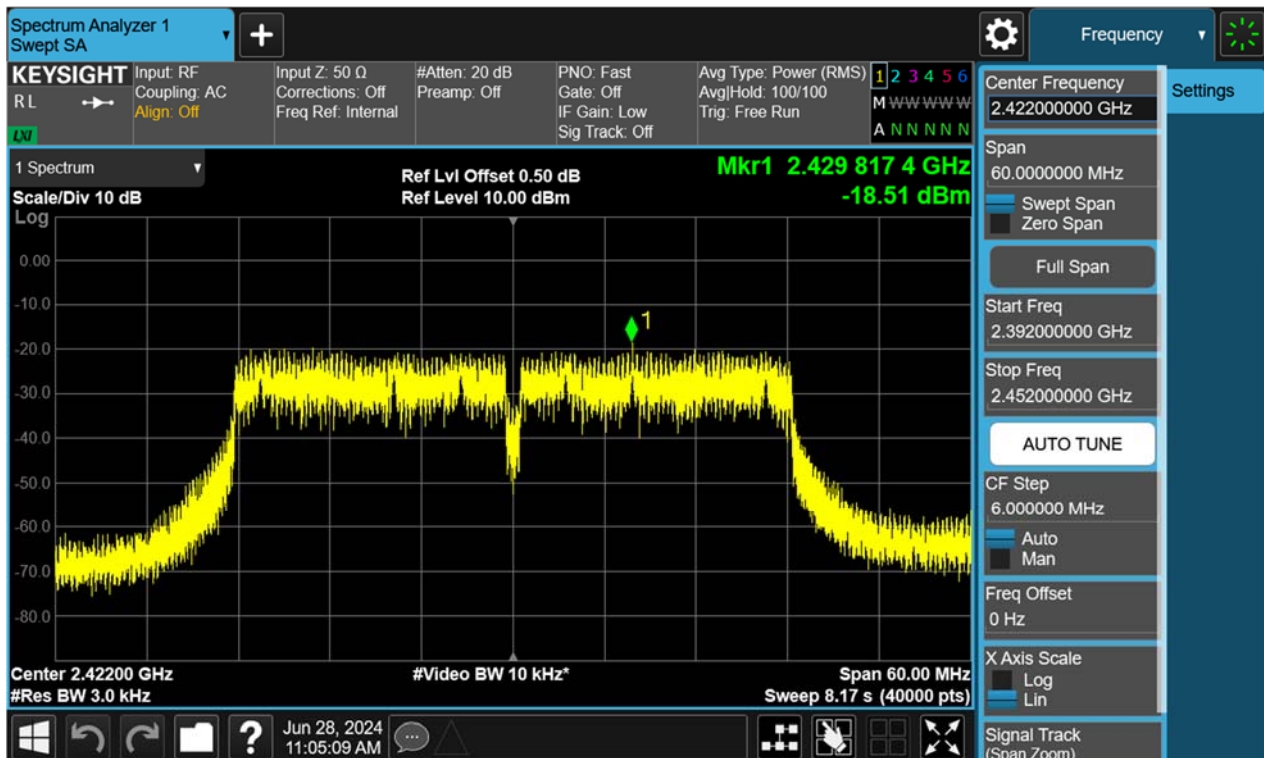

Figure 22: Power Spectral Density, 802.11n(HT40), 2422MHz



# TEST REPORT

Report No.: SHE23100101-01AE

Date: 2024-07-10

Page 32 of 65

Figure 23: Power Spectral Density, 802.11n(HT40), 2437MHz

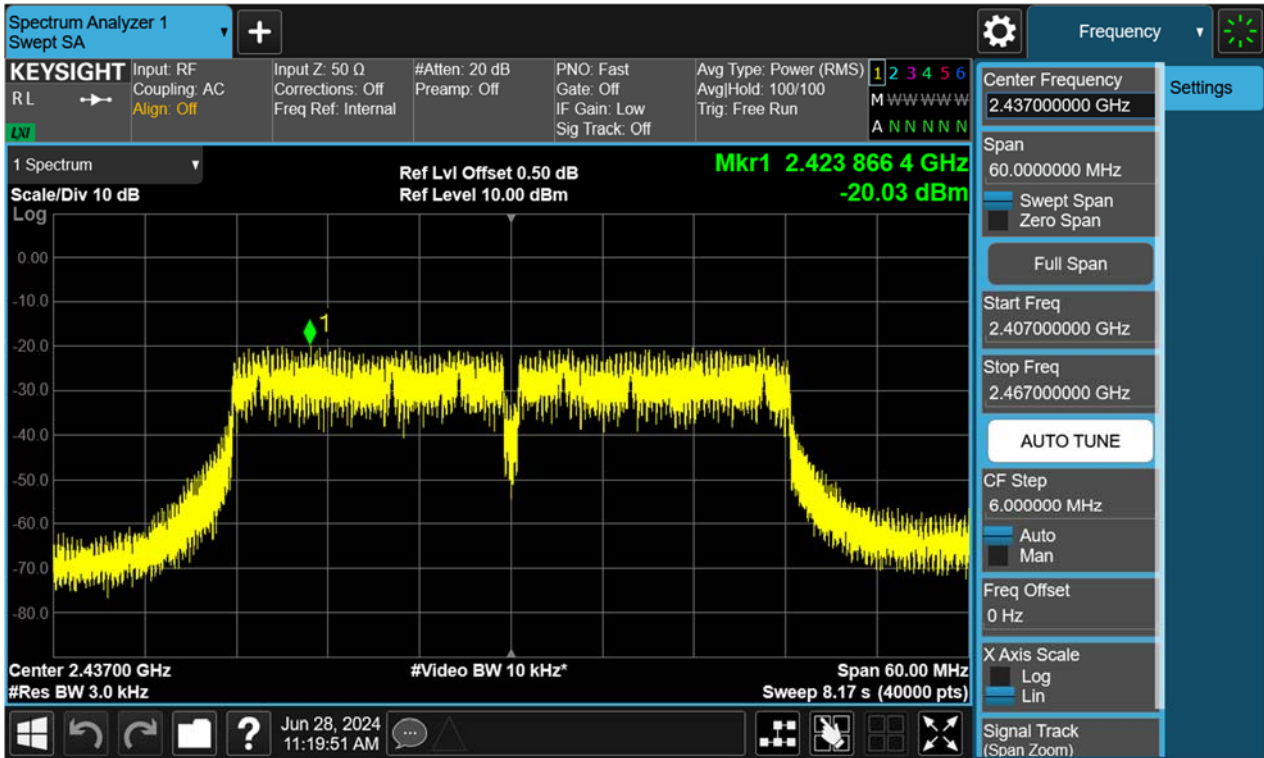
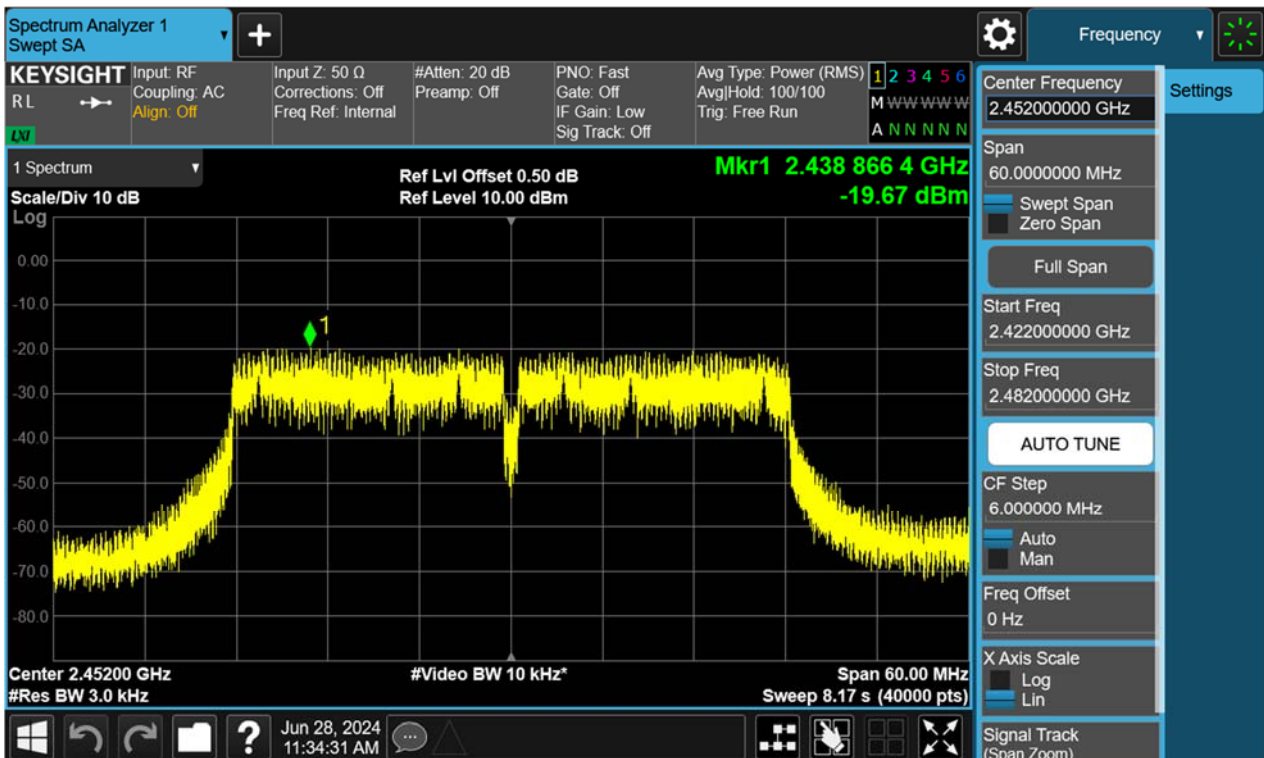

Figure 24: Power Spectral Density, 802.11n(HT40), 2452MHz





# TEST REPORT

Report No.: SHE23100101-01AE

Date: 2024-07-10

Page 33 of 65

## 4.1.5 Conducted Spurious Emission & Authorized-band band-edge

**RESULT:**

**PASS**

Test standard : FCC Part 15.247(d), 15.209  
Requirement : ANSI C63.10-2013, Clause 11.11.1(b)  
KDB 558074 D01 v05r02, Clause 8.5  
Kind of test site : Shielded room

### Test setup

Test Channel : Low/Middle/High for spurious, Low/High for Band  
Edge  
Operation Mode : A.1.a  
Ambient temperature : 22.7°C  
Relative humidity : 47%

For details refer to following test plot.

# TEST REPORT

Report No.: SHE23100101-01AE

Date: 2024-07-10

Page 34 of 65

Figure 25: Conducted Spurious Emission & Authorized-band band-edge, 802.11b, 2412MHz Carrier Level



## Band Edge

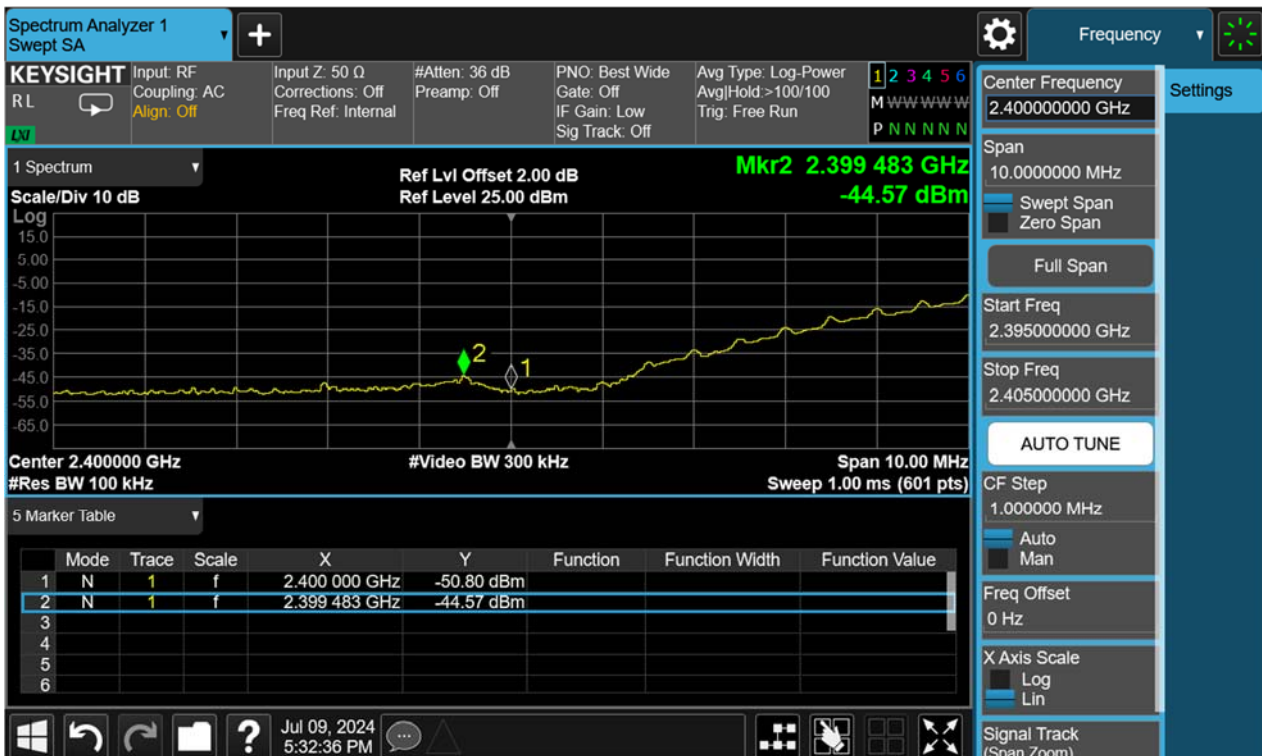

# TEST REPORT

Report No.: SHE23100101-01AE

Date: 2024-07-10

Page 35 of 65

## Conducted spurious emissions 30MHz-25GHz

