



P/N: HY160808 SRF07

Features

1. Surface mounted devices with a small dimension of $1.6 \times 0.8 \times 0.8$ mm meet future miniaturization trend.
2. Embedded and LTCC (low temperature co-fired ceramic) technology is able to integrate with system design as well as beautifying the housing of final product.
3. High stability and low tolerance.

Applications

1. Bluetooth
2. Wireless LAN
3. ISM band 2.4GHz wireless applications

Dimensions (Unit: mm)

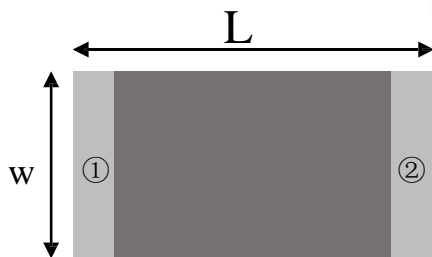

(Top View)

| Number | Terminal Name |
|--------|---------------|
| ① | INPUT |
| ② | NC |

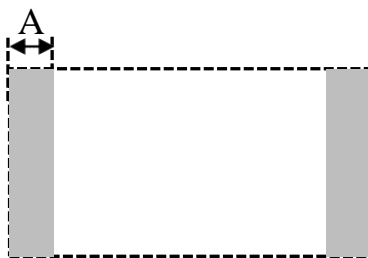

(Bottom View)

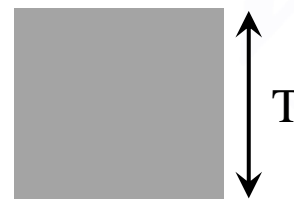

(Side View)

| Symbols | L | W | T | A |
|------------|-----------------|-----------------|-----------------|-----------------|
| Dimensions | 1.60 ± 0.20 | 0.80 ± 0.20 | 0.80 ± 0.20 | 0.30 ± 0.10 |



P/N: HY160808 SRF07

Matching Circuits

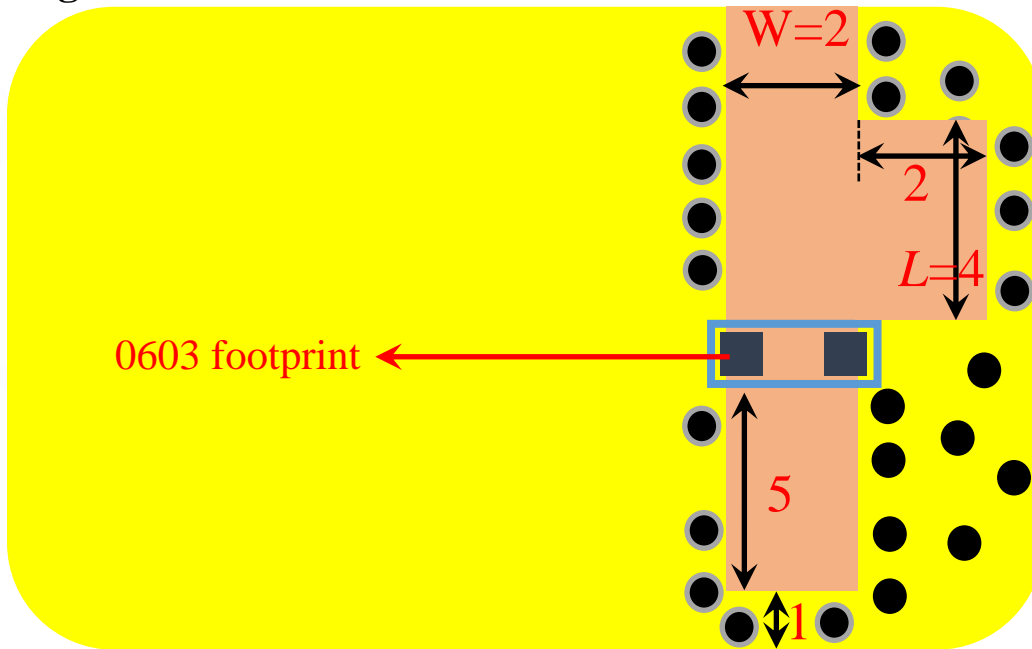

Unit:mm

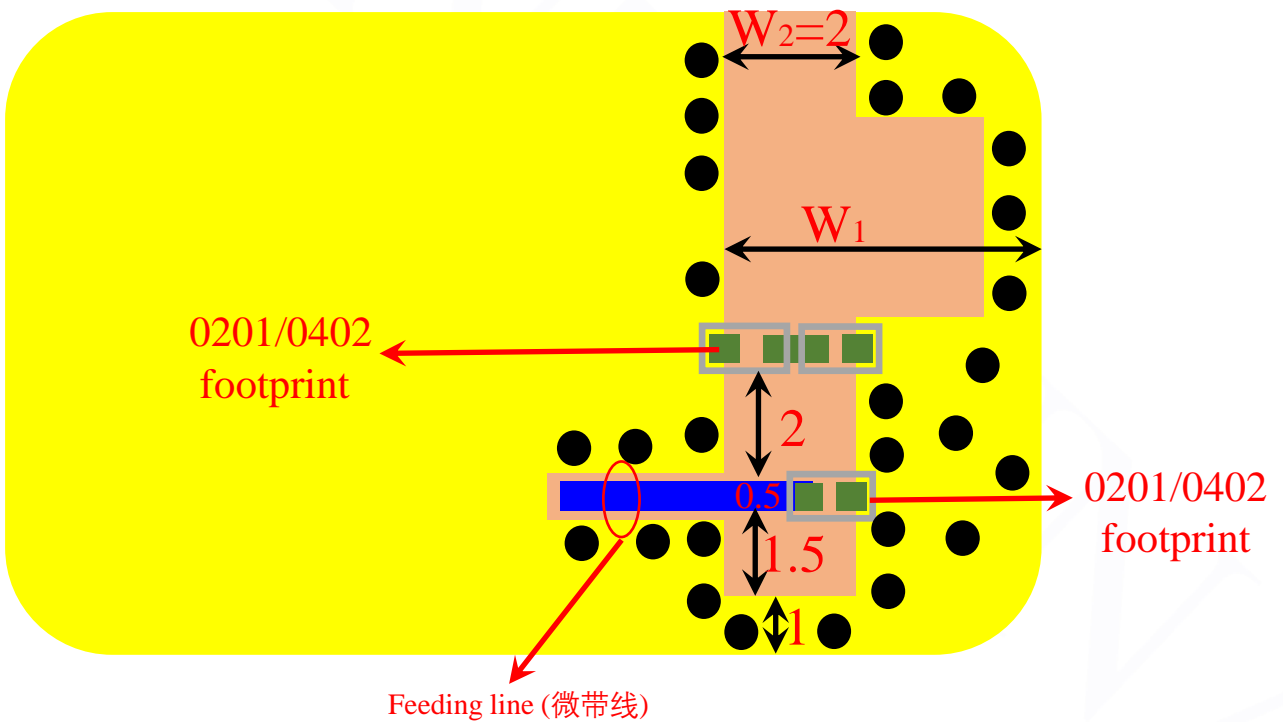

设计指导:

- 1、原则上，净空区左侧边缘距离板边的间距 W_1 应该尽量大，且注意与底部电池的间距。
- 2、主净空区的宽度 W_2 最优为1.5mm~2.5mm。
- 3、凹槽的长度 L 的长度为2mm~5mm。
- 4、0603天线和0603天线底部的两颗物料可以上下互换位置。



P/N: HY160808 SRF07

Application example-1

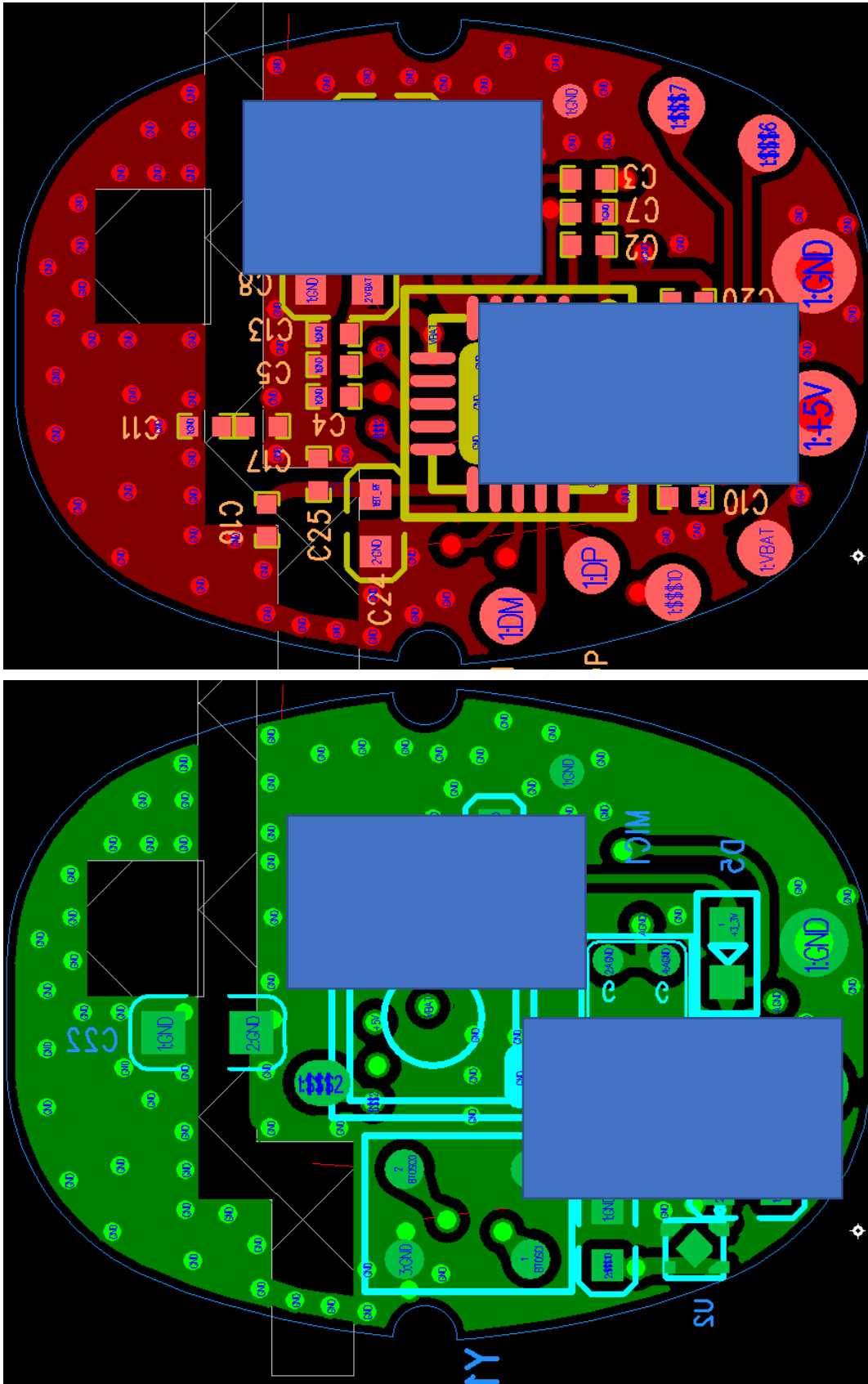

Hanyang Antenna Design Co. Ltd. has possession of proprietary information provided in this report and this proprietary information shall be kept in strict confidence and not disclosed to any person or firm without the prior written consent of Hanyang Antenna Design Co. Ltd.



P/N: HY160808 SRF07

Application example-2

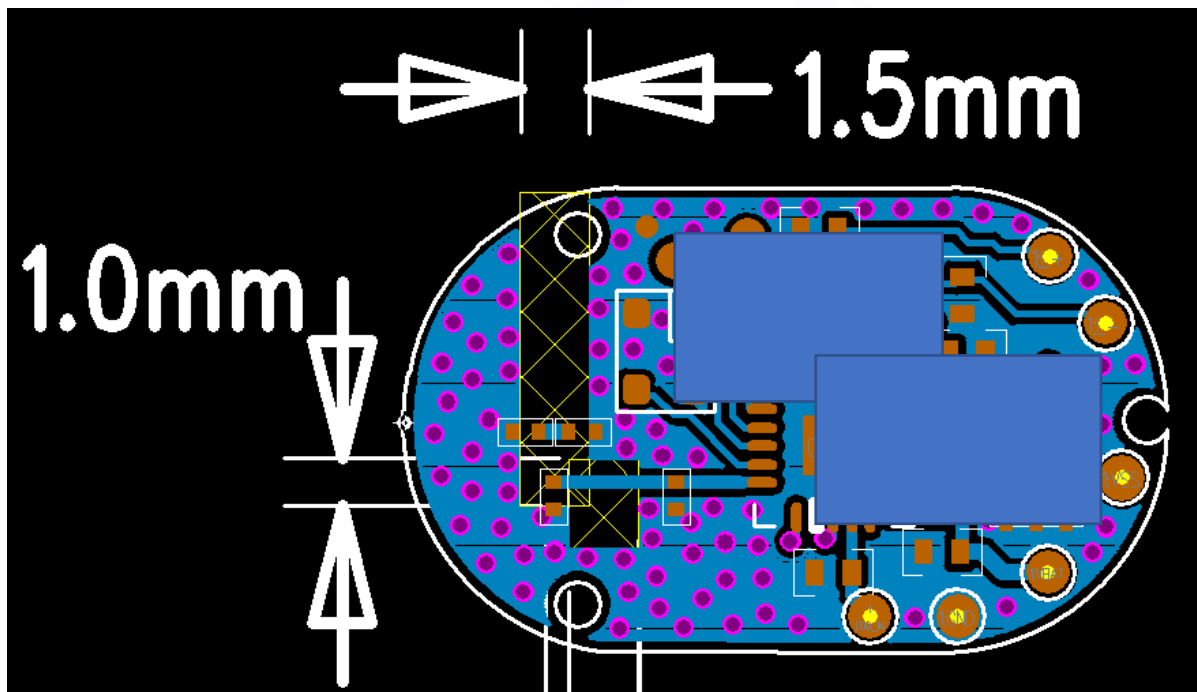
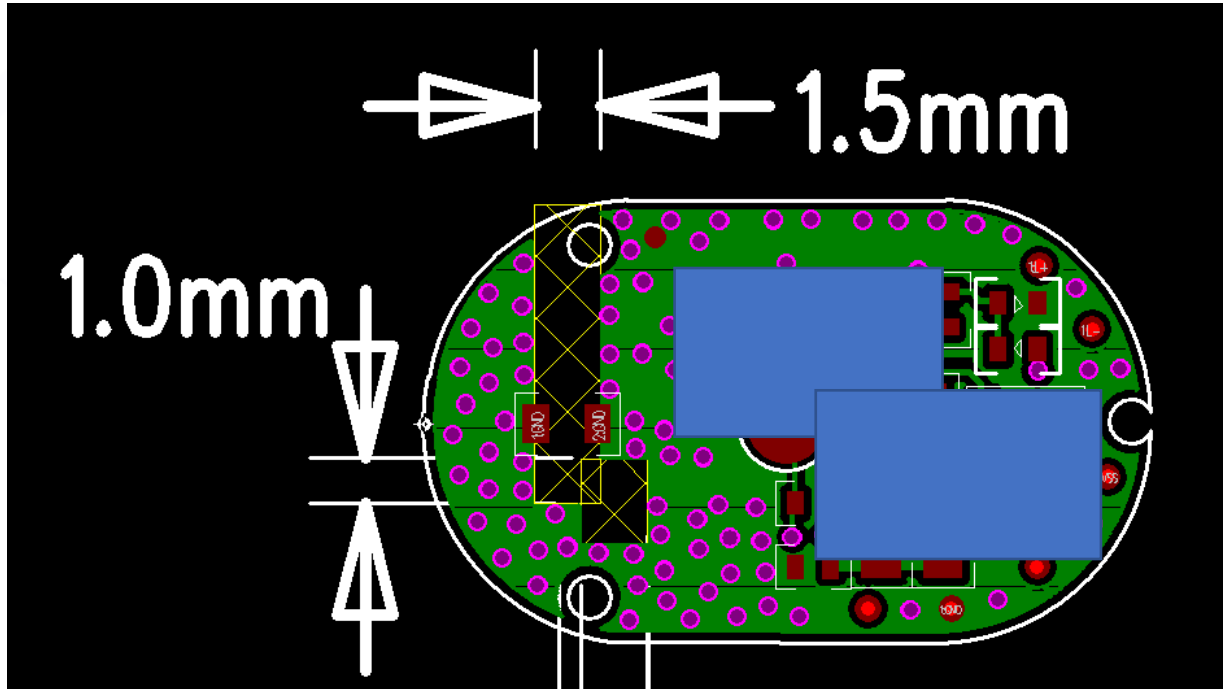



P/N: HY160808 SRF07

Electrical Characteristics

| | Feature | Specification |
|---|-------------------|-----------------|
| 1 | Central frequency | 2.45GHz |
| 2 | Bandwidth | >100MHz |
| 3 | Peak gain | 3dBi |
| 4 | VSWR | <2 |
| 5 | Polarization | Linear |
| 6 | Azimuth beamwidth | Omnidirectional |
| 7 | Impedance | 50 Ω |

Characteristic Curves

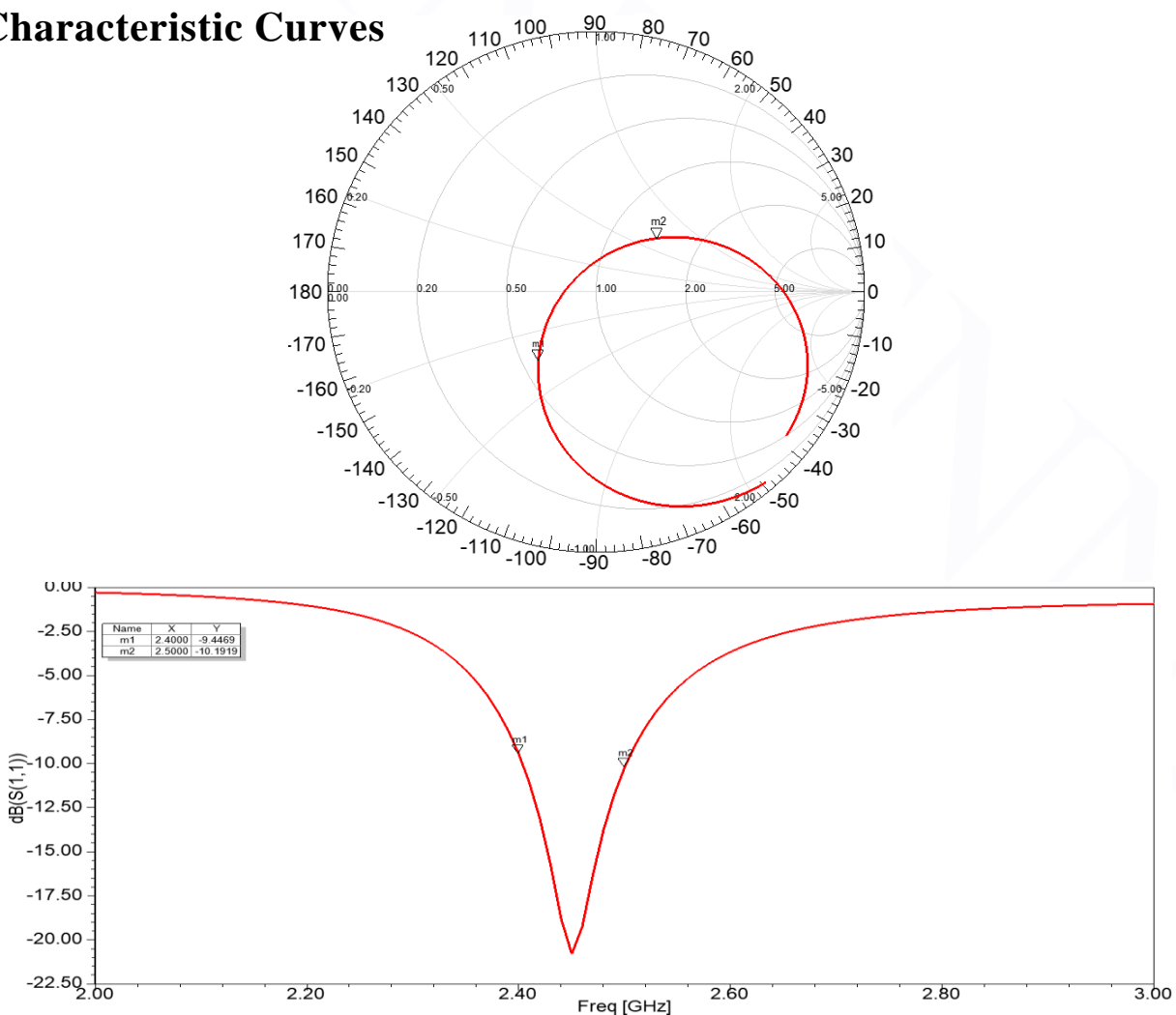

Hanyang Antenna Design Co. Ltd. has possession of proprietary information provided in this report and this proprietary information shall be kept in strict confidence and not disclosed to any person or firm without the prior written consent of Hanyang Antenna Design Co. Ltd.



P/N: HY160808 SRF07

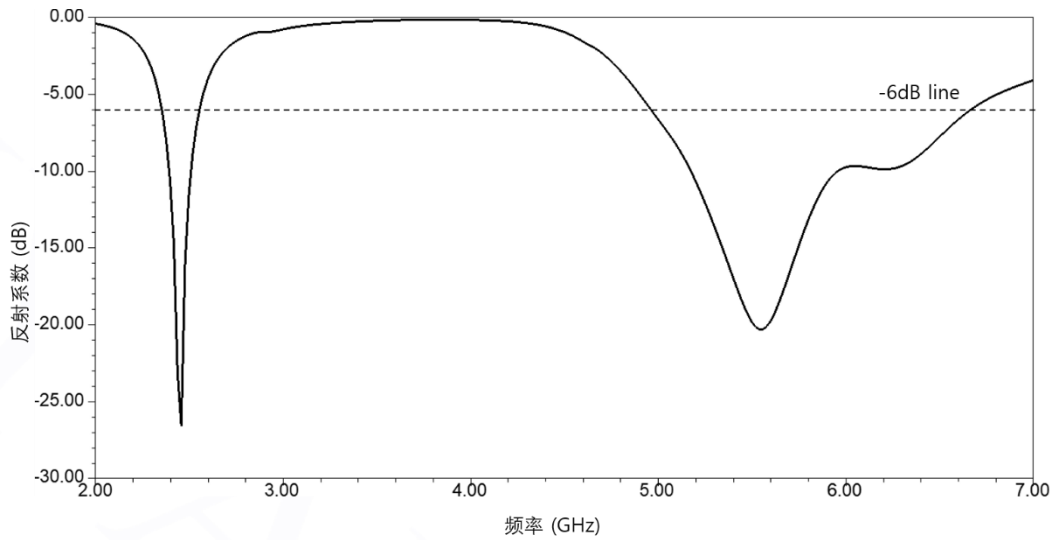

Radiation Pattern

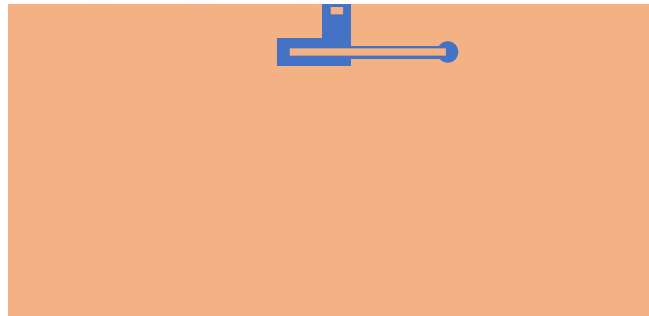
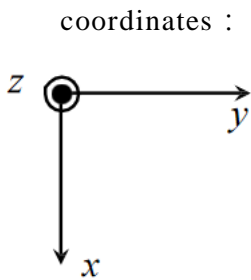

Y-Z Plane

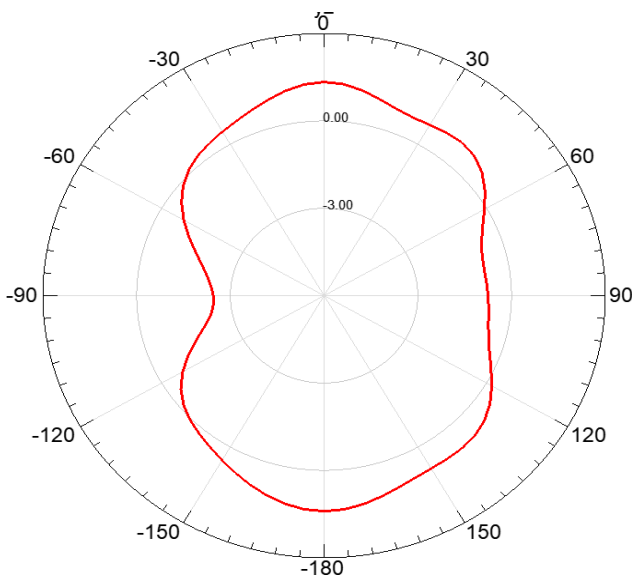

X-Z Plane

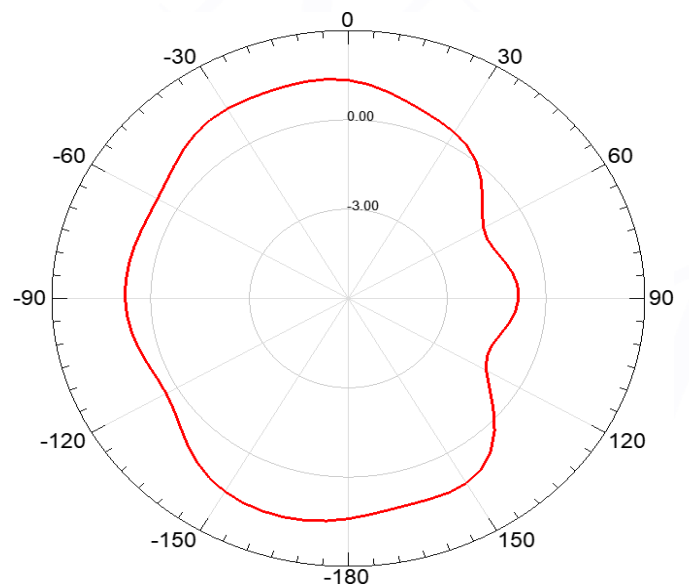

Hanyang Antenna Design Co. Ltd. has possession of proprietary information provided in this report and this proprietary information shall be kept in strict confidence and not disclosed to any person or firm without the prior written consent of Hanyang Antenna Design Co. Ltd.



P/N: HY160808 SRF07

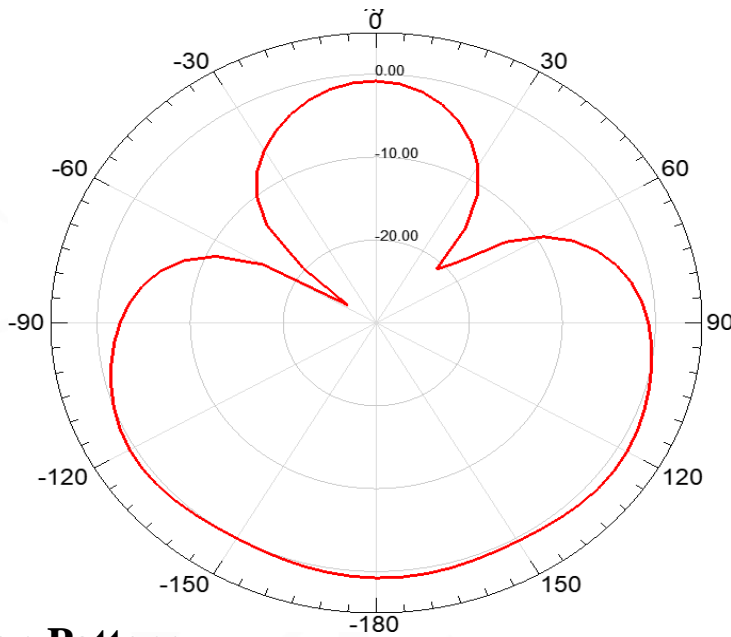

3D Radiation Pattern

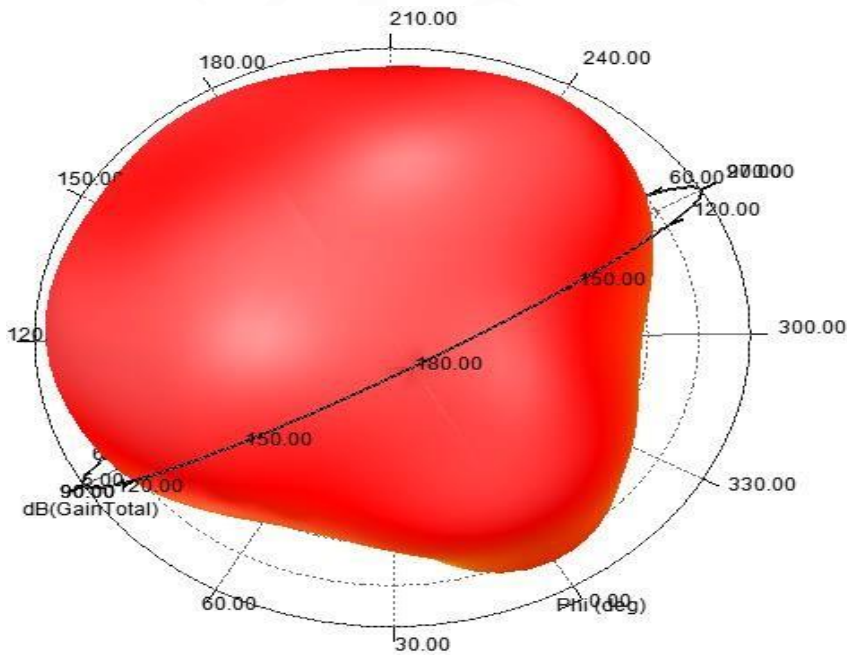

| Frequency | 2450MHz |
|------------|---------|
| Avg. gain | -0.85 |
| Peak gain | 3.0 |
| Efficiency | 82% |

Hanyang Antenna Design Co. Ltd. has possession of proprietary information provided in this report and this proprietary information shall be kept in strict confidence and not disclosed to any person or firm without the prior written consent of Hanyang Antenna Design Co. Ltd.



P/N: HY160808 SRF07

Dependability Test

| | |
|-----------------------|---------------|
| Test Temperature | 25°C ± 3°C |
| Operating Temperature | -25°C ~ +85°C |
| Temperature | 5~40°C |
| Relative Humidity | 20~70% |

Moisture Proof

Temperature: 40 ± 2°C Humidity: 90~95%RH
Duration: 500h
Recovery conditions: Room temperature Recovery Time: 24h (Class1) or 48h (Class2)

Solderability

At least 95% of the terminal electrode is covered by new solder.
Preheating conditions: 80 to 120°C; 10~30s.
Solder Temperature: 235 ± 5°C Duration: 2 ± 0.5s, Solder Temperature: 245 ± 5°C Duration: 2 ± 0.5s

Optimum Solder Amount for Reflow Soldering

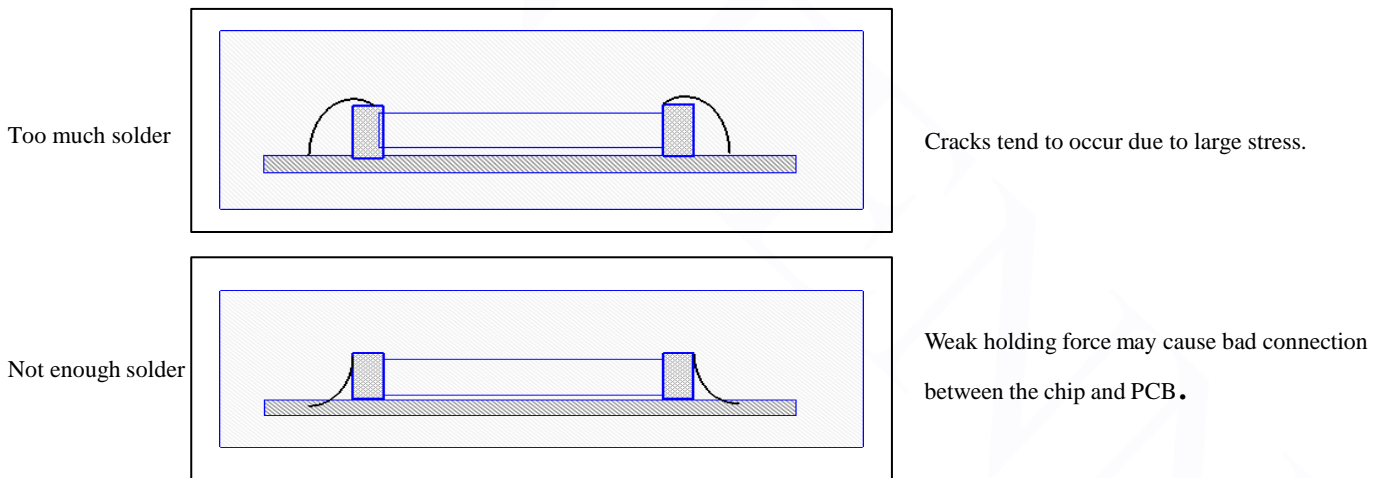

Recommended Soldering Amounts

The optimal solder fillet amounts for re-flow soldering

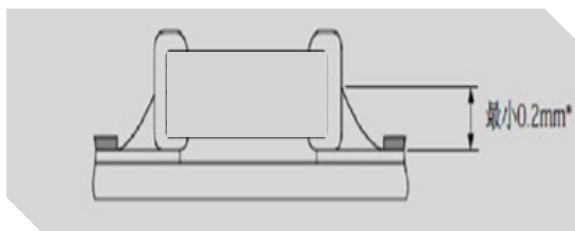

The optimal solder fillet amounts for wave soldering

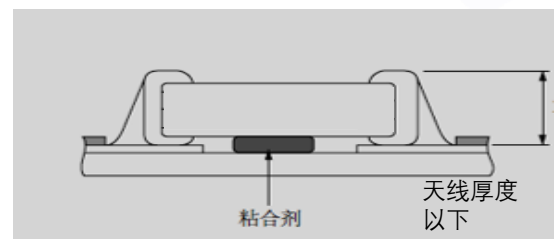

Hanyang Antenna Design Co. Ltd. has possession of proprietary information provided in this report and this proprietary information shall be kept in strict confidence and not disclosed to any person or firm without the prior written consent of Hanyang Antenna Design Co. Ltd.



P/N: HY160808 SRF07

Temperature Cycle Test

10±1S Applied Force: 5N Duration: 10±1S
Preheating conditions: up-category temperature, 1h
Recovery time: 24±1h
Initial Measurement
Cycling Times: 5 times, 1 cycle, 4 steps:

| 阶段 | 温度 (°C) | 时间 (分钟) |
|-----|--|---------|
| 第1步 | 下限温度 ^(NPO/X7R/X7S/X6S/X5R-55) _{Y5V-25 Z5U-10} | 30 |
| 第2步 | 常温 (+20) | 2~3 |
| 第3步 | 上限温度 ^(NPO/X7R/X7S-125) _{Y5V/Z5U/X5R-85 X6S-105} | 30 |
| 第4步 | 常温 (+20) | 2~3 |

Resistance to Soldering Heat

Preheating 80 to 120°C; 10~30s. Solder Temperature: 235±5°C; Duration: 2±0.5s; Solder Temperature: 245±5°C
Duration: 2±0.5s; Preheating 100 to 200°C; 10±2min.
Solder Temperature: 265±5°C; Duration: 10±1s
Clean the capacitor with solvent and examine it with a 10X(min.) microscope.
Recovery Time: 24±2h
Recovery condition: Room temperature

Resistance to Flexure of Substrate

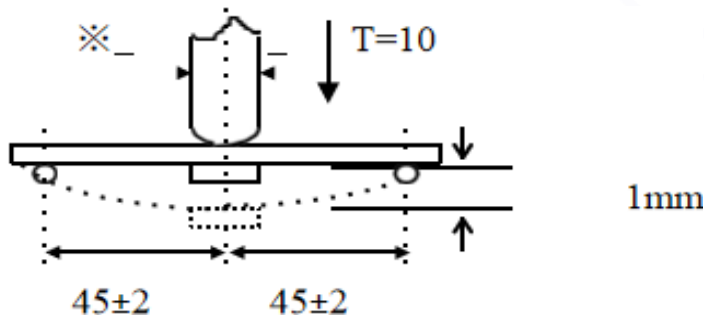

Test Board: Al₂O₃ or PCB Warp: 1mm Speed: 0.5mm/sec.
Unit: mm

The measurement should be made with the board in the bending position.



P/N: HY160808 SRF07

The temperature profile for soldering

Re-flow soldering

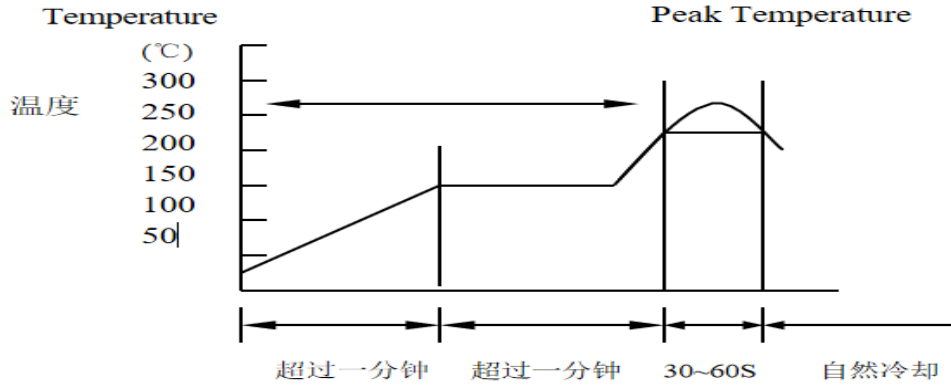

| | Pb-Sn 焊接 Pb-Sn soldering | 无铅焊接 Lead-free soldering |
|--------------------------|-----------------------------|-----------------------------|
| 尖峰温度 Peak temperature | 230°C~250°C | 240°C~260°C |

While in preheating, please keep the temperature difference between soldering temperature and surface temperature of chips as: $T \leq 150^\circ\text{C}$.

Wave soldering

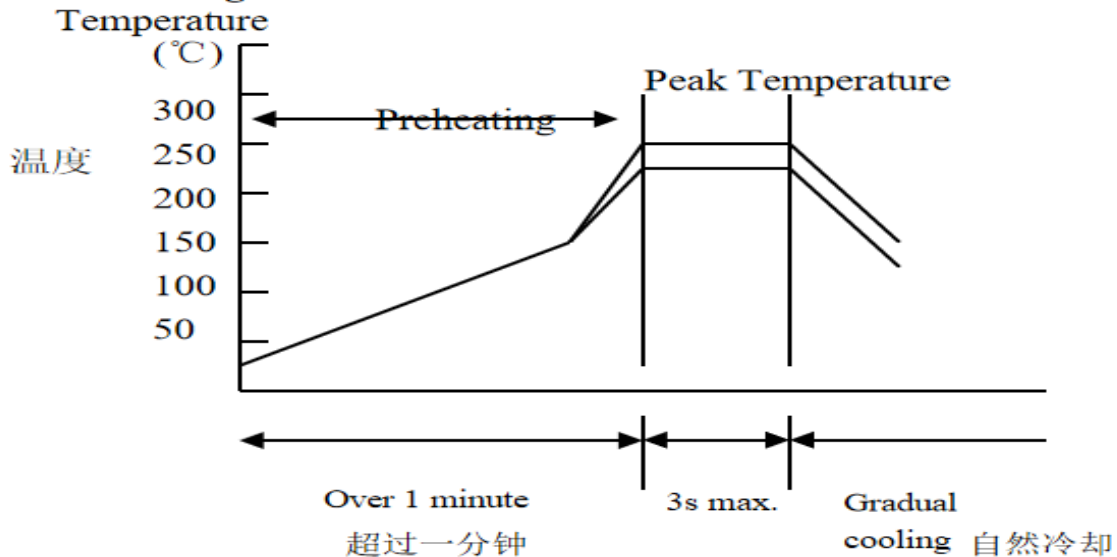

| | Pb-Sn 焊接 Pb-Sn soldering | 无铅焊接 Lead-free soldering |
|--------------------------|-----------------------------|-----------------------------|
| 尖峰温度 Peak temperature | 230°C~260°C | 240°C~270°C |



P/N: HY160808 SRF07

Dimensions of paper taping

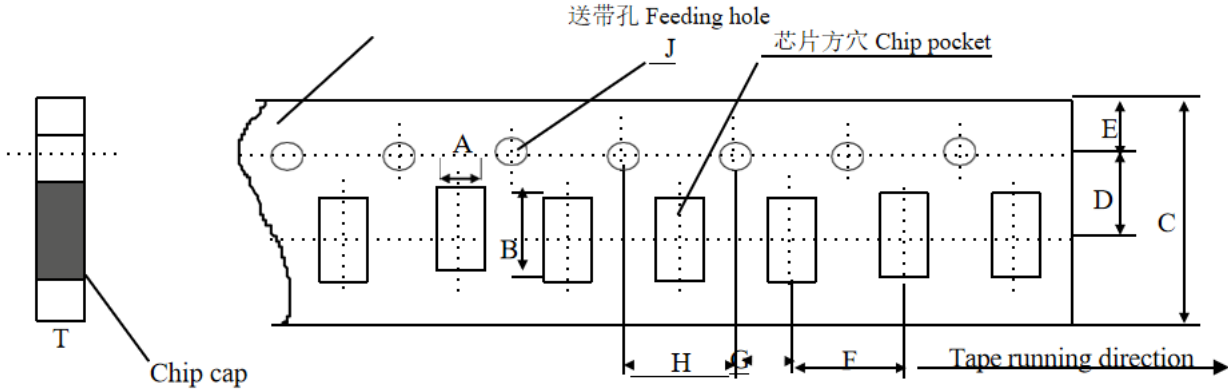

Unit: mm

| 代号 Code 纸带规格 papersize | A | B | C | D* | E | F | G* | H | J | T |
|------------------------------|---------------|---------------|---------------|---------------|---------------|---------------|---------------|---------------|------------------|-------------|
| 尺寸 | 1.10 ±0.10 | 1.90 ±0.10 | 8.00 ±0.10 | 3.50 ±0.05 | 1.75 ±0.10 | 4.00 ±0.10 | 2.00 ±0.10 | 4.00 ±0.10 | 1.50 -0/+0.10 | 1.10 Max |

Reel (4000 pcs/Reel)

EMBOSED TAPING

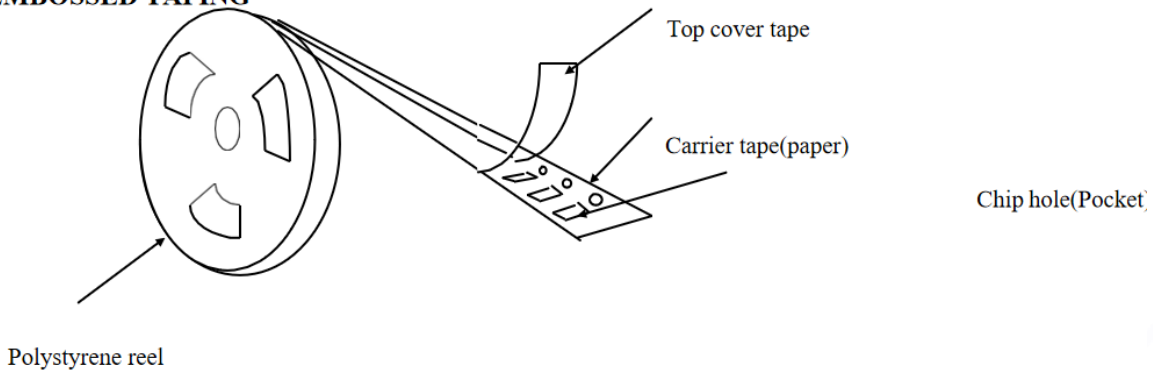

Storage Period

The guaranteed period for solderability is 6 months (Under deliver package condition).
Temperature: 5~40°C /Relative Humidity: 20~70%

Hanyang Antenna Design Co. Ltd. has possession of proprietary information provided in this report and this proprietary information shall be kept in strict confidence and not disclosed to any person or firm without the prior written consent of Hanyang Antenna Design Co. Ltd.