

QHD CAR DASHCAM

This product adopts high performance chipset to provide high definition video with seamless motion picture. It has passed the strict certification of CE and FCC, supports FHD 1080P and 2K QHD video recording. Please read this manual carefully before use and keep it in a safe place, we hope this product can meet your needs and serve you for a long time!

I . Appearance and Button description

(Following pictures are for reference only, please check the real product)

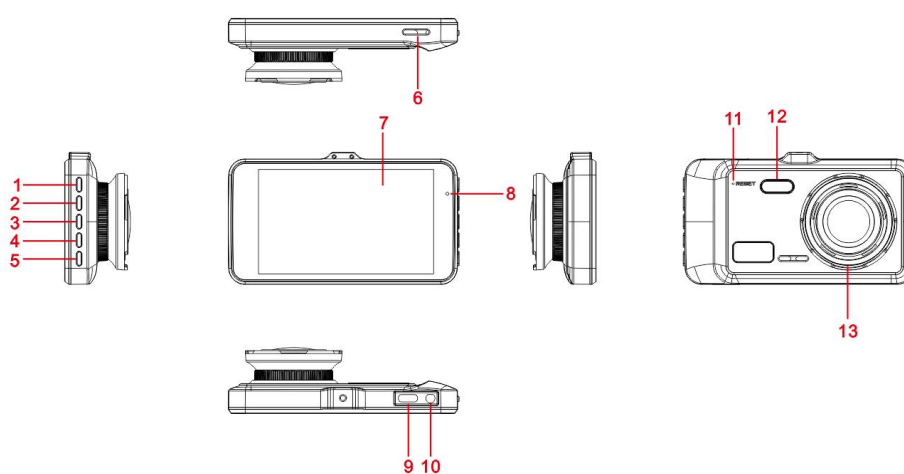

- | | | |
|--------------------|--------------------|--------------------|
| 1. Mode | 2. UP/ MIC | 3. Power/OK button |
| 4. Down | 5. Menu | 6. TF slot |
| 7. Touch panel | 8. Indicator light | 9. Type-C port |
| 10. Back lens port | 11. Reset | 12. LED |
| 13. Front lens | | |

Power/OK button

1. Switch On/Off

In the off state, long press [Power/OK button] for 3 seconds to turn on the power of the dashcam, it will start recording video automatically.

In the power on state, long press [Power/OK button] for 3 seconds to shut down, it will save the video file and settings automatically.

2. Turn off the screen

In the power on state, press [Power/OK button] to turn off the screen, press again to turn on the screen.

3. In the system interface, press[Power/OK button] to confirm settings

Up

- 1> In the playback interface, short press to switch the video file
- 2> In the video preview, short press to switch the front and rear lens interface
- 3> In the system setting interface, short press to switch the setting
- 4> Long press to turn on / off WIFI

Down

1. In the playback interface, short press to switch video file
2. In the video preview, short press to turn on /off video voice

Menu

1. Short press to open menu

Mode

1. Short press to start taking photos
2. Long press to enter the playback interface

II. Function interface

Recording video

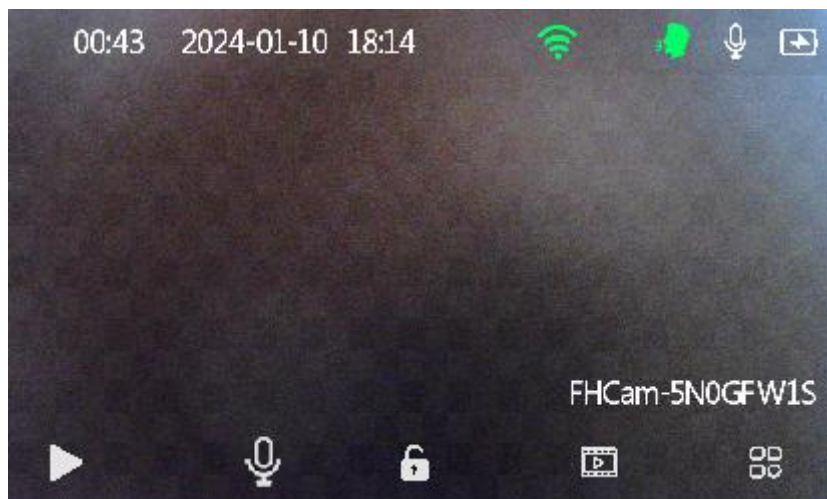

System settings

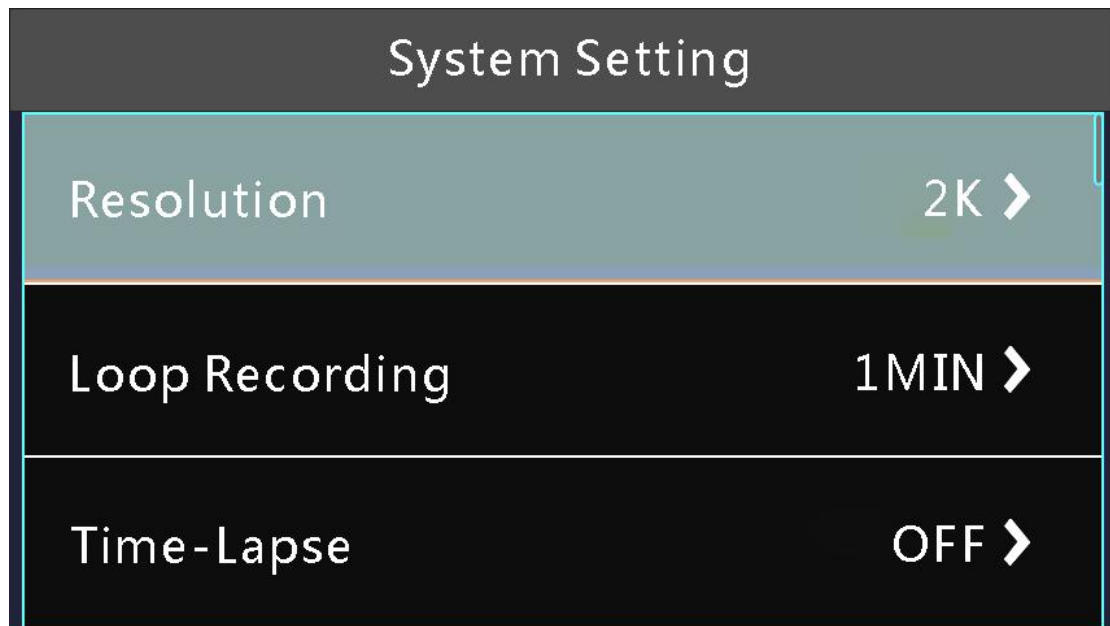

- Resolution: 2K, 1080P
- Loop Recording: 1 Mins, 2 Mins, 3 Mins
- Time - Lapse: Off, 1 Second, 2 Seconds, 3 Seconds
- Time - Lapse time: Off, 12 Hours, 24 Hours, 48 Hours
- Video voice: Off, On
- G-sensor: Off, Low, Medium, High
- Parking mode: Off, Low, Medium, High
- Time stamp: Off, On
- Mirroring of back lens: Off, Preview mirror
- Plate number: Off, On
- Screen save: Off, 10 Seconds, 30 Seconds, 60 Seconds
- Button sound: Off, On
- Speaker volume: Off, Low, Medium, High
- Switch on / off sound: On, Off
- Language: Chinese Simplified, Chinese Traditional and others
- Time setting: System time setting
- Voice recognition: Off, On

Voice recognition include : Turn on screen, turn off screen, take picture, turn on voice, turn off voice, open the front lens, open the back lens, open all the lens lock the video, turn on hotspot, turn off hotspot.

- Mobile phone interconnection: Off, On

- Format: Confirm, Cancel









Note: Formatting will delete all the files (including locked files) in the memory card, after formatting , the files will not be recoverable, please copy important files before format.

- Restore factory settings: Confirm, Cancel

Selecting “Confirm” will restore the system defaults

- About: Version information

Playback

File Management			
DIRECTORY	VIDEO	VIDEO_ROCK	PHOTO
FRONT	 20240110_182157_f.ts		
REAR	 20240110_181557_f.ts		
	 20240110_181449_f.ts		

III. APP code



Please download the APP with your mobile phone for the first time to use the dashcam.

1. Start the car to make the dashcam into working state, in the mobile phone to settings to find the WIFI name “FHCam - *****”, enter the password 12345678 to connect.

2. After the connection is completed, enter the APP, the time of dashcam will be synchronised with the time of your mobile phone, and the video files and photos on the TF card will also be synchronised to the APP, you can playback and delete the files. Whether you need to format the TF card on APP, you need to check if the files have been saved into TF card.

3. Be sure to format the TF card on dashcam for the first time you use it, and format it once or twice a month regularly.

Note: When formatting TF card, please copy the important files to avoid losing files.

APP function introduction

1. APP interface

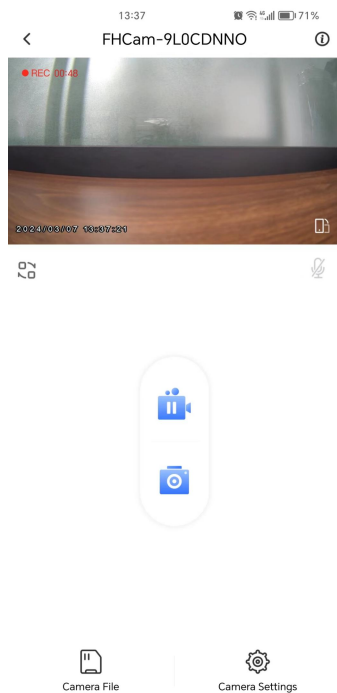

2. Setting interface

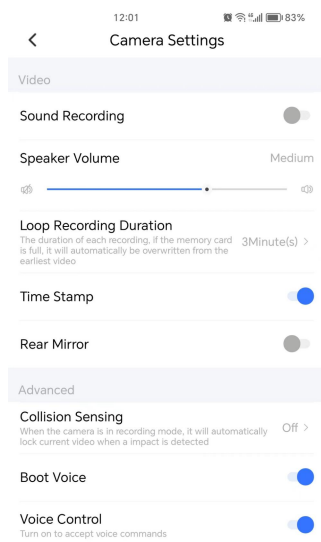

- Sound recording: On, Off
- Speaker Volume: Off, Low, Medium, High, Maximum
- Loop recording Duration: 1 mins, 2 mins, 3 mins
- Time stamp: On, Off (On: video & Photo with time watermark; Off: Video & Photo without watermark)
- Rear Mirror: On, Off
- Collision sensing: Off, Low, Medium, High
- Boot voice: On, Off
- Voice control: On, Off
- Parking monitor collision detection: Off, Low, Medium, High
- Time-Lapse video FPS: Off, 1 Seconds, 2 Seconds, 3 Seconds (the length of video file is set to 1 minute, and the time-lapse recording frames is set to 1 second, which is equivalent to recording a 1-minute video, and the actual recording time is 30 minutes)
- WIFI name: Wifi name can be modified (the dashcam will reset back to the default WIFI name after restoring the factory settings)
- WIFI password: Can manually set to WIFI password (the dashcam will reset back to the default password 12345678 after restoring the factory settings)
- Firmware version: Dashcam software version
- Format: Format card (recommended to format once or twice per month)
- Restore factory settings: Rest settings function

3. APP Playback interface

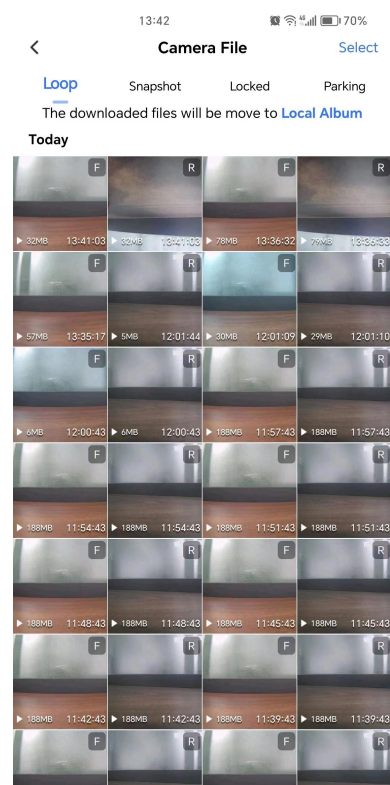

IV. Installation guide

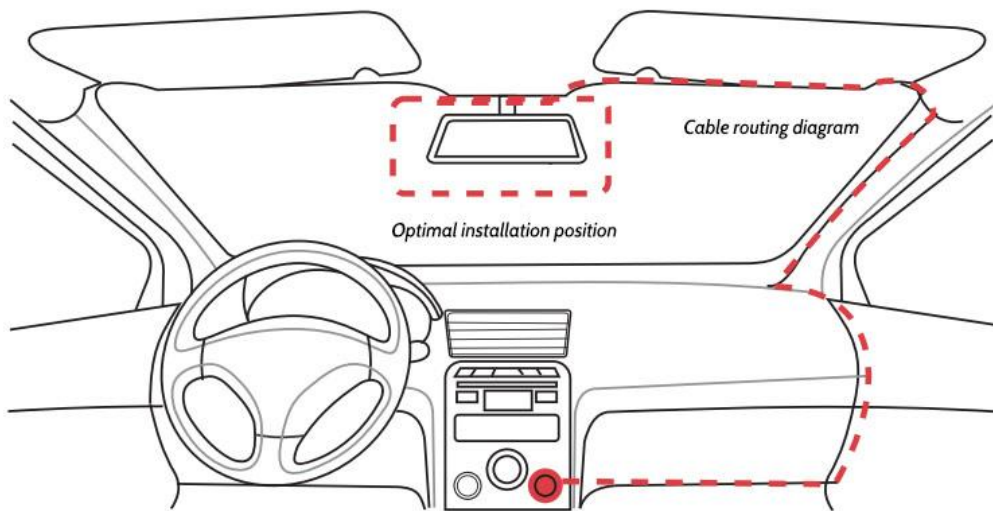

1. Stop the car engine
2. Insert TF card into the card slot
Note: Please use high speed TF card (Class 10 or above)
3. Install the dashcam on the front windshield
Note: When wiring, you can lay the charging cable along the edge of the windshield of the car
4. Install the rear lens at the back of the vehicle, pay attention to the direction when installing, the wiring can be laid along the roof of the vehicle.
After the installation is completed, connect the rear plug to the rear lens port of the dashcam.
5. Adjust the position of the lens to ensure that the lens is level with the ground.
6. Start the engine and check whether the dashcam has been turned on and installed correctly.

Note: When the dashcam is installed correctly, the indicator light will turn on; dashcam start recording, the indicator light is flashing. Please check screen display is working, if it is inverted image, please contact us in time.

FCC Warning

This device complies with part 15 of the FCC Rules. Operation is subject to the following two conditions: (1) This device may not cause harmful interference, and (2) this device must accept any interference received, including interference that may cause undesired operation.

Any Changes or modifications not expressly approved by the party responsible for compliance could void the user's authority to operate the equipment.

Note: This equipment has been tested and found to comply with the limits for a Class B digital device, pursuant to part 15 of the FCC Rules. These limits are designed to provide reasonable protection against harmful interference in a residential installation. This equipment generates uses and can radiate radio frequency energy and, if not installed and used in accordance with the instructions, may cause harmful interference to radio communications. However, there is no guarantee that interference will not occur in a particular installation. If this equipment does cause harmful interference to radio or television reception, which can be determined by turning the equipment off and on, the user is encouraged to try to correct the interference by one or more of the following measures:

- Reorient or relocate the receiving antenna.
- Increase the separation between the equipment and receiver.
- Connect the equipment into an outlet on a circuit different from that to which the receiver is connected.
- Consult the dealer or an experienced radio/TV technician for help.

This equipment complies with FCC radiation exposure limits set forth for an uncontrolled environment. This equipment should be installed and operated with minimum distance 20cm between the radiator & your body.