

## Specification

### Patent Pending

- Part No. : **FXP75.07.0045B**
- Product Name : FXP.75 Atom 2.4GHz Series  
Ultra-Miniaturized 2dBi Bluetooth Antenna
- Features : Patent Pending  
Worldwide smallest cabled 2.4GHz antenna  
Ideal for Bluetooth earphones  
Flexible Ultra Low Profile 5.9\*4.1\*0.24mm  
Adheres directly to inside of product housing  
Form factor and cable routing convenient for integration  
IPEX MHF1 Connector (U.FL compatible)  
45mm  $\varnothing$  0.81mm mini-coaxial cable

**RoHS Compliant**

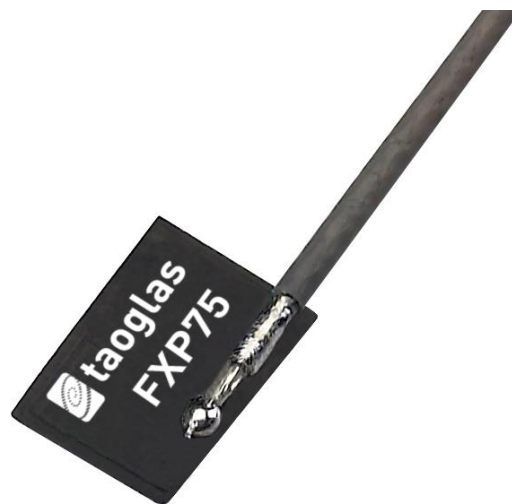

## 1. Introduction

The FXP75 Atom is a super small monopole ultra-low profile antenna for 2.4GHz band that includes Bluetooth, Wi-Fi, ZigBee and ISM bands application. The FXP75 has a peak gain of 2.5dBi at 2.4GHz and efficiencies of 45%.

This Taoglas patent pending antenna is unique in the market. Two years of constant research and development have created the world's smallest coax cabled true 2.4GHz antenna. Made from poly-flexible material, the antenna has a tiny form factor of 5.9\*4.1\*0.24mm and has double-sided 3M tape for easy "peel and stick" mounting.

The cable routes conveniently directly out of the bottom of the antenna, reducing the volume the antenna takes up in the device to an absolute minimum compared to other designs. The FXP75 is the ideal all-round antenna solution for fitting into narrow spaces and still maintaining high performance, for example in a Bluetooth earphone where metal and electrical noise degrades onboard SMT antenna performance. The FXP75 is small enough to be routed away from metal and electrical noise to deliver much improved range and reliable sound quality in Bluetooth earphones.

Many module manufacturers specify peak gain limits for any antennas that are to be connected to that module. Those peak gain limits are based on free-space conditions. In practice, the peak gain of an antenna tested in free-space can degrade by at least 1 or 2dBi when put inside a device. So ideally you should go for a slightly higher peak gain antenna than mentioned on the module specification to compensate for this effect, giving you better performance.

Upon testing of any of our antennas with your device and a selection of appropriate layout, integration technique, or cable, Taoglas can make sure any of our antennas' peak gain will be below the peak gain limits. Taoglas can then issue a specification and/or report for the selected antenna in your device that will clearly show it complying with the peak gain limits, so you can be assured you are meeting regulatory requirements for that module.

For example, a module manufacturer may state that the antenna must have less than 2dBi peak gain, but you don't need to select an embedded antenna that has a peak gain of less than 2dBi in free-space. This will give you a less optimized solution. It is better to go for a slightly higher free-space peak gain of 3dBi or more if available. Once that antenna gets integrated into your device, performance will degrade below this 2dBi peak gain due to the effects of GND plane, surrounding components, and device housing. If you want to be absolutely sure, contact Taoglas and we will test. Choosing a Taoglas antenna with a higher peak gain than what is specified by the module manufacturer and enlisting our help will ensure you are getting the best performance possible without exceeding the peak gain limits.



Due to the potential for detuning in a tiny device environment, Taoglas recommends that you contact us at our regional sales office for integration support and testing and optimization of the antenna in your device before going to production.

## 2. Specification

ELECTRICAL	
Antenna	FXP75
Standard	2400-2500MHz
Operation Frequency (MHz)	2400-2500 MHz
Polarization	Linear
Impedance	50 Ohms
Max VSWR	2:1
Max Return Loss (dB)	<-10
Peak Gain (dBi)	2.5
Efficiency (%)	45
Average Gain (dB)	-3.4
Radiation Properties	Omni
Max Input Power	2W max

\* The FXP.75 antenna performance was measured on a 30x30 mm 2mm thick ABS plastic ground plane.

MECHANICAL	
Dimensions (mm)	5.9*4.1*0.24mm
Required Space (mm)	5.9*4.1*0.24mm
Material	Polymer
Cable	Ø0.81mm coaxial cable
Connector	IPEX MHF1

ENVIRONMENTAL	
Operation Temperature	-40°C to 85°C
Storage Temperature	-40°C to 85°C
Relative Humidity	40% to 95%
RoHs Compliant	Yes

### 3. Antenna Characteristics

#### 3.1 Test set-up



**Figure 1.** Impedance measurements (left side) and peak gain, efficiency and radiation pattern measurements (right side).

#### 3.2 Return Loss

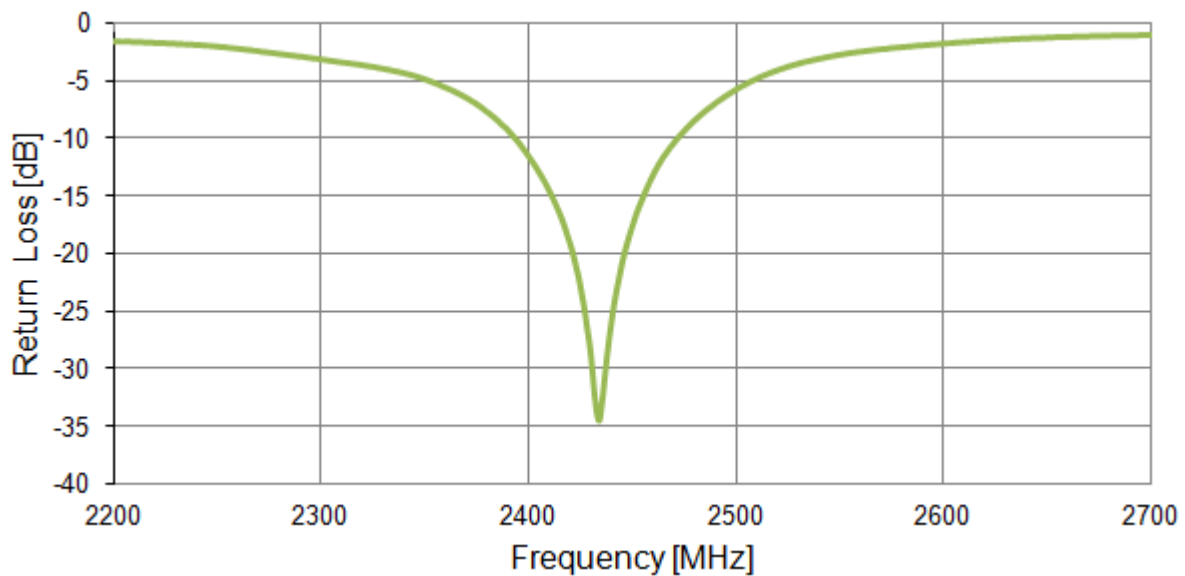

**Figure 2.** Return loss of the FXP75 antenna from 2200 MHz to 2700 MHz.

### 3.3 VSWR

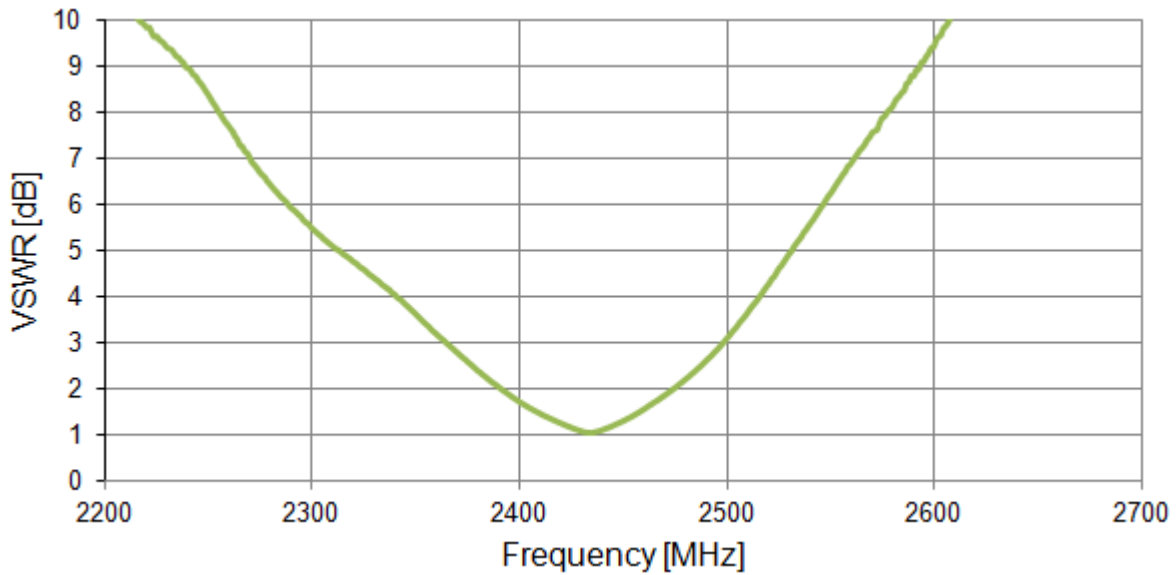

**Figure 3.** VSWR of the FXP75 antenna from 2200 MHz to 2700 MHz.

### 3.4 Efficiency

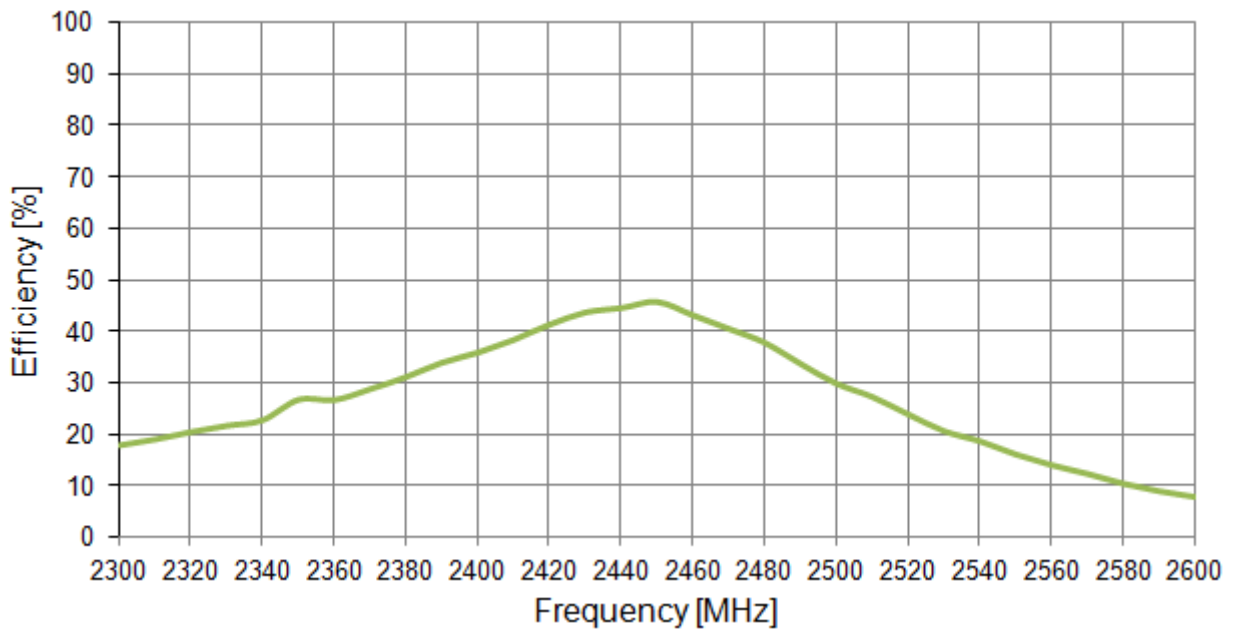

**Figure 4.** Efficiency of the FXP75 antenna from 2300 MHz to 2700 MHz.

### 3.5 Peak Gain

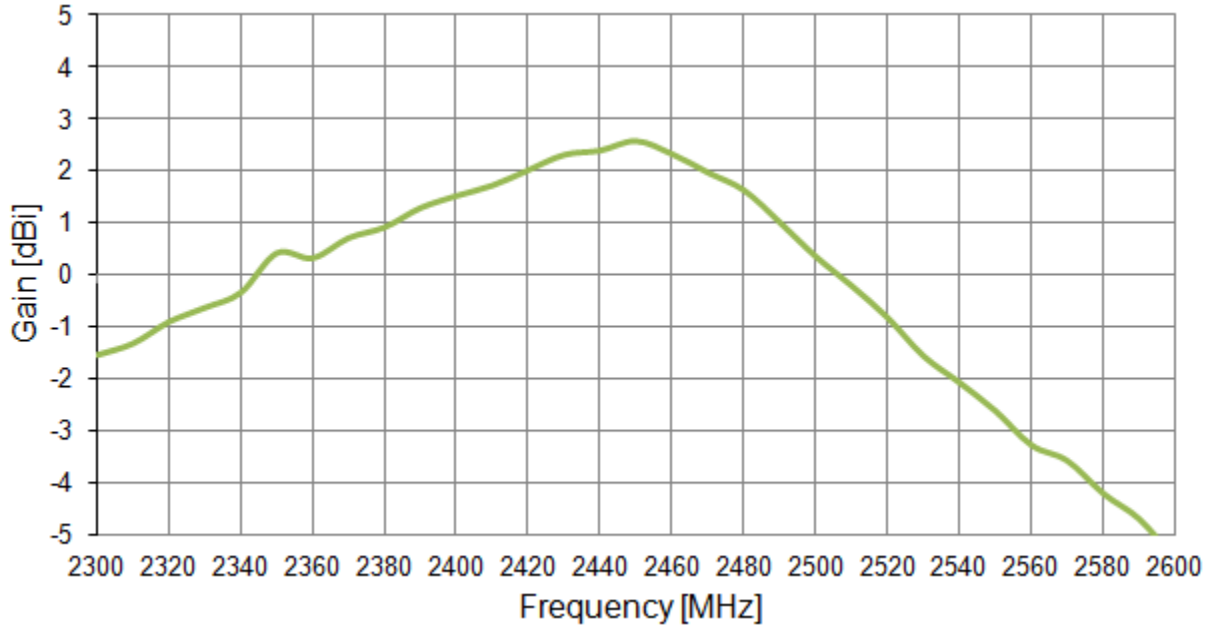

**Figure 5.** Peak Gain of the FXP75 antenna from 2300 MHz to 2700 MHz.

### 3.6 Average Gain

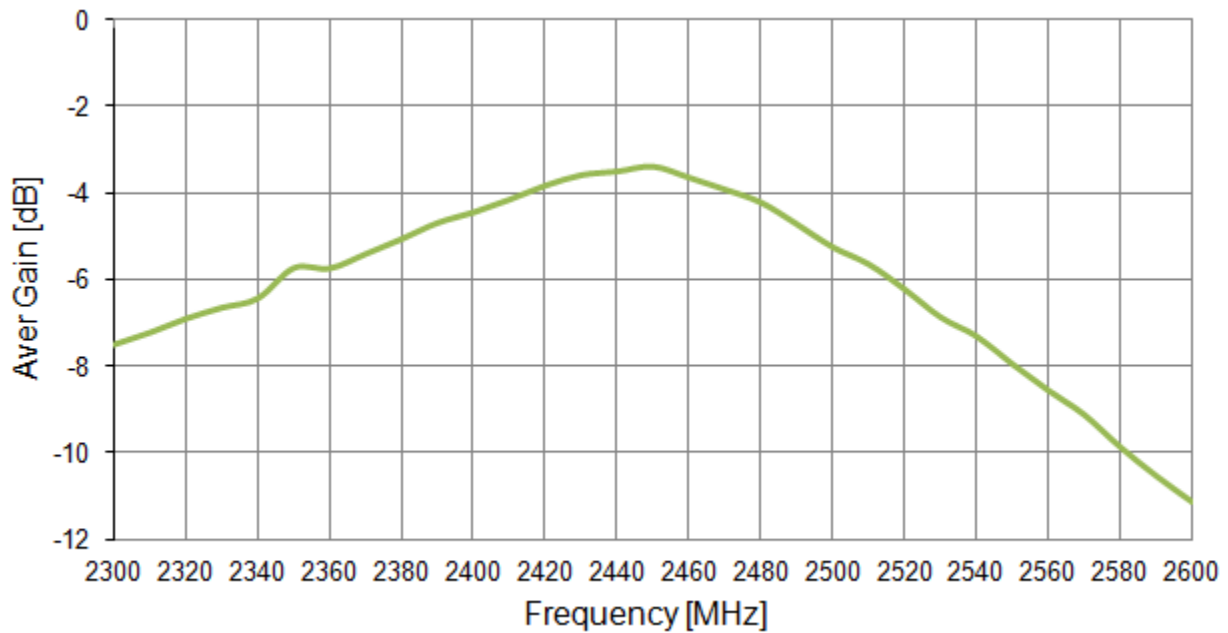

**Figure 6.** Average Gain of the FXP75 antenna from 2300 MHz to 2700 MHz.

### 3.7 3D radiation patterns

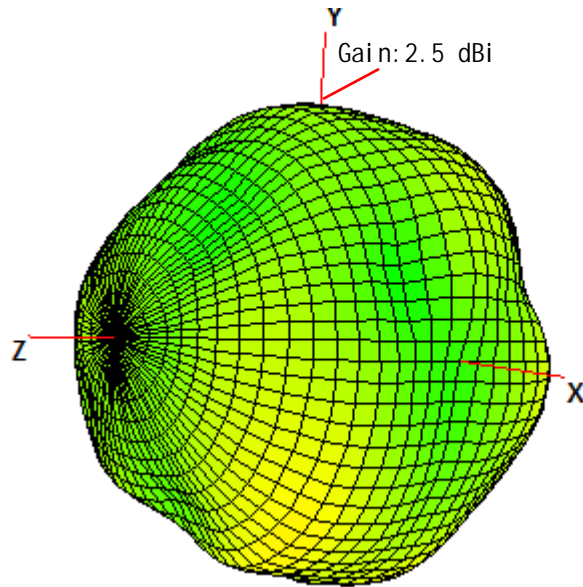
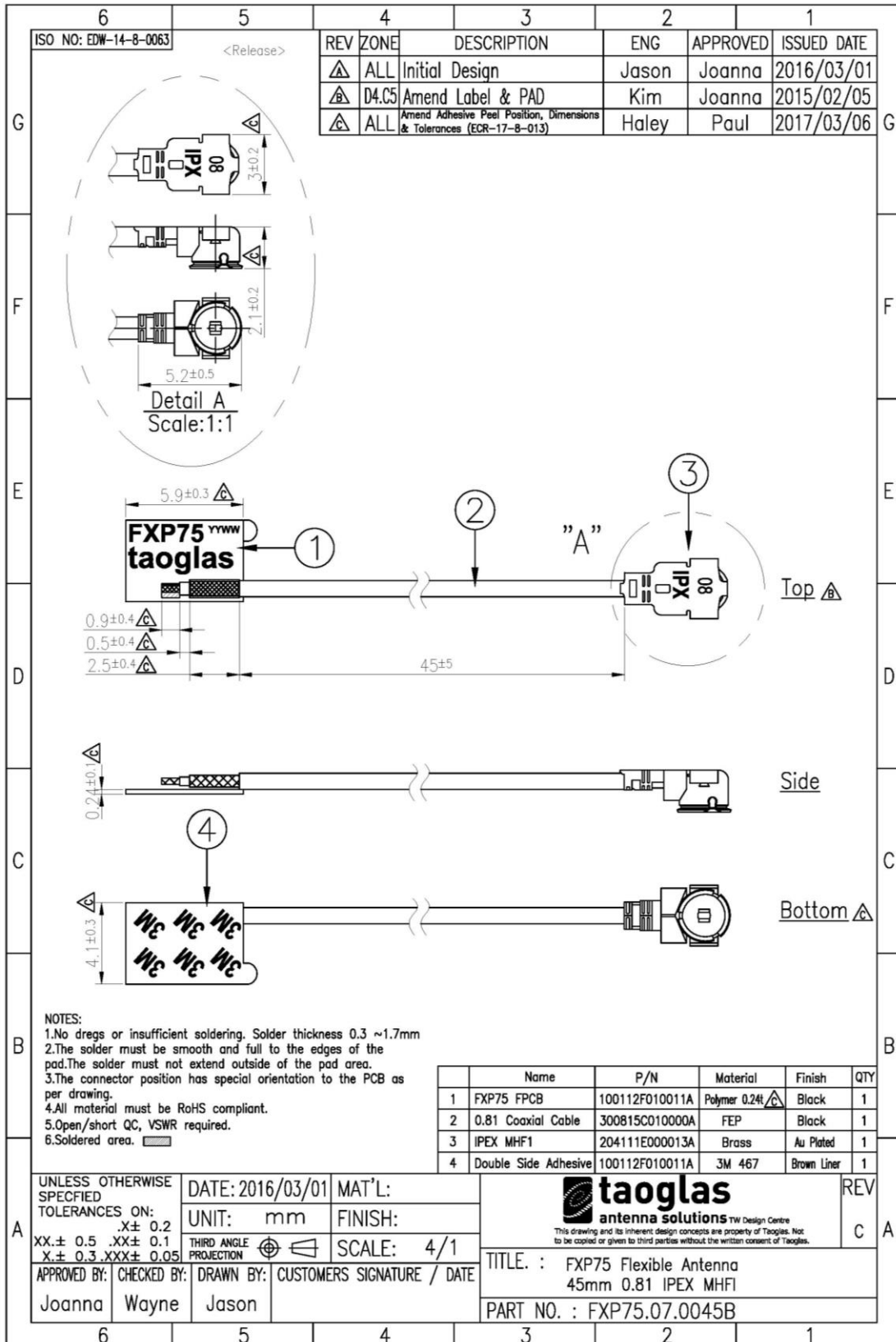

**Figure 7.** 3D Radiation Pattern at 2450 of the FXP75 Antenna.





## 4. Antenna Drawing



## 5. Packaging

100pcs FXP75.07.0045B per PE Bag  
 Dimensions - 59\*41\*0.24mm  
 Weight - 105g

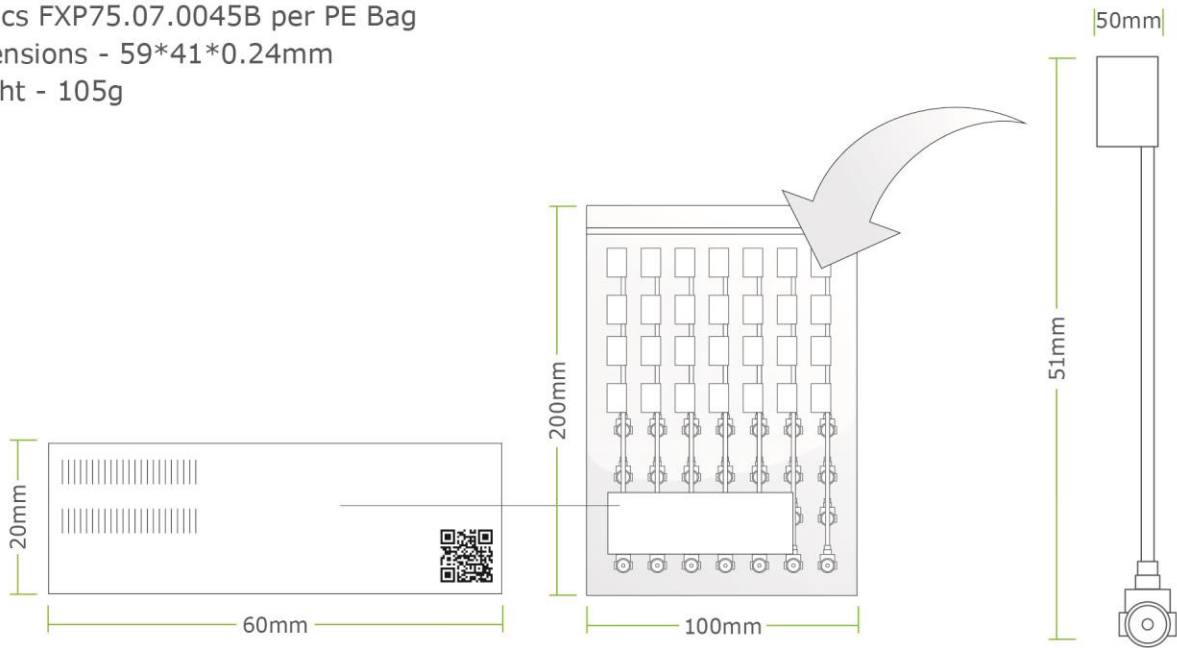

2000pcs per Large Carton  
 Carton Dimensions - 230\*175\*160mm  
 Weight - 2.1Kg

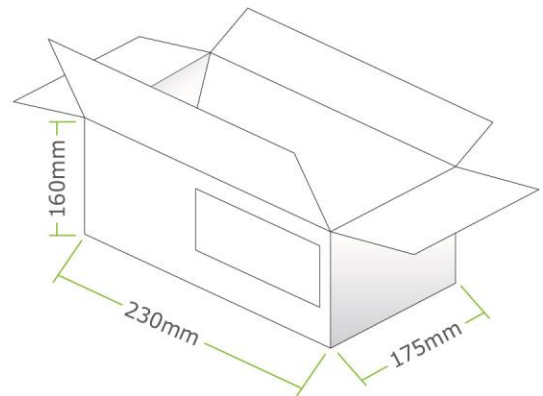



Taoglas makes no warranties based on the accuracy or completeness of the contents of this document and reserves the right to make changes to specifications and product descriptions at any time without notice. Taoglas reserves all rights to this document and the information contained herein.

Reproduction, use or disclosure to third parties without express permission is strictly prohibited.

Copyright © Taoglas Ltd.