



Play / Play Pro

User Manual

English

Table of Contents

1. Introduction	3
2. Precautions (Important for your safety).....	4
3. Description	5
4. In the box	7
5. Warnings and indicators.....	9
6. Operation	11
7. Firmware updates	20
8. Battery	21
9. IP protection.....	21
10. 3 Years Keep Rolling Warranty	22
11. Trademarks	24
12. Specifications	25
13. FCC Compliance Statement	26
14. IC Compliance Statement.....	27
15. Materials statement	28

1. Introduction

The Kelvin Play, an RGBACL LED Panel by Rift Labs, offers a full color spectrum for film industry professionals. Its advanced lighting technology ensures high accuracy and quality across the entire spectrum, enhancing predictability and consistency for creative projects. Focused on superior user experience, both in digital and physical interactions, it exceeds market standards. Durable and robust, it's built to endure the demands of on-set use and more.

1.1. Features

The Kelvin Play offers eco-friendly lighting for professionals, featuring LED lamps for efficient power use and high light output. Its casing is mostly composed of recyclable materials, enhancing its sustainability. The product's lasting quality further reduces its environmental impact. Efficient and sustainable practices in manufacturing, logistics, and packaging make this high-performance product, made in Norway, a greener choice.

1.2. Properties

The Cantastoria Light Engine in the Kelvin Play ensures consistent, precise lighting across the full spectrum, with 0.01% accuracy in light intensity. Its superior build quality meets and exceeds industry standards, offering durability, sturdiness, and compactness. The design's strength lies in its materials and construction, and its form is not only aesthetically pleasing but also functional, allowing versatile storage without compromising the delicate internal electronics. The Kelvin Play surpasses expectations in its category, aiming to raise the bar in industrial design and attention to detail in film lighting. Its design embodies Kelvin's core values: precision, robustness, usability, and accessibility.

1.3. Idea

For creators, cinematographers, photographers, studios, and filmmakers, lighting is crucial in setting a scene's ambiance, transforming a good story into exceptional visual storytelling. Recognizing this, the Kelvin Play is not just about high-quality light but also emphasizes smooth usability for on-set efficiency. It features an intuitive app, Kelvin Narrator, compatible with iOS and Android, allowing users to control the light via Bluetooth, alongside its touchscreen and buttons. This enables seamless integration of a full lighting kit, controllable via smartphone or the light units themselves. Additionally, the Kelvin Play's design and engineering specifically address reliability and power efficiency, key considerations for professionals in the field.

1.4. Form

Electronics and lamps, delicate in nature, benefit from strong casing to protect against damage from drops, tough usage, and exposure to adverse weather conditions. The Kelvin Play's design communicates the essence of a high-tech, precision instrument, while being robust, reliable, and practical. Its inherent simplicity also represents the efficiency of modular production and smart logistics, alongside its recyclability. The prevalent use of aluminum in its construction offers a sturdy yet recyclable build, ensuring long-lasting protection for its sensitive electronics inside.

1.5. Function

The light may be controlled remotely from the Bluetooth, Kelvin Narrator App for iOS/Android, Lumen Radio/Wireless DMX (Play Pro). The light unit can thus be fixed remotely and in out of reach positions. The front of the lamp has magnetic mounts for various accessories that modify the light.

2. Precautions (Important for your safety)

The light fixture is used for professional lighting. The lighting system and accessories must be used by professional or trained personnel. All operations must follow the relevant safety instructions:

1. All instructions must be read and understood before use, including the transport, installation, and operation of the equipment.
2. In case the cable is damaged, it must be replaced with the same kind.
3. In case the light source is damaged, it can only be serviced by an authorized Kelvin service center or authorized Kelvin service personnel.
4. The lamp may reach elevated temperatures when operating. To prevent burns, staff must operate carefully when touching the lamp body.
5. Be alert to fire and burn hazards and do not place flammable materials and objects in front of the lamp.
6. Before each usage, make a visual inspection. Ensure regular inspection at least every 6 months. Record the results in an archive.
7. Operating in an explosive environment is prohibited.
8. Do not operate damaged equipment until an authorized professional service personnel have checked it.
9. The lamp head and accessories must be safely connected or secured to prevent falling.
10. Before cleaning, or doing maintenance or repair, the product must be shut down and the charging cable must be removed from the power outlet.
11. Do not immerse the lamp head in water or other liquids as this may cause damage to equipment and the risk of electric shock.
12. When repair or service is required, do not remove or open the lamp on your own, as this will void the warranty. The product must be handed over to designated qualified maintenance personnel. Incorrect removal may damage the equipment or even cause electric shock when re-using.
13. Do not place cables, plugs, and contact parts in water as this may cause a risk of electric shock.
14. Radiation and glare from the head of the lamp can cause damage to people and animals). Within the minimum distance (2.5m) specified in the equipment and operating instructions, exposure to the beam for a prolonged period has a risk of injury.
15. Do not use non-recommended cables, and other accessories, as this may damage the equipment, or even cause fire or electric shock.
16. When maintenance or service is required, you must contact designated authorized maintenance personnel. Any malfunction caused by unauthorized self-removal is not within the scope of the repair and will void the warranty.
17. This product is certified FCC, CE, RoHS, UKCA, IC, KC, NCC, PSE, BIS, UL. Please strictly refer to the relevant national standards for operation and use. Incorrect use causes damage to the equipment and is not covered by the product warranty.
18. Limitation of Liability. Under no circumstances shall the company, its subsidiaries, brands or its affiliates, partners, suppliers or licensors be liable for any indirect, incidental, consequential, special or exemplary damages arising out of or in connection with your access or use of the product, any errors in the material, or omission of information, and any third-party content and services, whether or not the damages were foreseeable and whether or not company was advised of the possibility of such damages. Without limiting the generality of the foregoing, the company's aggregate liability to you (whether under contract, tort statute or otherwise) shall not exceed the amount of one dollar. The foregoing limitations shall apply even if the above stated remedy fails in its essential purpose.

3. Description

Note that there may be variations due to continuous product development and releases of new versions, please refer to the product itself.

3.1. Lamp layout

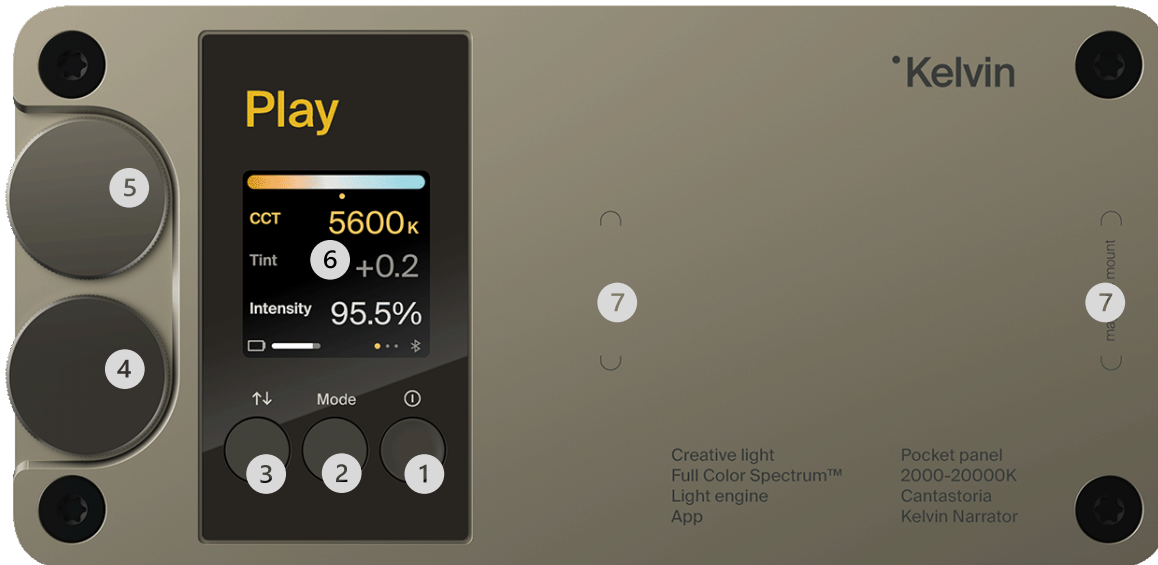

Rear view

- ① Power Button
- ② Mode Button
- ③ Function Button
- ④ Brightness Dial
- ⑤ Adjustment Dial
- ⑥ Display
- ⑦ Magnetic Mount



Front side

- ① LEDs
- ② Accessory magnet attachments

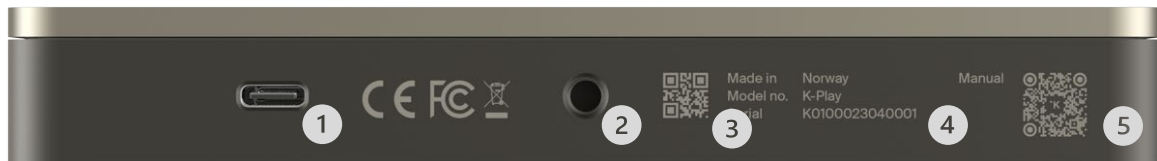

Bottom side

- ① USB-C input connector
- ② 2 pcs ¼-20 mounting holes with pin-lock
- ③ Serial number QR code
- ④ Serial number numeric
- ⑤ User manual QR code

3.2. Accessories



Magnetic attachable accessories

- ① Honeycomb Grid 40
- ② Honeycomb Grid 60
- ③ Diffuser D100
- ④ Diffuser D90
- ⑤ Diffuser D75
- ⑥ Spacer



Multi-Function Ball Head Mount

4. In the box



- 1 x Kelvin Play or Play Pro Full Color Spectrum RGBACL LED Panel Light
- 1 x USB Type-C Power Cable
- 3 Years Keep Rolling Warranty™
- Lifetime customer support



5. Warnings and indicators

Battery low warning

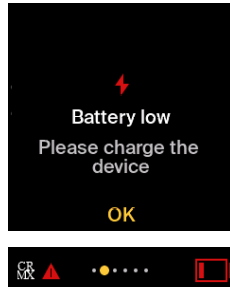

Temperature warning

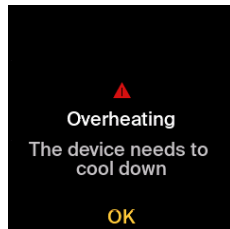

USB low voltage warning

The charger must be a USB PD type (Power Delivery version 2.0 or better), that means a minimum output of 18 Watt and be able to provide 12V.

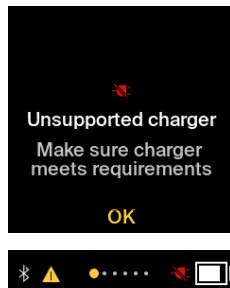

Wireless indicators

Icons at bottom line show wireless status and availability

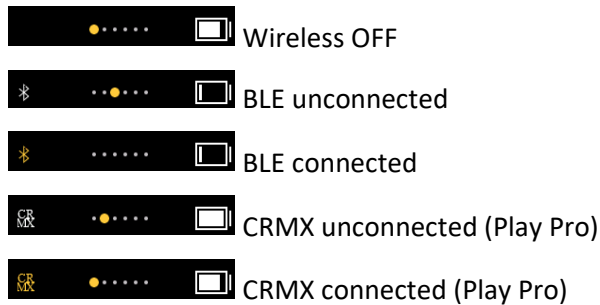

Battery indicators



Dials and buttons locked indicators

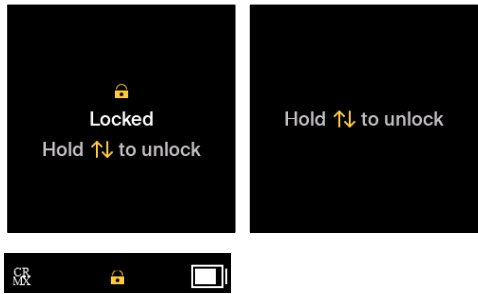

General warning indicator

The warning triangle will appear when there are matters that need attention.



Red coloured warning informs of stats that make the light output turn OFF, while yellow warnings inform of stats that the user should be aware of.

In About, the full list of warnings is shown under Device status.

6. Operation

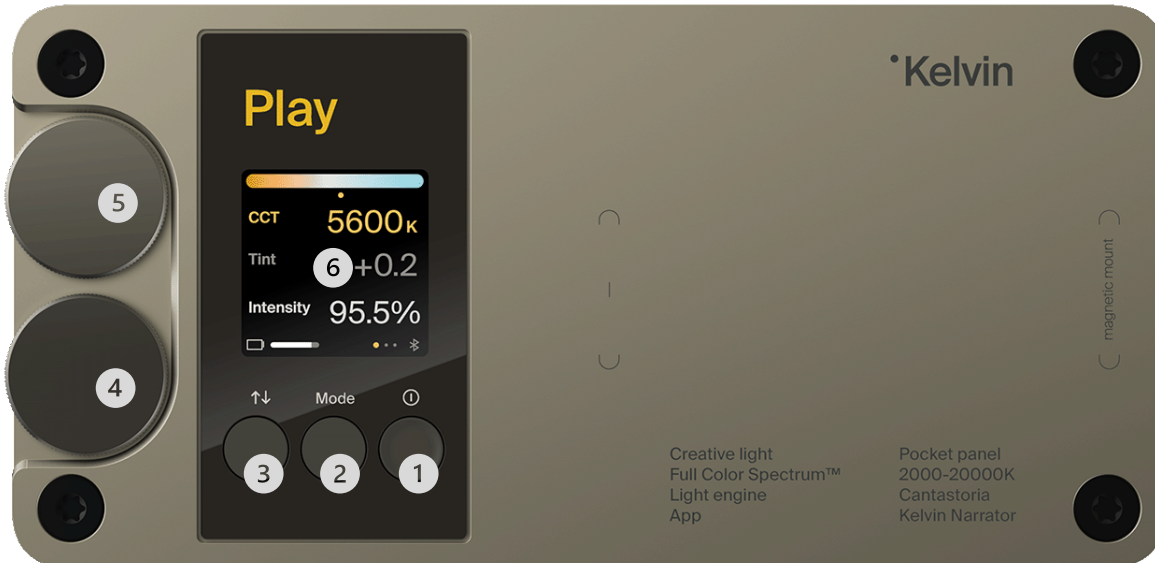

The Play user-interface consists of three buttons, two dials and a display.

- ① Power Button
- ② Mode Button
- ③ Function Button
- ④ Brightness Dial
- ⑤ Adjustment Dial
- ⑥ Display

Press the *Power Button* ① to turn the Kelvin Play ON or OFF.

If the *Power Button* ① is pressed during charging, the PLAY will stay ON, dim the light to 0% intensity and continue charging. Once the charger is unplugged, the PLAY will turn OFF.

Conversely, if a charger is plugged in when the Play is OFF, it will enter standby while charging.

Press the *Mode Button* ② to cycle through the operating modes.

If the *Mode Button* ② is pressed and held (long press), it goes directly to the Menu Screen. A short press on *Mode Button* ② returns to the previous screen. If the previous screen was on the menu, it skips ahead to the next screen of the selected mode carousel. See illustration in section 7.1.

The *Function Button* ③ selects which parameter the *Adjustment Dial* ⑤ adjusts.

In screens featuring menus or lists, a label displayed directly over the *Function Button* ③ indicates an available selectable action.

Long pressing the *Function Button* ③ locks or unlocks all dials and buttons except the *Power Button* ①. The screen will indicate when it is in a locked state.

Rotate the *Intensity Dial* ④ to increase or decrease intensity. A faster rotation will accelerate. Slow down to adjust the brightness in precise intervals of 0.1%.

In most screens a second or third parameter can be adjusted by rotating the *Adjustment Dial* ⑤. Press the *Function Button* ③ to highlight what the *Adjustment Dial* ⑤ controls:

- In CCT, HSI, RGB and GEL, turning the *Adjustment Dial* ⑤ adjusts the parameter selected by the *Function Button* ③.
- In *Effects Mode* the *Adjustment Dial* ⑤ is locked to the effect-type parameter.
- In list screens turning the *Adjustment Dial* ⑤ will scroll through the list or scroll through the available parameter states/values of selected parameter.

About the dials

The *Intensity Dial* ④ always adjusts the intensity (brightness).

The *Adjustment Dial* ⑤ adjusts the parameter selected with the *Function Button* ③.

Screen Orientation

The screen rotates 180° when you turn the Kelvin Play upside down. This is handy if you need to use the mounting hole on the bottom to mount the light from above. Or if you prefer to hold the light in your left hand. In flipped orientation state, the dials will change roles.

! To turn OFF automatic screen rotation, enter *Settings>Display*.

6.1. Mode screens

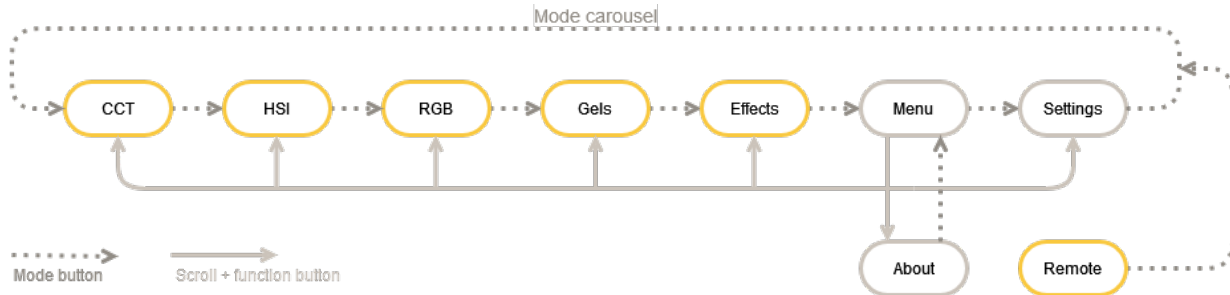

These are the *Mode Screens*:

CCT	White mode
HSI	Adjust color using Hue and Saturation
RGB	Adjust color using R, G and B values
Gels	Digital gels
Effects	Built-in animated light effects
Menu	Lists all available screens, even if deactivated in the mode carousel
Settings	Set up personal preferences
About	Shows serial number, firmware version and device status

CCT mode (White Mode)

In CCT Mode, also called White Mode, the light can be adjusted within the Kelvin scale.

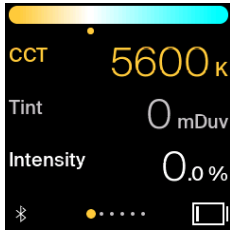

The dials adjust brightness, color temperature and tint. Brightness is adjustable from 0.0 to 100.0%.

Scroll fast to jump between the industry-standard presets, Tungsten, Fluorescent, Daylight etc. up to Clear Blue Sky. Slow down to adjust the precise color temperature in increments of 20 Kelvin.

Press the *Function Button* ③ to toggle between color temperature and green/magenta tint.

HSI Mode (Color Mode)

For creating a color wash or a dramatic effect, switch to HSI Mode, also referred to as Color Mode.

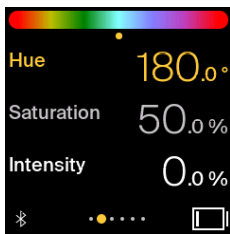

The *Adjustment Dial* ⑤ cycles through colors from the color wheel. Due to display space constraints, this wheel is represented as a horizontal color bar at the top. The display indicates the corresponding hue angle from the color wheel in degrees.

The saturation is shown in percentage, and 100.0% means fully saturated color. When lowering the saturation, the color will be gradually less saturated. At zero saturation, the light becomes white, reflecting your chosen color temperature, or your desired white point.

! The white point of HSI can be changed in *Settings>Light*.

RGB mode

Set a color using trichromatic (RGB) adjustment.

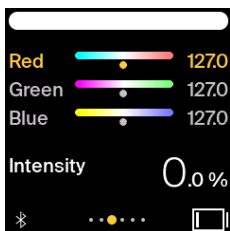

Use the *Function Button* ③ to select which parameter to adjust, and the *Adjustment Dial* ⑤ to change the value. The color bar at the top shows the resulting color.

! The *White Point* of RGB can be changed in *Settings>Light*.

Gel mode (filter mode)

Pick any of the pre-selected filters from the list.

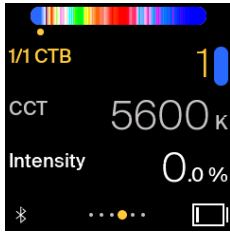

The Kelvin Play offers a diverse array of digital gel filters. With *Filter Mode*, matching the color temperature of nearby lights is straightforward. Once aligned, any of the available digital gels can be selected to add a hint of color for background illumination or as an accent light. Each gel is numbered and titled and features a color bar of the color hue and the exact color temperature.

The Play contains more than the pre-selected gel filters. All pre-defined gels are accessible from the *Kelvin Narrator App*.

! The filter will be applied on top of any color temperature selected.

Effects Mode

The Kelvin Play has several built in animated light effects.



The purpose of the *Effects Mode* is to be able to start and stop effects directly from the Play. Each effect has multiple settings and parameters. The parameters of the various effects are adjusted in the Kelvin Narrator App, and the Play will keep these settings until changed again in the app.

Play Pro allows setting the effect parameters via CRMX and BLE DMX services.

The *Adjustment Dial* ⑤ scrolls through the available effects, and the *Function Button* ③ starts or stops the effect.

Descriptions of the effects:

Fire	Simulates the light of a candle, campfire, or bonfire in various wind conditions.
CCT Chase	A transition between two preset color temperatures. This can be used for simulating a sunrise, sunset, or a change from cloudy to sunny weather in real time. The sequence can be looped in various types.
Color Chase	A transition that moves through the color wheel between two selected colors. The sequence can be looped in various types.
Pulse	Creates a steady pulse at a programmable rate. Pulses per minute and pulse form can be adjusted to set the pulse behavior, while the color of the strobe is defined by selecting color type and parameters.

Strobe	The light output is strobed. Strokes per minute and flash duration can be adjusted to set the strobe behavior, while the color of the strobe is defined by selecting color type and parameters.
Dimming	Program a light output color and change the intensity over time. Dimming curve, transition time, start delay and loop type can be adjusted while the color of the strobe is defined by selecting color type and parameters.
Lightning	An effect that simulates lightning. Storm intensity, color randomness and type can be adjusted.

Menu

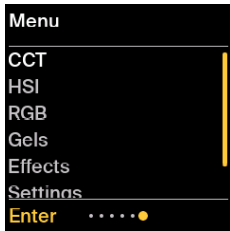

The *Menu Screen* shows all available modes in the Mode Carousel. Use *Adjustment Dial* ⑤ to scroll and *Function Button* ③ to select which to open.

Settings

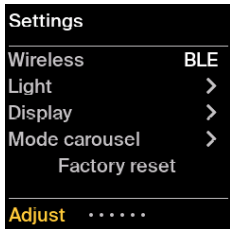

! Pay attention to the button labels. Most parameters have to be entered and verified while others can be toggled.

The *Settings Screen* contains following options:

Wireless	Choose what wireless technology to use, or to turn OFF wireless senders. <ul style="list-style-type: none"> • OFF • BLE (Bluetooth) • CRMX (only available for Play Pro)
Light	Opens the <i>Light Settings</i>
Display	Opens the <i>Display Settings</i>
Mode carousel	Opens the <i>Mode Carousel Editor</i>
Factory reset.	Opens the <i>Factory Reset Screen</i>

DMX & CRMX

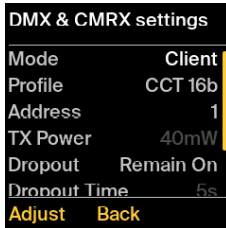

These settings are only available for the Pro version of the Play. On this screen the DMX profiles and the CRMX parameters can be set:

Mode	<p>Select whether this Play device is to listen to wireless DMX transmissions or to control the DMX transmissions.</p> <ul style="list-style-type: none"> • Client, the Play will listen to its linked wireless host and perform the DMX instructions. • Host, the Play will control linked wireless clients by generating the DMX instructions.
Profile	<p>Select the DMX profile that the Play will respond to or control. The full list of profiles is available in the Kelvin DMX protocol document.</p> <p>All DMX profiles are available in 8-bit and 16-bit formats.</p> <p>Note that in host mode, only the profiles supported by the Play user interface are available.</p>
Address	<p>Select the DMX start address for the Play.</p> <ul style="list-style-type: none"> • 1-512
TX Power	<p>Select the transmitting power of the wireless module when Play Pro is in host mode. This setting is not selectable if the Play Pro is in client mode.</p> <ul style="list-style-type: none"> • 3, 13, 40 and 100 mW
Dropout	<p>Select the DMX behavior when the CRMX loses connection. This setting is only selectable when the Play Pro is in client mode.</p> <ul style="list-style-type: none"> • Remain ON, the last DMX instruction remains valid, and the light output remains the same. • Blackout, the light output turns OFF • Delayed, the light output turns OFF after the set time in the Dropout time setting.
Dropout time	<p>Select the blackout delay if the wireless connection is lost. This setting is only available if the Dropout settings are set to “Delayed”.</p> <ul style="list-style-type: none"> • 1-300 seconds

Radio status	<p>Displays the radio status of the Play Pro.</p> <ul style="list-style-type: none"> • Inactive: Radio is OFF. • No Link: CRMX radio is not linked to any host when in client mode. • Linked: CRMX radio is linked to a host, but the host is not available when in client mode. • Active: Radio is linked, and the host is available in client mode, or that the radio is ON and working when in host mode. • Linking: Play Pro is linking to client when in host mode.
Link/unlink	<p>Start the link or unlink process of the CRMX radio.</p> <ul style="list-style-type: none"> • Link: Play Pro is in host mode. If pressed the CRMX radio will start linking to all powered and unlinked clients in the area. • Unlink: Play Pro is in client mode. If pressed the CRMX radio will unlink from the currently linked host.

Light Settings

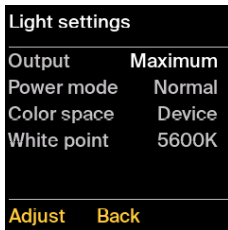

The *Light Settings* Screen contains following options:

Output	<p>Select the light output strength behavior regarding changing light parameters:</p> <ul style="list-style-type: none"> • Maximum outputs maximum light (Lux) no matter the adjusted parameters. (E.g., in CCT mode, 5600K will output more light than 2000K.) • Constant, outputs constant light (Lux) based on the light mode range. (E.g., in CCT mode, 5600K will output the same amount of light as 2000K.)
Power mode	<p>Select the allowed power limit for the light output:</p> <ul style="list-style-type: none"> • Normal, the default limit set for the Play to operate stably over time. • Boost, an increased limit that generates about 35% more light output (Lux). However, this mode can cause the Play to overheat which in turn will require a cooldown period.
Color space	<p>Selects the color space options:</p> <ul style="list-style-type: none"> • Device • sRGB • Adobe RGB • Adobe Wide • Pro Photo • DCI P3 • Rec.2020

White point	Sets the White Point
-------------	----------------------

Display Settings

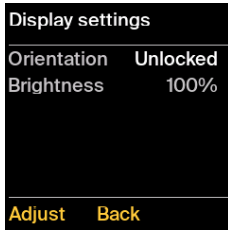

The *Display Settings Screen* contains following options:

Orientation	<p>Selecting display and dial behavior based on the orientation of the Play.</p> <ul style="list-style-type: none"> • Unlocked, the content on the display will rotate 180° and the dials will switch functionality based on the orientation of the Play. • Locked, prevents the orientation from changing when the Play is rotated or flipped.
Brightness	Selecting the non-idle display brightness 0-100%

Mode Carousel



The *Mode Carousel* is customizable, allowing for quick access to selected modes. Modes that are toggled 'ON' will appear in the list when you press the *Mode Button* ② later.

The following screens can be added or removed from the *Mode Carousel*:

- CCT
- HSI
- RGB
- Gel
- Effect
- Menu
- Settings (disabled by default)

Factory Reset

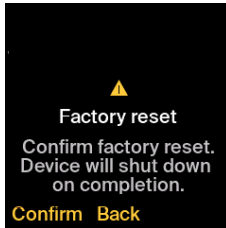

Factory Reset will reset all light parameters and all adjusted settings to the default values and states as when the Play was first turned ON. A confirmation is required to proceed with the factory reset.

About

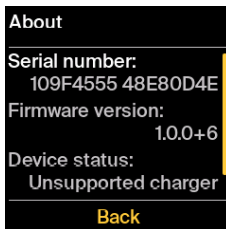

The *About Screen* shows the following information:

- Serial Number
- Firmware version
- Device status – Displaying any active warnings.
- Remote - Shows if the Play is controlled remotely in a mode not supported by the interface

Stats

The *Stats Screen* can be entered via the *About Screen*.

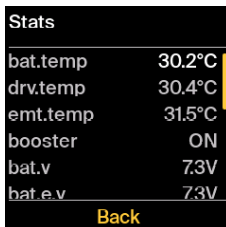

The *Stats Screen* displays internal values that can be used to troubleshoot the Play.

How to mount the Kelvin Play during use

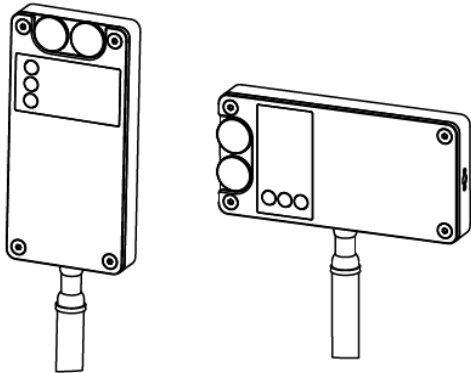

Placed on tripod. There is a 1/4-20 pin lock mounting option on the right and on the bottom side of the light.

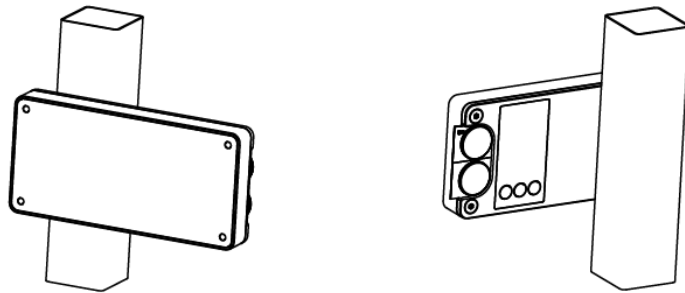

Mounted using the built-in magnets.

It is advised to turn the light off when not mounted.

7. Firmware updates

The Kelvin Play is designed to make it easy to install firmware (FW) updates. Firmware updates are done Over the Air (OTA) using the *Kelvin Narrator App*.

Firmware update steps.

1. Download the *Kelvin Narrator App*, available through the App Store and the Google Play Store: <https://www.kelvinlight.com/app-narrator/>
2. If the app is already installed, make sure it is up to date to have the latest FW version for the Play.
3. Open the app and connect to the Play.
4. Once connected, the app will automatically check the FW version of the connected device and give the option to update the FW if a newer version is available.
5. The app will then start uploading the new FW. This step will take a few minutes.
6. Once the upload is done, the Play will reboot and is ready to use.
7. (Optional) Check out the *About Screen* to see if the FW is updated.

If the update fails, usually caused by bad data transfer from the mobile device running the Kelvin Narrator app to the Play, the Play will reboot once more and revert to the previous FW version. In this case, retry uploading the new FW again.

It is possible to reject the update in the *Kelvin Narrator App* so update notifications do not pop up. In this case, FW update can be done by pressing the firmware button under Settings in the *Kelvin Narrator App*.

8. Battery

When the Kelvin Play runs on its internal battery, a battery icon showing the remaining battery power appears onscreen.

8.1. Recharging the Battery

The internal battery can be recharged via the USB Type-C port. A USB-C charger can power the Kelvin Play light and charge the battery at the same time. Kelvin Play will prioritize power for the light before charging, but any excess power is used for charging the battery. This means that at full brightness the battery will charge slower, and at low brightness or OFF, the battery will charge faster.

The charger must be a USB PD type (Power Delivery version 2.0 or better), that means a minimum output of 18 Watt and be able to provide 12V. If a charger that can only supply 5 volts is connected, Kelvin Play will turn ON, but a warning will show that the power source is insufficient.

9. IP protection

The Kelvin Play has an IP65 rating. This means that it has environmental protection and can be used outdoors. It should not be submerged in water, so do not go diving with it.

10. 3 Years Keep Rolling Warranty

Our philosophy of creating a light for cinema doesn't stop at the product itself. Life on set doesn't always go as planned. And we are prepared. The Keep Rolling Warranty is Kelvin's way of giving back to the cinema community. Latest updated version available at www.kelvinlight.com.

When using one of our products, you will have peace of mind. Your projects are our highest priority, so if anything goes wrong – we make sure you have a light to keep rolling.

If you have purchased your light through one of our resellers you can extend your warranty to three years by registering your product through submitting the warranty form.

10.1. Definitions

For the purposes of this Warranty Policy, the following words and expressions shall have the following meaning unless the context otherwise requires:

- a) "Solution" means the specified version of Our delivery as further agreed, which may include Our patented Kelvin LED software and intelligent lightning control systems, its software and firmware, mobile application, and any appurtenant products and services.
- b) "We", "Us" or "Our" means Rift Labs AS, a limited liability company incorporated under the laws of Norway, bearing the Norwegian organization no. 895 734 942, including entities within the same company group.
- c) "You", "Your" or "Yourself" means the party that have placed an order for Our Solution. When acting on behalf of a business, company or other legal entity or private individual, the reference to "You" and "Your" herein shall include, refer and apply to you personally, that particular business, company or other legal entity and that particular private individual, as well as any other entities, employees and all other individuals which is granted access to the Solution.

10.2. Warranty

- a) We firmly believe that the key to Our success rests solely on customers such as Yourself being satisfied with the Solution. As such, it is Our great pleasure to warrant to You that the Solution will be of good quality and workmanship and free from material defects.
- b) As part of Our commitment to customer satisfaction, we provide a Keep Rolling three-year warranty against defects in materials and workmanship in the Solution, under the laws of the country where You have made the purchase of the Solution.
- c) Notwithstanding Clause 2.2 above, a Solution sold to You as refurbished is warranted for a period of ninety (90) days.
- d) Every Solution is sold with lifetime customer support, which entails that You are entitled to remote customer assistance by mail or phone for the Solution even if the warranty period has expired.
- e) Upon the expiration of the time periods identified herein, Our liabilities will cease. In no event shall We be liable for consequential damages.

10.3. Repairs and replacements

- a) In the event of a claim covered by Our warranty, We will repair or replace (at Our sole discretion) the Solution with a new, rebuilt or refurbished product of equal or similar features and functionality. We may use refurbished parts for repairs or replacements. Certain Solution may be subject to a separate software license agreement.
- b) We may provide You with a replacement Solution while the repair or re-delivery procedures are being undertaken. Any replacement Solution must be returned to Us free from damage and in its original packaging.
- c) Any parts replaced by Us during the warranty repair are the property of Us and will not be returned to You.

- d) Any repaired or replaced Solution shall be warranted for a period the greater of (i) the balance of the existing warranty period or (ii) ninety (90) days after it is received by You. Only the components that were repaired or replaced will be eligible for the 90-day period as set forth above. Any parts replaced during warranty repair is Our property and will not be returned to You.

10.4. Refunds

Any reimbursements will be made to the card used by You when paying for the Solution.

10.5. Exclusions

11.5.1 We do not honor warranty agreements extended by third parties. Only warranty agreements granted by Us will be honored.

11.5.2 Our warranty does not extend to maintenance, repair or replacement necessitated by loss or damage of or to a Solution resulting from any cause other than normal use and operation of the Solution in accordance with the Our specifications and manuals, including but not limited to:

- a) Alterations, modifications or repairs by You or unauthorized third parties
- b) Exposure to weather conditions
- c) Water damage
- d) Operator negligence
- e) Use of improper electrical/power supply
- f) Accidents and droppage
- g) Improper handling or storage
- h) Transportation damage, save for Our initial shipment of the Solution
- i) Damage caused by third party products
- j) Cosmetic damage or other non-operating parts
- k) Defective batteries
- l) Battery leakage
- m) Lack of maintenance
- n) Use of cables or accessories provided by third parties

11.5.3 The warranty does not apply to merchandise, accessories or associated software of the Solution, nor does it apply to software that is etched directly into a piece of hardware within or on top of the Solution (“firmware”).

11.5.4 Except as specifically set forth above, all other warranties, conditions, representation or terms, express or implied, whether by statute, common law, custom, usage or otherwise as to the Solution are, to the fullest extent permitted by any applicable law, excluded from this Warranty Policy including any warranty as to the performance or result of the Solution.

11.5.5 The sole remedy under Our warranty shall be the repair, replacement, or credit for defective parts of the Solution as stated above. This warranty is the sole warranty provided by Us and is in lieu of any other warranties either express or implied.

11.5.6 This warranty extends to You and is non-transferable to other third parties. We will not be liable for any property damage, lost time, or lost data resulting from the failure of any Solution or from delays in service or the inability to render service.

10.6. Exercising the warranty

11.6.1 If You wish to make a warranty return in accordance with the above terms, You must provide Us with a notice clearly indicating Your desire to do so.

11.6.2 Following the notification described in Clause 6.1, You must ship the Solution to Us in accordance with the instructions provided by Us. You are responsible for delivering at Your sole risk and cost the damaged Solution to such address as is noted by Us. Furthermore, You are responsible for any shipping costs incurred in returning the Solution and We highly recommended that You use a traceable and insurable form of mail for shipment.

10.7. Compliance

11.7.1 You agree to comply with all applicable export and re-export restrictions and regulations of the Department of Commerce and any other United States, European Union or foreign agencies and authorities in connection with Your use of the Solution. You agree to not violate any local, state, federal or foreign laws and not to transfer or authorize the transfer of any materials to a prohibited country in violation of any laws. By using any materials in the Solution subject to any such restrictions and regulations, You represent and warrant that You are not located in, under the control of, or a national or resident of any such country or on any such list.

11.7.2 You acknowledge that You have been advised of the dangerous goods shipping requirements relating to lithium-ion batteries. If Your return includes a lithium-ion battery, You agree to have the battery shipped by a certified shipper of dangerous goods. You further agree not to attempt to ship any lithium-ion battery that has been physically damaged.

11. Trademarks

Kelvin ® is a registered trademark of Rift Labs. © 2023 Rift Labs AS. All rights reserved.

Product name, logo, brands, and other trademarks featured or referred to within Kelvin and Rift Labs are the property of their respective trademark holders.

<https://tsdr.uspto.gov/#caseNumber=90705176&caseType=SERIALNO&searchType=statusSearch>

<https://tsdr.uspto.gov/#caseNumber=97672213&caseType=SERIALNO&searchType=statusSearch>

<https://tsdr.uspto.gov/#caseNumber=97672213&caseType=SERIALNO&searchType=statusSearch>

<https://euipo.europa.eu/eSearch/#details/trademarks/018469270>

12. Specifications

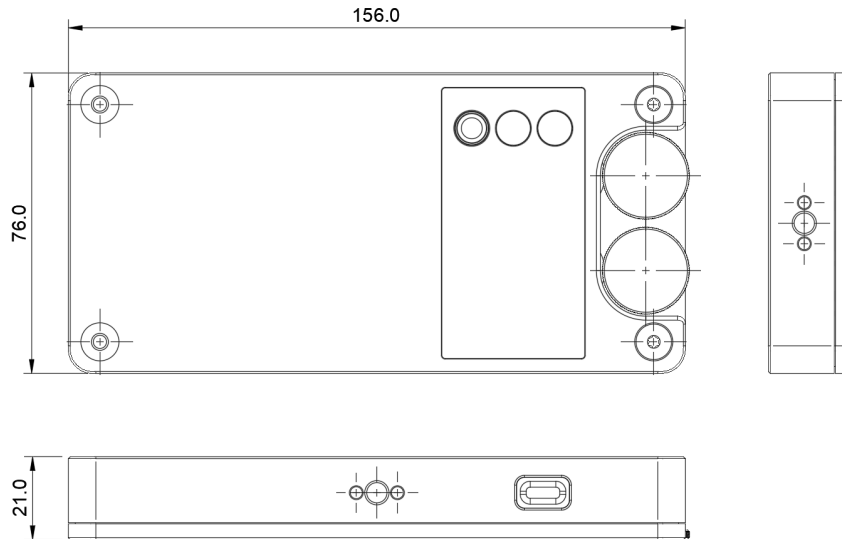

Light Engine	Cantastoria (RGBACL) Six-Color
Color Temperature	2,000 to 20,000 K \pm 100 K
Modes	CCT, HSI, RGB, GELS, EFFECTS, XY
Dimming	0-100% in 0.1% steps
Display	1.3" TFT LCD
LEDs	RGBACL LEDs in 18 clusters of 6 LEDs, 108 LEDs in total
Panel Size	131 x 53 mm
Expected Lamp Life	50 000 hours
Beam angle	106°
Light Intensity	941 lux at 5 600 K / 0.5 m
Color Accuracy Standard	CRI 98 TLCI 99 CQS 97 SSI 86 @3200K SSI 74 @5600K
Connectors	1 x USB C
Wireless Connections	Bluetooth 5.2 with extended range Wireless DMX (CRMX from LumenRadio with RDM)
Remote operation	Kelvin Narrator App Wireless DMX (built-in CRMX from LumenRadio with RDM) Bluetooth
Wireless Range	\leq 100m
Power Source	Built-in battery charged via USB, or USB power input

Battery charging	PD - 9 VDC, 12 VDC, 15 VDC
Max Power Consumption	10W
Cooling System	Passive
Fixture Mount	2 x 1/4"-20 Female Thread Magnetic Mount
Accessory Mount	Kelvin MagTech™ (proprietary)
Housing Material	Aluminum
Fixture Dimensions	156 x 76 x 21 mm / 6.14 x 2.99 x 0.82 in
Fixture Weight	375 g / 0.827 lbs
Operating Temperature	-4 to 113°F / -20 to 45°C
IP Rating	IP65
Certifications	CE UKCA FCC ID: 2BG3G-KPLAYPRO IC ID: 32627-KPLAYPRO KC ID: RRDGeKPLAYPRO ROHS, NCC, PSE, BIS
Play Model Number	K-PLAY
Play Pro Model Number	K-PLAY-PRO

13. FCC Compliance Statement

This device complies with part 15 of the FCC Rules. Operation is subject to the following two conditions:

This device may not cause harmful interference, and (2) this device must accept any interference received, including interference that may cause undesired operation. Any Changes or modifications not expressly approved by the party responsible for compliance could void the user's authority to operate the equipment. Note: This equipment has been tested and found to comply with the limits for a Class B digital device, pursuant to part 15 of the FCC Rules. These limits are designed to provide reasonable protection against harmful interference in a residential installation. This equipment generates uses and can radiate radio frequency energy and, if not installed and used in accordance with the instructions, may cause harmful interference to radio communications. However, there is no guarantee that interference will not occur in a particular installation. If this equipment does cause harmful interference to radio or television reception, which can be determined by turning the equipment off and on, the user is encouraged to try to correct the interference by one or more of the following measures:

- Reorient or relocate the receiving antenna.
- Increase the separation between the equipment and receiver.
- Connect the equipment into an outlet on a circuit different from that to which the receiver is connected.
- Consult the dealer or an experienced radio/TV technician for help.

This equipment complies with FCC radiation exposure limits set forth for an uncontrolled

environment. This equipment should be installed and operated with minimum distance 20cm between the radiator & your body.

14. IC Compliance Statement

This device complies with Industry Canada's licence-exempt RSS standard(s). Operation is subject to the following two conditions:

- (1) this device may not cause interference, and
- (2) this device must accept any interference, including interference that may cause undesired operation of the device.

Le présent appareil est conforme aux CNR d'Industrie Canada applicables aux appareils radio exempts de licence. L'exploitation est autorisée aux deux conditions suivantes:

- (1) l'appareil n' doit pas produire de brouillage, et
- (2) l'utilisateur de l'appareil doit accepter tout brouillage radioélectrique subi, même si le brouillage est susceptible d'en compromettre le fonctionnement.







This Class B digital apparatus complies with Canadian ICES-003.

Cet appareil numérique de la classe B est conforme à la norme NMB-003 du Canada.

IC RF Statement: When using the product, maintain a distance of 20cm from the body to ensure compliance with RF exposure requirements.

Déclaration IC RF: Lors de l'utilisation du produit, maintenez une distance de 20 cm du corps pour garantir conformité aux exigences d'exposition aux RF

15. Materials statement

Enclosure	Aluminum	
USB gasket and buttons	Silicone rubber	
Knob lock	POM	
Honeycomb clamp	PC/ABS	
Honeycomb grid	Aluminum	
O-ring gaskets	Silicone	
Diffusers	PMMA	
Battery foam	Expanded PE	
Diffuser gasket	Expanded PE	
Knob washers	PTFE	
Battery	Lithium-ION	

Electronic and mechanical parts are all RoHS and REACH compliant and do not contain Lead (Pb), Mercury (Hg), Cadmium (Cd), Hexavalent chromium (Cr6+), Polybrominated biphenyls (PBB) or Polybrominated diphenyl ether (PBDE). The device also does not contain PVC or Beryllium.

For more details, visit www.kelvinlight.com.