

FCC PART 15 SUBPART C TEST REPORT
FCC PART 15.247

Report Reference No.....: BSL24060039P01-R02

FCC ID.....: 2BG2D-MS299246AAB

Compiled by (position+printed name+signature)..: Engineer/ Cindy Zheng

Supervised by (position+printed name+signature)..: Manager/Haley Wen

Approved by (position+printed name+signature)..: RF Manager/ Vivian Jiang

Date of issue.....: July 19, 2024

Testing Laboratory Name.....: BSL Testing Co., Ltd.

Address.....: 1/F, Building B, Xinshidai GR Park,Shiyan Street, Bao'an District, Shenzhen,Guangdong, 518052, People's Republic of China

Applicant's name.....: Zhejiang Lijujia Sports Equipment Co., Ltd.

Address.....: No.58, Dangui South Road,Xicheng Street,Yongkang City,Zhejiang, China.

Test specification.....:

Standard.....: FCC Part 15.247

BSL Testing Co., Ltd.All rights reserved.

This publication may be reproduced in whole or in part for non-commercial purposes as long as the BSL Testing Co., Ltd. is acknowledged as copyright owner and source of the material. BSL Testing Co., Ltd. takes no responsibility for and will not assume liability for damages resulting from the reader's interpretation of the reproduced material due to its placement and context.

Equipment description.....: Treadmill

Trade Mark.....: N/A

Manufacturer.....: Zhejiang Lijujia Sports Equipment Co., Ltd.

Model/Type reference.....: MS299246AAB

Listed Models: 8290, 8295, 8300, 8310, 8320, 8321, 8322, 8323, 8325, 8326, 8328, 8329, 8330, 8350, 8360, 8370, 8380, 8390, 3800, 3810, 3811, 3815, 3820, 3825, 3830, 3835, 3850, 3855, 3860, 3865, 3870, 3875, 3880, 3885, 3890, 3895, 8020, 8021, 8022, 8023, 8025, 8026, 8080, 8090, 8270, 8271, 8273, 8275, 8278, 8218, 8001, 8201, 8202, 8203, 8205, 8206, 8207, 8208, 8209, 8230, 8231, 8232, 8233, 8235, 8236, 8237, 8238, 8239, 8263, 8220, 3806, 3816, 8091, 8081, 8283, 8291, 3891, 3892, 3893, 3816, 8091, 8081, 3610, 3600, 3620, 3613, 3700, 3710, 3720, 3730, 3806, 3805, 3807, 3808, 3821, 3900, 3910, 3920, 3950, 3818, 8272, 8276, 8550, 8092, 3630, 3640, 3613, 3750, 3760, 3780, 3809, 3960, 3930, 3980, 3990, 3822,3688,3817, 3701, 3702, 3910W, MS299246AAH, MS299246AAF, MS299246AAE, N728P185824B, N728P185825B, MS314338AAB, MS312896AAB, MS312895AAB, N728P191958B, N728P191959B, N728P191960B, N728P182196B, MS197454AAA, MS196422AAA, MS195828AAA, 3100, 3110, 3120, 3150, 3101, 3300, 3200, 3612, 3903, 3931

Modulation: GFSK

Frequency.....	From 2402MHz to 2480MHz
Ratings.....	: AC 90V-240V 50/60Hz
Result.....	: PASS

TEST REPORT

- Equipment under Test** : **Treadmill**
- Model /Type** : **MS299246AAB**
- Listed Models** : 8290, 8295, 8300, 8310, 8320, 8321, 8322, 8323, 8325, 8326, 8328, 8329, 8330, 8350, 8360, 8370, 8380, 8390, 3800, 3810, 3811, 3815, 3820, 3825, 3830, 3835, 3850, 3855, 3860, 3865, 3870, 3875, 3880, 3885, 3890, 3895, 8020, 8021, 8022, 8023, 8025, 8026, 8080, 8090, 8270, 8271, 8273, 8275, 8278, 8218, 8001, 8201, 8202, 8203, 8205, 8206, 8207, 8208, 8209, 8230, 8231, 8232, 8233, 8235, 8236, 8237, 8238, 8239, 8263, 8220, 3806, 3816, 8091, 8081, 8283, 8291, 3891, 3892, 3893, 3816, 8091, 8081, 3610, 3600, 3620, 3613, 3700, 3710, 3720, 3730, 3806, 3805, 3807, 3808, 3821, 3900, 3910, 3920, 3950, 3818, 8272, 8276, 8550, 8092, 3630, 3640, 3613, 3750, 3760, 3780, 3809, 3960, 3930, 3980, 3990, 3822,3688,3817, 3701, 3702, 3910W, MS299246AAH, MS299246AAF, MS299246AAE, N728P185824B, N728P185825B, MS314338AAB, MS312896AAB, MS312895AAB, N728P191958B, N728P191959B, N728P191960B, N728P182196B, MS197454AAA, MS196422AAA, MS195828AAA, 3100, 3110, 3120, 3150, 3101, 3300, 3200, 3612, 3903, 3931
- Model Declaration** : All the models are electrical identical including the same software parameter and hardware design, same mechanical structure and design, the only difference is the model named different.
- Applicant** : **Zhejiang Lijiujiu Sports Equipment Co., Ltd.**
- Address** : No.58, Dangui South Road,Xicheng Street,Yongkang City,Zhejiang, China.
- Manufacturer** : **Zhejiang Lijiujiu Sports Equipment Co., Ltd.**
- Address** : No.58, Dangui South Road,Xicheng Street,Yongkang City,Zhejiang, China.

Test Result:	PASS
---------------------	-------------

The test report merely corresponds to the test sample.
It is not permitted to copy extracts of these test result without the written permission of the test laboratory.

Contents

1	TEST STANDARDS	4
2	SUMMARY	5
2.1	General Remarks	5
2.2	Product Description	5
2.3	Equipment Under Test	5
2.4	Short description of the Equipment under Test (EUT)	5
2.5	EUT operation mode	6
2.6	Block Diagram of Test Setup	6
2.7	Related Submittal(s) / Grant (s)	6
2.8	Modifications	6
3	TEST ENVIRONMENT	7
3.1	Address of the test laboratory	7
3.2	Test Facility	7
3.3	Environmental conditions	7
3.4	Summary of measurement results	8
3.5	Statement of the measurement uncertainty	8
3.6	Equipments Used during the Test	9
4	TEST CONDITIONS AND RESULTS	11
4.1	AC Power Conducted Emission	11
4.2	Radiated Emissions and Band Edge	14
4.3	Maximum Peak Output Power	21
4.4	Power Spectral Density	22
4.5	6dB Bandwidth	24
4.6	Out-of-band Emissions	26
4.7	Antenna Requirement	29
5	TEST SETUP PHOTOS OF THE EUT	30
6	PHOTOS OF THE EUT	31

1 TEST STANDARDS

The tests were performed according to following standards:

[FCC Rules Part 15.247](#): Frequency Hopping, Direct Spread Spectrum and Hybrid Systems that are in operation within the bands of 902-928 MHz, 2400-2483.5 MHz, and 5725-5850 MHz.

[ANSI C63.10-2013](#): American National Standard for Testing Unlicensed Wireless Devices

[KDB558074 D01 V05r02](#): Guidance for Performing Compliance Measurements on Digital Transmission Systems (DTS) Operating Under §15.247

2 SUMMARY

2.1 General Remarks

Date of receipt of test sample	:	July 10, 2024
Testing commenced on	:	July 10, 2024
Testing concluded on	:	July 19, 2024

2.2 Product Description

Product Description:	Treadmill
Model/Type reference:	MS299246AAB
Power supply:	AC 90V-240V 50/60Hz
Adapter information (Auxiliary test supplied by testing Lab)	N/A
Testing sample ID:	BSL24060039P01-R02-1# (Engineer sample), BSL24060039P01-R02-2# (Normal sample)
Bluetooth BLE	
Supported type:	Bluetooth low Energy
Modulation:	GFSK
Operation frequency:	2402MHz to 2480MHz
Channel number:	40
Channel separation:	2 MHz
Antenna type:	Spring Antenna
Antenna gain:	2.93 dBi

2.3 Equipment Under Test

Power supply system utilised

Power supply voltage	:	<input type="radio"/> 230V / 50 Hz	<input checked="" type="radio"/> 120V / 60Hz
		<input type="radio"/> 12 V DC	<input type="radio"/> 24 V DC
		<input type="radio"/> Other (specified in blank below)	

2.4 Short description of the Equipment under Test (EUT)

This is a Treadmill.
For more details, refer to the user's manual of the EUT.

2.5 EUT operation mode

The Applicant provides communication tools software(Engineer mode) to control the EUT for staying in continuous transmitting (Duty Cycle more than 98%) and receiving mode for testing .There are 40 channels provided to the EUT and Channel 00/19/39 were selected to test.

Operation Frequency:

Channel	Frequency (MHz)
00	2402
01	2404
02	2406
:	:
19	2440
:	:
37	2476
38	2478
39	2480

2.6 Block Diagram of Test Setup

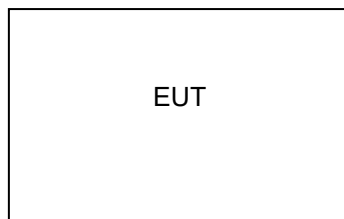

2.7 Related Submittal(s) / Grant (s)

This submittal(s) (test report) is intended for the device filing to comply with Section 15.247 of the FCC Part 15, Subpart C Rules.

2.8 Modifications

No modifications were implemented to meet testing criteria.

3 TEST ENVIRONMENT

3.1 Address of the test laboratory

BSL Testing Co., Ltd.

1/F, Building B, Xinshidai GR Park,Shiyan Street, Bao'an District, Shenzhen,Guangdong, 518052, People's Republic of China

3.2 Test Facility

FCC-Registration No.: 562200 Designation Number: CN1338

BSL Testing Co.,Ltd. has been listed on the US Federal Communications Commission list of test facilities recognized to perform electromagnetic emissions measurements.

Industry Canada Registration Number. Is: 11093A CAB identifier: CN0019

The Laboratory has been registered by Certification and Engineering Bureau of Industry Canada for radio equipment testing.

A2LA-Lab Cert. No.: 4707.01

BSL Testing Co.,Ltd. has been listed by American Association for Laboratory Accreditation to perform electromagnetic emission measurement.

The 3m-Semi anechoic test site fulfils CISPR 16-1-4 according to ANSI C63.10 and CISPR 16-1-4:2010.

3.3 Environmental conditions

During the measurement the environmental conditions were within the listed ranges:

Radiated Emission:

Temperature:	23 ° C
Humidity:	44 %
Atmospheric pressure:	950-1050mbar

AC Main Conducted testing:

Temperature:	24 ° C
Humidity:	47 %
Atmospheric pressure:	950-1050mbar

Conducted testing:

Temperature:	24 ° C
Humidity:	46 %
Atmospheric pressure:	950-1050mbar

3.4 Summary of measurement results

Test Specification clause	Test case	Test Mode	Test Channel	Recorded In Report		Test result
§15.247(e)	Power spectral density	BLE 1Mbps	<input checked="" type="checkbox"/> Lowest <input checked="" type="checkbox"/> Middle <input checked="" type="checkbox"/> Highest	BLE 1Mbps	<input checked="" type="checkbox"/> Lowest <input checked="" type="checkbox"/> Middle <input checked="" type="checkbox"/> Highest	complies
§15.247(a)(2)	Spectrum bandwidth – 6 dB bandwidth	BLE 1Mbps	<input checked="" type="checkbox"/> Lowest <input checked="" type="checkbox"/> Middle <input checked="" type="checkbox"/> Highest	BLE 1Mbps	<input checked="" type="checkbox"/> Lowest <input checked="" type="checkbox"/> Middle <input checked="" type="checkbox"/> Highest	complies
§15.247(b)(3)	Maximum output Peak power	BLE 1Mbps	<input checked="" type="checkbox"/> Lowest <input checked="" type="checkbox"/> Middle <input checked="" type="checkbox"/> Highest	BLE 1Mbps	<input checked="" type="checkbox"/> Lowest <input checked="" type="checkbox"/> Middle <input checked="" type="checkbox"/> Highest	complies
§15.247(d)	Band edge compliance conducted	BLE 1Mbps	<input checked="" type="checkbox"/> Lowest <input checked="" type="checkbox"/> Highest	BLE 1Mbps	<input checked="" type="checkbox"/> Lowest <input checked="" type="checkbox"/> Highest	complies
§15.205	Band edge compliance radiated	BLE 1Mbps	<input checked="" type="checkbox"/> Lowest <input checked="" type="checkbox"/> Highest	BLE 1Mbps	<input checked="" type="checkbox"/> Lowest <input checked="" type="checkbox"/> Highest	complies
§15.247(d)	TX spurious emissions conducted	BLE 1Mbps	<input checked="" type="checkbox"/> Lowest <input checked="" type="checkbox"/> Middle <input checked="" type="checkbox"/> Highest	BLE 1Mbps	<input checked="" type="checkbox"/> Lowest <input checked="" type="checkbox"/> Middle <input checked="" type="checkbox"/> Highest	complies
§15.247(d)	TX spurious emissions radiated	BLE 1Mbps	<input checked="" type="checkbox"/> Lowest <input checked="" type="checkbox"/> Middle <input checked="" type="checkbox"/> Highest	BLE 1Mbps	<input checked="" type="checkbox"/> Lowest <input checked="" type="checkbox"/> Middle <input checked="" type="checkbox"/> Highest	complies
§15.209(a)	TX spurious Emissions radiated Below 1GHz	BLE 1Mbps	-/-	BLE 1Mbps	-/-	complies
§15.107(a) §15.207	Conducted Emissions < 30 MHz	BLE 1Mbps	-/-	BLE 1Mbps	-/-	complies

Remark:

1. The measurement uncertainty is not included in the test result.
2. We tested all test mode and recorded worst case in report

3.5 Statement of the measurement uncertainty

The data and results referenced in this document are true and accurate. The reader is cautioned that there may be errors within the calibration limits of the equipment and facilities. The measurement uncertainty was calculated for all measurements listed in this test report acc. to TR-100028-01 "Electromagnetic compatibility and Radio spectrum Matters (ERM);Uncertainties in the measurement of mobile radio equipment characteristics; Part 1" and TR-100028-02 "Electromagnetic compatibility and Radio spectrum Matters (ERM);Uncertainties in the measurement of mobile radio equipment characteristics; Part 2 " and is documented in the BSL Testing Co., Ltd.quality system acc. to DIN EN ISO/IEC 17025. Furthermore, component and process variability of devices similar to that tested may result in additional deviation. The manufacturer has the sole responsibility of continued compliance of the device.

Hereafter the best measurement capability for BSL Testing Co., Ltd.:

Test	Range	Measurement Uncertainty	Notes
Radiated Emission	9KHz~30MHz	3.82 dB	(1)
Radiated Emission	30~1000MHz	4.06 dB	(1)
Radiated Emission	1~18GHz	5.14 dB	(1)
Radiated Emission	18-40GHz	5.38 dB	(1)
Conducted Disturbance	0.15~30MHz	2.14 dB	(1)
Transmitter power conducted	1~40GHz	0.57 dB	(1)
Conducted spurious emission	1~40GHz	1.60 dB	(1)
OBW	1~40GHz	25 Hz	(1)
PSD	1~40GHz	0.01 dBm/3KHz	(1)

- (1) This uncertainty represents an expanded uncertainty expressed at approximately the 95% confidence level using a coverage factor of k=2.

3.6 Equipments Used during the Test

Conducted Emission					
Test Equipment	Manufacturer	Model	Serial No.	Date of Cal.	Due Date
Shielding Room	ZhongYu Electron	7.3(L)x3.1(W)x2.9(H)	BSL252	2023-10-28	2024-10-27
EMI Test Receiver	R&S	ESCI 7	BSL552	2023-10-28	2024-10-27
Coaxial Switch	ANRITSU CORP	MP59B	BSL225	2023-10-28	2024-10-27
ENV216 2-L-V-NETZNACHB.DE	ROHDE&SCHWARZ	ENV216	BSL226	2023-10-28	2024-10-27
Coaxial Cable	BSL	N/A	BSL227	N/A	N/A
EMI Test Software	AUDIX	E3	N/A	N/A	N/A
Thermo meter	KTJ	TA328	BSL233	2023-10-28	2024-10-27
Absorbing clamp	Elektronik-Feinmechanik	MDS21	BSL229	2023-10-28	2024-10-27
LISN	R&S	ENV216	308	2023-10-28	2024-10-27
LISN	R&S	ENV216	314	2023-10-28	2024-10-27

Radiation Test equipment					
Test Equipment	Manufacturer	Model	Serial No.	Date of Cal.	Due Date
3m Semi- Anechoic Chamber	ZhongYu Electron	9.2(L)*6.2(W)* 6.4(H)	BSL250	2023-10-28	2024-10-27
Control Room	ZhongYu Electron	6.2(L)*2.5(W)* 2.4(H)	BSL251	N/A	N/A
EMI Test Receiver	Rohde & Schwarz	ESU26	BSL203	2023-10-28	2024-10-27
BiConiLog Antenna	SCHWARZBECK MESS-ELEKTRONIK	VULB9163	BSL214	2023-10-28	2024-10-27
Double -ridged waveguide horn	SCHWARZBECK MESS-ELEKTRONIK	BBHA 9120 D	BSL208	2023-10-28	2024-10-27
Horn Antenna	ETS-LINDGREN	3160	BSL217	2023-10-28	2024-10-27
EMI Test Software	AUDIX	E3	N/A	N/A	N/A
Coaxial Cable	BSL	N/A	BSL213	2023-10-28	2024-10-27
Coaxial Cable	BSL	N/A	BSL211	2023-10-28	2024-10-27
Coaxial cable	BSL	N/A	BSL210	2023-10-28	2024-10-27
Coaxial Cable	BSL	N/A	BSL212	2023-10-28	2024-10-27
Amplifier(100kHz-3GHz)	HP	8347A	BSL204	2023-10-28	2024-10-27
Amplifier(2GHz-20GHz)	HP	84722A	BSL206	2023-10-28	2024-10-27
Amplifier (18-26GHz)	Rohde & Schwarz	AFS33-18002 650-30-8P-44	BSL218	2023-10-28	2024-10-27
Band filter	Amindeon	82346	BSL219	2023-10-28	2024-10-27
Power Meter	Anritsu	ML2495A	BSL540	2023-10-28	2024-10-27
Power Sensor	Anritsu	MA2411B	BSL541	2023-10-28	2024-10-27
Wideband Radio Communication Tester	Rohde & Schwarz	CMW500	BSL575	2023-10-28	2024-10-27
Splitter	Agilent	11636B	BSL237	2023-10-28	2024-10-27
Loop Antenna	ZHINAN	ZN30900A	BSL534	2023-10-28	2024-10-27

Breitband hornantenne	SCHWARZBECK	BBHA 9170	BSL579	2023-10-28	2024-10-27
Amplifier	TDK	PA-02-02	BSL574	2023-10-28	2024-10-27
Amplifier	TDK	PA-02-03	BSL576	2023-10-28	2024-10-27
PSA Series Spectrum Analyzer	Rohde & Schwarz	FSP	BSL578	2023-10-28	2024-10-27

RF Conducted Test:					
Test Equipment	Manufacturer	Model	Serial No.	Date of Cal.	Due Date
MXA Signal Analyzer	Agilent	N9020A	BSL566	2023-10-28	2024-10-27
EMI Test Receiver	R&S	ESCI 7	BSL552	2023-10-28	2024-10-27
Spectrum Analyzer	Agilent	E4440A	BSL533	2023-10-28	2024-10-27
MXG vector Signal Generator	Agilent	N5182A	BSL567	2023-10-28	2024-10-27
ESG Analog Signal Generator	Agilent	E4428C	BSL568	2023-10-28	2024-10-27
USB RF Power Sensor	DARE	RPR3006W	BSL569	2023-10-28	2024-10-27
RF Switch Box	Shongyi	RFSW3003328	BSL571	2023-10-28	2024-10-27
Programmable Constant Temp & Humi Test Chamber	WEWON	WHTH-150L-40-880	BSL572	2023-10-28	2024-10-27

4 TEST CONDITIONS AND RESULTS

4.1 AC Power Conducted Emission

TEST CONFIGURATION

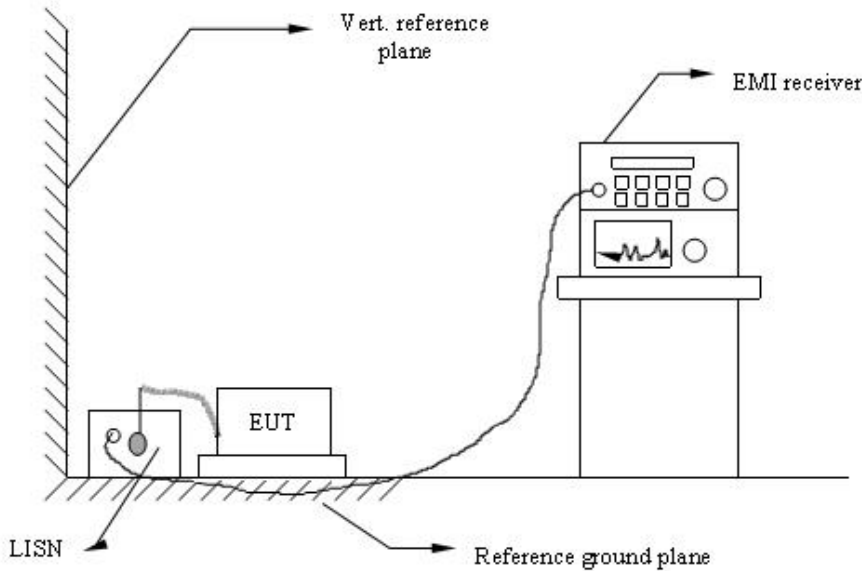

TEST PROCEDURE

- 1 The equipment was set up as per the test configuration to simulate typical actual usage per the user's manual. The EUT is a tabletop system, a wooden table with a height of 0.1 meters is used and is placed on the ground plane as per ANSI C63.10-2013.
- 2 Support equipment, if needed, was placed as per ANSI C63.10-2013
- 3 All I/O cables were positioned to simulate typical actual usage as per ANSI C63.10-2013
- 4 The EUT received power from adapter, the adapter received AC120V/60Hz and AC 240V/60Hz power through a Line Impedance Stabilization Network (LISN) which supplied power source and was grounded to the ground plane.
- 5 All support equipments received AC power from a second LISN, if any.
- 6 The EUT test program was started. Emissions were measured on each current carrying line of the EUT using a spectrum Analyzer / Receiver connected to the LISN powering the EUT. The LISN has two monitoring points: Line 1 (Hot Side) and Line 2 (Neutral Side). Two scans were taken: one with Line 1 connected to Analyzer / Receiver and Line 2 connected to a 50 ohm load; the second scan had Line 1 connected to a 50 ohm load and Line 2 connected to the Analyzer / Receiver.
- 7 Analyzer / Receiver scanned from 150 KHz to 30MHz for emissions in each of the test modes.
- 8 During the above scans, the emissions were maximized by cable manipulation.

AC Power Conducted Emission Limit

For intentional device, according to § 15.207(a) AC Power Conducted Emission Limits is as following:

Frequency range (MHz)	Limit (dBuV)	
	Quasi-peak	Average
0.15-0.5	66 to 56*	56 to 46*
0.5-5	56	46
5-30	60	50

* Decreases with the logarithm of the frequency.

TEST RESULTS

Power supply:	AC 120V/60Hz	Polarization	L
---------------	--------------	--------------	---

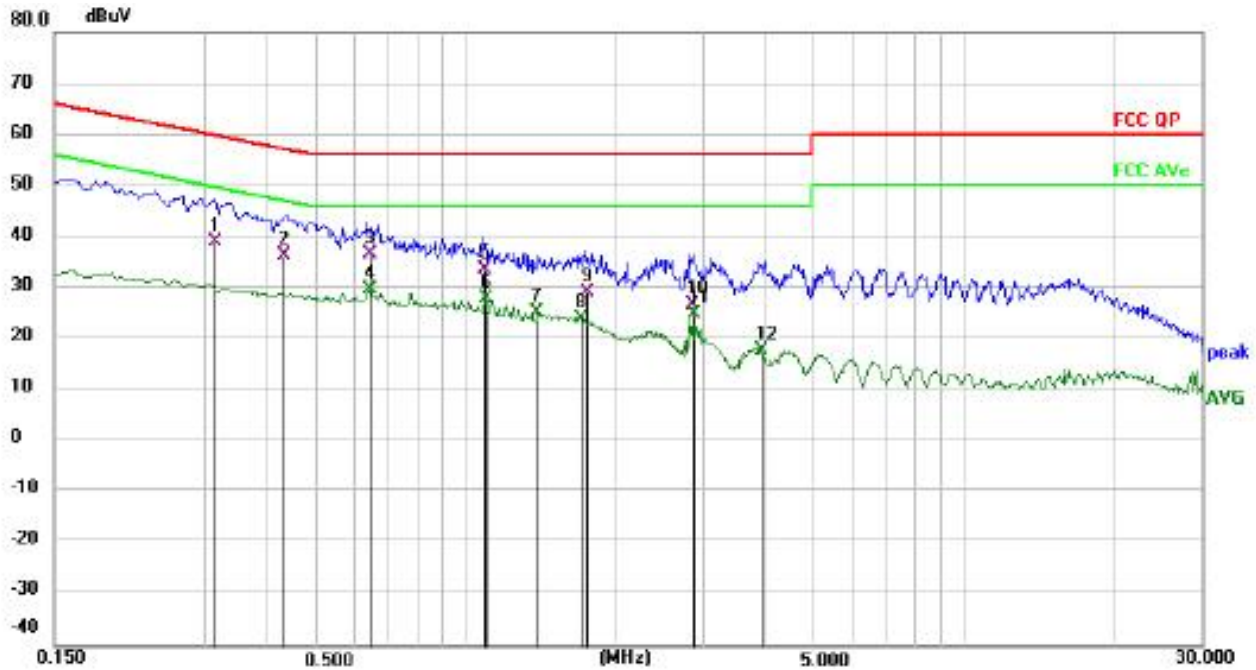

No.	Frequency (MHz)	Reading (dBuV)	Factor (dB)	Level (dBuV)	Limit (dBuV)	Margin (dB)	Detector	P/F
1	0.3122	22.28	16.71	38.99	59.91	-20.92	QP	P
2	0.4313	19.57	16.69	36.26	57.23	-20.97	QP	P
3	0.6419	19.90	16.66	36.56	56.00	-19.44	QP	P
4 *	0.6450	13.01	16.66	29.67	46.00	-16.33	AVG	P
5	1.0973	17.13	16.61	33.74	56.00	-22.26	QP	P
6	1.0995	11.41	16.61	28.02	46.00	-17.98	AVG	P
7	1.4010	8.68	16.56	25.24	46.00	-20.76	AVG	P
8	1.7025	7.55	16.53	24.08	46.00	-21.92	AVG	P
9	1.7524	12.75	16.52	29.27	56.00	-26.73	QP	P
10	2.8532	10.53	16.36	26.89	56.00	-29.11	QP	P
11	2.8770	8.49	16.36	24.85	46.00	-21.15	AVG	P
12	3.9210	1.45	16.24	17.69	46.00	-28.31	AVG	P

- Note:1).Level (dBμV)= Reading (dBμV)+ Factor (dB)
 2). Factor (dB)=insertion loss of LISN (dB) + Cable loss (dB)
 3). Margin(dB) = Limit (dBμV) - Level (dBμV)

Power supply:

AC 120V/60Hz

Polarization

N

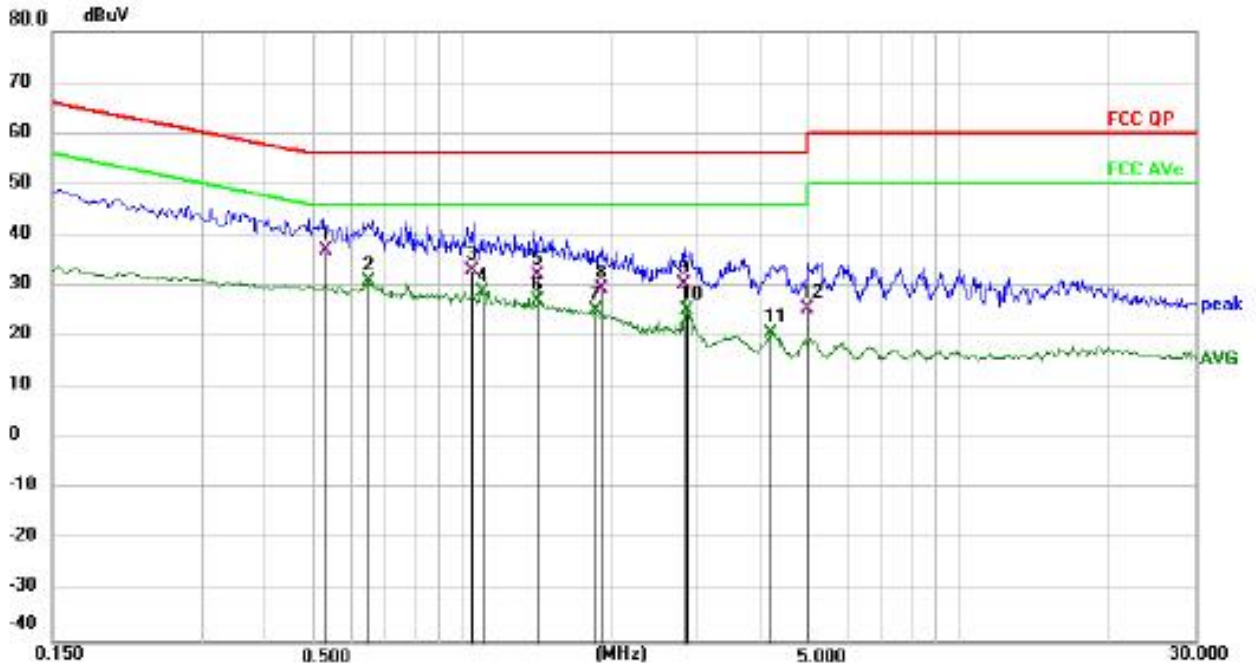

No.	Frequency (MHz)	Reading (dBuV)	Factor (dB)	Level (dBuV)	Limit (dBuV)	Margin (dB)	Detector	P/F
1	0.5284	19.38	17.51	36.89	56.00	-19.11	QP	P
2 *	0.6495	13.58	17.51	31.09	46.00	-14.91	AVG	P
3	1.0480	15.51	17.50	33.01	56.00	-22.99	QP	P
4	1.0950	11.34	17.50	28.84	46.00	-17.16	AVG	P
5	1.4175	14.58	17.49	32.07	56.00	-23.93	QP	P
6	1.4325	9.57	17.49	27.06	46.00	-18.94	AVG	P
7	1.8510	7.67	17.48	25.15	46.00	-20.85	AVG	P
8	1.9252	12.06	17.48	29.54	56.00	-26.46	QP	P
9	2.8050	12.78	17.44	30.22	56.00	-25.78	QP	P
10	2.8410	7.76	17.44	25.20	46.00	-20.80	AVG	P
11	4.2225	3.41	17.41	20.82	46.00	-25.18	AVG	P
12	4.9957	8.09	17.40	25.49	56.00	-30.51	QP	P

Note:1).Level (dBμV)= Reading (dBμV)+ Factor (dB)

2). Factor (dB)=insertion loss of LISN (dB) + Cable loss (dB)

3). Margin(dB) = Limit (dBμV) - Level (dBμV)

4.2 Radiated Emissions and Band Edge

TEST CONFIGURATION

Frequency range 9 KHz – 30MHz

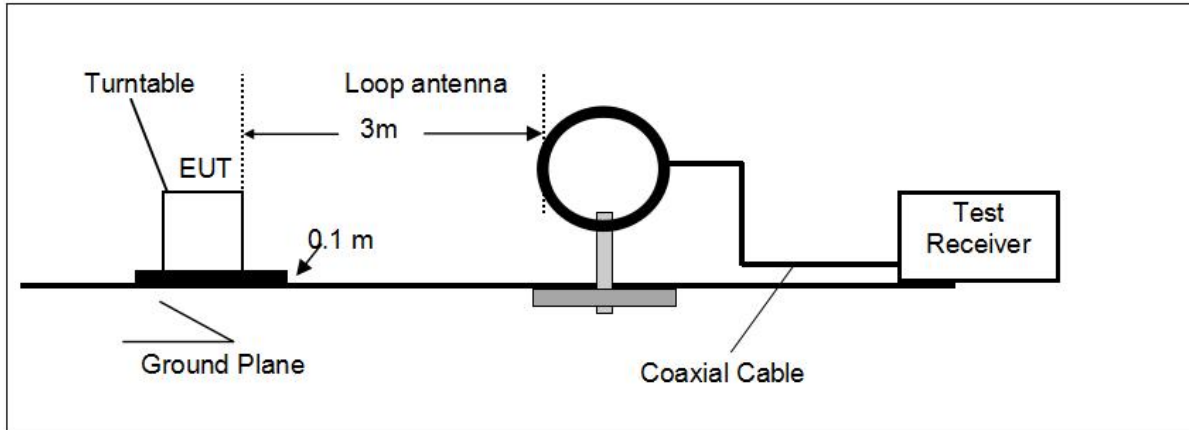

Frequency range 30MHz – 1000MHz

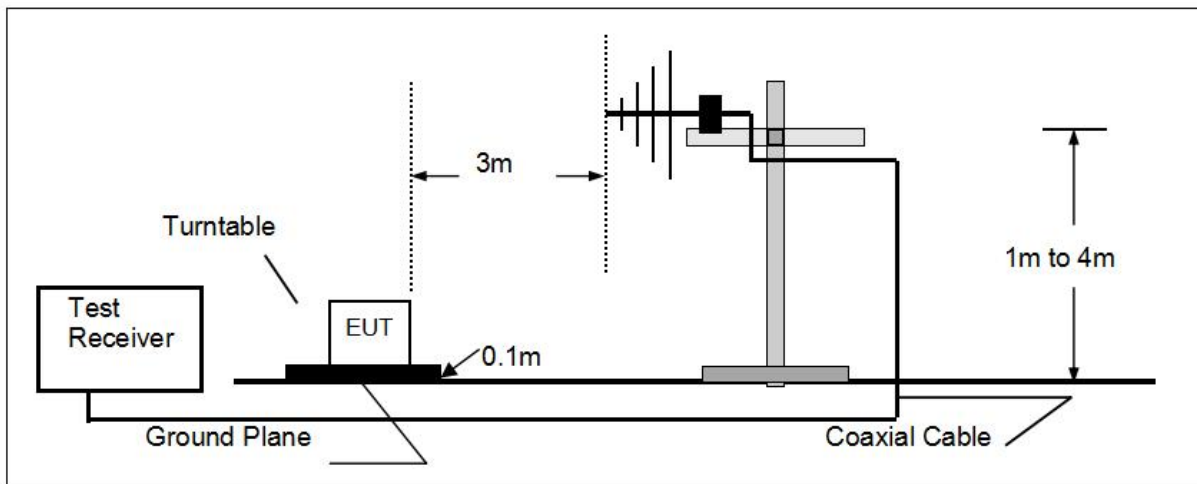

Frequency range above 1GHz-25GHz

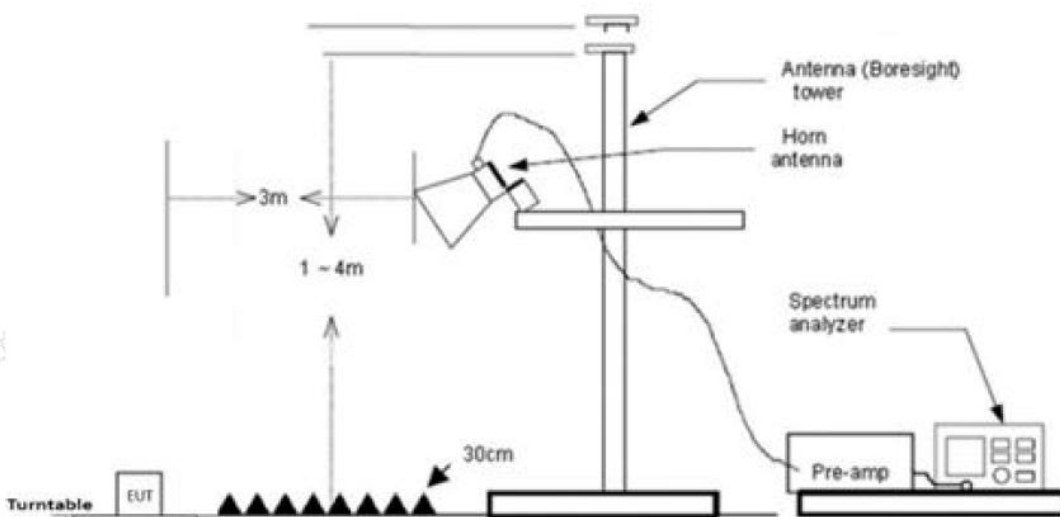

TEST PROCEDURE

1. The EUT was placed on a turn table which is 0.1m above ground plane when testing frequency range 9 KHz –1GHz;the EUT was placed on a turn table which is 1.5m above ground plane when testing frequency range 1GHz – 25GHz.
2. Maximum procedure was performed by raising the receiving antenna from 1m to 4m and rotating the turn table from 0° to 360° to acquire the highest emissions from EUT.
3. And also, each emission was to be maximized by changing the polarization of receiving antenna both horizontal and vertical.
4. Repeat above procedures until all frequency measurements have been completed.
5. The EUT minimum operation frequency was 32.768KHz and maximum operation frequency was 2480MHz.so radiated emission test frequency band from 9KHz to 25GHz.
6. The distance between test antenna and EUT as following table states:

Test Frequency range	Test Antenna Type	Test Distance
9KHz-30MHz	Active Loop Antenna	3
30MHz-1GHz	Ultra-Broadband Antenna	3
1GHz-18GHz	Double Ridged Horn Antenna	3
18GHz-25GHz	Horn Antenna	1

7. Setting test receiver/spectrum as following table states:

Test Frequency range	Test Receiver/Spectrum Setting	Detector
9KHz-150KHz	RBW=200Hz/VBW=3KHz, Sweep time=Auto	QP
150KHz-30MHz	RBW=9KHz/VBW=100KHz, Sweep time=Auto	QP
30MHz-1GHz	RBW=120KHz/VBW=1000KHz, Sweep time=Auto	QP
1GHz-40GHz	Peak Value: RBW=1MHz/VBW=3MHz, Sweep time=Auto Average Value: RBW=1MHz/VBW=10Hz, Sweep time=Auto	Peak

Field Strength Calculation

The field strength is calculated by adding the Antenna Factor and Cable Factor and subtracting the Amplifier Gain and Duty Cycle Correction Factor(if any) from the measured reading. The basic equation with a sample calculation is as follows:

$$FS = RA + AF + CL - AG$$

Where FS = Field Strength	CL = Cable Attenuation Factor (Cable Loss)
RA = Reading Amplitude	AG = Amplifier Gain
AF = Antenna Factor	

$$Transd=AF +CL-AG$$

RADIATION LIMIT

For intentional device, according to § 15.209(a), the general requirement of field strength of radiated emission from intentional radiators at a distance of 3 meters shall not exceed the following table. According to § 15.247(d), in any 100kHz bandwidth outside the frequency band in which the EUT is operating, the radio frequency power that is produced by the intentional radiator shall be at least 20dB below that in the100kHz bandwidth within the band that contains the highest level of desired power.

The pre-test have done for the EUT in three axes and found the worst emission at position shown in test setup photos.

Frequency (MHz)	Distance (Meters)	Radiated (dBµV/m)	Radiated (µV/m)
0.009-0.49	3	20log(2400/F(KHz))+40log(300/3)	2400/F(KHz)
0.49-1.705	3	20log(24000/F(KHz))+ 40log(30/3)	24000/F(KHz)
1.705-30	3	20log(30)+ 40log(30/3)	30
30-88	3	40.0	100
88-216	3	43.5	150
216-960	3	46.0	200
Above 960	3	54.0	500

TEST RESULTS

Remark:

1. This test was performed with EUT in X, Y, Z position and the worse case was found when EUT in X position.
2. BLE 1Mbps were tested at Low, Middle, and High channel and recorded worst mode at BLE 1Mbps.
3. Radiated emission test from 9 KHz to 10th harmonic of fundamental was verified, and no emission found except system noise floor in 9 KHz to 30MHz and not recorded in this report.

For 30MHz-1GHz

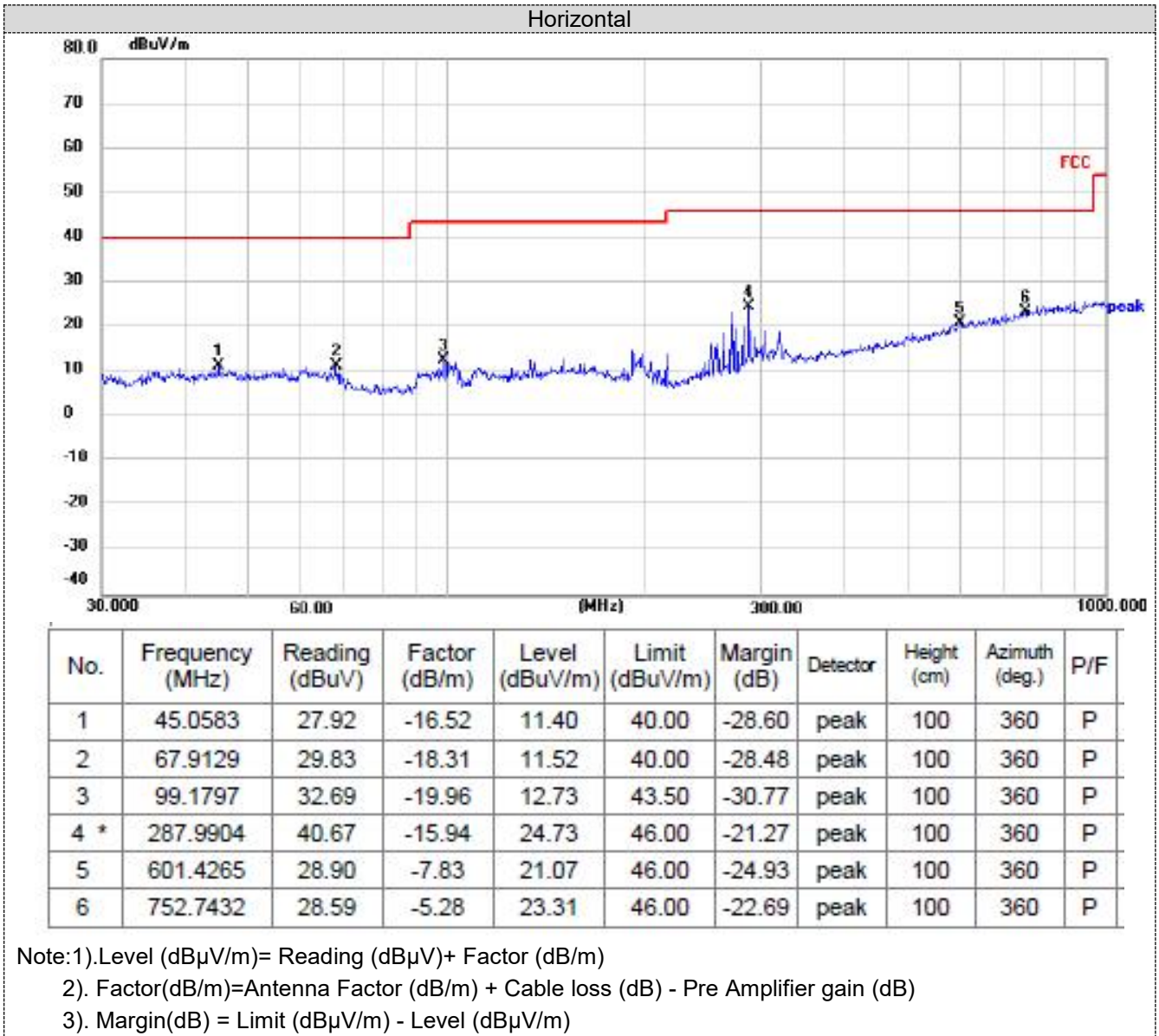

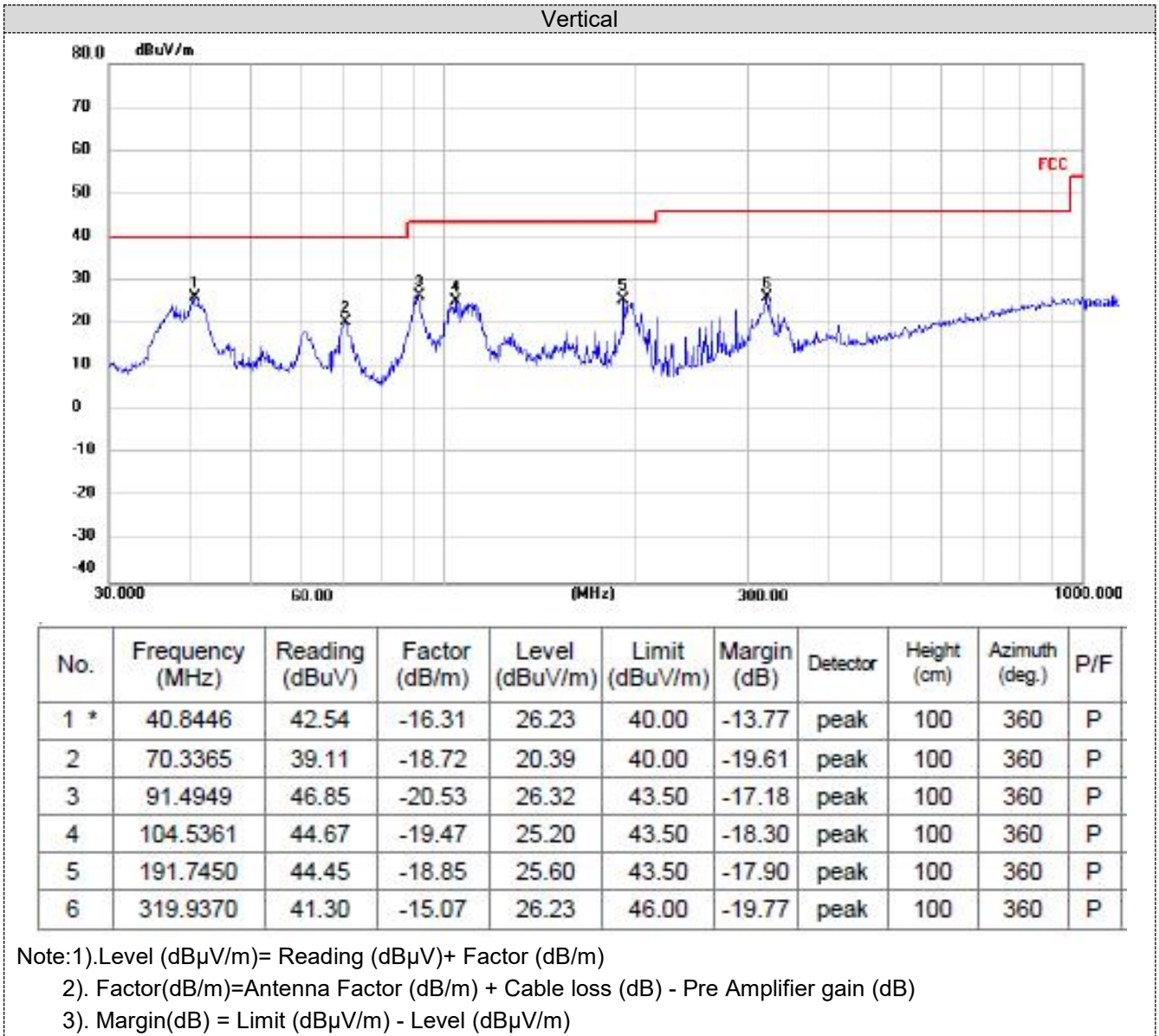

For 1GHz to 25GHz

GFSK (above 1GHz)

Frequency(MHz):			2402		Polarity:		HORIZONTAL		
Frequency (MHz)	Emission Level (dBuV/m)		Limit (dBuV/m)	Margin (dB)	Raw Value (dBuV)	Antenna Factor (dB/m)	Cable Factor (dB)	Pre-amplifier (dB)	Correction Factor (dB/m)
4804.00	57.18	PK	74	16.82	61.54	32.40	5.11	41.87	-4.36
4804.00	46.98	AV	54	7.02	51.34	32.40	5.11	41.87	-4.36
7206.00	54.85	PK	74	19.15	55.48	36.58	6.43	43.64	-0.63
7206.00	45.03	AV	54	8.97	45.66	36.58	6.43	43.64	-0.63

Frequency(MHz):			2402		Polarity:		VERTICAL		
Frequency (MHz)	Emission Level (dBuV/m)		Limit (dBuV/m)	Margin (dB)	Raw Value (dBuV)	Antenna Factor (dB/m)	Cable Factor (dB)	Pre-amplifier (dB)	Correction Factor (dB/m)
4804.00	56.62	PK	74	17.38	60.98	32.40	5.11	41.87	-4.36
4804.00	46.53	AV	54	7.47	50.89	32.40	5.11	41.87	-4.36
7206.00	54.83	PK	74	19.17	55.46	36.58	6.43	43.64	-0.63
7206.00	45.12	AV	54	8.88	45.75	36.58	6.43	43.64	-0.63

Frequency(MHz):			2440		Polarity:		HORIZONTAL		
Frequency (MHz)	Emission Level (dBuV/m)		Limit (dBuV/m)	Margin (dB)	Raw Value (dBuV)	Antenna Factor (dB/m)	Cable Factor (dB)	Pre-amplifier (dB)	Correction Factor (dB/m)
4880.00	56.92	PK	74	17.08	60.87	32.56	5.34	41.85	-3.95
4880.00	46.72	AV	54	7.28	50.67	32.56	5.34	41.85	-3.95
7320.00	55.09	PK	74	18.91	55.45	36.54	6.81	43.71	-0.36
7320.00	44.99	AV	54	9.01	45.35	36.54	6.81	43.71	-0.36

Frequency(MHz):			2440		Polarity:		VERTICAL		
Frequency (MHz)	Emission Level (dBuV/m)		Limit (dBuV/m)	Margin (dB)	Raw Value (dBuV)	Antenna Factor (dB/m)	Cable Factor (dB)	Pre-amplifier (dB)	Correction Factor (dB/m)
4880.00	56.90	PK	74	17.10	60.85	32.56	5.34	41.85	-3.95
4880.00	46.51	AV	54	7.49	50.46	32.56	5.34	41.85	-3.95
7320.00	54.99	PK	74	19.01	55.35	36.54	6.81	43.71	-0.36
7320.00	44.88	AV	54	9.12	45.24	36.54	6.81	43.71	-0.36

Frequency(MHz):			2480		Polarity:		HORIZONTAL		
Frequency (MHz)	Emission Level (dBuV/m)		Limit (dBuV/m)	Margin (dB)	Raw Value (dBuV)	Antenna Factor (dB/m)	Cable Factor (dB)	Pre-amplifier (dB)	Correction Factor (dB/m)
4960.00	56.79	PK	74	17.21	60.25	32.73	5.64	41.83	-3.46
4960.00	47.36	AV	54	6.64	50.82	32.73	5.64	41.83	-3.46
7440.00	55.57	PK	74	18.43	55.63	36.50	7.23	43.79	-0.06
7440.00	45.59	PK	54	8.41	45.65	36.50	7.23	43.79	-0.06

Frequency(MHz):			2480		Polarity:		VERTICAL		
Frequency (MHz)	Emission Level (dBuV/m)		Limit (dBuV/m)	Margin (dB)	Raw Value (dBuV)	Antenna Factor (dB/m)	Cable Factor (dB)	Pre-amplifier (dB)	Correction Factor (dB/m)
4960.00	56.99	PK	74	17.01	60.45	32.73	5.64	41.83	-3.46
4960.00	46.90	AV	54	7.10	50.36	32.73	5.64	41.83	-3.46
7440.00	55.79	PK	74	18.21	55.85	36.50	7.23	43.79	-0.06
7440.00	45.59	PK	54	8.41	45.65	36.50	7.23	43.79	-0.06

REMARKS:

1. Emission level (dBuV/m) =Raw Value (dBuV)+Correction Factor (dB/m)
2. Correction Factor (dB/m) = Antenna Factor (dB/m)+Cable Factor (dB)- Pre-amplifier
3. Margin value = Limit value- Emission level.
4. -- Mean the PK detector measured value is below average limit.
5. The other emission levels were very low against the limit.

Results of Band Edges Test (Radiated)

GFSK

Test Frequency(MHz):			Lowest channel		Polarity:		HORIZONTAL		
Frequency (MHz)	Emission Level (dBuV/m)		Limit (dBuV/m)	Margin (dB)	Raw Value (dBuV)	Antenna Factor (dB/m)	Cable Factor (dB)	Pre-amplifier (dB)	Correction Factor (dB/m)
2310.00	50.10	PK	74	23.90	60.52	27.42	4.31	42.15	-10.42
2310.00	39.82	AV	54	14.18	50.24	27.42	4.31	42.15	-10.42
2390.00	48.37	PK	74	25.63	58.66	27.55	4.35	42.19	-10.29
2390.00	38.27	AV	54	15.73	48.56	27.55	4.35	42.19	-10.29
2400.00	45.46	PK	74	28.54	55.65	27.70	4.39	42.28	-10.19
2400.00	35.05	AV	54	18.95	45.24	27.70	4.39	42.28	-10.19

Test Frequency(MHz):			Lowest channel		Polarity:		VERTICAL		
Frequency (MHz)	Emission Level (dBuV/m)		Limit (dBuV/m)	Margin (dB)	Raw Value (dBuV)	Antenna Factor (dB/m)	Cable Factor (dB)	Pre-amplifier (dB)	Correction Factor (dB/m)
2310.00	47.27	PK	74	26.73	57.69	27.42	4.31	42.15	-10.42
2310.00	37.21	AV	54	16.79	47.63	27.42	4.31	42.15	-10.42
2390.00	44.96	PK	74	29.04	55.25	27.55	4.35	42.19	-10.29
2390.00	35.13	AV	54	18.87	45.42	27.55	4.35	42.19	-10.29
2400.00	43.02	PK	74	30.98	53.21	27.70	4.39	42.28	-10.19
2400.00	32.70	AV	54	21.30	42.89	27.70	4.39	42.28	-10.19

Test Frequency(MHz):			Highest channel		Polarity:		HORIZONTAL		
Frequency (MHz)	Emission Level (dBuV/m)		Limit (dBuV/m)	Margin (dB)	Raw Value (dBuV)	Antenna Factor (dB/m)	Cable Factor (dB)	Pre-amplifier (dB)	Correction Factor (dB/m)
2483.50	45.12	PK	74	28.88	55.75	27.55	4.38	42.56	-10.63
2483.50	35.00	AV	54	19.00	45.63	27.55	4.38	42.56	-10.63
2500.00	42.50	PK	74	31.50	53.23	27.69	4.46	42.88	-10.73
2500.00	32.90	AV	54	21.10	43.63	27.69	4.46	42.88	-10.73

Test Frequency(MHz):			Highest channel		Polarity:		VERTICAL		
Frequency (MHz)	Emission Level (dBuV/m)		Limit (dBuV/m)	Margin (dB)	Raw Value (dBuV)	Antenna Factor (dB/m)	Cable Factor (dB)	Pre-amplifier (dB)	Correction Factor (dB/m)
2483.50	42.83	PK	74	31.17	53.46	27.55	4.38	42.56	-10.63
2483.50	33.02	AV	54	20.98	43.65	27.55	4.38	42.56	-10.63
2500.00	40.52	PK	74	33.48	51.25	27.69	4.46	42.88	-10.73
2500.00	31.12	AV	54	22.88	41.85	27.69	4.46	42.88	-10.73

REMARKS:

1. Emission level (dBuV/m) =Raw Value (dBuV)+Correction Factor (dB/m)
2. Correction Factor (dB/m) = Antenna Factor (dB/m)+Cable Factor (dB)- Pre-amplifier
3. Margin value = Limit value- Emission level.
4. -- Mean the PK detector measured value is below average limit.
5. The other emission levels were very low against the limit.

4.3 Maximum Peak Output Power

Limit

The Maximum Peak Output Power Measurement is 30dBm.

Test Procedure

Remove the antenna from the EUT and then connect a low loss RF cable from the antenna port to the power sensor.

Test Configuration



Test Results

Type	Channel	Output power (dBm)	Limit (dBm)	Result
GFSK 1Mbps	00	-1.652	30.00	Pass
	19	-0.856		
	39	-0.215		

Note: 1.The test results including the cable lose.S

4.4 Power Spectral Density

Limit

For digitally modulated systems, the power spectral density conducted from the intentional radiator to the antenna shall not be greater than 8 dBm in any 3 kHz band during any time interval of continuous transmission.

Test Procedure

1. Use this procedure when the maximum peak conducted output power in the fundamental emission is used to demonstrate compliance.
2. Set the RBW \geq 3 kHz.
3. Set the VBW \geq 3 \times RBW.
4. Set the span to 1.5 times the DTS channel bandwidth.
5. Detector = peak.
6. Sweep time = auto couple.
7. Trace mode = max hold.
8. Allow trace to fully stabilize.
9. Use the peak marker function to determine the maximum power level.
10. If measured value exceeds limit, reduce RBW (no less than 3 kHz) and repeat.
11. The resulting peak PSD level must be 8dBm.

Test Configuration



Test Results

Type	Channel	Power Spectral Density (dBm/3KHz)	Limit (dBm/3KHz)	Result
GFSK 1Mbps	00	-18.941	8.00	Pass
	19	-19.052		
	39	-19.886		

Test plot as follows:

BLE GFSK 1Mbps



CH00



CH19

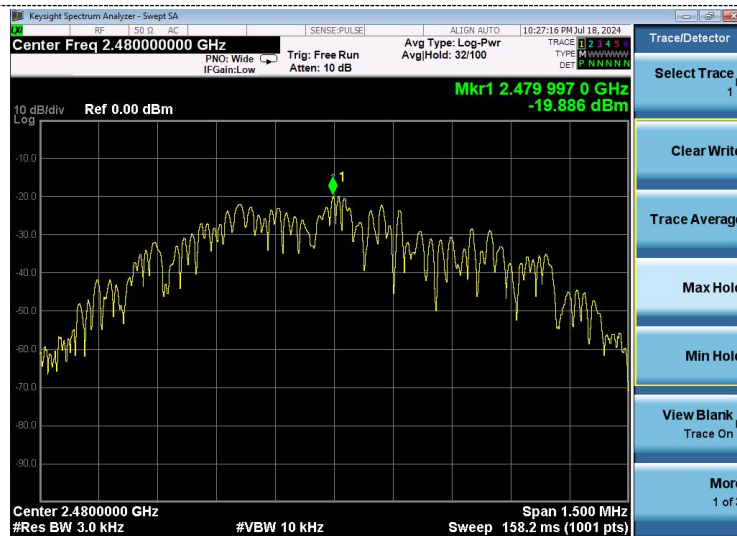

CH39

4.5 6dB Bandwidth

Limit

For digital modulation systems, the minimum 6 dB bandwidth shall be at least 500 kHz

Test Procedure

The transmitter output was connected to the spectrum analyzer through an attenuator. The bandwidth of the fundamental frequency was measured by spectrum analyzer with 100 KHz RBW and 300 KHz VBW. The 6dB bandwidth is defined as the total spectrum the power of which is higher than peak power minus 6dB.

Test Configuration



Test Results

Type	Channel	6dB Bandwidth (MHz)	Limit (KHz)	Result
GFSK 1Mbps	00	0.5068	≥500	Pass
	19	0.5058		
	39	0.5044		

Test plot as follows:

BLE GFSK 1Mbps



CH00

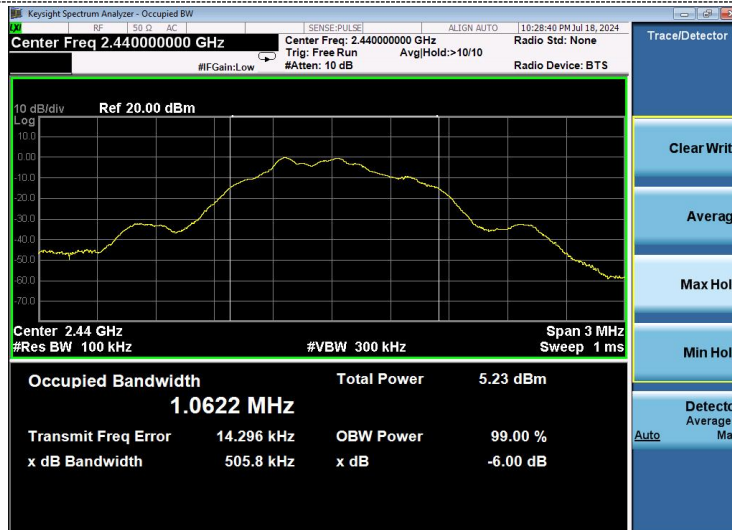

CH19



CH39

4.6 Out-of-band Emissions

Limit

In any 100 kHz bandwidth outside the frequency band in which the spread spectrum or digitally modulated intentional radiator is operating, the radio frequency power that is produced by the intentional radiator shall be at least 20 dB below that in the 100 kHz bandwidth within the band that contains the highest level of the desired power, based on either an RF conducted or a radiated measurement, provided the transmitter demonstrates compliance with the peak conducted power limits. If the transmitter complies with the conducted power limits based on the use of RMS averaging over a time interval, as permitted under paragraph (b)(3) of this section, the attenuation required under this paragraph shall be 30 dB instead of 20 dB. Attenuation below the general limits specified in §15.209(a) is not required.

Test Procedure

Connect the transmitter output to spectrum analyzer using a low loss RF cable, and set the spectrum analyzer to RBW=100 kHz, VBW= 300 kHz, peak detector, and max hold. Measurements utilizing these settings are made of the in-band reference level, band edge and out-of-band emissions.

Test Configuration



Test Results

Remark: The measurement frequency range is from 30MHz to the 10th harmonic of the fundamental frequency. The lowest, middle and highest channels are tested to verify the spurious emissions and band edge measurement data.

Test plot as follows:

GFSK 1Mbps (CH00)

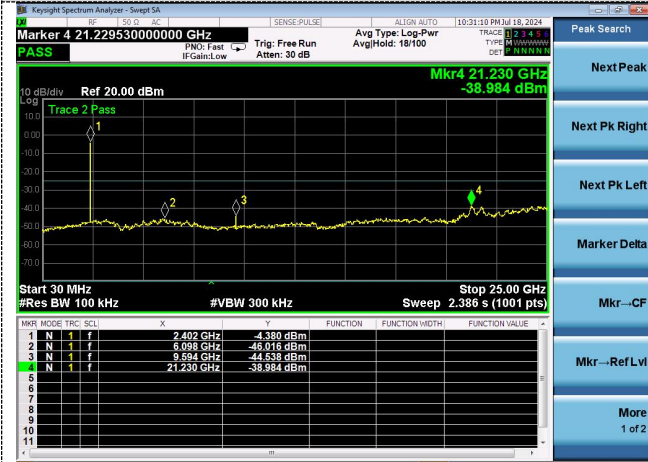

30MHz-25G

GFSK 1Mbps (CH19)

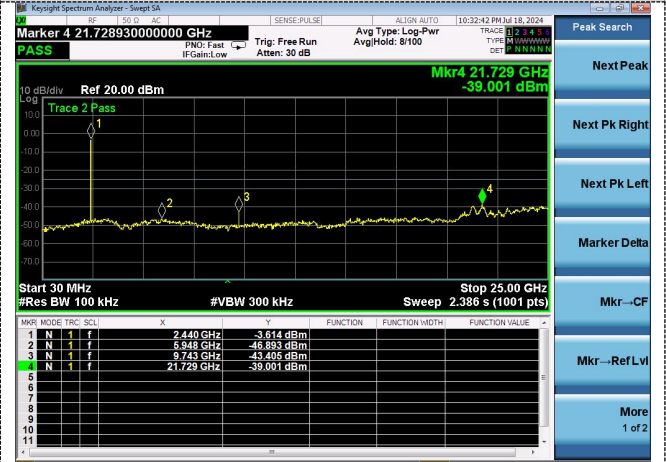

30MHz-25G

GFSK 1Mbps (CH39)

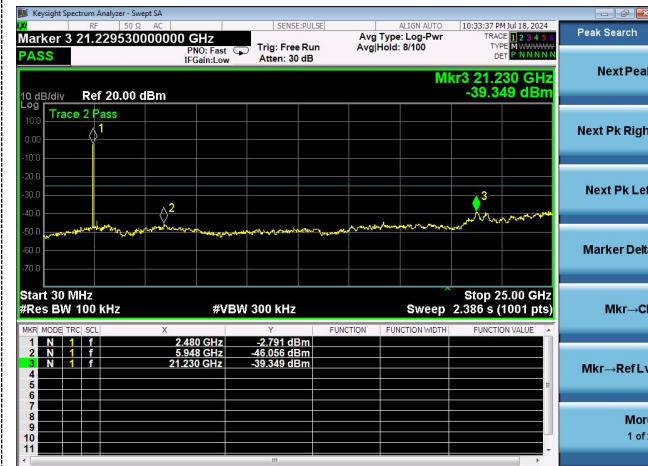

30MHz-25G

Band-edge Measurements for RF Conducted Emissions:

BLE GFSK 1Mbps

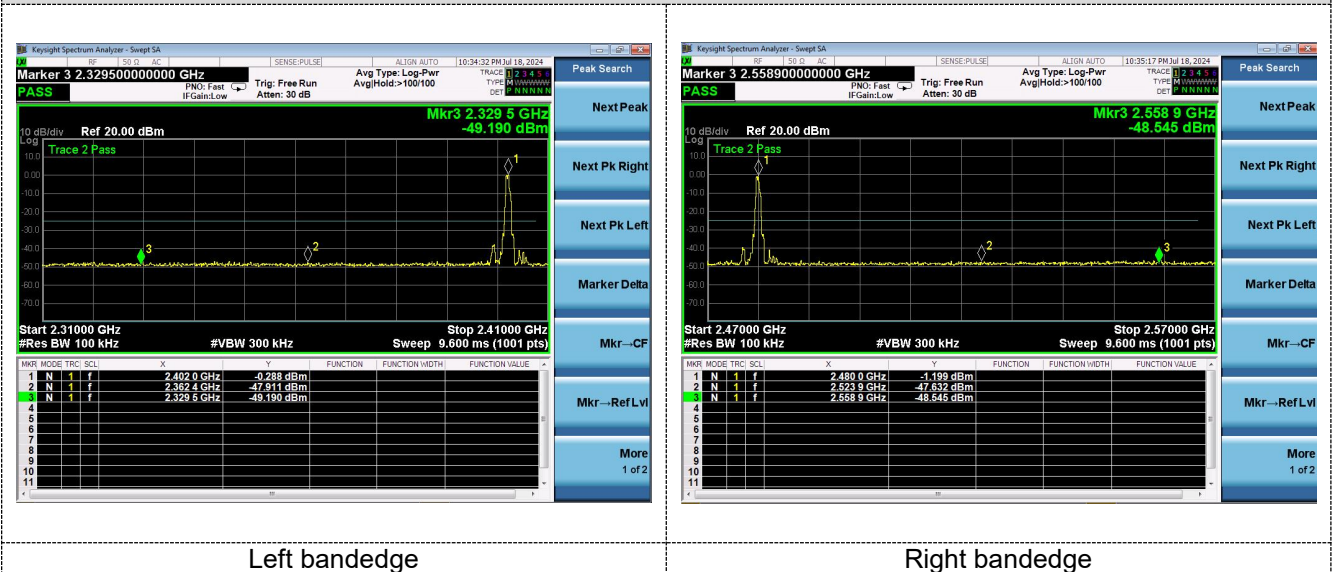

4.7 Antenna Requirement

Standard Applicable

For intentional device, according to FCC 47 CFR Section 15.203:

An intentional radiator shall be designed to ensure that no antenna other than that furnished by the responsible party shall be used with the device. The use of a permanently attached antenna or of an antenna that uses a unique coupling to the intentional radiator, the manufacturer may design the unit so that a broken antenna can be replaced by the user, but the use of a standard antenna jack or electrical connector is prohibited

FCC CFR Title 47 Part 15 Subpart C Section 15.247(c) (1) (I):

(i) Systems operating in the 2400-2483.5 MHz band that is used exclusively for fixed. Point-to-point operations may employ transmitting antennas with directional gain greater than 6dBi provided the maximum conducted output power of the intentional radiator is reduced by 1 dB for every 3 dB that the directional gain of the antenna exceeds 6dBi.

Antenna Connected Construction

The maximum gain of antenna was 2.93 dBi.

Remark: The antenna gain is provided by the customer, if the data provided by the customer is not accurate, BSL Testing Co., Ltd. does not assume any responsibility.

5 Test Setup Photos of the EUT

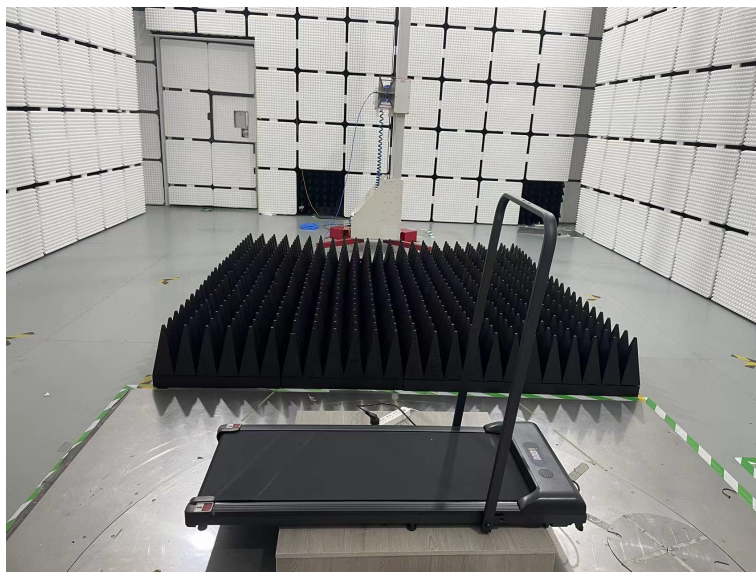
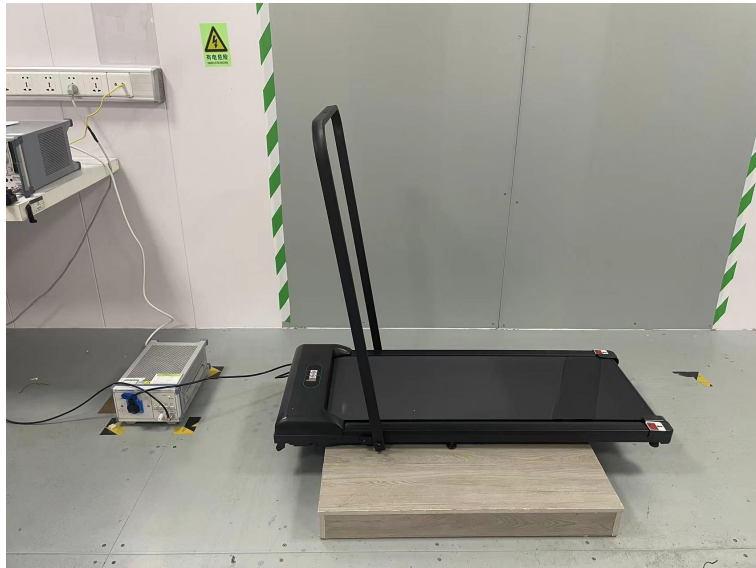
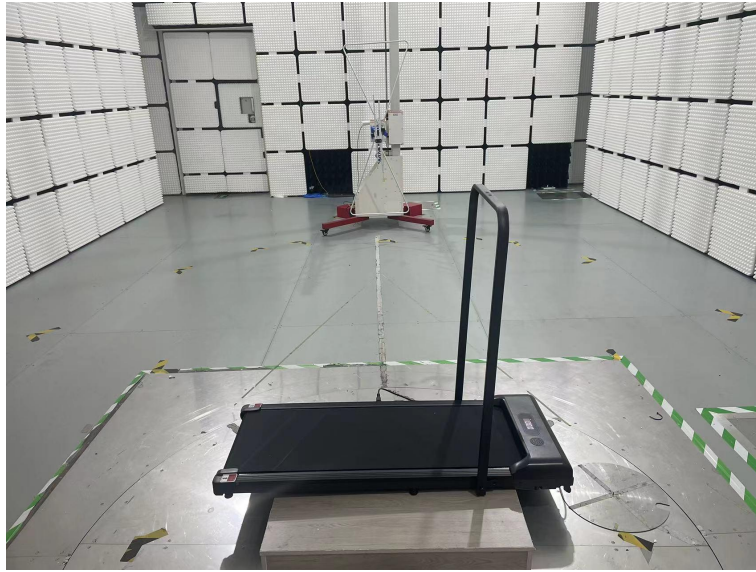

6 Photos of the EUT

Reference to the report ANNEX A of external photos and ANNEX B of internal photos.

******* End of Report *******