



FCC TEST REPORT

FCC ID: 2BFZ5-S99

On Behalf of

Hangzhou Zansheng Digital Co.,Ltd

Speaker S99

Model No.: S99, S10, S16, S18, S20, S60, S70, S80, S88, S89, S90,
TW328, TW318, TW338, TW358, TW368, P4pro, P5pro, C26, C28,
C30

Prepared for : Hangzhou Zansheng Digital Co.,Ltd
Address : 501-2, Building 17, 1008 xiangwang Street, Cangqian Street,
Yuhang District, Hangzhou City, Zhejiang Province

Prepared By : Shenzhen PSI Testing Co., Ltd.
1-2F, Building 5, Yudafu Industrial Park, No. 10, Xingye West Road,
Address : Shajing Street, Bao'an District, Shenzhen, Guangdong, China
518104

Report Number : psi2401111-C01-R01
Date of Receipt : March 11, 2024
Date of Test : March 15, 2024-April 15, 2024
Date of Report : April 16, 2024
Version Number : V0

TABLE OF CONTENTS

<u>Description</u>	<u>Page</u>
1. Summary Of Standards And Results.....	6
1.1. Description of Standards and Results	6
2. General Information.....	7
2.1. Description of Device (EUT).....	7
2.2. Accessories of Device (EUT)	8
2.3. Tested Supporting System Details	8
2.4. Block Diagram of connection between EUT and simulators	8
2.5. Test Mode Description	8
2.6. Test Conditions	9
2.7. Test Facility.....	9
2.8. Measurement Uncertainty	9
2.9. Test Equipment List	10
3. Maximum Peak Output Power	11
3.1. Limit	11
3.2. Test Procedure	11
3.3. Test Setup.....	11
3.4. Test Result.....	11
4. Bandwidth	12
4.1. Limit	12
4.2. Test Procedure	12
4.3. Test Result.....	12
5. Carrier Frequency Separation	20
5.1. Limit	20
5.2. Test Procedure	20
5.3. Test Result.....	20
6. Number Of Hopping Channel	22
6.1. Limit	22
6.2. Test Procedure	22
6.3. Test Result.....	22
7. Dwell Time	24
7.1. Test limit.....	24
7.2. Test Procedure	24
7.3. Test Result.....	24
8. Out-of-band Emissions	31
8.1. Test Limits.....	31
8.2. Test Procedure	31
8.3. Test Setup.....	31
8.4. Test Results	31
9. Radiated Emissions.....	46
9.1. Limit.....	46

9.2. Block Diagram of Test setup.....	47
9.3. Test Procedure	48
9.4. Test Results	48
10. Band Edge Test.....	55
10.1. Block Diagram of Test Setup	55
10.2. Test Limit	55
10.3. Test Procedure	55
10.4. Test Results	56
11. Power Line Conducted Emissions.....	58
11.1. Block Diagram of Test Setup	58
11.2. Limit	58
11.3. Test Procedure	58
11.4. Test Results	59
12. Antenna Requirements	62
12.1. Limit	62
12.2. Result	62
13. Photos of test setup	63
14. Photos of EUT	63

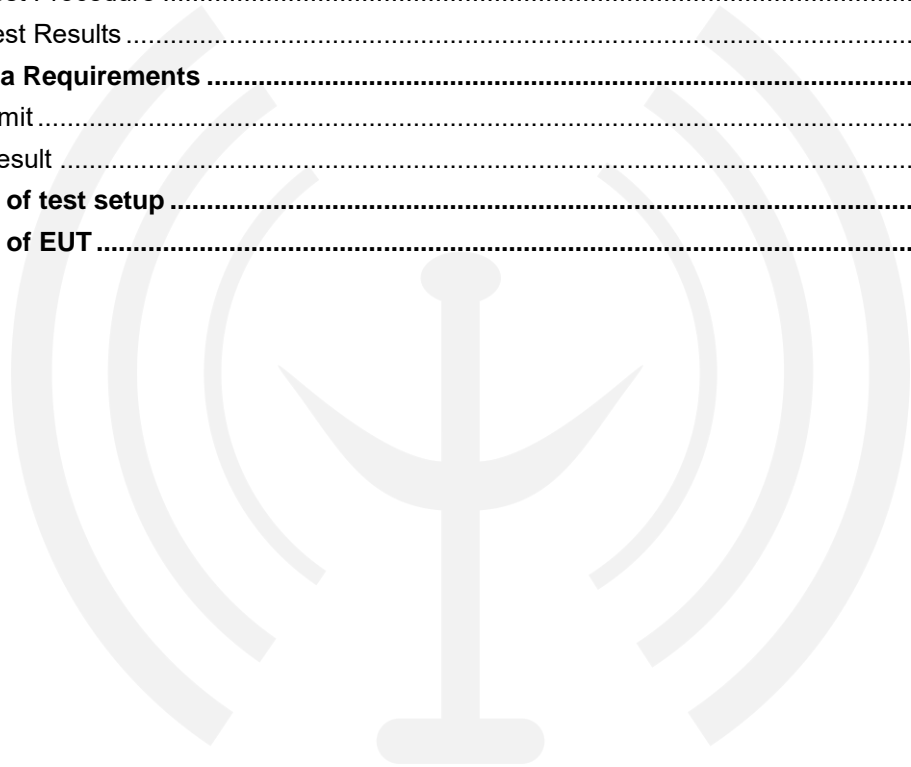

TEST REPORT DECLARATION

Applicant : Hangzhou Zansheng Digital Co.,Ltd

Address : 501-2, Building 17, 1008 xiangwang Street, Cangqian Street, Yuhang District,
Hangzhou City, Zhejiang Province

Manufacturer : Dongguan xingnan Digital Technology Co.,Ltd

Address : Room 803, No.1148 Dalang Section, Guanzhang Road, Dalang Town, Dongguan
City, Guangdong Province.

EUT Description : Speaker S99

(A) Model No. : S99, S10, S16, S18, S20, S60, S70, S80, S88, S89,
S90, TW328, TW318, TW338, TW358, TW368,
P4pro, P5pro, C26, C28, C30



(B) Trademark : N/A

Measurement Standard Used:

**FCC Rules and Regulations Part 15 Subpart C Section 15.247,
ANSI C63.10-2013**

The device described above is tested by Shenzhen PSI Testing Co., Ltd. to determine the maximum emission levels emanating from the device and the severe levels of the device can endure and its performance criterion. The test results are contained in this test report and Shenzhen PSI Testing Co., Ltd. is assumed full responsibility for the accuracy and completeness of test. Also, this report shows that the EUT is technically compliant with the FCC Part15 requirements.

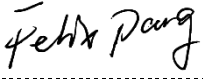
This report applies to above tested sample only. This report shall not be reproduced in parts without written approval of Shenzhen PSI Testing Co., Ltd.

Tested by (name + signature).....:	Felix Pang Test Engineer	
Approved by (name + signature).....:	Simple Guan Project Manager	
Date of issue.....:	April 16, 2024	

Revision History

Revision	Issue Date	Revisions	Revised By
V0	April 16, 2024	Initial released Issue	Felix Pang



1. Summary Of Standards And Results

1.1. Description of Standards and Results

The EUT have been tested according to the applicable standards as referenced below:

Test Item	Standards Paragraph	Result
Maximum Peak Output Power	FCC Part 15: 15.247(b)(1)	P
Bandwidth	FCC Part 15:15.247(a)(1)	P
Carrier Frequency Separation	FCC Part 15: 15.247(a)(1)	P
Number Of Hopping Channel	FCC Part 15: 15.247(a)(1)	P
Dwell Time	FCC Part 15: 15.247(a)(1)	P
Radiated Spurious Emission	FCC Part 15: 15.209 FCC Part 15: 15.205	P
Out-of-band Emissions	FCC Part 15: 15.247(d)	P
Radiated Band Edge Emission	FCC Part 15: 15.247(d)	P
Power Line Conducted Emissions	FCC Part 15: 15.207	P
Antenna requirement	FCC Part 15: 15.203	P
Note:	1. P is an abbreviation for Pass. 2. F is an abbreviation for Fail. 3. N/A is an abbreviation for Not Applicable. 4. Conclusion determination rules of this report: Unless there are clear provisions on measurement uncertainty in the standard or customer requirements, decision by actual test data without considering measurement uncertainty. 5. Measurement method usage KDB 558074 D01 15.247 Meas Guidance v05r02.	

2. General Information

2.1. Description of Device (EUT)

Description/PMN	: Speaker S99
Model	: S99, S10, S16, S18, S20, S60, S70, S80, S88, S89, S90, TW328, TW318,
Number/HVIN(s)	: TW338, TW358, TW368 , P4pro, P5pro, C26, C28, C30
Diff.	: There is no difference except the name of the model. All tests are made with the S99 model.
Test Voltage	: DC 3.7V from battery, DC 5V from USB
Radio Technology	: Bluetooth V5.0 EDR
Operation frequency	: 2402MHz-2480MHz
Modulation	: GFSK, $\pi/4$ -DQPSK
Channel No.	: 79 Channels
Channel Separation	: 1MHz
Antenna Type	: Internal antenna, Maximum Gain is -0.58dBi.
Software version	: V1.0
Hardware version	: V1.0
Intend use environment	: Residential, commercial and light industrial environment
Note	: Antenna information is provided by applicant. Testing lab is not responsible for the accuracy of the information.

2.2. Accessories of Device (EUT)

Accessories	: AC Adapter
Manufacturer	: GW-Power
Model	: GW12W-050040UU
Input	: 100-240V~ 50/630Hz 0.3A
Output	: 5.0V/0.4A 0 2.0W

2.3. Tested Supporting System Details

No.	Description	Manufacturer	Model	Serial Number
1	/	/.	/	/

2.4. Block Diagram of connection between EUT and simulators

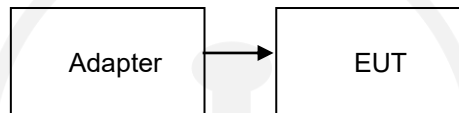

2.5. Test Mode Description

The test software used to control EUT work in Continuous TX mode, and select test channel, wireless mode

Tested mode, channel, and data rate information		
Mode	Channel	Frequency (MHz)
GFSK / Pi/4-DQPSK Carrier Tx Mode	CH0	2402
	CH39	2441
	CH78	2480
GFSK / Pi/4-DQPSK hopping on Tx Mode	CH0 to CH78	2402 to 2480
GFSK / Pi/4-DQPSK hopping off Tx Mode	CH0	2402
	CH39	2441
	CH78	2480

2.6. Test Conditions

Items	Required	Actual
Temperature range:	15-35°C	25°C
Humidity range:	25-75%	56%
Pressure range:	86-106kPa	98kPa

2.7. Test Facility

Shenzhen PSI Testing Co., Ltd.

1-2F, Building 5, Yudafu Industrial Park, No. 10, Xingye West Road, Shajing Street, Bao'an District, Shenzhen, Guangdong, China 518104

September 13, 2023 File on Federal Communication Commission

Registration Number: 916281

2.8. Measurement Uncertainty

(95% confidence levels, k=2)

Item	Uncertainty
Uncertainty for Power point Conducted Emissions Test	2.17dB
Uncertainty for Radiation Emission test in 3m chamber (below 30MHz)	3.5dB
Uncertainty for Radiation Emission test in 3m chamber (30MHz to 1GHz)	2.74dB(Polarize: V)
	2.76dB(Polarize: H)
Uncertainty for Radiation Emission test in 3m chamber (1GHz to 18GHz)	4.29dB(Polarize: V)
	4.82dB(Polarize: H)
Uncertainty for Radiation Emission test in 3m chamber (18GHz to 40GHz)	4.31 dB(Polarize: V)
	4.30 dB(Polarize: H)
Uncertainty for radio frequency	48.24KHz
Uncertainty for conducted RF Power	0.41dB

2.9. Test Equipment List							
Item	Equipment	Manufacturer	Model No.	Serial No.	Firmware Version	Last Cal.	Cal. Interval
1.	9*6*6 anechoic chamber	SKET	9*6*6	N/A	/	2022.12.20	3 Year
2.	Test Receiver	Rohde&Schwarz	ESCI 7	101032/003	4.42 SP3	2023.12.19	1 Year
3.	L.I.S.N.#1	Rohde&Schwarz	ENV216	102282	/	2023.12.19	1 Year
4.	L.I.S.N.#2	RFT	NNB111	13835240	/	2023.12.19	1 Year
5.	Loop Antenna	Schwarz beck	FMZB 1519B	00128	/	2023.04.03	2 Year
6.	Bilog Antenna	Schwarz beck	VULB 9168	01448	/	2022.12.26	2 Year
7.	Spectrum Analyzer	Rohde&Schwarz	FSV-40N	101648	3.70	2023.12.19	1 Year
8.	Horn Antenna	Schwarz beck	BBHA 9120 D	02706	/	2022.12.26	2 Year
9.	Amplifier	SKET	LAPA_01G18 G-45dB	SK20220329 01	/	2023.12.19	1 Yea
10.	Horn Antenna	Schwarz beck	BBHA 9170	00946	/	2022.12.25	2 Year
11.	Amplifier	SKET	LNPA_0118G -45	SK20200108 01	/	2023.12.19	1 Yea
12	RF Power Probe	Rohde&Schwarz	NRP-Z11	1138.3004.02 -1111533-Fz	/	2023.12.19	1 Yea
13	RF Sensor Unit	Tachoy	TR1029-2	20220428P0 08	/	2023.12.19	1 Yea
For Test Software Information							
Item	Software Name	Manufacturer			Version		
RE	EMC-I	SKET			V1.5.0.3		
CE	EMC-I	SKET			V1.5.0.3		
RF	RTS	TACHOY			V1.0.0		

3. Maximum Peak Output Power

3.1. Limit

Please refer FCC part 15.247 & RSS-247.

For frequency hopping systems operating in the 2400-2483.5 MHz band employing at least 75 non-overlapping hopping channels, and all frequency hopping systems in the 5725-5850 MHz band: 1 watt. For all other frequency hopping systems in the 2400-2483.5 MHz band: 0.125 watts, the e.i.r.p shall not exceed 4W

3.2. Test Procedure

The transmitter output is connected to the RF Power meter. The Power meter is set to the peak power detection.

3.3. Test Setup

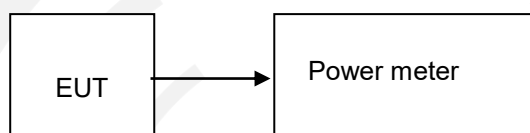

3.4. Test Result

Condition	Antenna	Modulation	Frequency (MHz)	Max. Conducted Power(dBm)	Max. Conducted Power(mW)	Limit(mW)	Result
NVNT	ANT1	1-DH1	2402.00	5.74	3.75	1000	Pass
NVNT	ANT1	1-DH1	2441.00	7.94	6.23	1000	Pass
NVNT	ANT1	1-DH1	2480.00	7.37	5.45	1000	Pass
NVNT	ANT1	2-DH1	2402.00	4.78	3.01	125	Pass
NVNT	ANT1	2-DH1	2441.00	4.79	3.01	125	Pass
NVNT	ANT1	2-DH1	2480.00	4.64	2.91	125	Pass

4. Bandwidth

4.1. Limit

Intentional radiators operating under the alternative provisions to the general emission limits, as contained in RSS-GEN, FCC Section 15.247(a)(1), must be designed to ensure that the 20 dB bandwidth of the emission, or whatever bandwidth may otherwise be specified in the specific rule section under which the equipment operates, is contained within the frequency band designated in the rule section under which the equipment is operated.

4.2. Test Procedure

The RF output of EUT was connected to the spectrum analyzer by RF cable and attenuator. The bandwidth of the fundamental frequency was measured by spectrum analyzer with 30kHz RBW and 100kHz VBW. The 20dB bandwidth is defined as the total spectrum the power of which is higher than peak power minus 20dB.

4.3. Test Result

Condition	Antenna	Modulation	Frequency (MHz)	-20dB BW(MHz)	if larger than CFS
NVNT	ANT1	1-DH1	2402.00	0.801	No
NVNT	ANT1	1-DH1	2441.00	0.799	No
NVNT	ANT1	1-DH1	2480.00	0.800	No
NVNT	ANT1	2-DH1	2402.00	1.130	Yes
NVNT	ANT1	2-DH1	2441.00	1.113	Yes
NVNT	ANT1	2-DH1	2480.00	1.115	Yes

-20dB_Bandwidth_NVNT_ANT1_1-DH1_2402

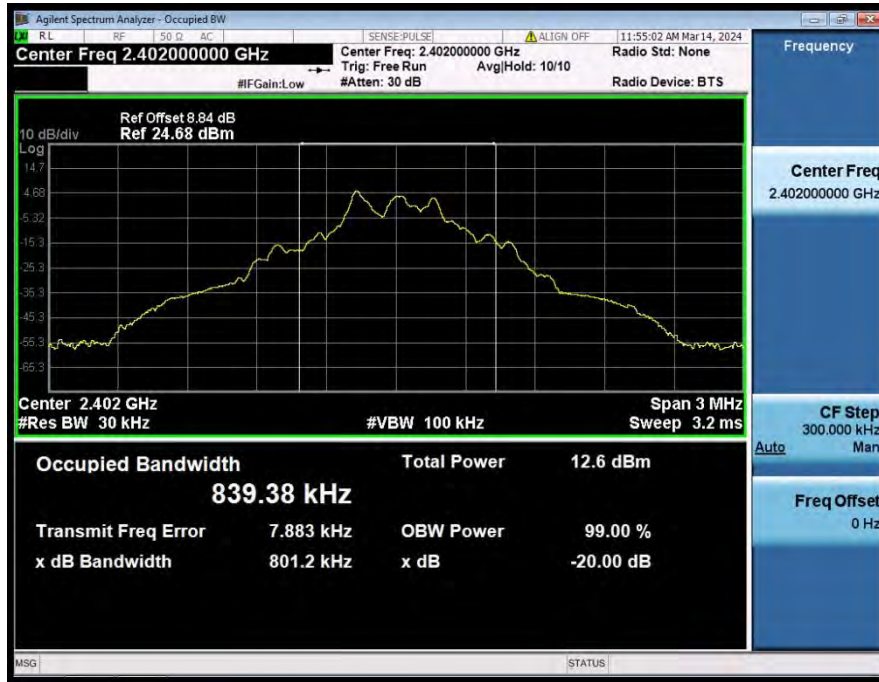

-20dB_Bandwidth_NVNT_ANT1_1-DH1_2441



-20dB_Bandwidth_NVNT_ANT1_1-DH1_2480



-20dB_Bandwidth_NVNT_ANT1_2-DH1_2402

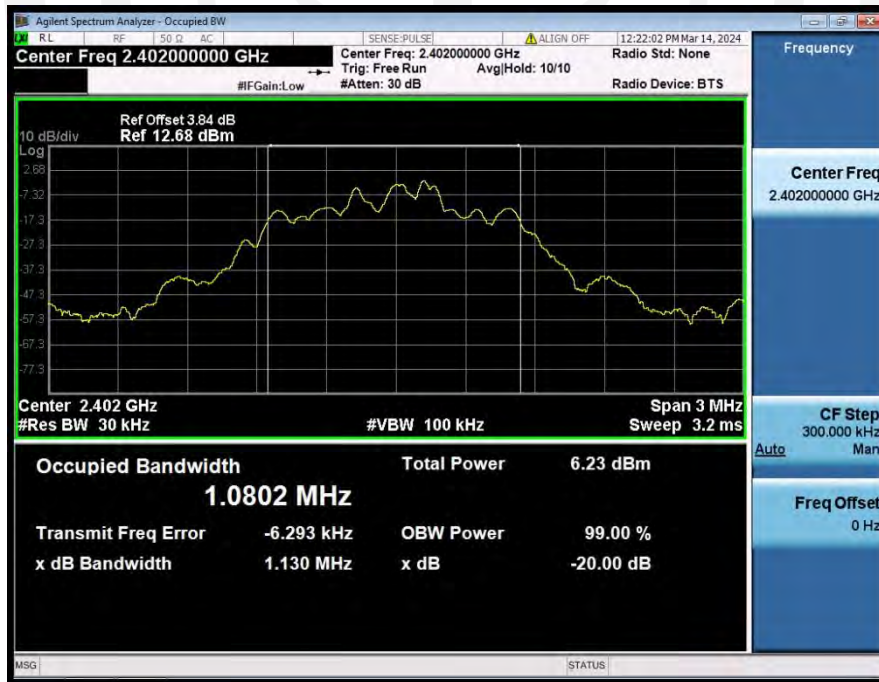

-20dB_Bandwidth_NVNT_ANT1_2-DH1_2441



-20dB_Bandwidth_NVNT_ANT1_2-DH1_2480



Condition	Antenna	Modulation	Frequency (MHz)	99% BW(MHz)
NVNT	ANT1	1-DH1	2402.00	0.840
NVNT	ANT1	1-DH1	2441.00	0.855
NVNT	ANT1	1-DH1	2480.00	0.845
NVNT	ANT1	2-DH1	2402.00	1.079
NVNT	ANT1	2-DH1	2441.00	1.073
NVNT	ANT1	2-DH1	2480.00	1.073

99%_Occupied_Bandwidth_NVNT_ANT1_1-DH1_2402

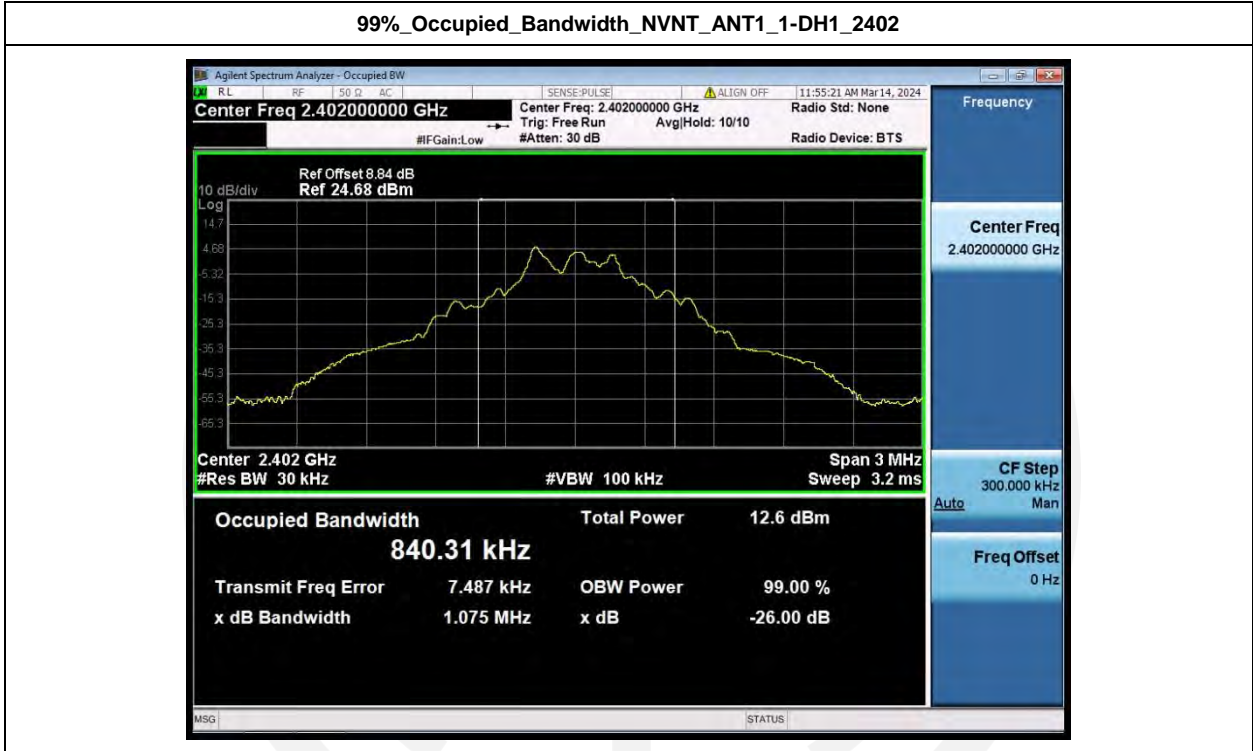

99%_Occupied_Bandwidth_NVNT_ANT1_1-DH1_2441



99%_Occupied_Bandwidth_NVNT_ANT1_1-DH1_2480



99%_Occupied_Bandwidth_NVNT_ANT1_2-DH1_2402

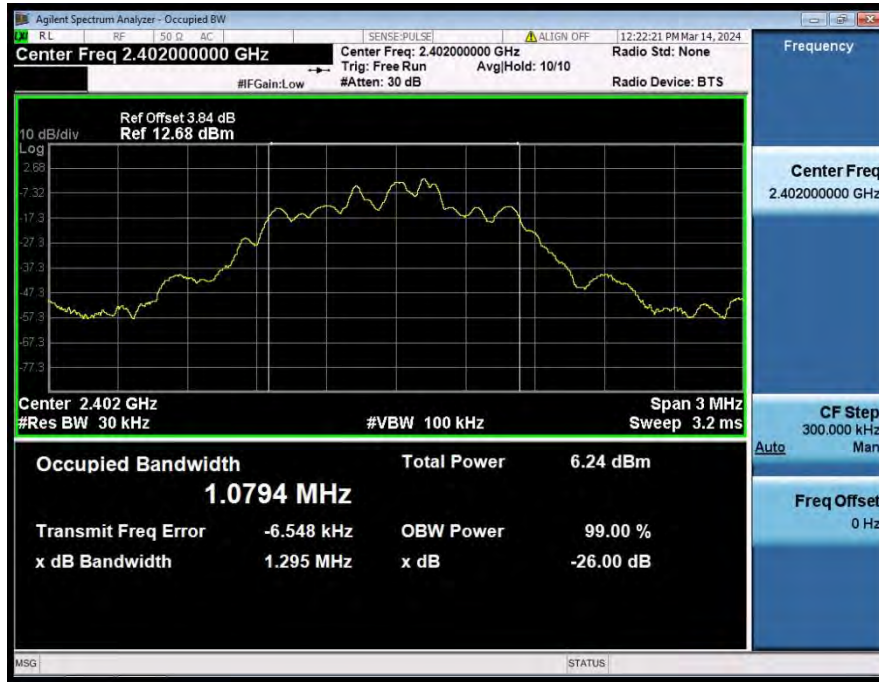

99%_Occupied_Bandwidth_NVNT_ANT1_2-DH1_2441



99%_Occupied_Bandwidth_NVNT_ANT1_2-DH1_2480



5. Carrier Frequency Separation

5.1. Limit

Frequency hopping systems shall have hopping channel carrier frequencies separated by a minimum of 25 kHz or the 20 dB bandwidth of the hopping channel, whichever is greater. Alternatively, frequency hopping systems operating in the 2400-2483.5 MHz band may have hopping channel carrier frequencies that are separated by 25 kHz or two-thirds of the 20 dB bandwidth of the hopping channel, whichever is greater, provided the systems operate with an output power no greater than 125 mW

5.2. Test Procedure

The RF output of EUT was connected to the spectrum analyzer by RF cable and attenuator. The carrier frequency was measured by spectrum analyzer with 100kHz RBW and 300kHz VBW.

5.3. Test Result

Condition	Antenna	Modulation	Frequency(MHz)	Hopping NO.0 (MHz)	Hopping NO.1 (MHz)	Carrier Frequencies Separation(MHz)	Limit(MHz)	Result
NVNT	ANT1	1-DH1	2441.00	2440.834	2441.833	1.00	0.799	Pass
NVNT	ANT1	2-DH1	2441.00	2441.164	2442.166	1.00	0.742	Pass

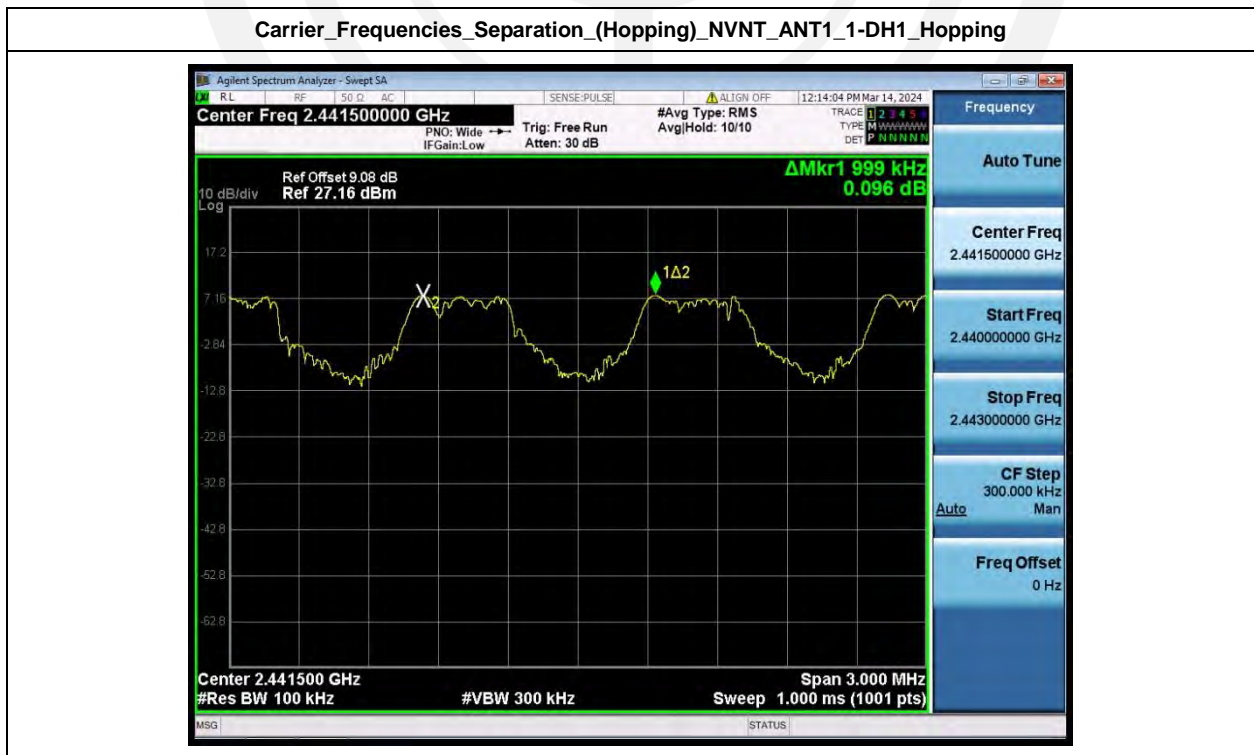

Carrier_Frequencies_Separation_(Hopping)_NVNT_ANT1_2-DH1_Hopping



6. Number Of Hopping Channel

6.1. Limit

Frequency hopping systems in the 2400-2483.5 MHz band shall use at least 15 channels

6.2. Test Procedure

The RF output of EUT was connected to the spectrum analyzer by RF cable and attenuator. The number of hopping channel was measured by spectrum analyzer with 100kHz RBW and 300KHz VBW.

6.3. Test Result

Condition	Antenna	Modulation	Hopping Num	Limit	Result
NVNT	ANT1	1-DH1	79	15	Pass
NVNT	ANT1	2-DH1	79	15	Pass



Number_of_Hopping_Channel_(Hopping)_NVNT_ANT1_2-DH1_Hopping



7. Dwell Time

7.1. Test limit

Please refer FCC part 15.247 & RSS-247.

Frequency hopping systems operating in the 2400MHz-2483.5 MHz. The average time of occupancy on any frequency shall not greater than 0.4 s within period of 0.4 seconds multiplied by the number of hopping channel employed.

7.2. Test Procedure

- 7.2.1. Place the EUT on the table and set it in transmitting mode.
- 7.2.2. Remove the antenna from the EUT and then connect a low loss RF cable from the antenna port to the spectrum analyzer.
- 7.2.3. Set center frequency of spectrum analyzer = operating frequency.
- 7.2.4. Set the spectrum analyzer as RBW, VBW=1MHz, Span = 0Hz, Sweep = auto.
- 7.2.5. Repeat above procedures until all frequency measured were complete.

7.3. Test Result

Note:

1. The test period: $T = 0.4 \text{ Second/Channel} \times 79 \text{ Channel} = 31.6 \text{ s}$
2. Dwell Time = Pulse Time * Hops Number

Condition	Antenna	Packet Type	Pulse Time(ms)	Hops	Dwell Time(ms)	Limit(s)	Result
NVNT	ANT1	1-DH1	0.407	319.00	129.833	0.40	Pass
NVNT	ANT1	2-DH1	0.407	318.00	129.426	0.40	Pass
NVNT	ANT1	1-DH3	1.663	168.00	279.384	0.40	Pass
NVNT	ANT1	1-DH5	2.911	97.00	282.367	0.40	Pass
NVNT	ANT1	2-DH3	1.663	162.00	269.406	0.40	Pass
NVNT	ANT1	2-DH5	2.911	112.00	326.032	0.40	Pass

Dwell_Time_(Hopping)_NVNT_ANT1_1-DH1_2441_One_Burst_Time

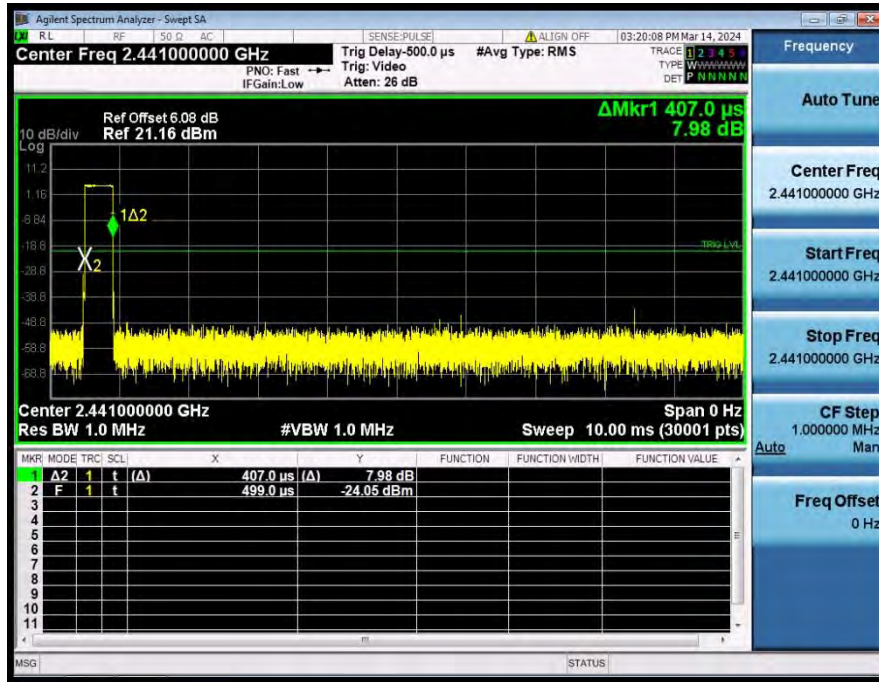

Dwell_Time_(Hopping)_NVNT_ANT1_1-DH1_2441_Accumulated

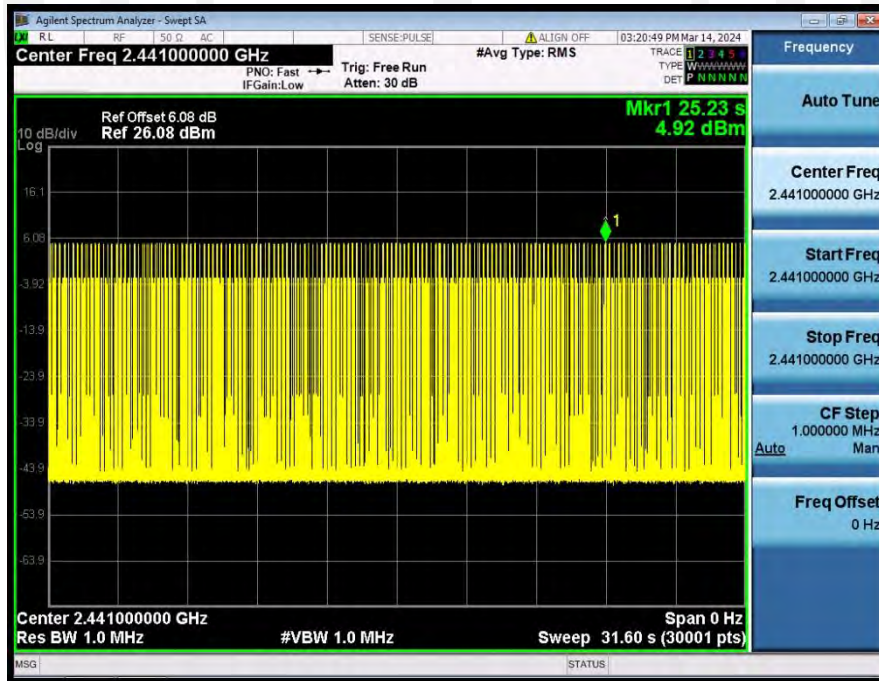

Dwell_Time_(Hopping)_NVNT_ANT1_2-DH1_2441_One_Burst_Time

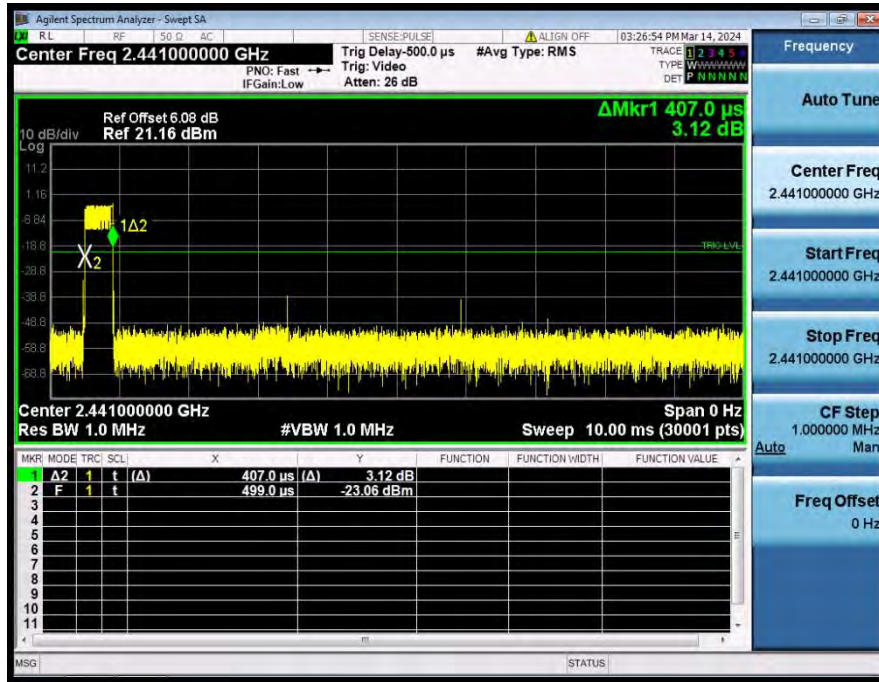

Dwell_Time_(Hopping)_NVNT_ANT1_2-DH1_2441_Accumulated

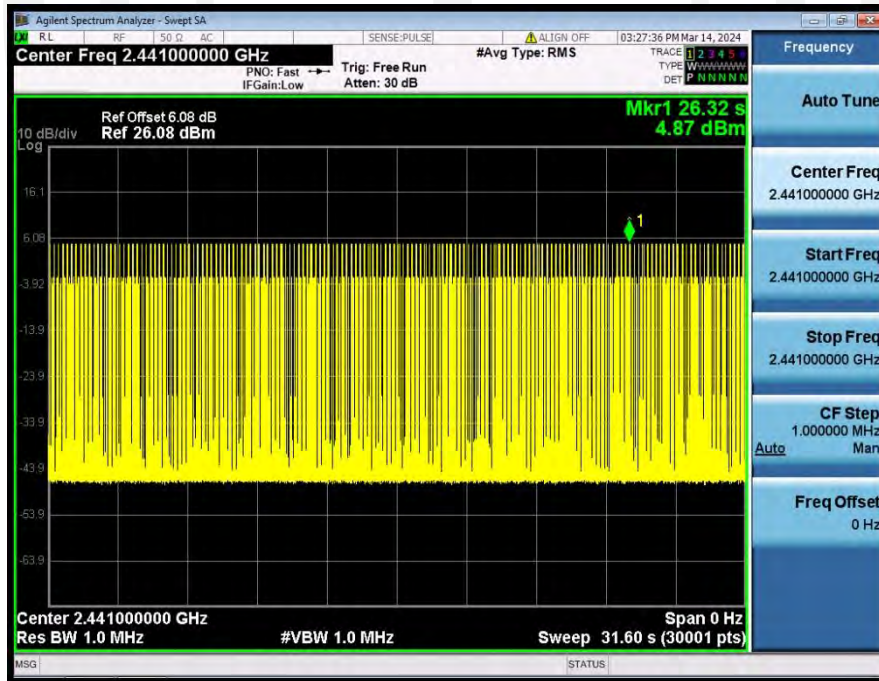

Dwell_Time_(Hopping)_NVNT_ANT1_1-DH3_2441_One_Burst_Time

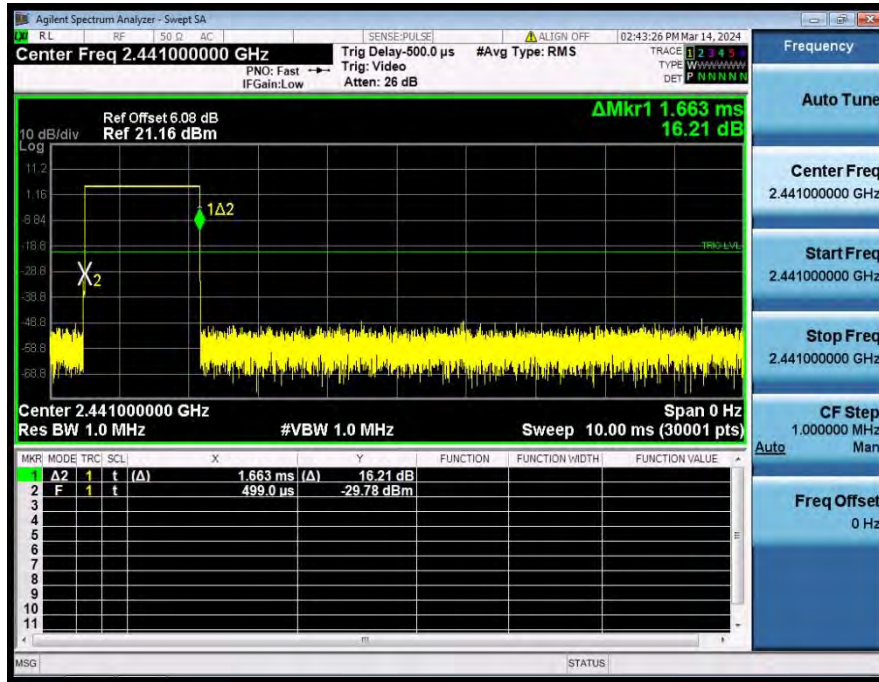

Dwell_Time_(Hopping)_NVNT_ANT1_1-DH3_2441_Accumulated

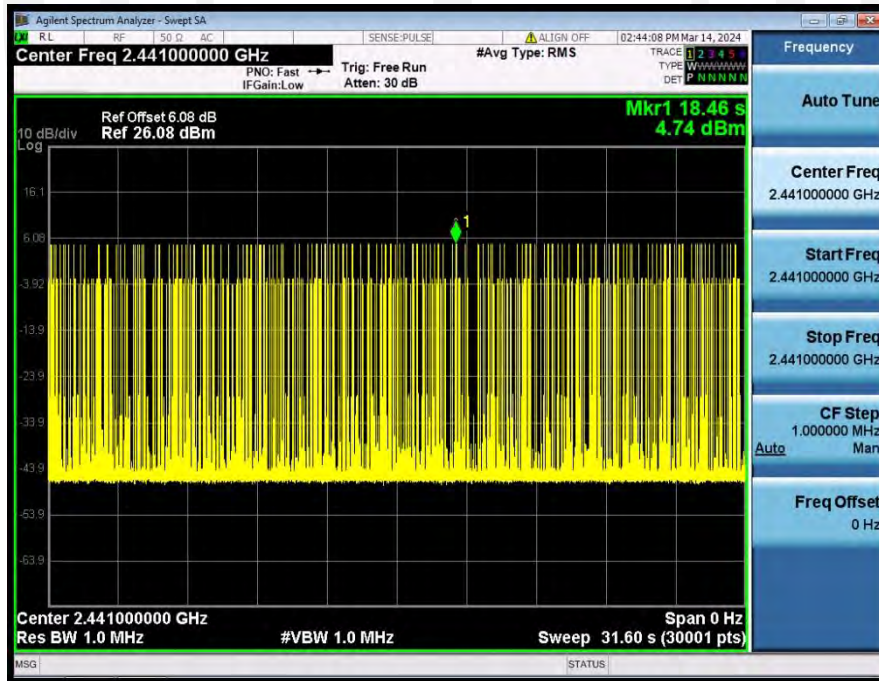

Dwell_Time_(Hopping)_NVNT_ANT1_1-DH5_2441_One_Burst_Time

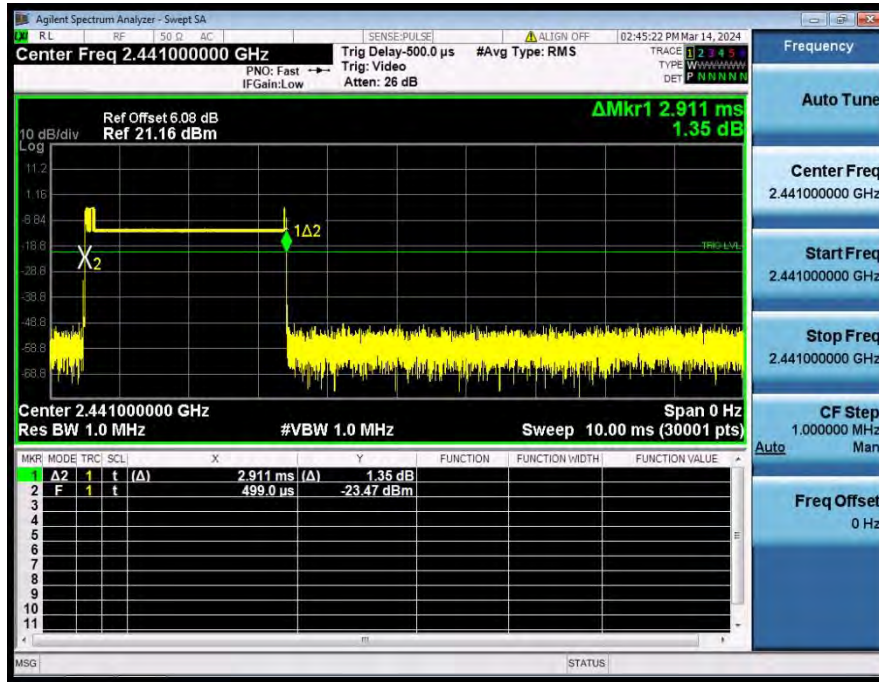

Dwell_Time_(Hopping)_NVNT_ANT1_1-DH5_2441_Accumulated



Dwell_Time_(Hopping)_NVNT_ANT1_2-DH3_2441_One_Burst_Time

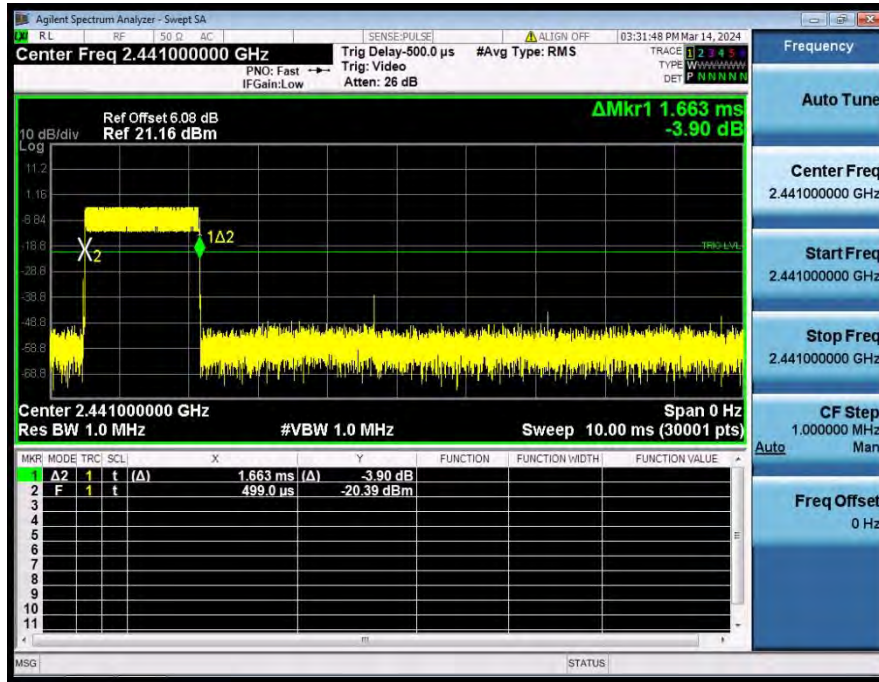

Dwell_Time_(Hopping)_NVNT_ANT1_2-DH3_2441_Accumulated

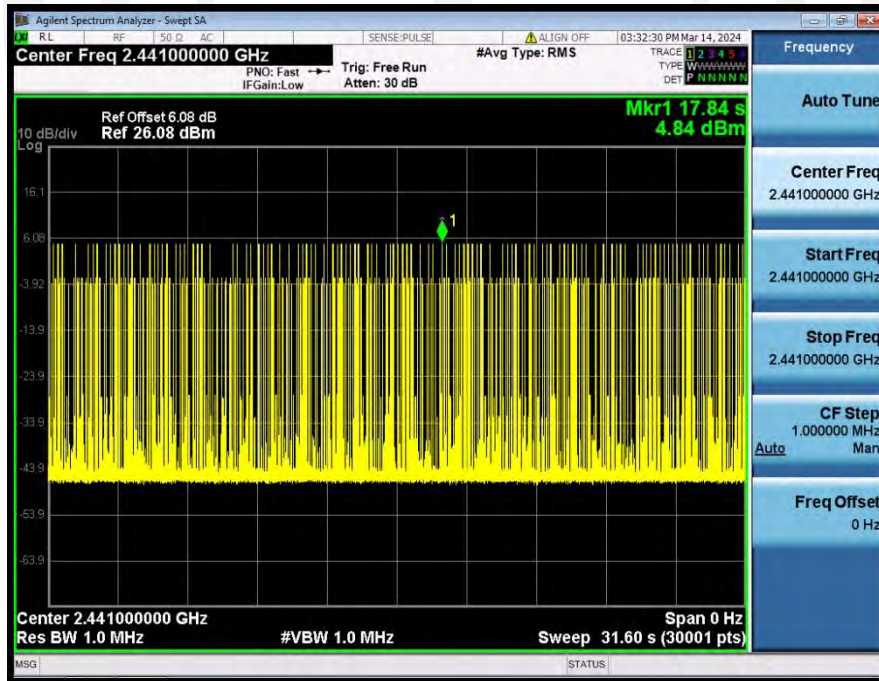

Dwell_Time_(Hopping)_NVNT_ANT1_2-DH5_2441_One_Burst_Time

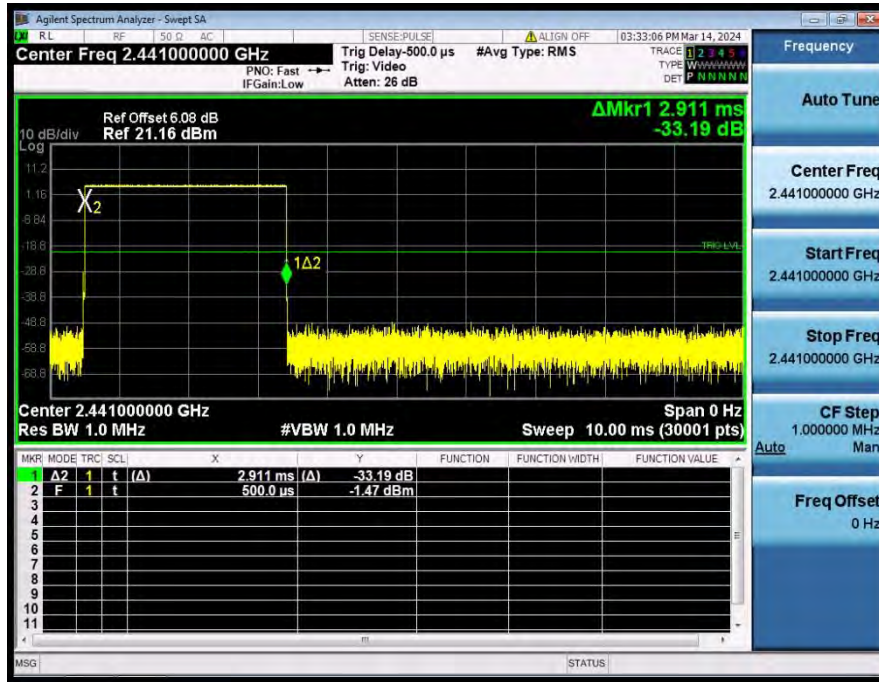

Dwell_Time_(Hopping)_NVNT_ANT1_2-DH5_2441_Accumulated

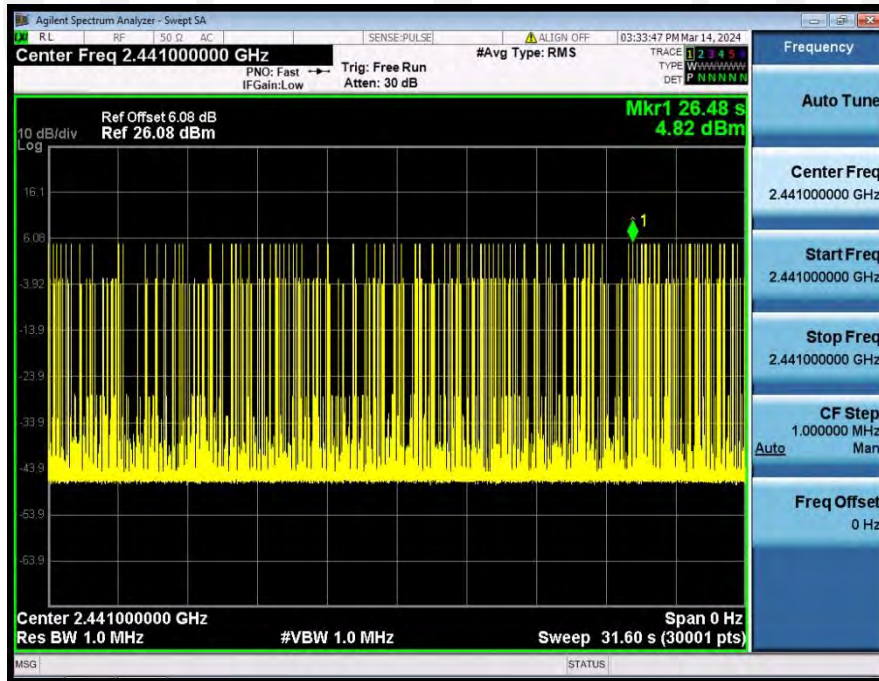

8. Out-of-band Emissions

8.1. Test Limits

In any 100 kHz bandwidth outside the frequency band in which the spread spectrum or digitally modulated intentional radiator is operating, the radio frequency power that is produced by the intentional radiator shall be at least 20 dB below that in the 100 kHz bandwidth within the band that contains the highest level of the desired power, based on either an RF conducted or a radiated measurement, provided the transmitter demonstrates compliance with the peak conducted power limits. If the transmitter complies with the conducted power limits based on the use of RMS averaging over a time interval, as permitted under paragraph (b)(3) of this section, the attenuation required under this paragraph shall be 30 dB instead of 20 dB. Attenuation below the general limits specified in FCC Part 15.209(a) is not required.

8.2. Test Procedure

Connect the transmitter output to spectrum analyzer using a low loss RF cable, and set the spectrum analyzer to RBW=100 kHz, VBW= 300 kHz, peak detector, and max hold. Measurements utilizing these settings are made of the in-band reference level, band edge and out-of-band emissions.

8.3. Test Setup

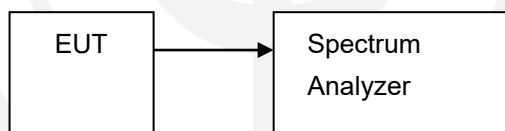

8.4. Test Results

PASS.

The test results are listed in next pages.

Band Edge: Pass

1_Reference_Level_NVNT_ANT1_1-DH1_2402

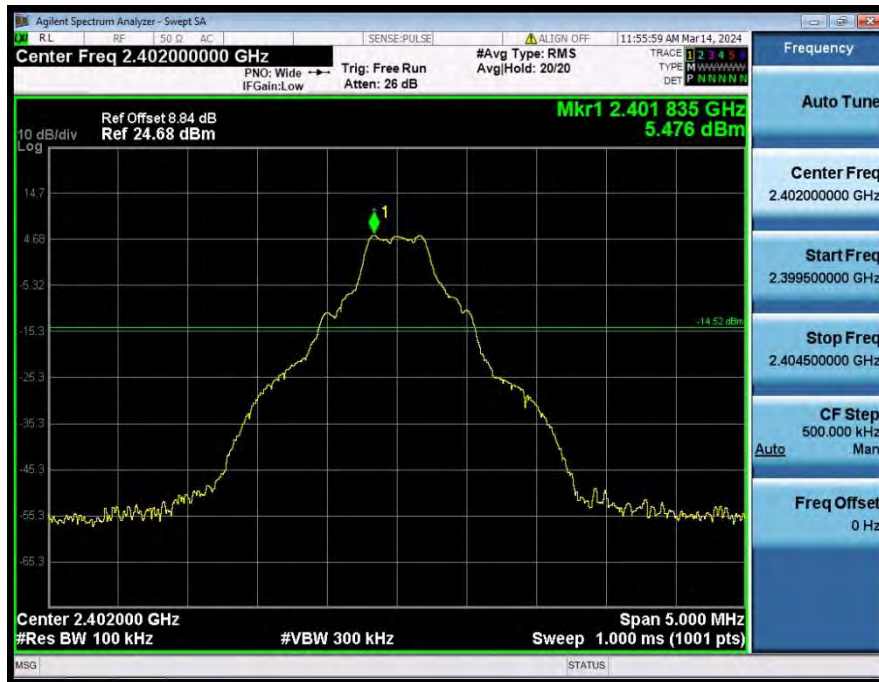

2_Bandedge_NVNT_ANT1_1-DH1_2402

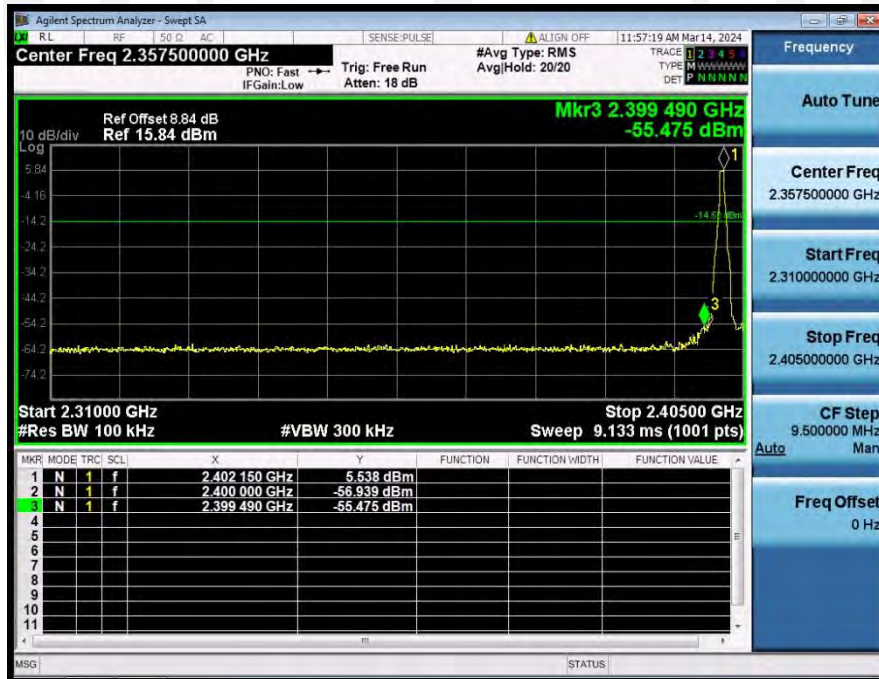

1_Reference_Level_Hopping_NVNT_ANT1_1-DH1_Hopping

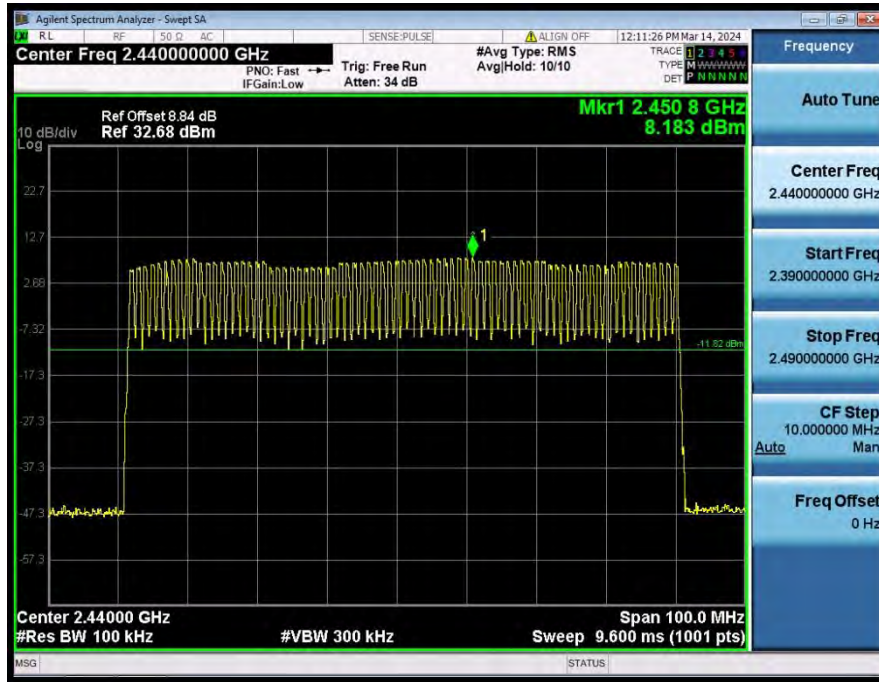

2_Band_Edge_(Hopping)_NVNT_ANT1_1-DH1_Hopping

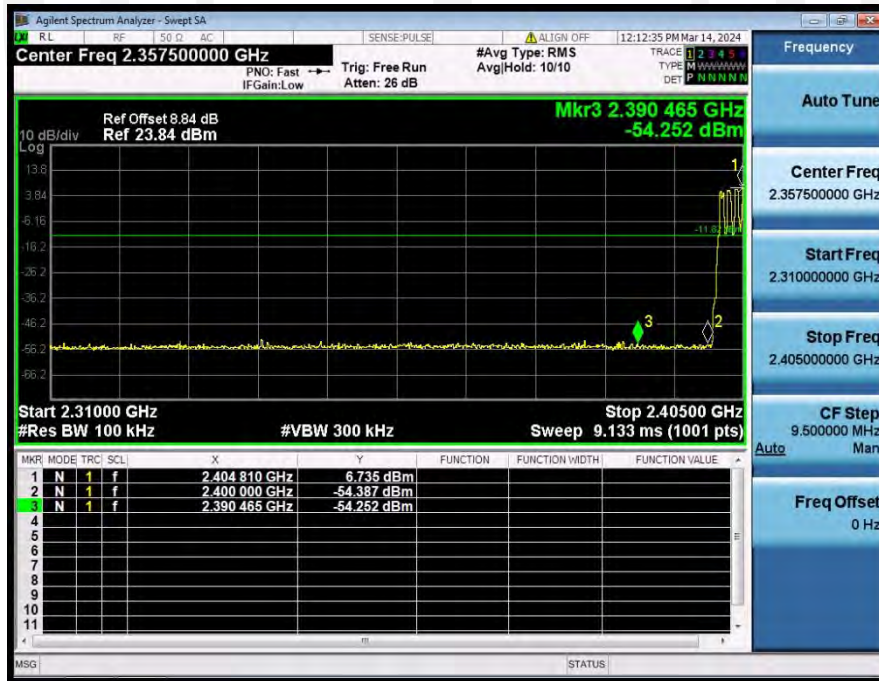

1_Reference_Level_NVNT_ANT1_1-DH1_2480



2_Bandedge_NVNT_ANT1_1-DH1_2480

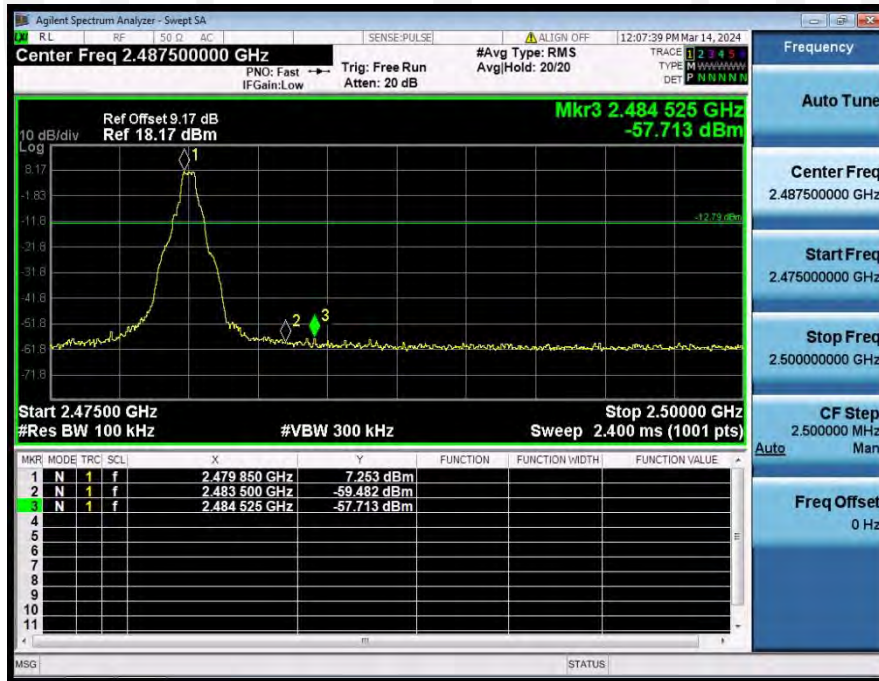

1_Reference_Level_Hopping_NVNT_ANT1_1-DH1_Hopping

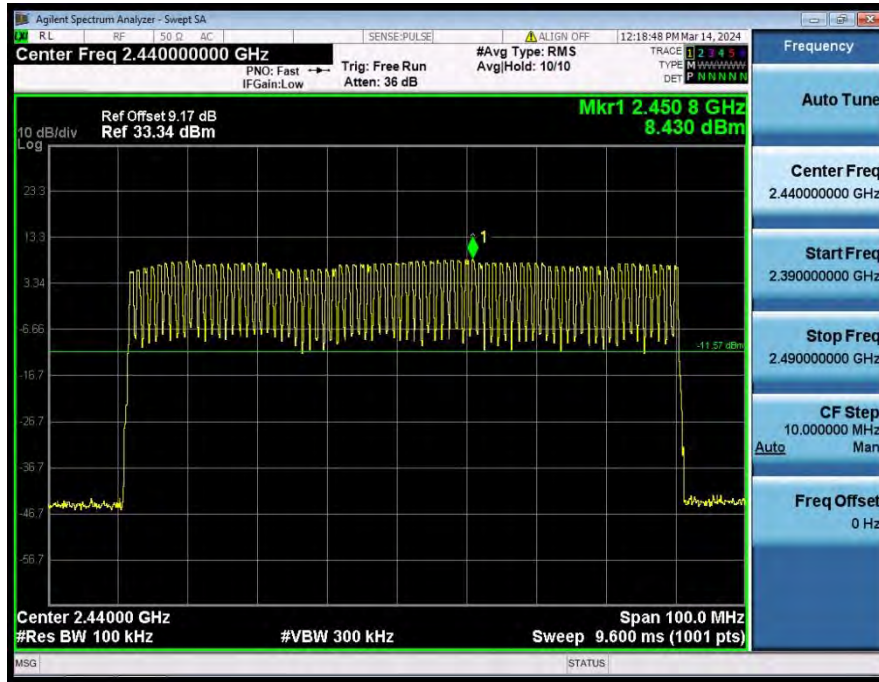

2_Band_Edge_(Hopping)_NVNT_ANT1_1-DH1_Hopping

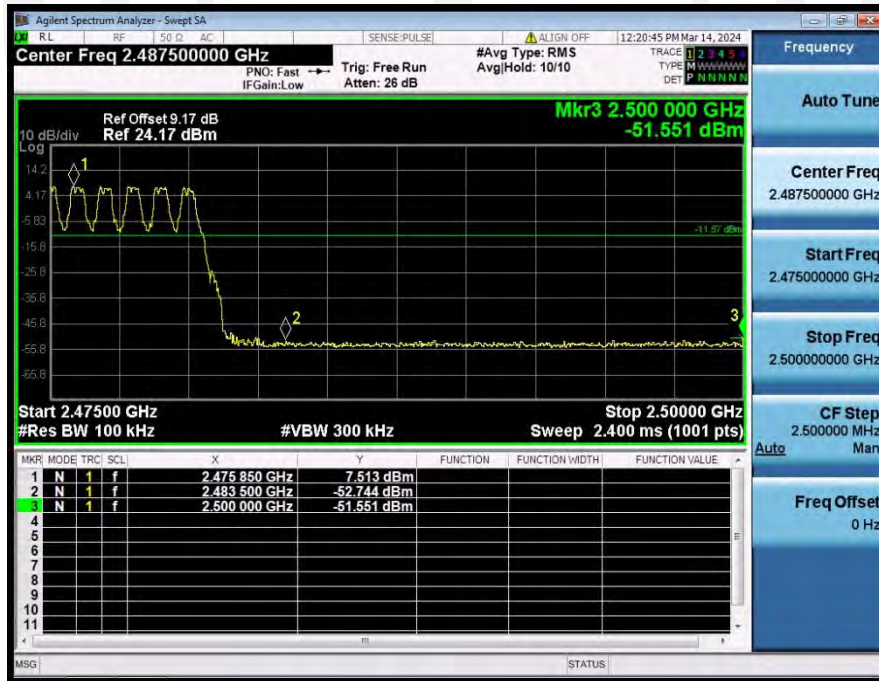

1_Reference_Level_NVNT_ANT1_2-DH1_2402

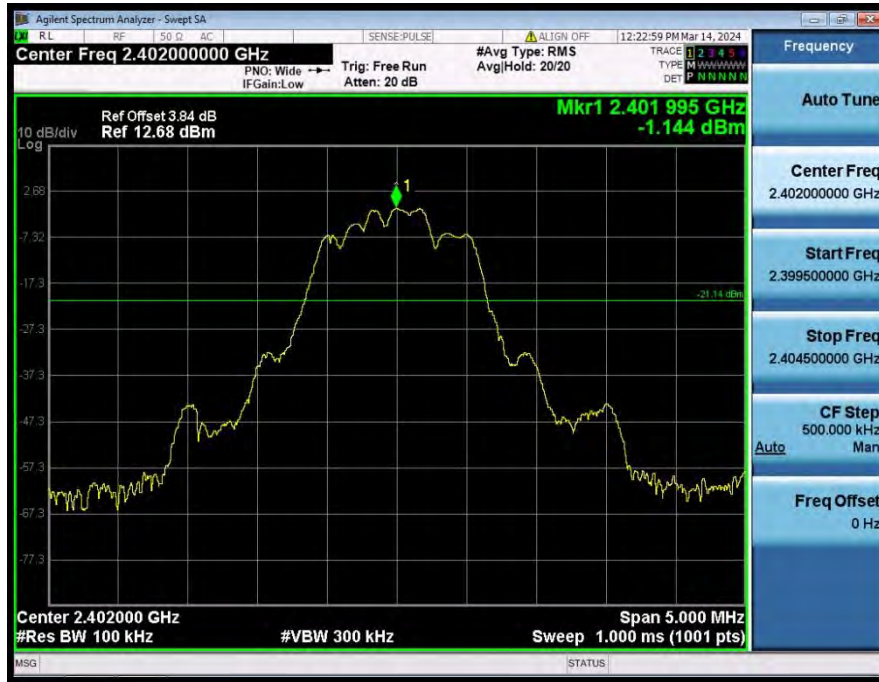

2_Bandedge_NVNT_ANT1_2-DH1_2402

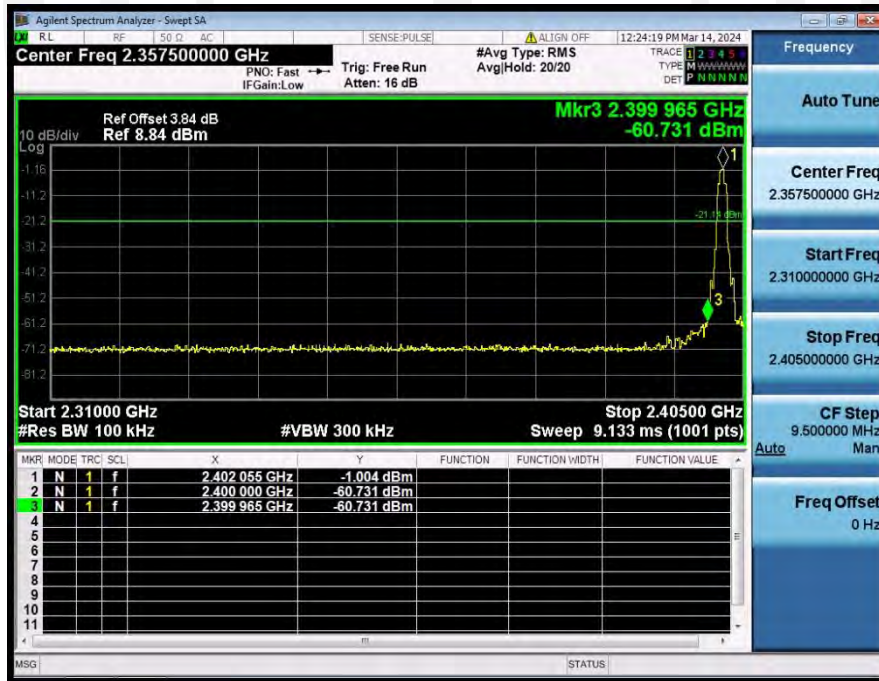

1_Reference_Level_Hopping_NVNT_ANT1_2-DH1_Hopping



2_Band_Edge_(Hopping)_NVNT_ANT1_2-DH1_Hopping

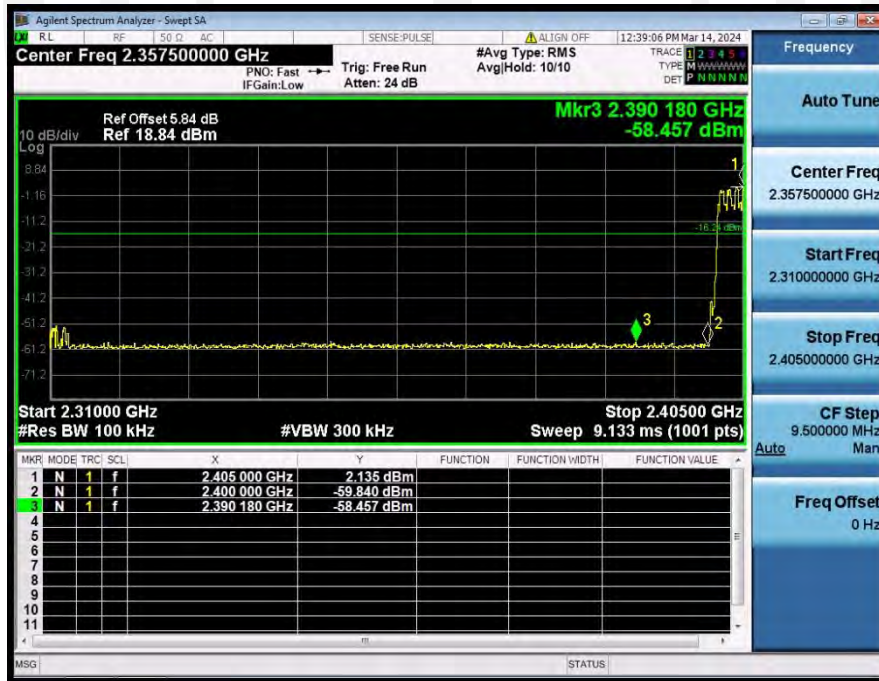

1_Reference_Level_NVNT_ANT1_2-DH1_2480



2_Bandedge_NVNT_ANT1_2-DH1_2480



1_Reference_Level_Hopping_NVNT_ANT1_2-DH1_Hopping



2_Band_Edge_(Hopping)_NVNT_ANT1_2-DH1_Hopping



Conducted spurious emission: Pass

1_Reference_Level_NVNT_ANT1_1-DH1_2402

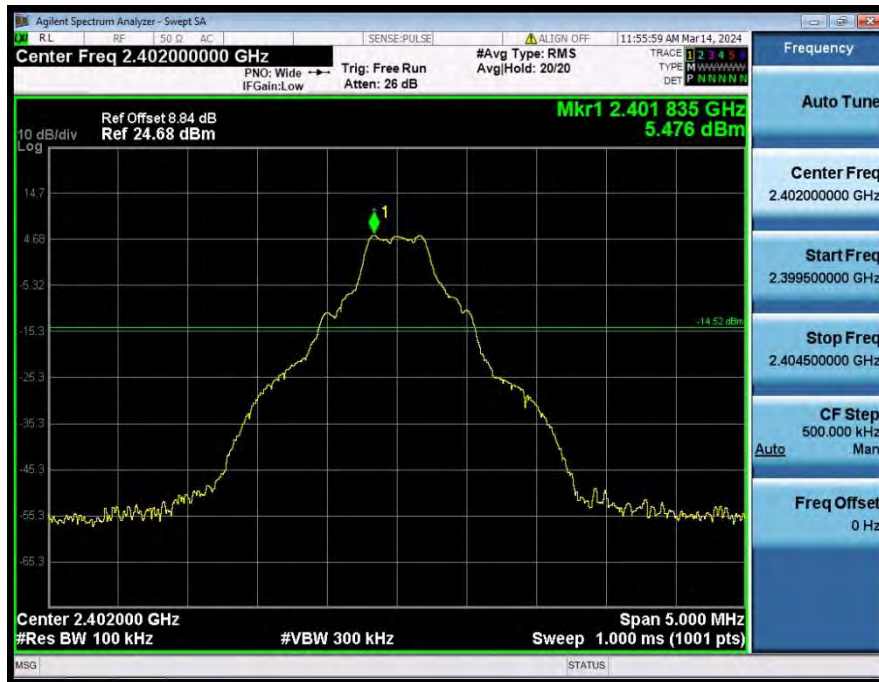

2_Spurious_Emissions_NVNT_ANT1_1-DH1_2402

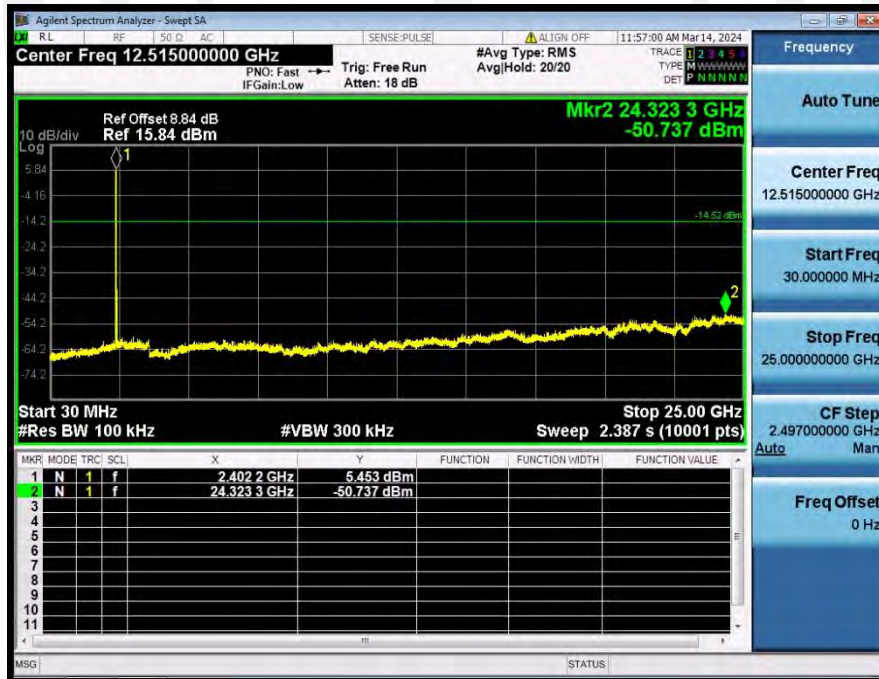

1_Reference_Level_NVNT_ANT1_1-DH1_2441



2_Spurious_Emissions_NVNT_ANT1_1-DH1_2441

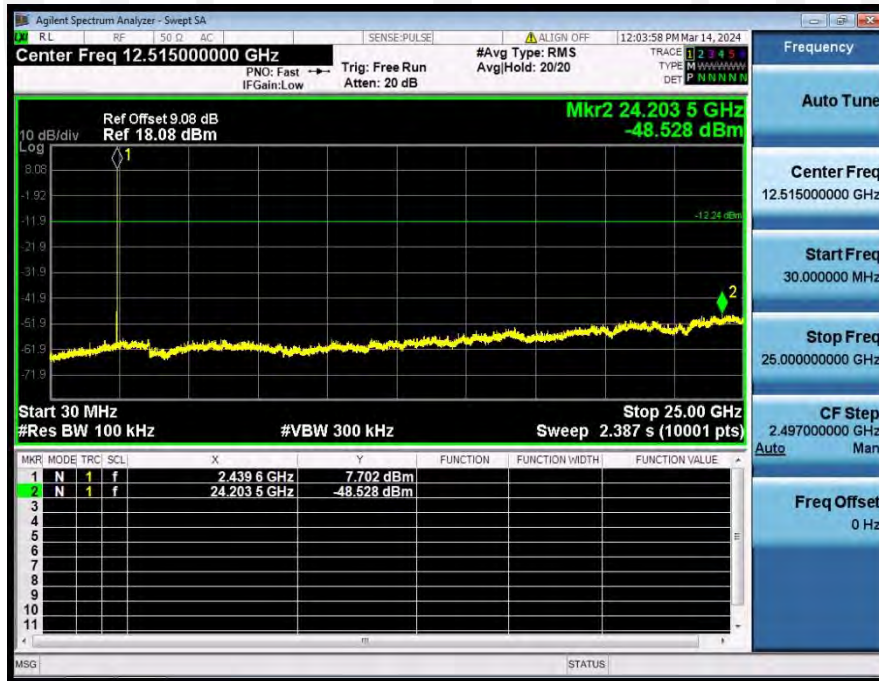

1_Reference_Level_NVNT_ANT1_1-DH1_2480



2_Spurious_Emissions_NVNT_ANT1_1-DH1_2480

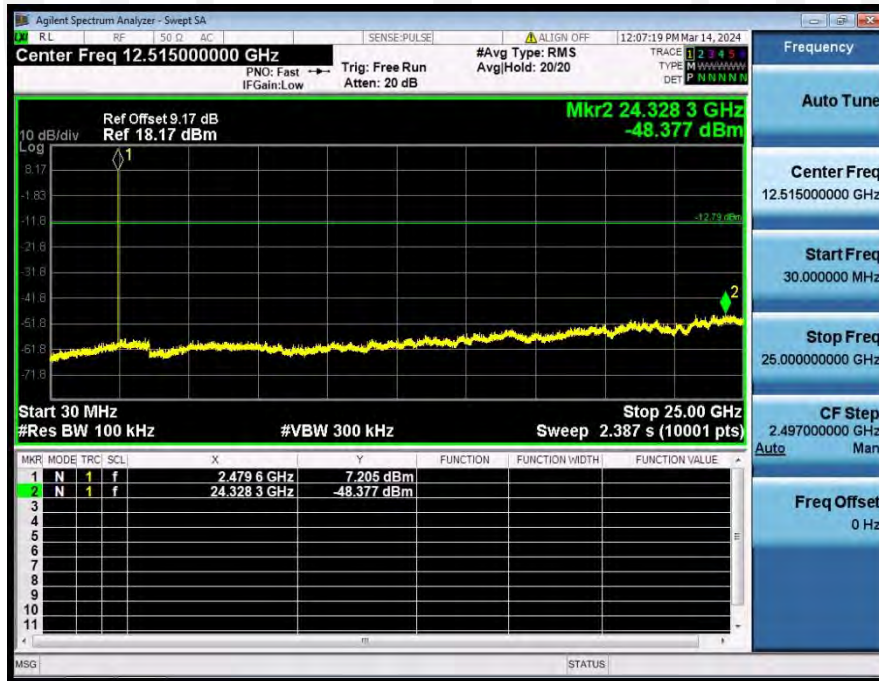

1_Reference_Level_NVNT_ANT1_2-DH1_2402

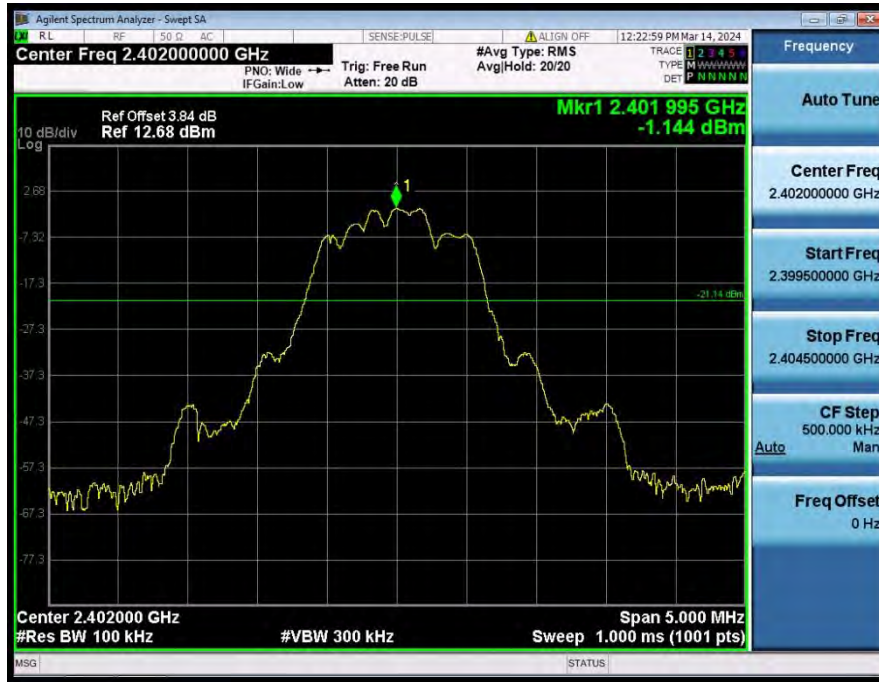

2_Spurious_Emissions_NVNT_ANT1_2-DH1_2402

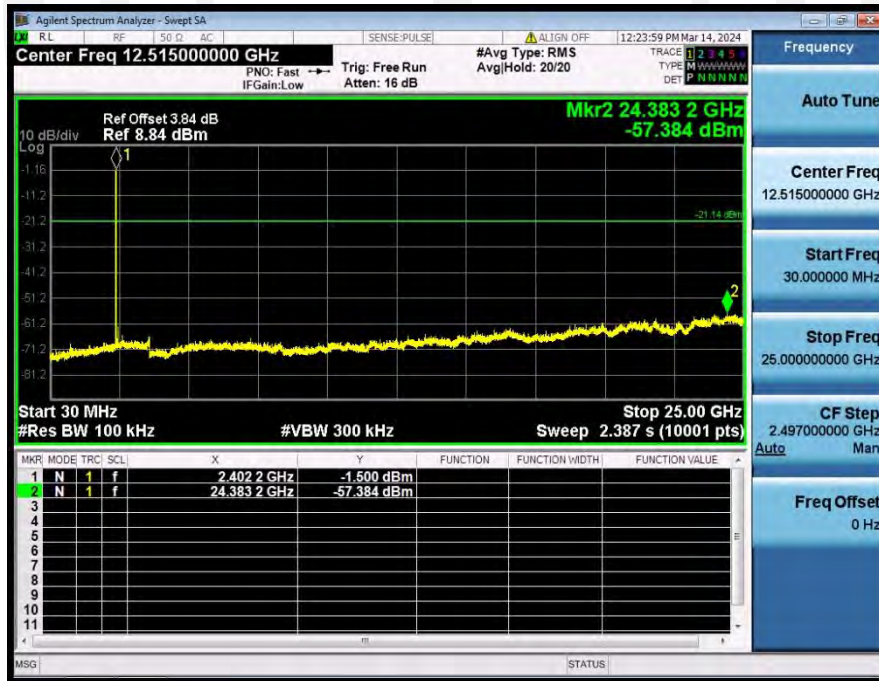

1_Reference_Level_NVNT_ANT1_2-DH1_2441



2_Spurious_Emissions_NVNT_ANT1_2-DH1_2441

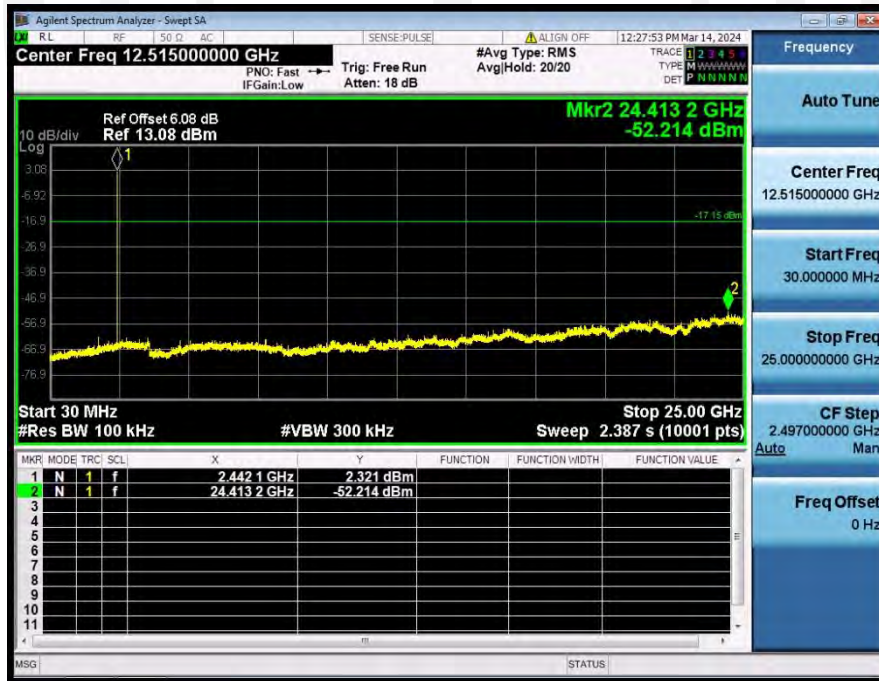

1_Reference_Level_NVNT_ANT1_2-DH1_2480



2_Spurious_Emissions_NVNT_ANT1_2-DH1_2480

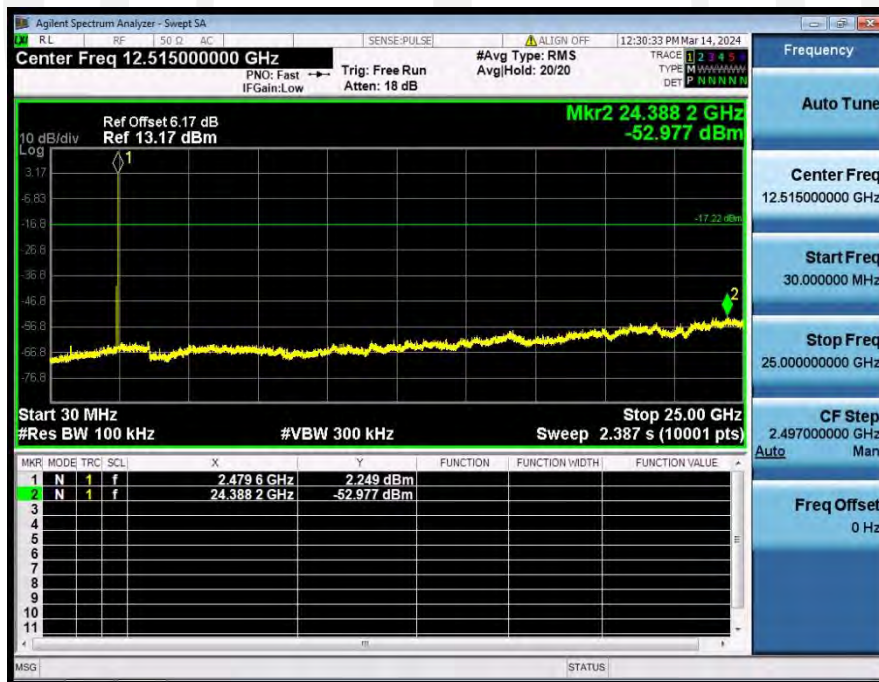

9. Radiated Emissions

9.1. Limit

All the emissions appearing within 15.205 restricted frequency bands shall not exceed the limits shown in 15.209, all the other emissions shall be at least 20dB below the fundamental emissions, or comply with 15.209 limits.

15.205 Restricted frequency band

MHz	MHz	MHz	GHz
0.090 - 0.110	16.42 - 16.423	399.9 - 410	4.5 - 5.15
¹ 0.495 - 0.505	16.69475 - 16.69525	608 - 614	5.35 - 5.46
2.1735 - 2.1905	16.80425 - 16.80475	960 - 1240	7.25 - 7.75
4.125 - 4.128	25.5 - 25.67	1300 - 1427	8.025 - 8.5
4.17725 - 4.17775	37.5 - 38.25	1435 - 1626.5	9.0 - 9.2
4.20725 - 4.20775	73 - 74.6	1645.5 - 1646.5	9.3 - 9.5
6.215 - 6.218	74.8 - 75.2	1660 - 1710	10.6 - 12.7
6.26775 - 6.26825	108 - 121.94	1718.8 - 1722.2	13.25 - 13.4
6.31175 - 6.31225	123 - 138	2200 - 2300	14.47 - 14.5
8.291 - 8.294	149.9 - 150.05	2310 - 2390	15.35 - 16.2
8.362 - 8.366	156.52475 - 156.52525	2483.5 - 2500	17.7 - 21.4
8.37625 - 8.38675	156.7 - 156.9	2690 - 2900	22.01 - 23.12
8.41425 - 8.41475	162.0125 - 167.17	3260 - 3267	23.6 - 24.0
12.29 - 12.293	167.72 - 173.2	3332 - 3339	31.2 - 31.8
12.51975 - 12.52025	240 - 285	3345.8 - 3358	36.43 - 36.5
12.57675 - 12.57725	322 - 335.4	3600 - 4400	(²)

15.209 Limit

FREQUENCY MHz	DISTANCE Meters	FIELD STRENGTHS LIMIT	
		$\mu\text{V}/\text{m}$	$\text{dB}(\mu\text{V})/\text{m}$
0.009-0.490	300	2400/F(KHz)	/
0.490-1.705	30	24000/F(KHz)	/
1.705-30	30	30	29.5
30 ~ 88	3	100	40.0
88 ~ 216	3	150	43.5
216 ~ 960	3	200	46.0
960 ~ 1000	3	500	54.0
Above 1000	3	74.0 dB(μV)/m (Peak) 54.0 dB(μV)/m (Average)	

Note: The peak limit is 20 dB higher than the average limit

9.2. Block Diagram of Test setup

8.2.1 In 3m Anechoic Chamber Test Setup Diagram for below 30MHz

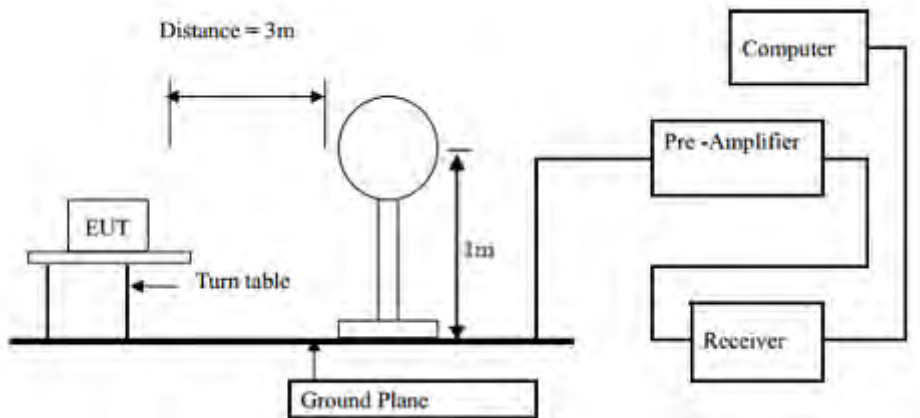

8.2.1 In 3m Anechoic Chamber Test Setup Diagram for below 1GHz

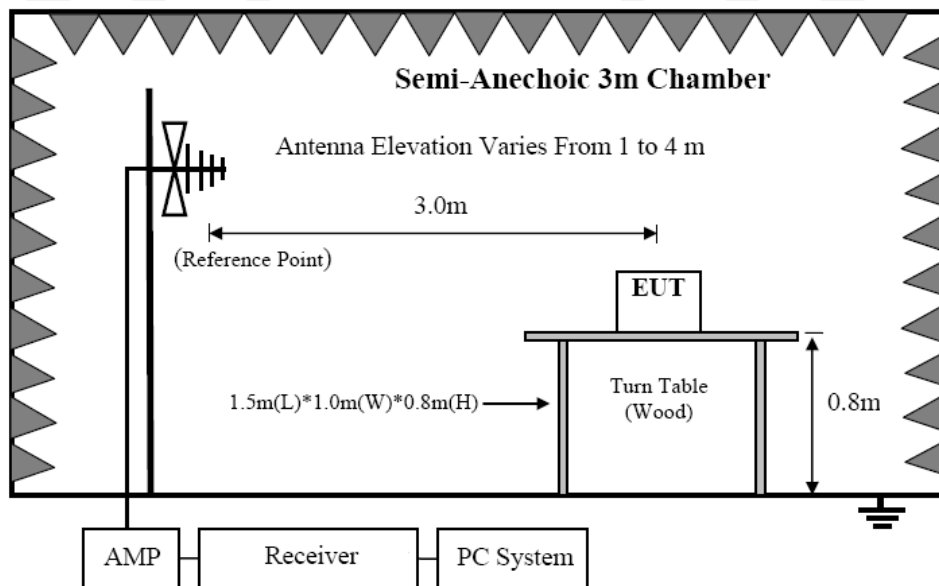

8.2.2 In 3m Anechoic Chamber Test Setup Diagram for frequency above 1GHz

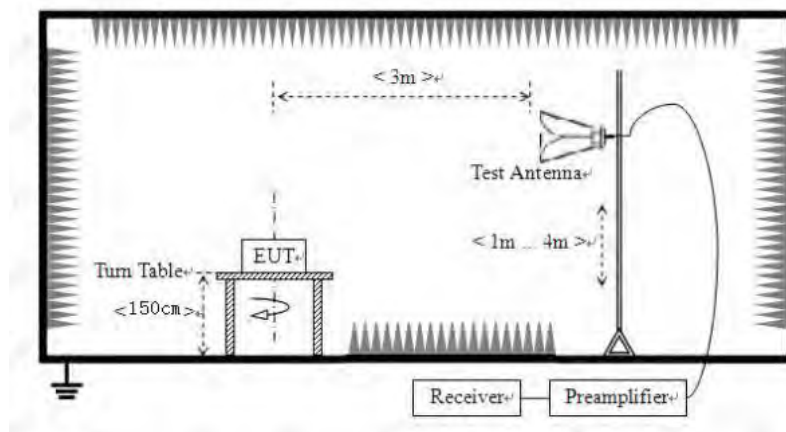

Note: For harmonic emissions test a appropriate high pass filter was inserted in the input port of AMP.

9.3. Test Procedure

- (1) EUT was placed on a non-metallic table, 80 cm above the ground plane inside a semi-anechoic chamber.
- (2) Setup EUT and simulator
- (3) Test antenna was located 3m from the EUT on an adjustable mast. Below pre-scan procedure was first performed in order to find prominent radiated emissions.
 - (a) Change work frequency or channel of device if practicable.
 - (b) Change modulation type of device if practicable.
 - (c) Rotated EUT though three orthogonal axes to determine the attitude of EUT arrangement produces highest emissions
- (4) Spectrum frequency from 9KHz to 25GHz (tenth harmonic of fundamental frequency) was investigated
- (5) For final emissions measurements at each frequency of interest, the EUT were rotated and the antenna height was varied between 1m and 4m in order to maximize the emission. Measurements in both horizontal and vertical polarities were made and the data was recorded. In order to find the maximum emission, the relative positions of equipments and all of the interface cables were changed according to ANSI C63.10 :2013on Radiated Emission test.
- (6) For emissions above 1GHz, both Peak and Average level were measured with Spectrum Analyzer, and the RBW is set at 1MHz, VBW is set at 3MHz for Peak measure; RBW is set at 1MHz, VBW is set at 10Hz for Average measure.

9.4. Test Results

We have scanned from 9kHz to the 10th harmonic of the EUT's highest frequency.

Detailed information please see the following page.

From 9KHz to 30MHz:	
Test Date : 2024.04.15	Temperature : 26°C
Test Engineer : Felix Pang	Humidity : 54%
Test Mode : GFSK mode	
Test Results : PASS	
Note:	The amplitude of spurious emissions which are attenuated by more than 20dB below the permissible value has no need to be reported.

From 30MHz to 1000MHz:	
Test Date : 2024.04.15	Temperature : 26°C
Test Engineer : Felix Pang	Humidity : 54%
Test Mode : GFSK mode	
Test Results : PASS	
Note:	<ol style="list-style-type: none">1. The test results are listed in next pages.2. If the limits for the measurement with the average detector are met when using a receiver with a peak detector, the test unit shall be deemed to meet both limits and the measurement with the average detector and quasi-peak detector need not be carried out.3. All modes have been tested, and only worst data of GFSK mode, Channel 2402MHz (AC 120V/ 60Hz) was listed in this report.



Polarization: Vertical

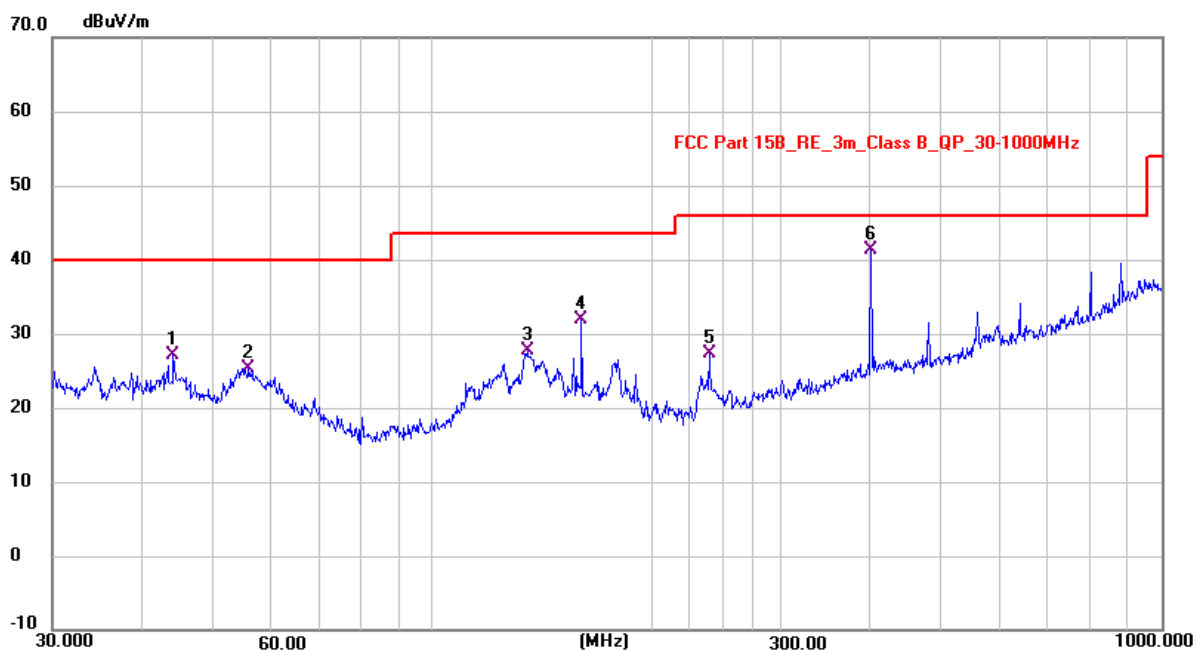

No.	Frequency (MHz)	Reading (dBuV)	Factor (dB/m)	Level (dBuV/m)	Limit (dBuV/m)	Margin (dB)	Detector
1	44.1009	13.56	13.46	27.02	40.00	-12.98	QP
2	55.8047	12.72	12.59	25.31	40.00	-14.69	QP
3	134.7953	15.18	12.47	27.65	43.50	-15.85	QP
4	159.9947	18.73	13.26	31.99	43.50	-11.51	QP
5	239.9873	15.37	11.98	27.35	46.00	-18.65	QP
6 *	400.0810	25.05	16.19	41.24	46.00	-4.76	QP

Note: Level = Reading + Factor Margin = Level - Limit

Polarization: Horizontal

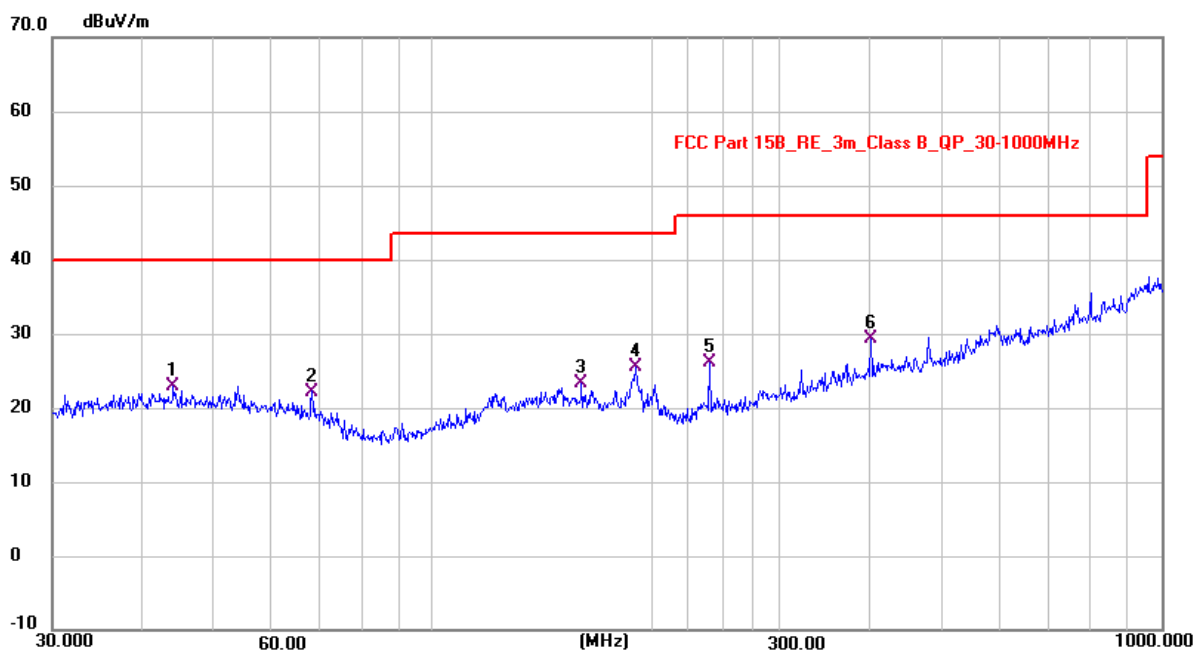

No.	Frequency (MHz)	Reading (dBuV)	Factor (dB/m)	Level (dBuV/m)	Limit (dBuV/m)	Margin (dB)	Detector
1	44.0237	9.44	13.47	22.91	40.00	-17.09	QP
2	68.3309	10.93	11.27	22.20	40.00	-17.80	QP
3	159.9947	10.12	13.26	23.38	43.50	-20.12	QP
4	190.2382	14.78	10.63	25.41	43.50	-18.09	QP
5	239.9873	14.19	11.98	26.17	46.00	-19.83	QP
6 *	400.0810	13.05	16.19	29.24	46.00	-16.76	QP

Note: Level = Reading + Factor Margin = Level - Limit

From 1GHz to 25GHz:	
Test Date : 2024.04.15	Temperature : 26°C
Test Engineer : Felix Pang	Humidity : 54%
Test Mode : GFSK, $\pi/4$ DQPSK mode	
Test Results : PASS	
Note:	<ol style="list-style-type: none">1. The test results are listed in next pages.2. If the limits for the measurement with the average detector are met when using a receiver with a peak detector, the test unit shall be deemed to meet both limits and the measurement with the average detector and quasi-peak detector need not be carried out.3. If the limits for the measurement with the average detector are met when using a receiver with a quasi-peak detector, the test unit shall be deemed to meet both limits and the measurement with the average detector need not be carried out.



Test Mode : GFSK TX Low								
No.	Freq MHz	Polarity	Reading (dBuV/m)	Correct Factor	Result (dBuV/m)	Limit (dBuV/m)	Margin	Remark
1	4804	V	84.62	-27.27	57.35	74.00	-16.65	Peak
2	4804	V	64.44	-27.27	37.17	54.00	-16.83	Avg
3	7206	--	--	--	--	--	--	--
4	9608	--	--	--	--	--	--	--
5	4804	H	82.66	-27.27	55.39	74.00	-18.61	Peak
6	4804	H	71.49	-27.27	44.22	54.00	-9.78	Avg
7	7206	--	--	--	--	--	--	--
8	9608	--	--	--	--	--	--	--
Test Mode : GFSK TX Mid								
1	4882	V	84.57	-27.79	56.78	74.00	-17.22	Peak
2	4882	V	67.00	-27.79	39.21	54.00	-14.79	Avg
3	7323	--	--	--	--	--	--	--
4	9764	--	--	--	--	--	--	--
5	4882	H	81.28	-27.79	53.49	74.00	-20.51	Peak
6	4882	H	70.45	-27.79	42.66	54.00	-11.34	Avg
7	7323	--	--	--	--	--	--	--
8	9764	--	--	--	--	--	--	--
Test Mode : GFSK TX High								
1	4960	V	86.49	-28.30	58.19	74.00	-15.81	Peak
2	4960	V	69.73	-28.30	41.43	54.00	-12.57	Avg
3	7440	--	--	--	--	--	--	--
4	9920	--	--	--	--	--	--	--
5	4960	H	82.10	-28.30	53.80	74.00	-20.20	Peak
6	4960	H	70.93	-28.30	42.63	54.00	-11.37	Avg
7	7440	--	--	--	--	--	--	--
8	9920	--	--	--	--	--	--	--
Note:	<p>1. Means other frequency and mode comply with standard requirements and at least have 20dB margin.</p> <p>2. Correct Factor=Cable Loss+ Antenna Factor-Amplifier Gain.</p> <p>Result=Reading + Correct Factor.</p> <p>Margin= Result-Limit.</p>							

Test Mode : $\pi/4$ DQPSK TX Low								
No.	Freq MHz	Polarity	Reading (dBuV/m)	Correct Factor	Result (dBuV/m)	Limit (dBuV/m)	Margin	Remark
1	4804	V	c	-27.27	55.39	74.00	-18.61	Peak
2	4804	V	66.16	-27.27	38.89	54.00	-15.11	Avg
3	7206	--	--	--	--	--	--	--
4	9608	--	--	--	--	--	--	--
5	4804	H	80.02	-27.27	52.75	74.00	-21.25	Peak
6	4804	H	72.26	-27.27	44.99	54.00	-9.01	Avg
7	7206	--	--	--	--	--	--	--
8	9608	--	--	--	--	--	--	--
Test Mode : $\pi/4$ DQPSK TX Mid								
1	4882	V	84.60	-27.79	56.81	74.00	-17.19	Peak
2	4882	V	63.90	-27.79	36.11	54.00	-17.89	Avg
3	7323	--	--	--	--	--	--	--
4	9764	--	--	--	--	--	--	--
5	4882	H	81.86	-27.79	54.07	74.00	-19.93	Peak
6	4882	H	70.81	-27.79	43.02	54.00	-10.98	Avg
7	7323	--	--	--	--	--	--	--
8	9764	--	--	--	--	--	--	--
Test Mode : $\pi/4$ DQPSK TX High								
1	4960	V	83.27	-28.30	54.97	74.00	-19.03	Peak
2	4960	V	70.35	-28.30	42.05	54.00	-11.95	Avg
3	7440	--	--	--	--	--	--	--
4	9920	--	--	--	--	--	--	--
5	4960	H	84.02	-28.30	55.72	74.00	-18.28	Peak
6	4960	H	70.90	-28.30	42.60	54.00	-11.40	Avg
7	7440	--	--	--	--	--	--	--
8	9920	--	--	--	--	--	--	--
Note:	1. Means other frequency and mode comply with standard requirements and at least have 20dB margin. 2. Correct Factor=Cable Loss+ Antenna Factor-Amplifier Gain. Result=Reading + Correct Factor. Margin= Result-Limit.							

10. Band Edge Test

10.1. Block Diagram of Test Setup

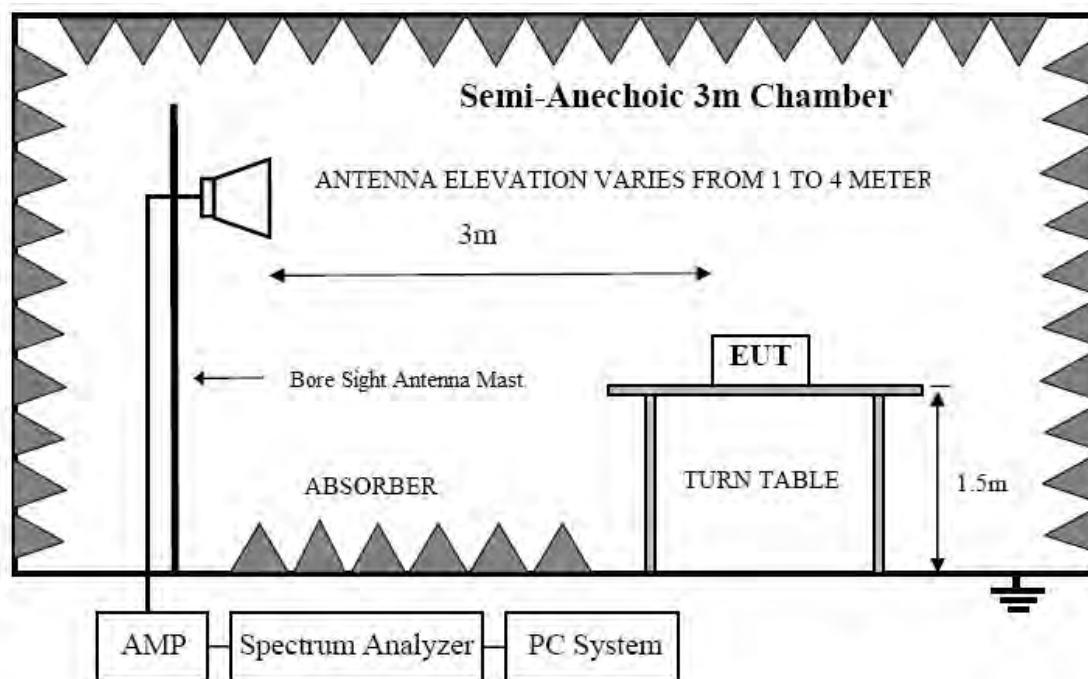

10.2. Test Limit

Radiated emissions which fall in the restricted bands, as defined in § 15.205(a), must also comply with the radiated emission limits specified in § 15.209(a) (see § 15.205(c)).

10.3. Test Procedure

Refer to ANSI C 63.10, Clause 6.10.

All restriction band and non-restriction band have been tested, only worse case is reported.

10.4. Test Results

Test Date	: 2024.04.15	Temperature	: 26°C
Test Engineer	: Felix Pang	Humidity	: 54%
Test Results	: PASS		

Frequency Range : 2310MHz~2410MHz								
Test Mode : GFSK TX 2402MHz								
No.	Freq MHz	Polarity	Reading (dBuV/m)	Correct Factor	Result (dBuV/m)	Limit (dBuV/m)	Margin	Remark
1	2390	H	72.65	-21.62	51.03	74.00	-22.97	Peak
2	2390	H	--	-21.62	--	54.00	--	Avg
3	2400	H	78.41	-26.08	52.33	74.00	-21.67	Peak
4	2400	H	--	-26.08	--	54.00	--	Avg
1	2390	V	69.73	-21.62	48.11	74.00	-25.89	Peak
2	2390	V	--	-21.62	--	54.00	--	Avg
3	2400	V	78.85	-26.08	52.77	74.00	-21.23	Peak
4	2400	V	--	-26.08	--	54.00	--	Avg
Frequency Range : 2450MHz~2550MHz								
Test Mode : GFSK TX 2480MHz								
1	2483.5	H	77.18	-25.84	51.34	74.00	-22.66	Peak
2	2483.5	H	--	-25.84	--	54.00	--	Avg
1	2483.5	V	74.59	-25.84	48.75	74.00	-25.25	Peak
2	2483.5	V	--	-25.84	--	54.00	--	Avg
Note:	<p>1. Means other frequency and mode comply with standard requirements and at least have 20dB margin.</p> <p>2. Correct Factor=Cable Loss+ Antenna Factor-Amplifier Gain. Result=Reading + Correct Factor. Margin= Result-Limit.</p> <p>5. If the limits for the measurement with the average detector are met when using a receiver with a peak detector, the test unit shall be deemed to meet both limits and the measurement with the average detector need not be carried out.</p>							

Frequency Range : 2310MHz~2410MHz								
Test Mode : $\pi/4$ DQPSK TX 2402MHz								
No.	Freq MHz	Polarity	Reading (dBuV/m)	Correct Factor	Result (dBuV/m)	Limit (dBuV/m)	Margin	Remark
1	2390	H	71.04	-21.62	49.42	74.00	-24.58	Peak
2	2390	H	--	-21.62	--	54.00	--	Avg
3	2400	H	78.31	-26.08	52.23	74.00	-21.77	Peak
4	2400	H	--	-26.08	--	54.00	--	Avg
1	2390	V	67.47	-21.62	45.85	74.00	-28.15	Peak
2	2390	V	--	-21.62	--	54.00	--	Avg
3	2400	V	75.83	-26.08	49.75	74.00	-24.25	Peak
4	2400	V	--	-26.08	--	54.00	--	Avg
Frequency Range : 2450MHz~2550MHz								
Test Mode : $\pi/4$ DQPSK TX 2480MHz								
1	2483.5	H	74.59	-25.84	48.75	74.00	-25.25	Peak
2	2483.5	H	--	-25.84	--	54.00	--	Avg
1	2483.5	V	73.73	-25.84	47.89	74.00	-26.11	Peak
2	2483.5	V	--	-25.84	--	54.00	--	Avg
Note:	<p>1. Means other frequency and mode comply with standard requirements and at least have 20dB margin.</p> <p>2. Correct Factor=Cable Loss+ Antenna Factor-Amplifier Gain. Result=Reading + Correct Factor. Margin= Result-Limit.</p> <p>3. If the limits for the measurement with the average detector are met when using a receiver with a peak detector, the test unit shall be deemed to meet both limits and the measurement with the average detector need not be carried out.</p>							

11. Power Line Conducted Emissions

11.1. Block Diagram of Test Setup

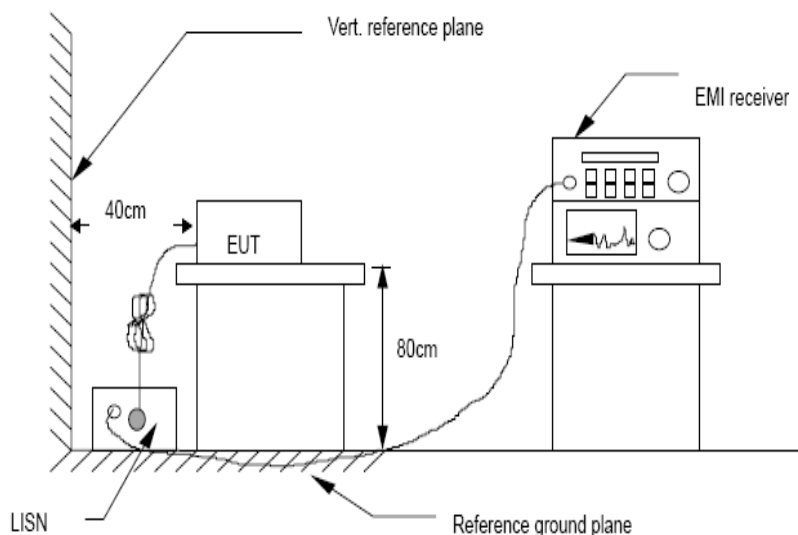

11.2. Limit

Frequency	Maximum RF Line Voltage	
	Quasi-Peak Level dB(μ V)	Average Level dB(μ V)
150kHz ~ 500kHz	66 ~ 56*	56 ~ 46*
500kHz ~ 5MHz	56	46
5MHz ~ 30MHz	60	50

Notes: 1. * Decreasing linearly with logarithm of frequency.

2. The lower limit shall apply at the transition frequencies.

11.3. Test Procedure

- (1) The EUT was placed on a non-metallic table, 80cm above the ground plane.
- (2) Setup the EUT and simulator as shown in 10.1
- (3) The EUT Power connected to the power mains through a power adapter and a line impedance stabilization network (L.I.S.N1). The other peripheral devices power cord connected to the power mains through a line impedance stabilization network (L.I.S.N2), this provided a 50-ohm coupling impedance for the EUT (Please refer to the block diagram of the test setup and photographs). Both sides of power line were checked for maximum conducted interference. In order to find the maximum emission, the relative positions of equipments and all of the interface cables were changed according to ANSI C63.10:2013on conducted Emission test.

- (4) The bandwidth of test receiver is set at 10KHz.
 (5) The frequency range from 150 KHz to 30MHz is checked.

11.4.Test Results

Test Date	: 2024.04.15	Temperature	: 26°C
Test Engineer	: Felix Pang	Humidity	: 54%
Test Mode	: GFSK mode		
Test Results	: PASS		
Note:	<ol style="list-style-type: none"> 1. The test results are listed in next pages. 2. If the limits for the measurement with the average detector are met when using a receiver with a peak detector, the test unit shall be deemed to meet both limits and the measurement with the average detector and quasi-peak detector need not be carried out. 3. If the limits for the measurement with the average detector are met when using a receiver with a quasi-peak detector, the test unit shall be deemed to meet both limits and the measurement with the average detector need not be carried out. 4. All modes have been tested, and only worst data of GFSK mode, Channel 2402MHz (AC 120V/ 60Hz) was listed in this report. 		

Polarization: L

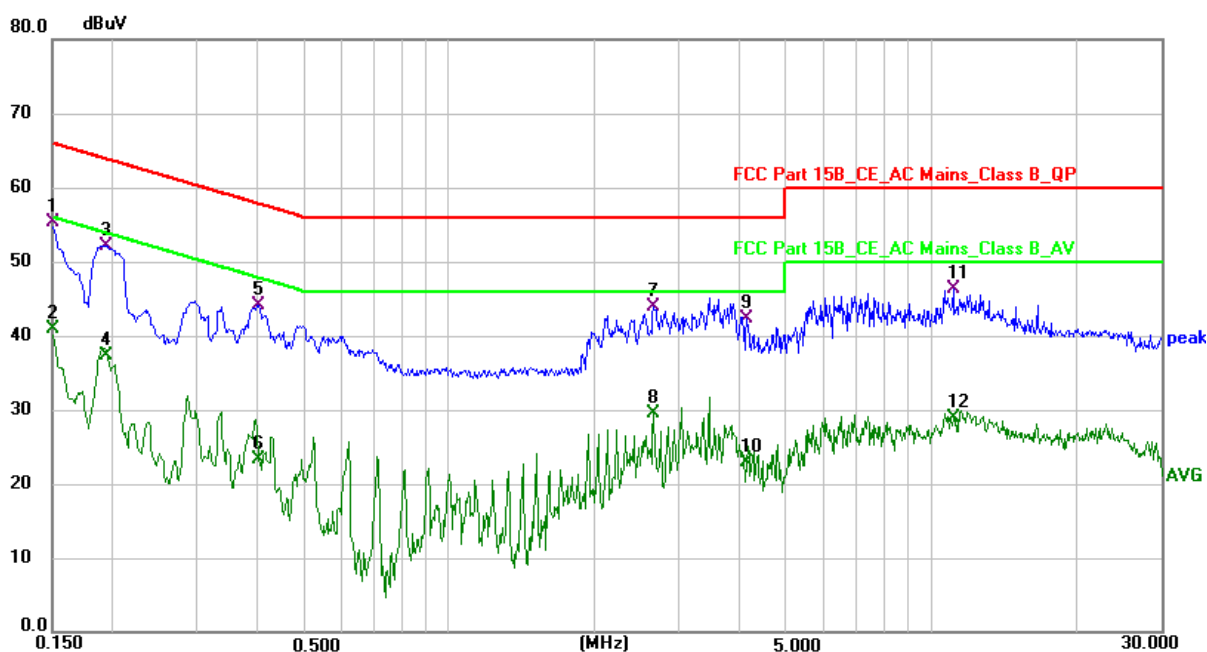

No.	Frequency (MHz)	Reading (dBuV)	Factor (dB)	Level (dBuV)	Limit (dBuV)	Margin (dB)	Detector	P/F
1 *	0.1500	45.28	9.94	55.22	66.00	-10.78	QP	P
2	0.1500	31.04	9.94	40.98	56.00	-15.02	AVG	P
3	0.1952	42.21	9.95	52.16	63.81	-11.65	QP	P
4	0.1952	27.26	9.95	37.21	53.81	-16.60	AVG	P
5	0.4020	34.46	9.63	44.09	57.81	-13.72	QP	P
6	0.4020	13.76	9.63	23.39	47.81	-24.42	AVG	P
7	2.6580	34.57	9.38	43.95	56.00	-12.05	QP	P
8	2.6580	20.04	9.38	29.42	46.00	-16.58	AVG	P
9	4.1540	32.91	9.40	42.31	56.00	-13.69	QP	P
10	4.1540	13.51	9.40	22.91	46.00	-23.09	AVG	P
11	11.0980	36.68	9.54	46.22	60.00	-13.78	QP	P
12	11.0980	19.44	9.54	28.98	50.00	-21.02	AVG	P

Note: Level = Reading + Factor Margin = Level - Limit

Polarization: N

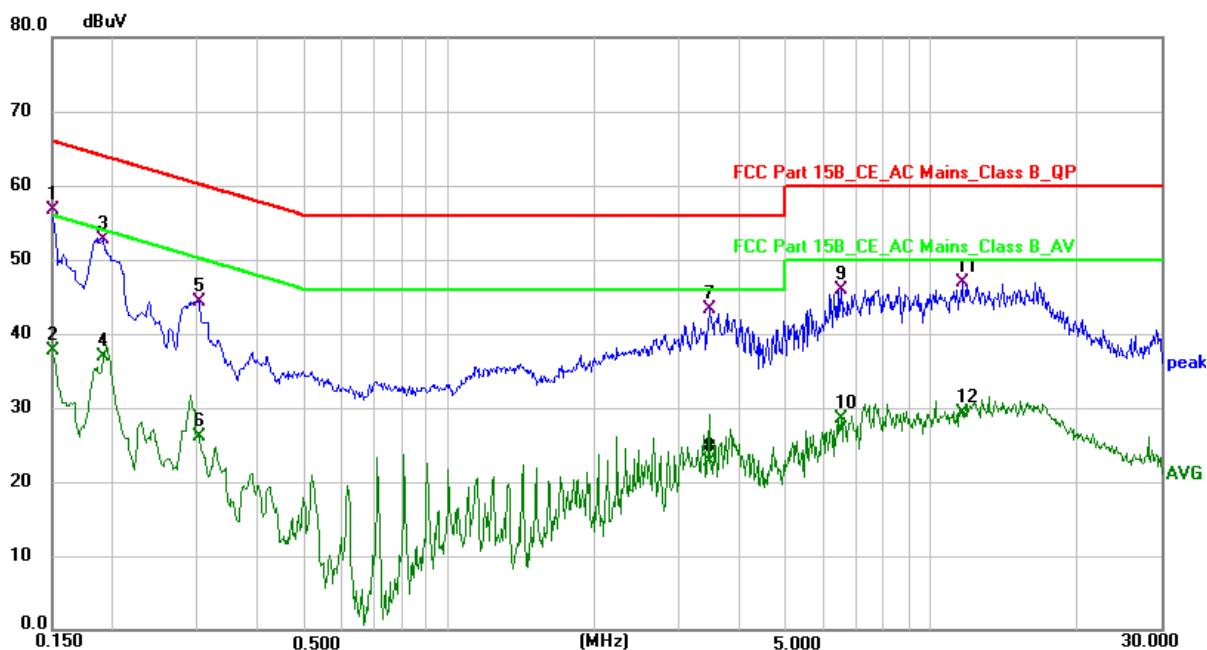

No.	Frequency (MHz)	Reading (dBuV)	Factor (dB)	Level (dBuV)	Limit (dBuV)	Margin (dB)	Detector	P/F
1 *	0.1500	46.92	9.77	56.69	66.00	-9.31	QP	P
2	0.1500	27.99	9.77	37.76	56.00	-18.24	AVG	P
3	0.1912	42.66	10.00	52.66	63.98	-11.32	QP	P
4	0.1912	26.86	10.00	36.86	53.98	-17.12	AVG	P
5	0.3020	34.50	9.77	44.27	60.19	-15.92	QP	P
6	0.3020	16.25	9.77	26.02	50.19	-24.17	AVG	P
7	3.4740	33.67	9.56	43.23	56.00	-12.77	QP	P
8	3.4740	13.20	9.56	22.76	46.00	-23.24	AVG	P
9	6.5060	36.49	9.51	46.00	60.00	-14.00	QP	P
10	6.5060	19.05	9.51	28.56	50.00	-21.44	AVG	P
11	11.5620	37.31	9.54	46.85	60.00	-13.15	QP	P
12	11.5620	19.81	9.54	29.35	50.00	-20.65	AVG	P

Note: Level = Reading + Factor Margin = Level - Limit

12. Antenna Requirements

12.1. Limit

For intentional device, according to FCC 47 CFR Section 15.203 and RSS-GEN, an intentional radiator shall be designed to ensure that no antenna other than that furnished by the responsible party shall be used with the device. And according to FCC 47 CFR Section 15.247 (b), if transmitting antennas of directional gain greater than 6dBi are used, the power shall be reduced by the amount in dB that the directional gain of the antenna exceeds 6dBi.

12.2. Result

The EUT antenna is internal antenna. It complies with the standard requirement.



13. Photos of test setup

Reference to the **appendix I Test Setup Photo** for details.

14. Photos of EUT

Reference to the **appendix II external photos** and **appendix III internal photos** for details.

----- END OF REPORT-----

