

# Antenna Specification

## Specifications

### Summary

ITEM	SPEC.	
Model Name	2.4 GHz	
Center Frequency	2402 MHz	1.77 dBi
	2441 MHz	2.00dBi
	2480 MHz	1.39 dBi
MAX. GAIN	2.00 dBi	
Polarization	Horizontal	
Azimuth Beam Pattern	Omni-directional	
Impedance	50 $\Omega$	
Antenna Length	10.5cm	

### Antenna Photo & Length (mm)

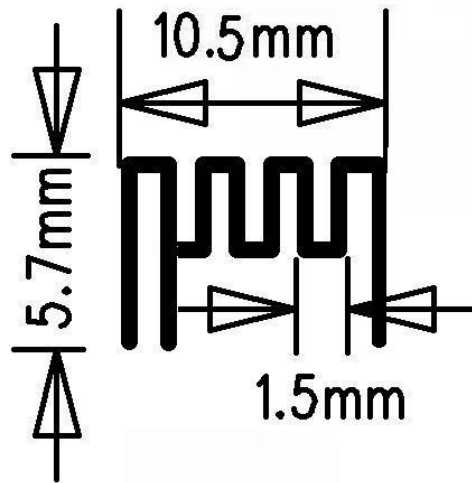

# 1. Main antenna : 2402 MHz

## 1.1 Horizontal

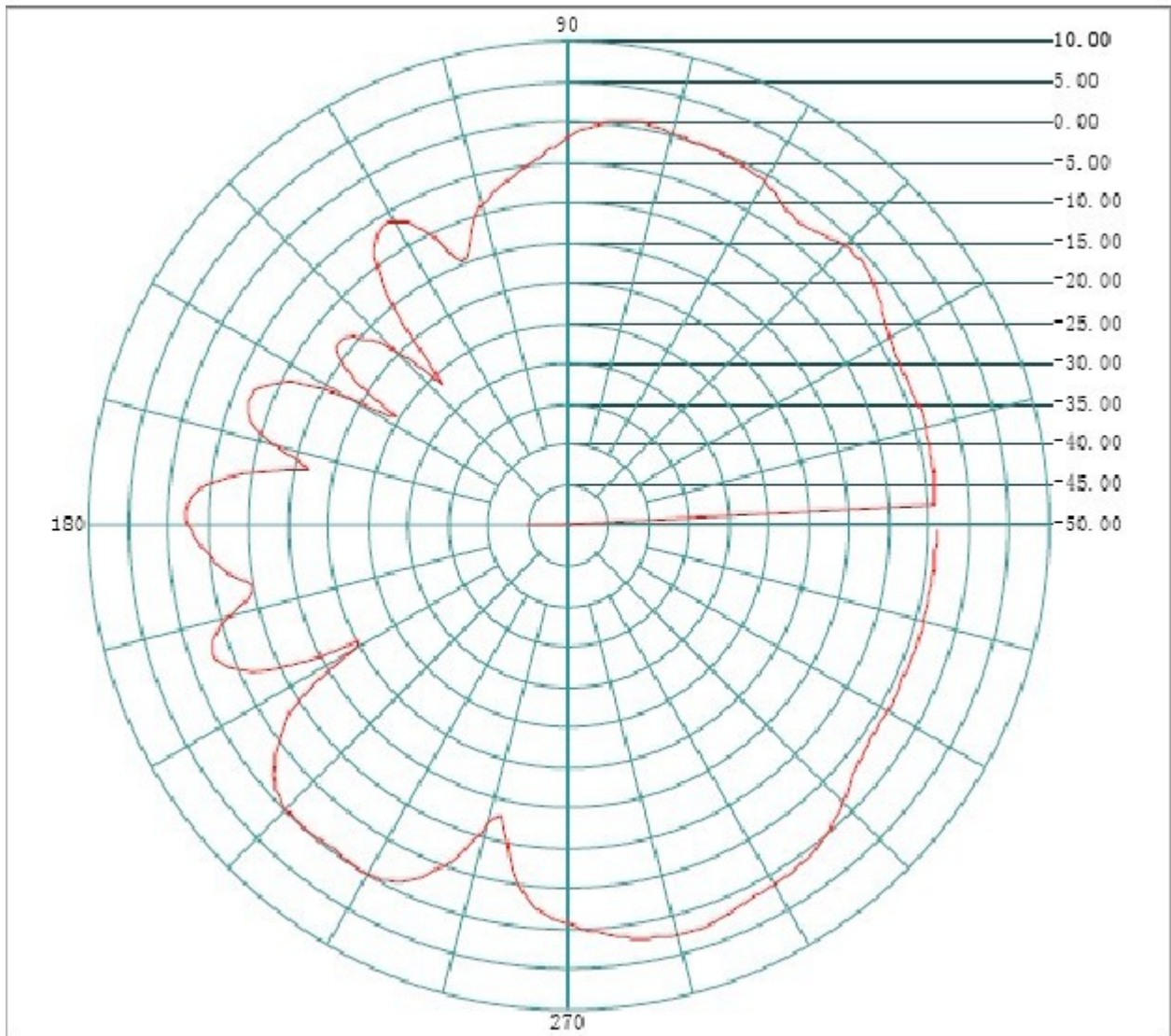

Frequency(MHZ): **2402**

Antenna Polarity: **Horizontal**

Maximum Gain(dBi): **1.77**

Average Gain(dBi) : **-2.81**

Minimum Gain(dBi): **-58.27**

**1.2 Vertical**

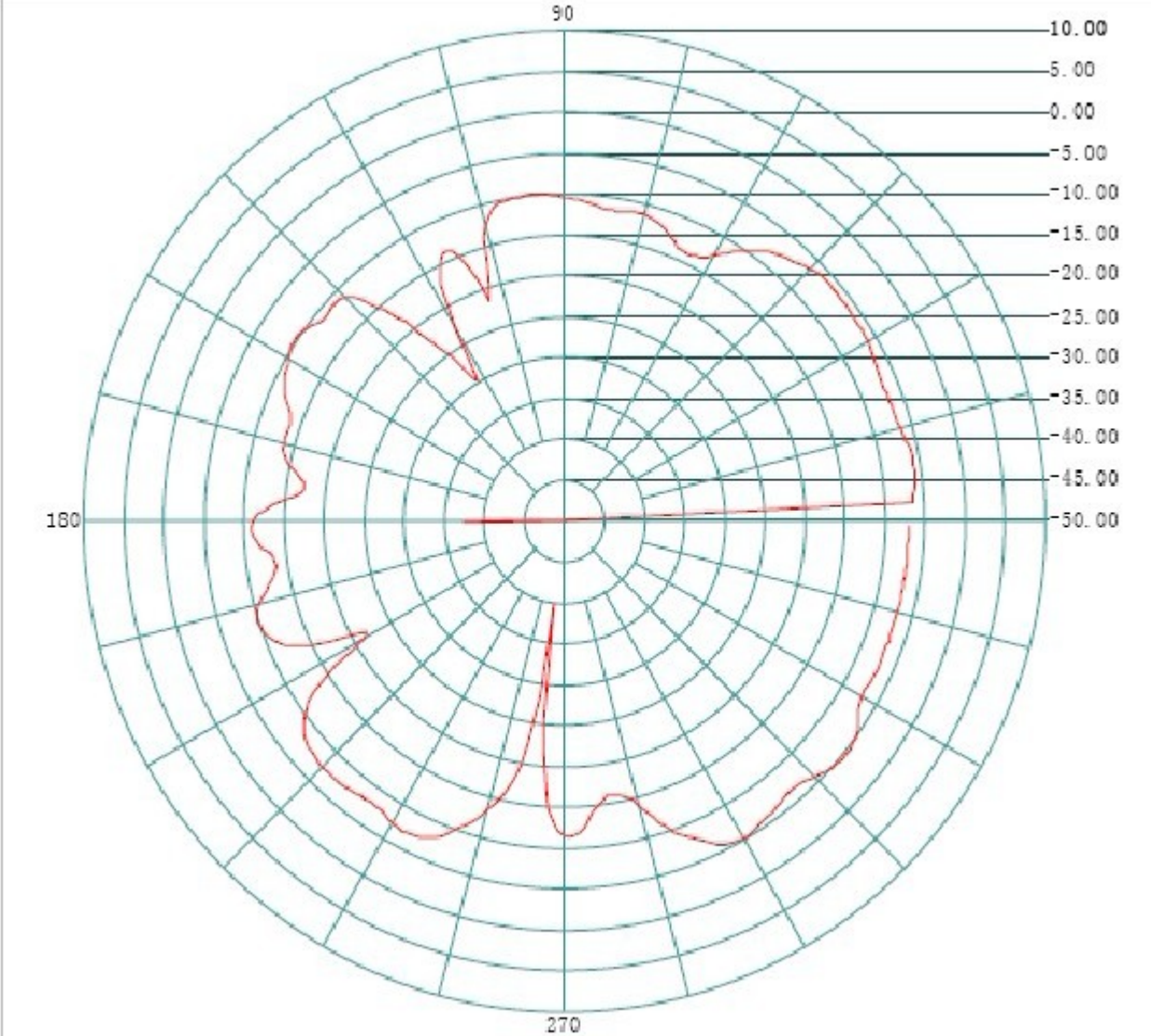

Frequency(MHZ): **2402**

Antenna Polarity: **Vertical**

Maximum Gain(dBi): **-5.19**

Average Gain(dBi) : **-9.47**

Minimum Gain(dBi): **-69.21**

## 2. Main antenna : 2441 MHz

### 2.1 Horizontal

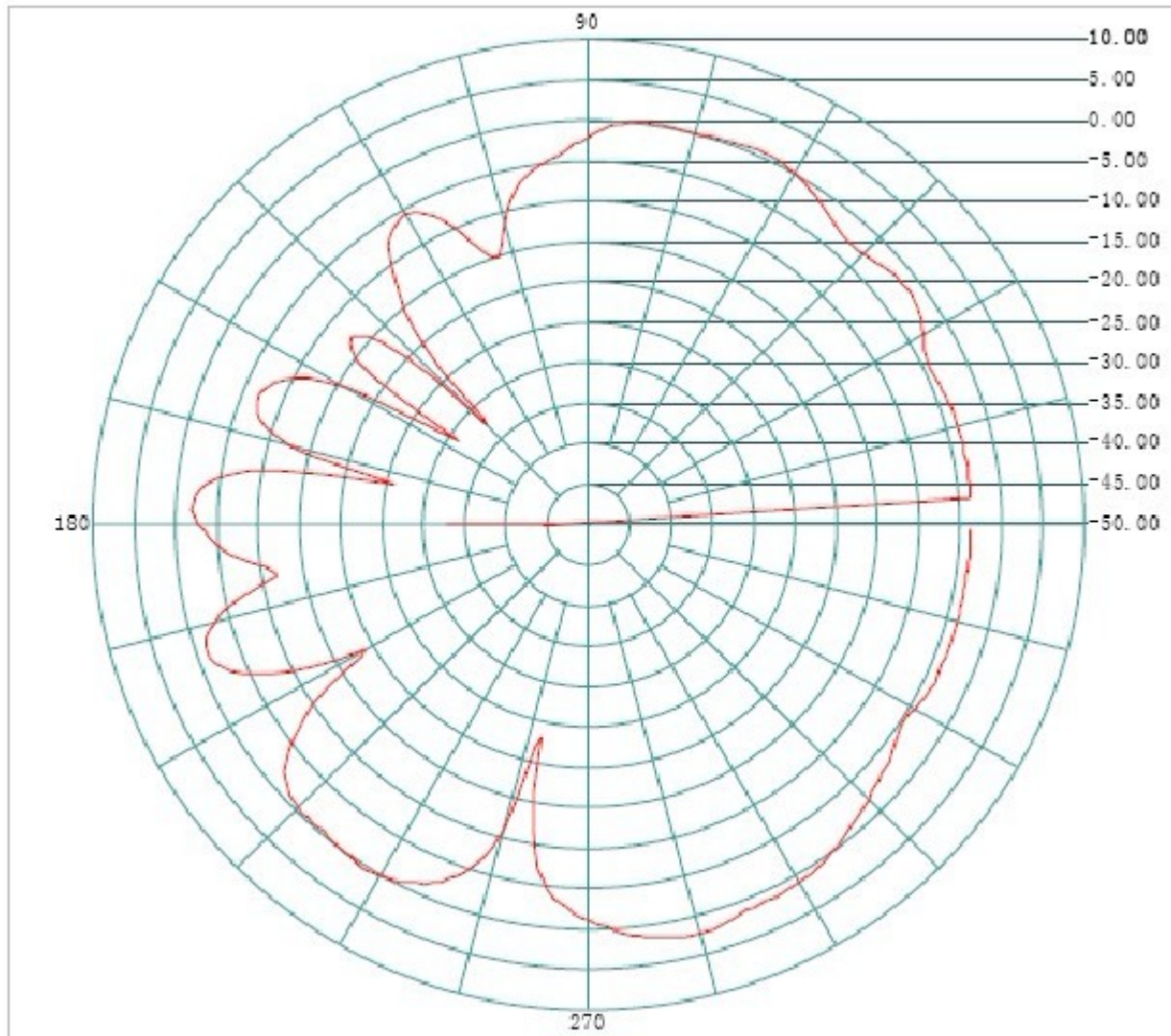

Frequency(MHZ): **2441**

Antenna Polarity: **Horizontal**

Maximum Gain(dBi): **'2.00**

Average Gain(dBi) : **-2.07**

Minimum Gain(dBi): **-61.53**

''

## 2.2 Vertical

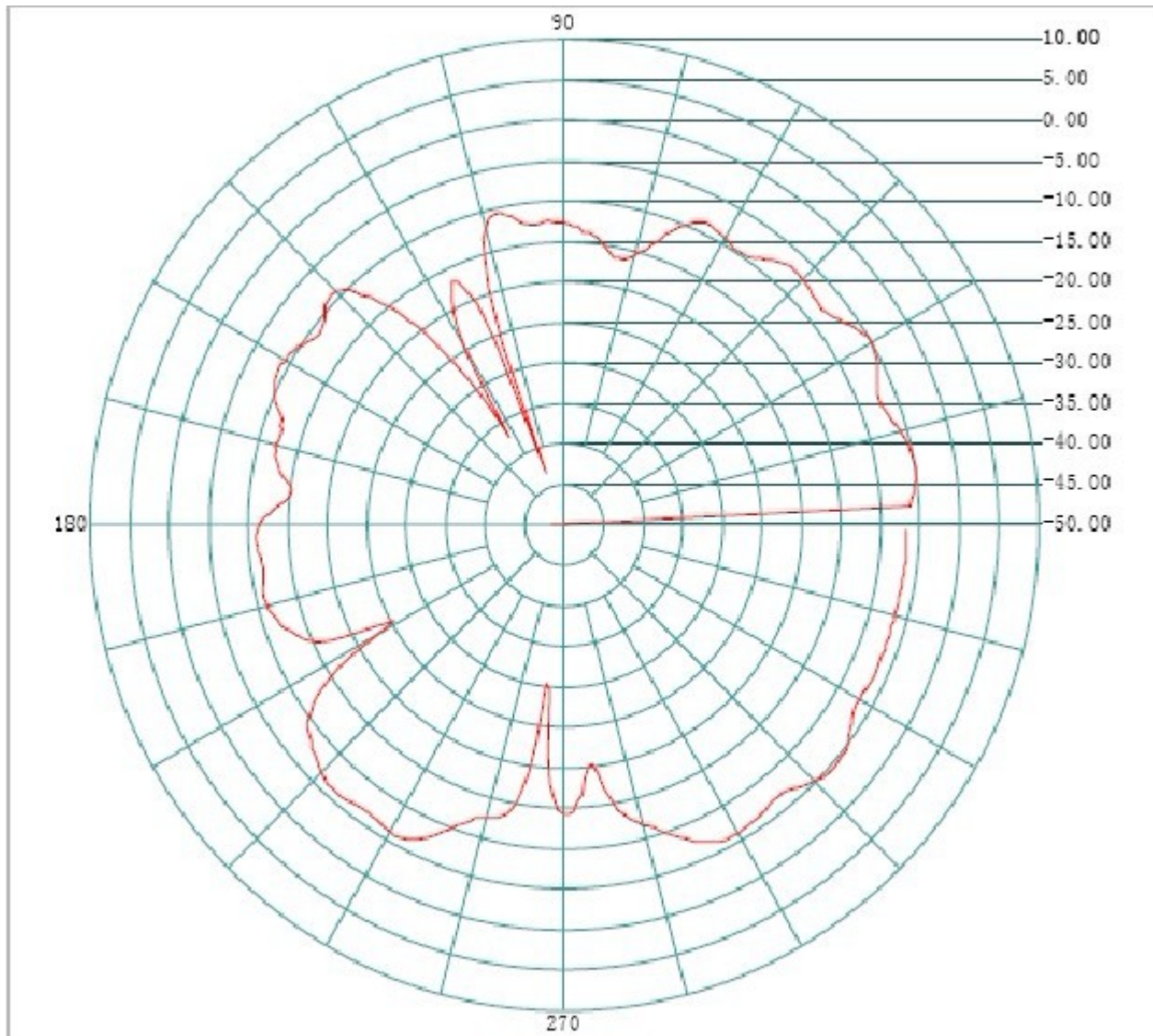

Frequency(MHZ): **2441**

Antenna Polarity: **Vertical**

Maximum Gain(dBi): **-3.99**

Average Gain(dBi) : **-8.06**

Minimum Gain(dBi): **-56.41**

## 2. Main antenna : 2480 MHz

### 2.1 Horizontal

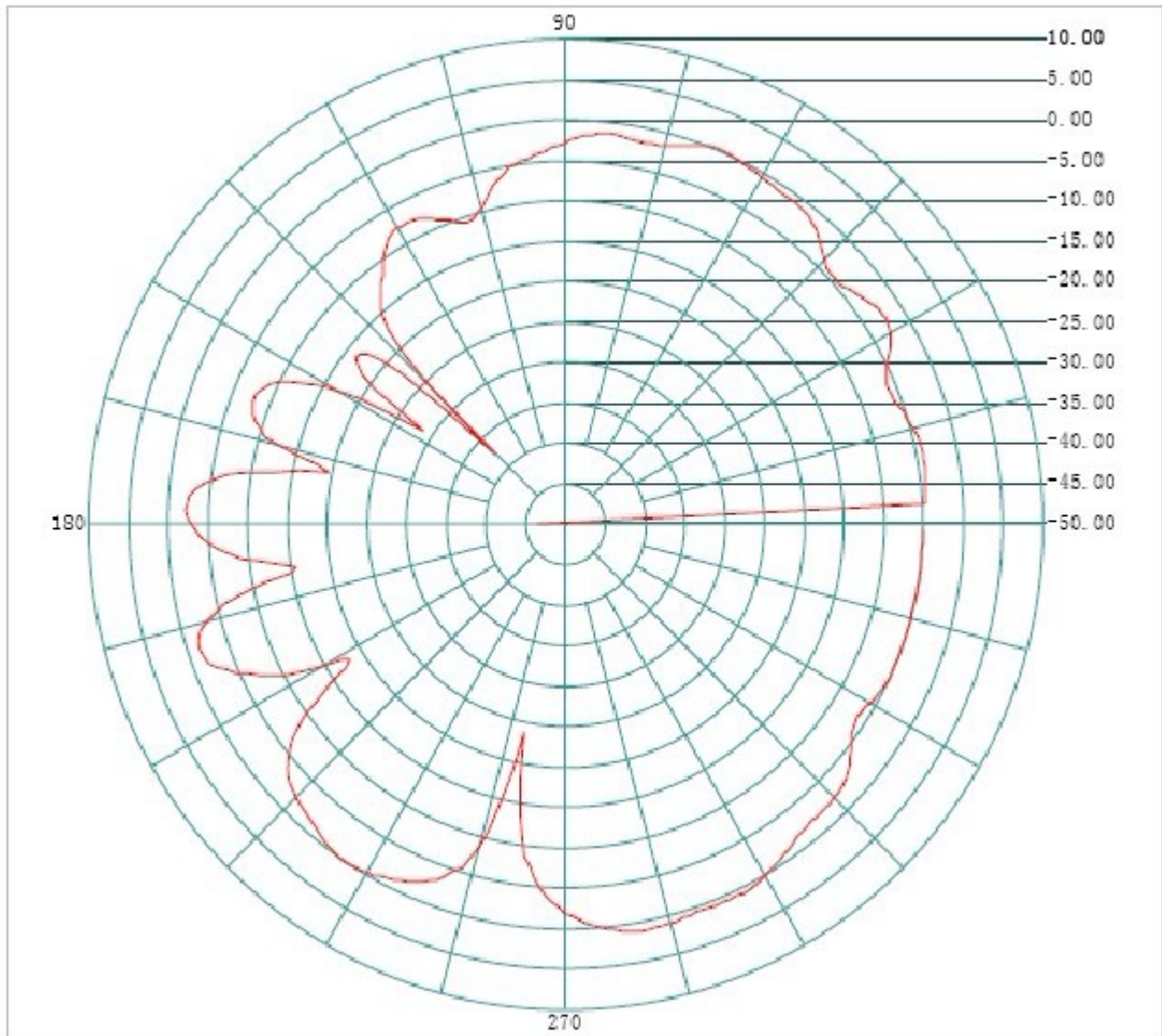

Frequency(MHZ): **2480**

Antenna Polarity: **Horizontal**

Maximum Gain(dBi): **1.39**

Average Gain(dBi) : **-3.29**

Minimum Gain(dBi): **-58.14**

## 2.2 Vertical

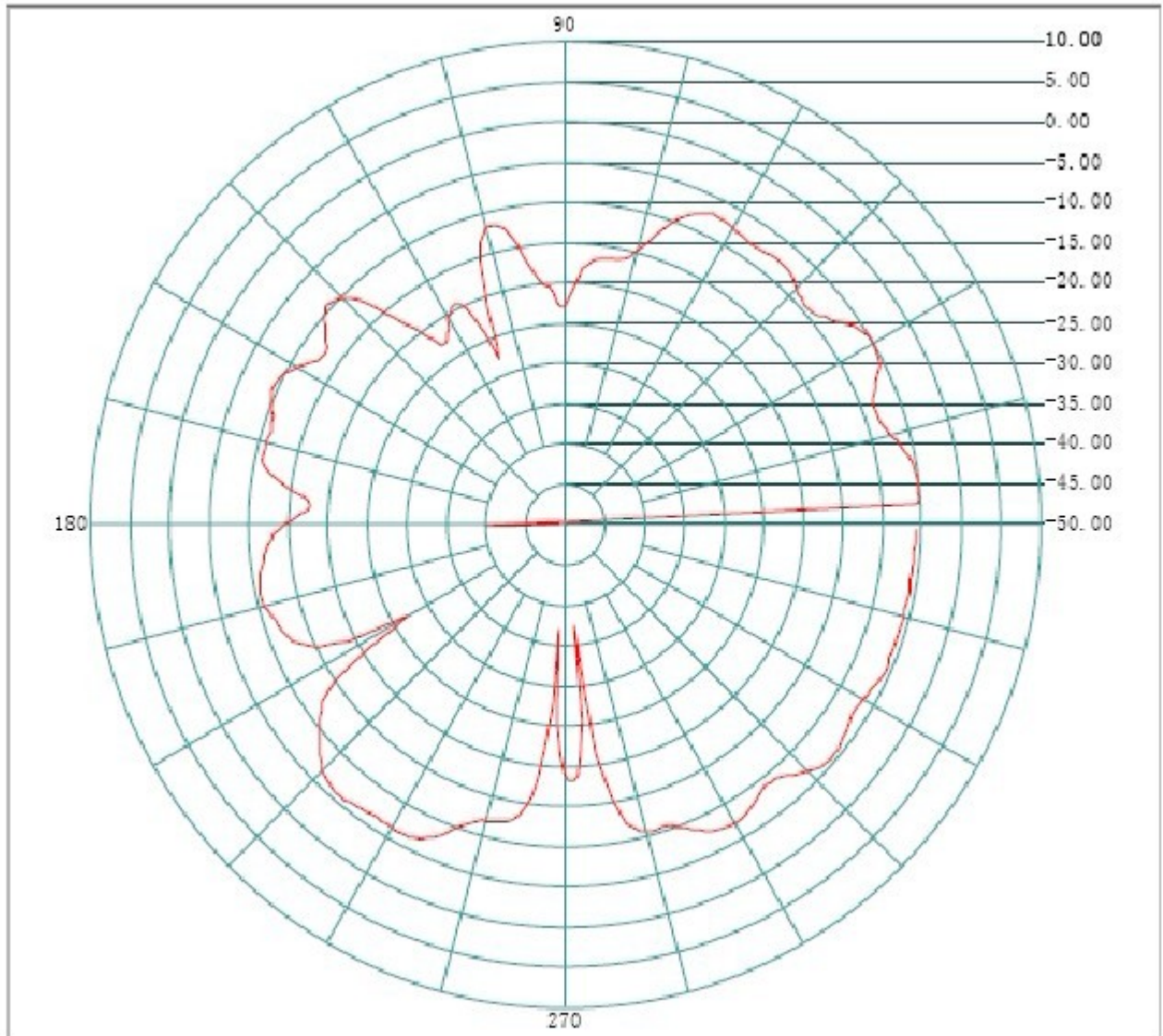

Frequency(MHZ): **2480**

Antenna Polarity: **Vertical**

Maximum Gain(dBi): **-5.33**

Average Gain(dBi) : **-9.81**

Minimum Gain(dBi): **-61.46**