



FCC TEST REPORT

FCC ID:2BFMV-S6-2

Report Number..... : ZKT-240620L6988E-3

Date of Test..... June 20 to June 28, 2024

Date of issue..... : June 28, 2024

Total number of pages..... 59

Test Result : PASS

Testing Laboratory..... : Shenzhen ZKT Technology Co., Ltd.

Address : 1/F, No. 101, Building B, No. 6, Tangwei Community Industrial Avenue, Fuhai Street, Bao'an District, Shenzhen, China

Applicant's name : **Shenzhen Chaoying Photoelectric Co., Ltd.**

Address : 7 / F, building 14, fuqingshan, Tangtou third industrial zone, Tangtou community, Shiyan street, Bao'an District, Shenzhen

Manufacturer's name : **Shenzhen Chaoying Photoelectric Co., Ltd.**

Address : 7 / F, building 14, fuqingshan, Tangtou third industrial zone, Tangtou community, Shiyan street, Bao'an District, Shenzhen

Test specification:

Standard..... : FCC CFR Title 47 Part 15 Subpart C Section 15.407
ANSI C63.10:2013
KDB 789033 D02 v01r02

Test procedure..... : /

Non-standard test method : N/A

Test Report Form No..... : TRF-EL-113_V0

Test Report Form(s) Originator..... : ZKT Testing

Master TRF : Dated: 2020-01-06

This device described above has been tested by ZKT, and the test results show that the equipment under test (EUT) is in compliance with the FCC requirements. And it is applicable only to the tested sample identified in the report.

This report shall not be reproduced except in full, without the written approval of ZKT, this document may be altered or revised by ZKT, personal only, and shall be noted in the revision of the document.

Product name..... : **Projector**

Trademark : N/A

Model/Type reference..... : S6-2,S6-1,S6S,S6-3,S6-4,S6-5,S6-6,S6-7,S6-8,S6-9,S6-10,Y20,
Y30,Y40,Y50,Y60,Y70,Y80,Y80PRO,Y90,Y90PRO

Ratings..... : AC110-240V 50/60Hz 1.5A



Testing procedure and testing location:

Testing Laboratory.....: Shenzhen ZKT Technology Co., Ltd.

Address.....: 1/F, No. 101, Building B, No. 6, Tangwei Community Industrial Avenue, Fuhai Street, Bao'an District, Shenzhen, China

Tested by (name + signature).....: Alen He

Reviewer (name + signature).....: Joe Liu

Approved (name + signature).....: Lake Xie





Table of Contents

	Page
1. VERSION	5
2.SUMMARY OF TEST RESULTS	6
2.1 TEST FACILITY	7
2.2 MEASUREMENT UNCERTAINTY	7
3. GENERAL INFORMATION	8
3.1 GENERAL DESCRIPTION OF EUT	8
3.3 BLOCK DIGRAM SHOWING THE CONFIGURATION OF SYSTEM TESTED	11
3.4 DESCRIPTION OF SUPPORT UNITS(CONDUCTED MODE)	11
3.5 EQUIPMENTS LIST FOR ALL TEST ITEMS	12
4.EMC EMISSION TEST	14
4.1 CONDUCTED EMISSION MEASUREMENT	14
4.1.1 POWER LINE CONDUCTED EMISSION LIMITS	14
4.1.2 TEST PROCEDURE	14
4.1.3 DEVIATION FROM TEST STANDARD	14
4.1.4 TEST SETUP	15
4.1.5 EUT OPERATING CONDITIONS	15
4.1.6 TEST RESULT	16
4.2 RADIATED EMISSION MEASUREMENT	18
4.2.1 APPLICABLE STANDARD	18
4.2.2 CONFORMANCE LIMIT	18
4.2.3 MEASURING INSTRUMENTS	18
4.2.4 TEST CONFIGURATION	19
4.2.5 TEST PROCEDURE	20
4.2.6 TEST RESULT	21
5.POWER SPECTRAL DENSITY TEST	26
5.1 APPLIED PROCEDURES / LIMIT	26
5.2 TEST PROCEDURE	27
5.3 DEVIATION FROM STANDARD	27
5.4 TEST SETUP	27
5.5 EUT OPERATION CONDITIONS	27
5.6 TEST RESULTS	28
6. 26DB & 99% EMISSION BANDWIDTH	32
6.1 APPLIED PROCEDURES / LIMIT	32
6.2 TEST PROCEDURE	32
6.3 EUT OPERATION CONDITIONS	33
6.4 TEST RESULTS	33



Table of Contents	Page
7.MAXIMUM CONDUCTED OUTPUT POWER	37
7.1 PPLIED PROCEDURES / LIMIT	37
7.2 TEST PROCEDURE	37
7.3 DEVIATION FROM STANDARD	38
7.4 TEST SETUP	38
7.5 EUT OPERATION CONDITIONS	38
7.6 TEST RESULTS	39
8.OUT OF BAND EMISSIONS	40
8.1 APPLICABLE STANDARD	40
8.2 TEST PROCEDURE	40
8.3 DEVIATION FROM STANDARD	40
8.4 TEST SETUP	40
8.5 EUT OPERATION CONDITIONS	41
8.6 TEST RESULTS	41
9.SPURIOUS RF CONDUCTED EMISSIONS	45
9.1 CONFORMANCE LIMIT	45
9.2 MEASURING INSTRUMENTS	45
9.3 TEST SETUP	45
9.4 TEST PROCEDURE	45
9.5 TEST RESULTS	45
10.FREQUENCY STABILITY MEASUREMENT	52
10.1 LIMIT	52
10.2 TEST PROCEDURES	52
10.3 TEST SETUP LAYOUT	52
10.4 EUT OPERATION DURING TEST	52
10.5 TEST RESULTS	52
11.ANTENNA REQUIREMENT	58
12. TEST SETUP PHOTO	59
13. EUT CONSTRUCTIONAL DETAILS	59



1. VERSION

Report No.	Version	Description	Approved
ZKT-240620L6988E-3	Rev.01	Initial issue of report	June 28, 2024



2.SUMMARY OF TEST RESULTS

Test procedures according to the technical standards:

FCC Part15 (15.407) , Subpart E			
Standard Section	Test Item	Judgment	Remark
15.209(a), 15.407 (b)(1) 15.407 (b)(4) 15.407 (b)(8)	Spurious Radiated Emissions	PASS	
15.207	Conducted Emission	PASS	
15.407 (a)(12) 15.1049	26 dB and 99% Emission Bandwidth	PASS	
15.407 (a)(1) 15.407 (a)(3)	Maximum Conducted Output Power	PASS	
2.1051, 15.407(b)(1) 15.407(b)(4)	Band Edge	PASS	
15.407 (a)(1) 15.407 (a)(3)	Power Spectral Density	PASS	
2.1051, 15.407(b)	Spurious Emissions at Antenna Terminals	PASS	
15.203	Antenna Requirement	PASS	

NOTE:

(1) "N/A" denotes test is not applicable in this Test Report



2.1 TEST FACILITY

Shenzhen ZKT Technology Co., Ltd.
Add. : 1/F, No. 101, Building B, No. 6, Tangwei Community Industrial Avenue, Fuhai Street, Bao'an District, Shenzhen, China

FCC Test Firm Registration Number: 692225
Designation Number: CN1299
IC Registered No.: 27033
CAB identifier: CN0110

2.2 MEASUREMENT UNCERTAINTY

The reported uncertainty of measurement $y \pm U$ · where expanded uncertainty U is based on a standard uncertainty multiplied by a coverage factor of $k=2$ · providing a level of confidence of approximately 95 % ·

No.	Item	Uncertain
	3m chamber Radiated spurious emission(9KHz-30MHz)	U=4.5dB
2	3m chamber Radiated spurious emission(30MHz-1GHz)	U=4.8dB
3	3m chamber Radiated spurious emission(1GHz-6GHz)	U=4.9dB
4	3m chamber Radiated spurious emission(6GHz-40GHz)	U=5.0dB
5	Conducted disturbance	U=3.2dB
6	RF Band Edge	U=1.68dB
7	RF power conducted	U=1.86dB
8	RF conducted Spurious Emission	U=2.2dB
9	RF Occupied Bandwidth	U=1.8dB
10	RF Power Spectral Density	U=1.75dB
11	humidity uncertainty	U=5.3%
12	Temperature uncertainty	U=0.59°C



3. GENERAL INFORMATION

3.1 GENERAL DESCRIPTION OF EUT

Product Name:	Projector	
Model No.:	S6-2,S6-1,S6S,S6-3,S6-4,S6-5,S6-6,S6-7,S6-8,S6-9,S6-10,Y20, Y30,Y40,Y50,Y60,Y70,Y80,Y80PRO,Y90,Y90PRO	
Model Different.:	All models covered in this report are the same with each other, except for different model No. and appearance (for color, silk-screen only) for trading purpose.	
Sample ID	ZKT-240528L5893E-1	
Sample(s) Status:	Engineer sample	
Product Description	IEEE 802.11 WLAN Mode Supported	<input checked="" type="checkbox"/> 802.11a/ac/n (20MHz channel bandwidth) <input checked="" type="checkbox"/> 802.11ac/n (40MHz channel bandwidth) <input checked="" type="checkbox"/> 802.11ac(80MHz channel bandwidth)
	Data Rate	802.11a 802.11/ac/n(HT20/HT40):MCS0-MCS15; 802.11ac(VHT80):NSS1, MCS0-MCS9
	Modulation	OFDM with BPSK/QPSK/16QAM/64QAM/256QAM for 802.11a/n/ac;
	Operating Frequency Range	<input checked="" type="checkbox"/> 5180-5240MHz for 802.11a/ac/n(HT20); 5190-5230MHz for 802.11ac/n(HT40); 5210MHz for 802.11 ac80;
	Number of Channels	<input checked="" type="checkbox"/> 4 channels for 802.11a/ac/n20 in the 5180-5240MHz band ; 2 channels for 802.11 ac/n40 in the 5190-5230 MHz band ; 1 channels for 802.11 ac80 in the 5210MHz band ;;
Channel List	Please refer to the Note 2.	
Antenna Type:	FPCB Antenna	
Antenna gain:	2.13dBi	
Power supply:	AC110-240V 50/60Hz 1.5A	
SWITCHING POWER ADAPTER:	N/A	
Battery:	N/A	

Note:

For a more detailed features description, please refer to the manufacturer's specifications or the User's Manual.



802.11a/ac/n(20MHz) Frequency Channel							
Channel	Frequency (MHz)	Channel	Frequency (MHz)	Channel	Frequency (MHz)	Channel	Frequency (MHz)
36	5180	44	5220	-	-	-	-
40	5200	48	5240	-	-	-	-

802.11ac/n(40MHz) Frequency Channel							
Channel	Frequency (MHz)	Channel	Frequency (MHz)	Channel	Frequency (MHz)	Channel	Frequency (MHz)
38	5190	-	-	-	-	-	-
46	5230	-	-	-	-	-	-

802.11ac (80MHz) Frequency Channel	
Channel	Frequency (MHz)
42	5210



3.2 DESCRIPTION OF TEST MODES

Transmitting mode	Keep the EUT in continuously transmitting mode
Remark: During the test, the duty cycle >98%, the test voltage was tuned from 85% to 115% of the nominal rated supply voltage, and found that the worst case was under the nominal rated supply condition. So the report just shows that condition's data.	

Pretest Mode	Description
Mode 1	802.11a /ac / n 20 CH36/ CH40/ CH 48
Mode 2	802.11ac / n 40 CH38/ CH 46
Mode 3	802.11 ac80 CH 42
Mode 4	Link Mode

Conducted Emission	
Final Test Mode	Description
Mode 5	Link Mode

For Radiated Emission	
Final Test Mode	Description
Mode 1	802.11a /ac / n 20 CH36/ CH40/ CH 48
Mode 2	802.11ac / n 40 CH38/ CH 46
Mode 3	802.11 ac80 CH 42

Note:

(1) The measurements are performed at all Bit Rate of Transmitter, the worst data was reported.



Test Software	Realtek Test Tool
Power level setup	<10dBm

3.3 BLOCK DIGRAM SHOWING THE CONFIGURATION OF SYSTEM TESTED

Conducted Emission

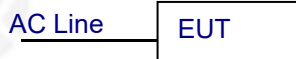

Radiated Emission

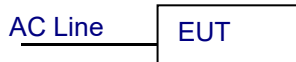

Conducted Spurious

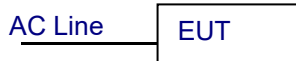

3.4 DESCRIPTION OF SUPPORT UNITS(CONDUCTED MODE)

The EUT has been tested as an independent unit together with other necessary accessories or support units. The following support units or accessories were used to form a representative test configuration during the tests.

Item	Equipment	Mfr/Brand	Model/Type No.	Series No.	Note
E-1	Projector	N/A	S6-2	Projector	EUT

Item	Shielded Type	Ferrite Core	Length	Note

Note:

- (1) The support equipment was authorized by Declaration of Confirmation.
- (2) For detachable type I/O cable should be specified the length in cm in 『Length』 column.



3.5 EQUIPMENTS LIST FOR ALL TEST ITEMS

Radiation emissions& Radio Test equipment

Item	Equipment	Manufacturer	Type No.	Serial No.	Firmware Version	Last calibration	Calibrated until
1	Spectrum Analyzer (9kHz-26.5GHz)	KEYSIGHT	9020A	MY55370835	A.17.05	Nov. 02, 2023	Nov. 01, 2024
2	Spectrum Analyzer (10kHz-39.9GHz)	R&S	FSV40-N	100363	1.71 SP2	Nov. 02, 2023	Nov. 01, 2024
3	EMI Test Receiver (9kHz-7GHz)	R&S	ESCI7	100969	4.32	Nov. 02, 2023	Nov. 01, 2024
4	Bilog Antenna (30MHz-1500MHz)	Schwarzbeck	VULB9168	N/A	N/A	Nov. 13, 2023	Nov. 12, 2024
5	Horn Antenna (1GHz-18GHz)	Agilent	AH-118	071145	N/A	Nov. 13, 2023	Nov. 12, 2024
6	Horn Antenna (15GHz-40GHz)	A.H.System	SAS-574	588	N/A	Nov. 13, 2023	Nov. 12, 2024
7	Loop Antenna	TESEQ	HLA6121	58357	N/A	Nov. 16, 2023	Nov. 15, 2024
8	Amplifier (30-1000MHz)	EM Electronics	EM330 Amplifier	60747	N/A	Nov. 02, 2023	Nov. 01, 2024
9	Amplifier (1GHz-26.5GHz)	HuiPu	8449B	3008A00315	N/A	Nov. 02, 2023	Nov. 01, 2024
10	Amplifier (500MHz-40GHz)	QuanJuDa	DLE-161	097	N/A	Nov. 02, 2023	Nov. 01, 2024
11	Test Cable	N/A	R-01	N/A	N/A	Nov. 02, 2023	Nov. 01, 2024
12	Test Cable	N/A	R-02	N/A	N/A	Nov. 02, 2023	Nov. 01, 2024
13	Test Cable	N/A	R-03	N/A	N/A	Nov. 02, 2023	Nov. 01, 2024
14	Test Cable	N/A	RF-01	N/A	N/A	Nov. 02, 2023	Nov. 01, 2024
15	Test Cable	N/A	RF-02	N/A	N/A	Nov. 02, 2023	Nov. 01, 2024
16	Test Cable	N/A	RF-03	N/A	N/A	Nov. 02, 2023	Nov. 01, 2024
17	ESG Signal Generator	Agilent	E4421B	N/A	B.03.84	Nov. 02, 2023	Nov. 01, 2024
18	Signal Generator	Agilent	N5182A	N/A	A.01.87	Nov. 02, 2023	Nov. 01, 2024
19	Magnetic Field Probe Tester	Narda	ELT-400	0-0344	N/A	Nov. 16, 2023	Nov. 15, 2024
20	Wideband Radio Communication Test	R&S	CMW500	106504	V 3.7.22	Nov. 02, 2023	Nov. 01, 2024
21	MWRF Power Meter Test system	MW	MW100-RF CB	N/A	N/A	Nov. 02, 2023	Nov. 01, 2024
22	D.C. Power Supply	LongWei	TPR-6405D	N/A	N/A	\	\
23	EMC Software	Frad	EZ-EMC	Ver.EMC-CO N 3A1.1	N/A	\	\
24	RF Software	MW	MTS8310	V2.0.0.0	N/A	\	\
25	Turntable	MF	MF-7802BS	N/A	N/A	\	\
26	Antenna tower	MF	MF-7802BS	N/A	N/A	\	\
27	Power Meter	KEYSIGHT	N1912AP	N/A	A.05.00	Nov. 02, 2023	Nov. 01, 2024



Conducted emissions Test

Item	Kind of Equipment	Manufacturer	Type No.	Serial No.	Firmware Version	Last calibration	Calibrated until
1	LISN	R&S	ENV216	101471	N/A	Nov. 14, 2023	Nov. 13, 2024
2	LISN	CYBERTEK	EM5040A	E1850400149	N/A	Nov. 02, 2023	Nov. 01, 2024
3	Test Cable	N/A	C-01	N/A	N/A	Nov. 02, 2023	Nov. 01, 2024
4	Test Cable	N/A	C-02	N/A	N/A	Nov. 02, 2023	Nov. 01, 2024
5	Test Cable	N/A	C-03	N/A	N/A	Nov. 02, 2023	Nov. 01, 2024
6	EMI Test Receiver	R&S	ESCI3	101393	4.42 SP3	Nov. 02, 2023	Nov. 01, 2024
7	Triple-Loop Antenna	N/A	RF300	N/A	N/A	Nov. 02, 2023	Nov. 01, 2024
8	Absorbing Clamp	DZ	ZN23201	15034	N/A	Nov. 07, 2023	Nov. 06, 2024
9	EMC Software	Frad	EZ-EMC	Ver.EMC-CON 3A1.1	N/A	\	\



4.EMC EMISSION TEST

4.1 CONDUCTED EMISSION MEASUREMENT

Test Requirement:	FCC Part15 C Section 15.207
Test Method:	ANSI C63.10:2013
Test Frequency Range:	150KHz to 30MHz
Receiver setup:	RBW=9KHz, VBW=30KHz, Sweep time=auto

4.1.1 POWER LINE CONDUCTED EMISSION Limits

FREQUENCY (MHz)	Limit (dBuV)		Standard
	Quasi-peak	Average	
0.15 -0.5	66 - 56 *	56 - 46 *	FCC
0.50 -5.0	56.00	46.00	FCC
5.0 -30.0	60.00	50.00	FCC

Note:

(1) *Decreases with the logarithm of the frequency.

4.1.2 TEST PROCEDURE

- a. The EUT was placed 0.8 meters from the horizontal ground plane with EUT being connected to the power mains through a line impedance stabilization network (LISN). All other support equipments powered from additional LISN(s). The LISN provide 50 Ohm/ 50uH of coupling impedance for the measuring instrument.
- b. Interconnecting cables that hang closer than 40 cm to the ground plane shall be folded back and forth in the center forming a bundle 30 to 40 cm long.
- c. I/O cables that are not connected to a peripheral shall be bundled in the center. The end of the cable may be terminated, if required, using the correct terminating impedance. The overall length shall not exceed 1 m.
- d. LISN at least 80 cm from nearest part of EUT chassis.
- e. For the actual test configuration, please refer to the related Item –EUT Test Photos.

4.1.3 DEVIATION FROM TEST STANDARD

No deviation



4.1.4 TEST SETUP

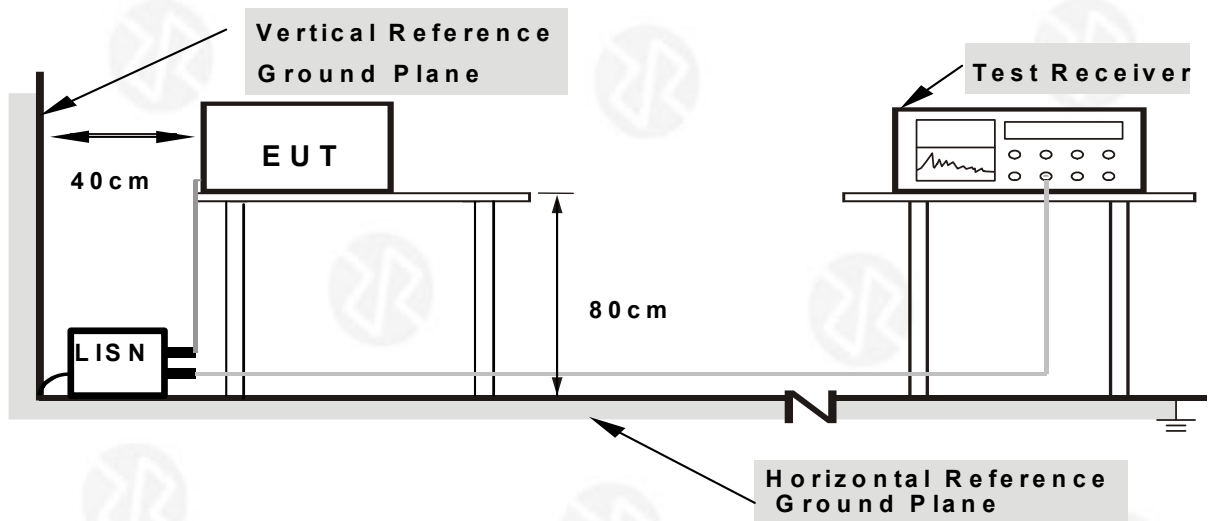

- Note:**
- 1.Support units were connected to second LISN.
 - 2.Both of LISNs (AMN) are 80 cm from EUT and at least 80 from other units and other metal planes

4.1.5 EUT OPERATING CONDITIONS

The EUT was configured for testing in a typical fashion (as a customer would normally use it). The EUT has been programmed to continuously transmit during test. This operating condition was tested and used to collect the included data.

We pretest AC 120V and AC 230V, the worst voltage was AC 120V and the data recording in the report.



4.1.6 TEST RESULT

Temperature :	26°C	Relative Humidity:	54%
Pressure :	101kPa	Phase :	L
Test Voltage :	AC 120V/60Hz		

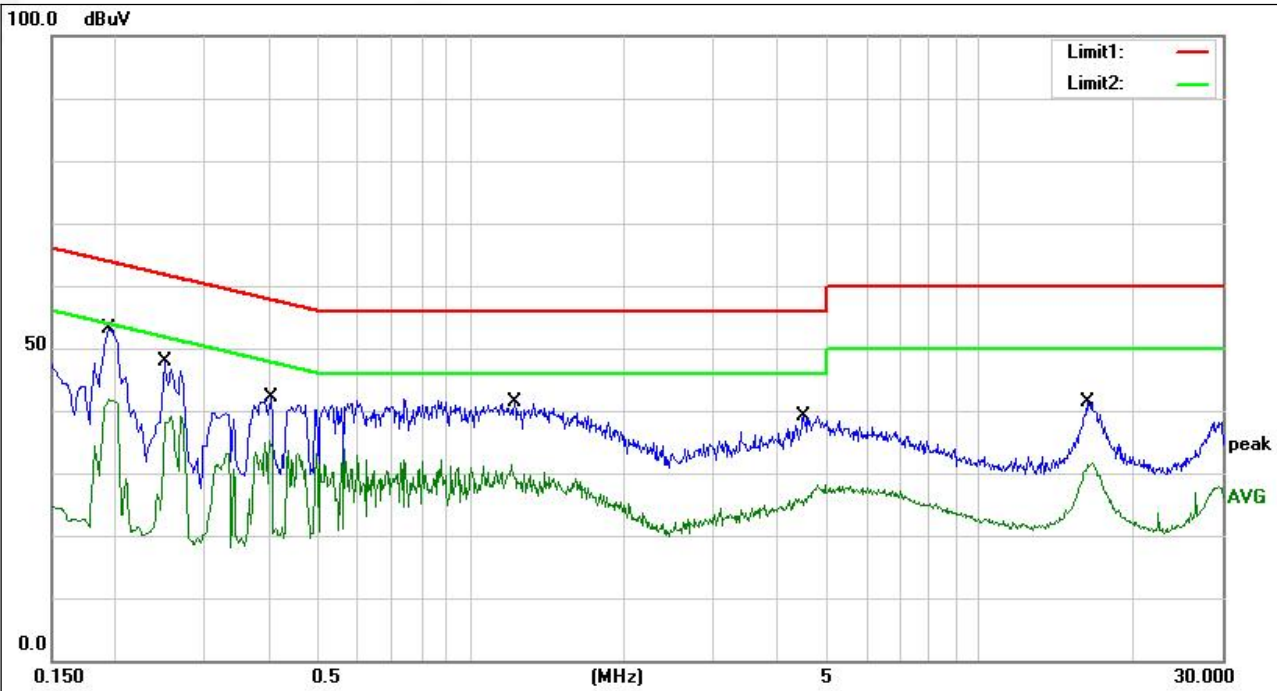

No.	Frequency (MHz)	Reading (dBuV)	Correction (dB)	Result (dBuV)	Limit (dBuV)	Margin (dB)	Remark
1	0.1940	33.40	19.77	53.17	63.86	-10.69	QP
2	0.1940	22.06	19.77	41.83	53.86	-12.03	AVG
3	0.2500	27.86	19.99	47.85	61.76	-13.91	QP
4	0.2500	19.08	19.99	39.07	51.76	-12.69	AVG
5	0.4060	22.22	20.01	42.23	57.73	-15.50	QP
6	0.4060	15.03	20.01	35.04	47.73	-12.69	AVG
7	1.2180	21.62	19.78	41.40	56.00	-14.60	QP
8	1.2180	11.61	19.78	31.39	46.00	-14.61	AVG
9	4.5220	19.20	19.83	39.03	56.00	-16.97	QP
10	4.5220	8.34	19.83	28.17	46.00	-17.83	AVG
11	16.2780	20.91	20.42	41.33	60.00	-18.67	QP
12	16.2780	11.20	20.42	31.62	50.00	-18.38	AVG

Notes:

1. An initial pre-scan was performed on the line and neutral lines with peak detector.
2. Quasi-Peak and Average measurement were performed at the frequencies with maximized peak emission.
3. Measurement Level = Reading level + Correct Factor



Temperature :	26°C	Relative Humidity:	54%
Pressure :	101kPa	Phase :	N
Test Voltage :	AC 120V/60Hz		

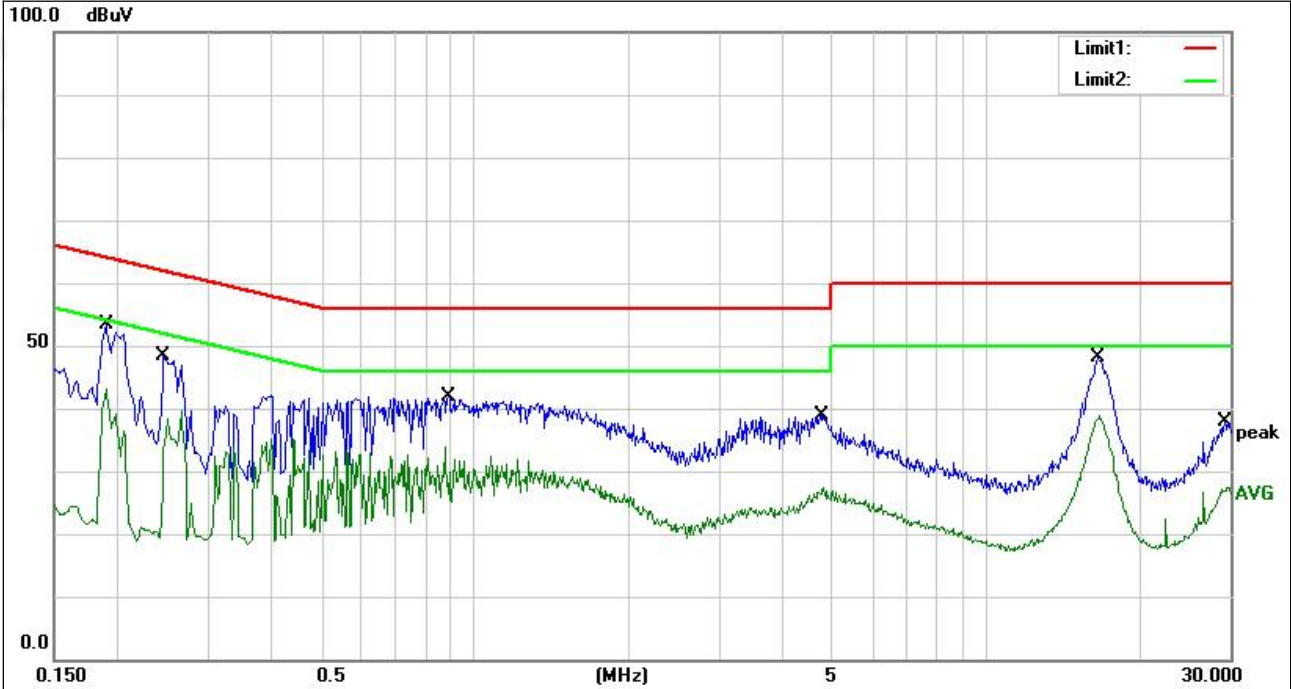

No.	Frequency (MHz)	Reading (dBuV)	Correction (dB)	Result (dBuV)	Limit (dBuV)	Margin (dB)	Remark
1	0.1900	33.66	19.77	53.43	64.04	-10.61	QP
2	0.1900	23.34	19.77	43.11	54.04	-10.93	AVG
3	0.2460	28.36	19.98	48.34	61.89	-13.55	QP
4	0.2460	19.64	19.98	39.62	51.89	-12.27	AVG
5	0.8860	22.02	19.79	41.81	56.00	-14.19	QP
6	0.8860	14.13	19.79	33.92	46.00	-12.08	AVG
7	4.7940	18.99	19.83	38.82	56.00	-17.18	QP
8	4.7940	7.53	19.83	27.36	46.00	-18.64	AVG
9	16.5340	27.78	20.43	48.21	60.00	-11.79	QP
10	16.5340	18.39	20.43	38.82	50.00	-11.18	AVG
11	29.3220	17.76	20.20	37.96	60.00	-22.04	QP
12	29.3220	7.19	20.20	27.39	50.00	-22.61	AVG

Notes:

1. An initial pre-scan was performed on the line and neutral lines with peak detector.
2. Quasi-Peak and Average measurement were performed at the frequencies with maximized peak emission.
3. Measurement Level = Reading level + Correct Factor



4.2 RADIATED EMISSION MEASUREMENT

4.2.1 APPLICABLE STANDARD

According to FCC Part 15.407(d) and 15.209

4.2.2 CONFORMANCE LIMIT

According to FCC Part 15.407(b)(7): radiated emissions which fall in the restricted bands, as defined in §15.205(a), must also comply with the radiated emission limits specified in §15.209(a) (see §15.205(c)).

According to FCC Part 15.205, Restricted bands

MHz	MHz	MHz	GHz
0.090-0.110	16.42-16.423	399.9-410	4.5-5.15
10.495-0.505	16.69475-16.69525	608-614	5.35-5.46
2.1735-2.1905	16.80425-16.80475	960-1240	7.25-7.75
4.125-4.128	25.5-25.67	1300-1427	8.025-8.5
4.17725-4.17775	37.5-38.25	1435-1626.5	9.0-9.2
4.20725-4.20775	73-74.6	1645.5-1646.5	9.3-9.5
6.215-6.218	74.8-75.2	1660-1710	10.6-12.7
6.26775-6.26825	123-138	2200-2300	14.47-14.5
8.291-8.294	149.9-150.05	2310-2390	15.35-16.2
8.362-8.366	156.52475-156.52525	2483.5-2500	17.7-21.4
8.37625-8.38675	156.7-156.9	2690-2900	22.01-23.12
8.41425-8.41475	162.0125-167.17	3260-3267	23.6-24.0
12.29-12.293	167.72-173.2	3332-3339	31.2-31.8
12.51975-12.52025	240-285	3345.8-3358	36.43-36.5
12.57675-12.57725	322-335.4	3600-4400	(2)
13.36-13.41			

20dBc in any 100 kHz bandwidth outside the operating frequency band. In case the emission fall within the restricted band specified on 15.205(a), then the 15.209(a) limit in the table below has to be followed.

Restricted Frequency(MHz)	Field Strength ($\mu\text{V}/\text{m}$)	Field Strength ($\text{dB}\mu\text{V}/\text{m}$)	Measurement Distance
0.009~0.490	2400/F(KHz)	20 log ($\mu\text{V}/\text{m}$)	300
0.490~1.705	2400/F(KHz)	20 log ($\mu\text{V}/\text{m}$)	30
1.705~30.0	30	29.5	30
30-88	100	40	3
88-216	150	43.5	3
216-960	200	46	3
Above 960	500	54	3

Limits of Radiated Emission Measurement(Above 1000MHz)

Frequency(MHz)	Class B ($\text{dB}\mu\text{V}/\text{m}$) (at 3M)	
	PEAK	AVERAGE
Above 1000	74	54

Remark :1. Emission level in $\text{dB}\mu\text{V}/\text{m}=20 \log (\mu\text{V}/\text{m})$

2. Measurement was performed at an antenna to the closed point of EUT distance of meters.

3. Distance extrapolation factor = $40 \log (\text{Specific distance}/ \text{test distance})$ (dB);

Limit line=Specific limits($\text{dB}\mu\text{V}$) + distance extrapolation factor.

4.2.3 MEASURING INSTRUMENTS

The Measuring equipment is listed in the section 6.3 of this test report.



4.2.4 TEST CONFIGURATION

1. For radiated emissions below 30MHz

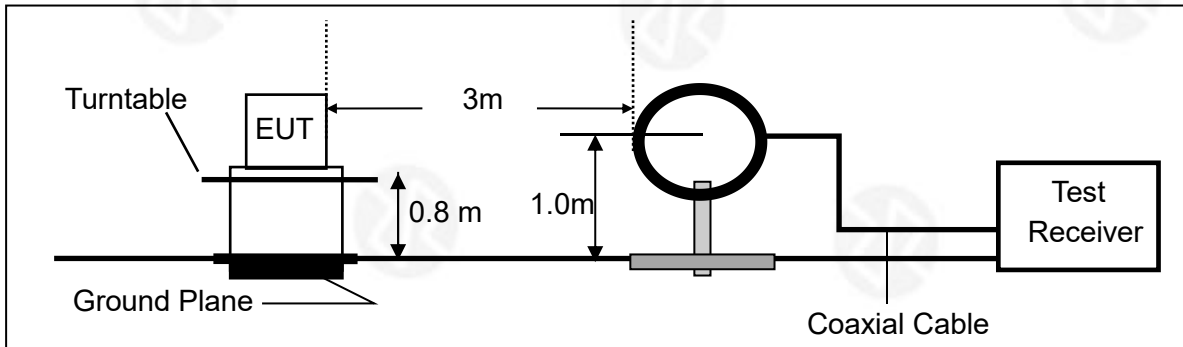

2. For radiated emissions from 30MHz to 1000MHz

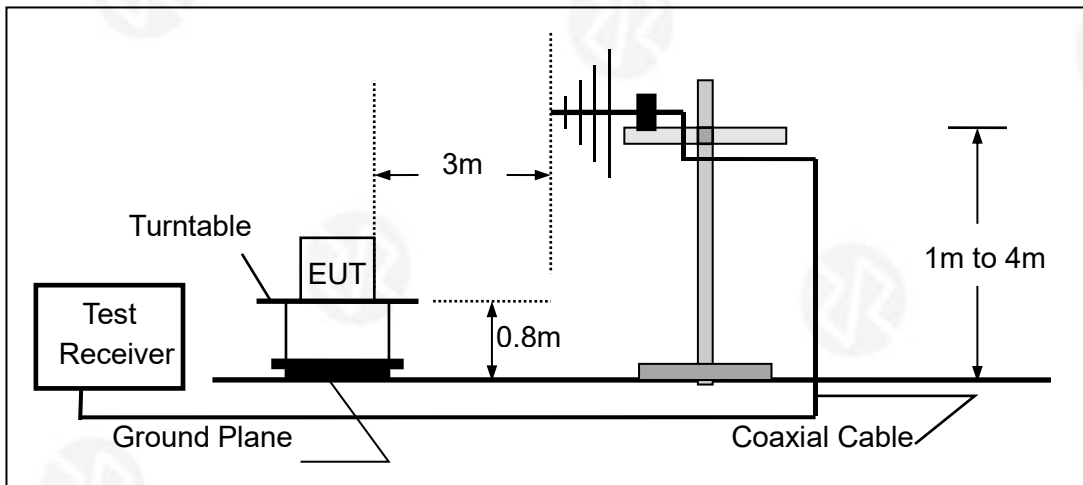

3. Radiated Emission Test-Up Frequency Above 1GHz

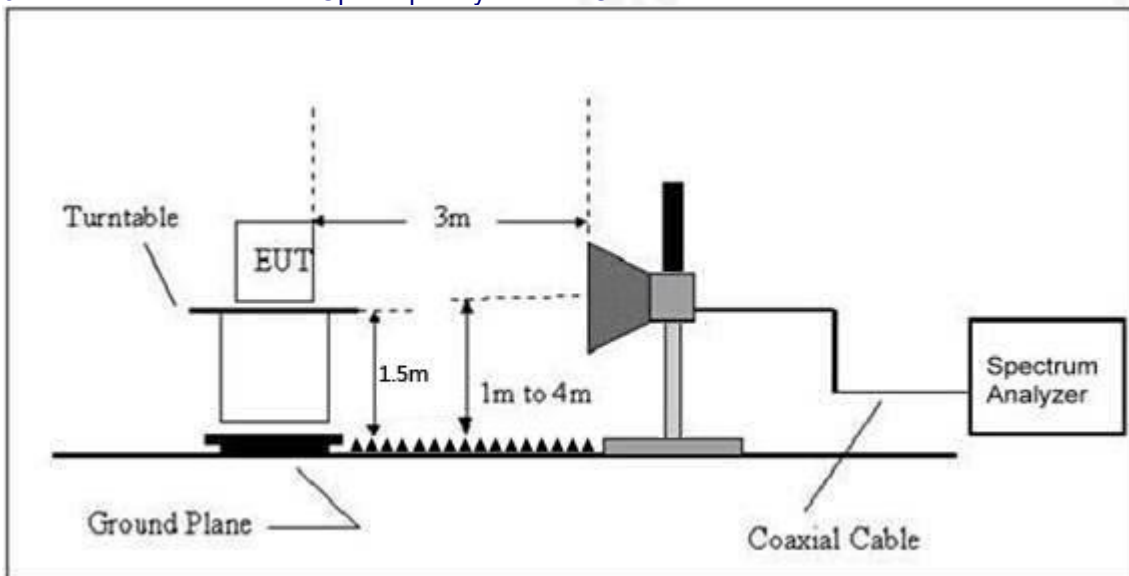



4.2.5 TEST PROCEDURE

The test site semi-anechoic chamber has met the requirement of NSA tolerance 4 dB according to the standards: ANSI C63.10-2013. The test distance is 3m. The setup is according to the requirements in Section 13.1.4.1 of ANSI C63.10-2013 and CAN/CSA-CEI/IEC CISPR 22.

This test is required for any spurious emission that falls in a Restricted Band, as defined in Section 15.205. It must be performed with the highest gain of each type of antenna proposed for use with the EUT.

Use the following spectrum analyzer settings:

Spectrum Parameter	Setting
Attenuation	Auto
Start Frequency	1000 MHz
Stop Frequency	10th carrier harmonic
RB / VB (emission in restricted band)	1 MHz / 1 MHz for Peak, 1 MHz / 10Hz for Average

Receiver Parameter	Setting
Attenuation	Auto
Start ~ Stop Frequency	9kHz~150kHz / RB 200Hz for QP
Start ~ Stop Frequency	150kHz~30MHz / RB 9kHz for QP
Start ~ Stop Frequency	30MHz~1000MHz / RB 120kHz for QP

- The measuring distance of at 3 m shall be used for measurements at frequency up to 1GHz. For frequencies above 1GHz, any suitable measuring distance may be used.
- The EUT was placed on the top of a rotating table 0.8 m for below 1GHz and 1.5m for above 1GHz the ground at a 3 meter. The table was rotated 360 degrees to determine the position of the highest radiation.
- The height of the equipment or of the substitution antenna shall be 0.8 m for below 1GHz and 1.5m for above 1GHz; the height of the test antenna shall vary between 1 m to 4 m. Both horizontal and vertical polarizations of the antenna are set to make the measurement.
- The initial step in collecting conducted emission data is a spectrum analyzer peak detector mode pre-scanning the measurement frequency range. Significant peaks are then marked and then Quasi Peak detector mode re-measured.
- If the Peak Mode measured value compliance with and lower than Quasi Peak Mode Limit, the EUT shall be deemed to meet QP Limits and then no additional QP Mode measurement performed.
- For the actual test configuration, please refer to the related Item –EUT Test Photos.

Note:

Both horizontal and vertical antenna polarities were tested and performed pretest to three orthogonal axis. The worst case emissions were reported

During the radiated emission test, the Spectrum Analyzer was set with the following configurations:

Frequency Band (MHz)	Function	Resolution bandwidth	Video Bandwidth
30 to 1000	QP	120 kHz	300 kHz
Above 1000	Peak	1 MHz	1 MHz
	Average	1 MHz	10 Hz

Note: for the frequency ranges below 30 MHz, a narrower RBW is used for these ranges but the measured value should add a RBW correction factor (RBWCF) where $RBWCF [dB] = 10 \cdot \lg(100 [kHz] / \text{narrower RBW [kHz]})$. , the narrower RBW is 1 kHz and RBWCF is 20 dB for the frequency 9 kHz to 150 kHz, and the narrower RBW is 10 kHz and RBWCF is 10 dB for the frequency 150 kHz to 30 MHz.



4.2.6 TEST RESULT

Between 9KHz – 30MHz

The emission from 9 kHz to 30MHz was pre-tested and found the result was 20dB lower than the limit, and according to 15.31(o) & RSS-Gen 6.13, the test result no need to reported.



Between 30MHz – 1GHz

Temperature:	26°C	Relative Humidity:	54%
Pressure:	101 kPa	Polarization:	Horizontal
Test Voltage:	AC 120V/60Hz		



No.	Frequency (MHz)	Reading (dBuV)	Correction (dB/m)	Result (dBuV/m)	Limit (dBuV/m)	Margin (dB)	Remark
1	49.3594	53.74	-21.33	32.41	40.00	-7.59	QP
2	58.2030	60.63	-25.14	35.49	40.00	-4.51	QP
3	131.7577	47.42	-18.28	29.14	43.50	-14.36	QP
4	153.7385	44.98	-18.30	26.68	43.50	-16.82	QP
5	552.8832	33.39	-8.28	25.11	46.00	-20.89	QP
6	869.1302	35.27	-4.65	30.62	46.00	-15.38	QP



Temperature:	26°C	Relative Humidity:	54%
Pressure:	101kPa	Polarization:	Vertical
Test Voltage:	AC 120V/60Hz		

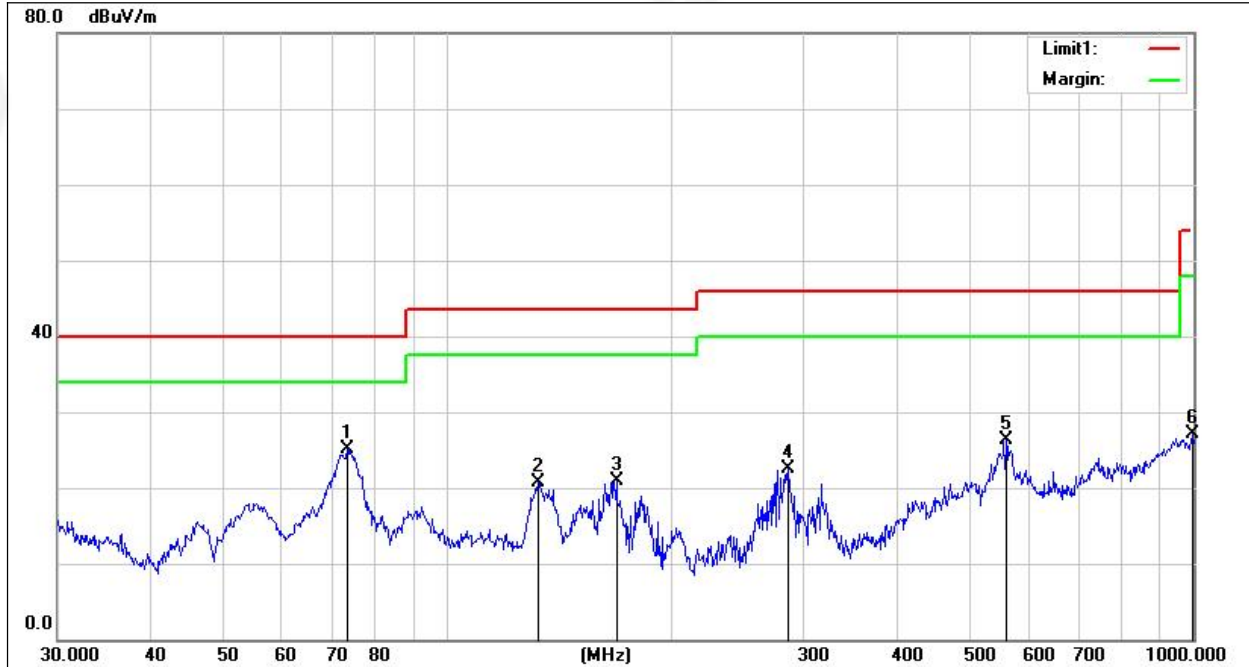

No.	Frequency (MHz)	Reading (dBUV)	Correction (dB/m)	Result (dBUV/m)	Limit (dBUV/m)	Margin (dB)	Remark
1	73.3593	50.09	-25.01	25.08	40.00	-14.92	QP
2	132.2205	39.07	-18.31	20.76	43.50	-22.74	QP
3	168.4138	40.65	-19.68	20.97	43.50	-22.53	QP
4	285.9778	38.91	-16.34	22.57	46.00	-23.43	QP
5	560.6928	34.12	-7.79	26.33	46.00	-19.67	QP
6	996.4995	29.33	-2.16	27.17	54.00	-26.83	QP

Remarks:

1. Final Level = Receiver Read level + Antenna Factor + Cable Loss – Pre-amplifier Factor
2. The emission levels of other frequencies are very lower than the limit and not show in test report.
3. The test data shows only the worst case 802.11n20 mode



Between 1GHz – 40GHz

Temperature :	26°C	Relative Humidity :	54%
Pressure :	1010 hPa	Test Voltage :	AC 120V/60Hz
Test Mode :	5.2G TX- 802.11n20		

802.11n20

Polar (H/V)	Frequency	Meter Reading	Pre-amplifier	Cable Loss	Antenna Factor	Emission Level	Limits	Margin	Detect or Type
	(MHz)	(dBuV)	(dB)	(dB)	(dB)	(dBuV/m)	(dBuV/m)	(dB)	
Low Channel:5180MHz									
V	5150.00	43.99	30.45	8.77	38.66	60.97	74.00	-13.03	PK
V	5150.00	34.43	30.45	8.77	38.66	51.41	54.00	-2.59	AV
V	10360.00	53.71	30.55	5.77	24.66	53.59	74.00	-20.41	PK
V	10360.00	43.46	30.55	5.77	24.66	43.34	54.00	-10.66	AV
V	15540.00	51.85	30.33	6.32	24.55	52.39	74.00	-21.61	PK
V	15540.00	42.90	30.33	6.32	24.55	43.44	54.00	-10.56	AV
V	20720.00	49.96	30.85	7.45	24.69	51.25	74.00	-22.75	PK
V	20720.00	42.96	30.85	7.45	24.69	44.25	54.00	-9.75	AV
V	25900.00	50.43	31.02	8.99	25.57	53.97	74.00	-20.03	PK
V	25900.00	43.14	31.02	8.99	25.57	46.68	54.00	-7.32	AV
H	5150.00	41.93	30.45	8.77	38.66	58.91	74.00	-15.09	PK
H	5150.00	32.29	30.45	8.77	38.66	49.27	54.00	-4.73	AV
H	10360.00	53.91	30.55	5.77	24.66	53.79	74.00	-20.21	PK
H	10360.00	43.49	30.55	5.77	24.66	43.37	54.00	-10.63	AV
H	15540.00	52.78	30.33	6.32	24.55	53.32	74.00	-20.68	PK
H	15540.00	43.12	30.33	6.32	24.55	43.66	54.00	-10.34	AV
H	20720.00	51.46	30.85	7.45	24.69	52.75	74.00	-21.25	PK
H	20720.00	43.63	30.85	7.45	24.69	44.92	54.00	-9.08	AV
H	25900.00	51.65	31.02	8.99	25.57	55.19	74.00	-18.81	PK
H	25900.00	42.80	31.02	8.99	25.57	46.34	54.00	-7.66	AV

Polar (H/V)	Frequency	Meter Reading	Pre-amplifier	Cable Loss	Antenna Factor	Emission Level	Limits	Margin	Detect or Type
	(MHz)	(dBuV)	(dB)	(dB)	(dB)	(dBuV/m)	(dBuV/m)	(dB)	
Middle Channel:5200MHz									
V	5150.00	41.92	30.45	8.77	38.66	58.90	74.00	-15.10	PK
V	5150.00	32.26	30.45	8.77	38.66	49.24	54.00	-4.76	AV
V	10400.00	53.14	30.55	5.77	24.66	53.02	74.00	-20.98	PK
V	10400.00	42.59	30.55	5.77	24.66	42.47	54.00	-11.53	AV
V	15600.00	53.56	30.33	6.32	24.55	54.10	74.00	-19.90	PK
V	15600.00	43.51	30.33	6.32	24.55	44.05	54.00	-9.95	AV
V	20800.00	52.17	30.85	7.45	24.69	53.46	74.00	-20.54	PK
V	20800.00	42.58	30.85	7.45	24.69	43.87	54.00	-10.13	AV
V	26000.00	51.13	31.02	8.99	25.57	54.67	74.00	-19.33	PK
V	26000.00	43.56	31.02	8.99	25.57	47.10	54.00	-6.90	AV
H	5150.00	42.83	30.45	8.77	38.66	59.81	74.00	-14.19	PK
H	5150.00	33.02	30.45	8.77	38.66	50.00	54.00	-4.00	AV
H	10400.00	52.67	30.55	5.77	24.66	52.55	74.00	-21.45	PK
H	10400.00	42.57	30.55	5.77	24.66	42.45	54.00	-11.55	AV
H	15600.00	50.98	30.33	6.32	24.55	51.52	74.00	-22.48	PK



H	15600.00	43.42	30.33	6.32	24.55	43.96	54.00	-10.04	AV
H	20800.00	53.56	30.85	7.45	24.69	54.85	74.00	-19.15	PK
H	20800.00	42.89	30.85	7.45	24.69	44.18	54.00	-9.82	AV
H	26000.00	52.11	31.02	8.99	25.57	55.65	74.00	-18.35	PK
H	26000.00	43.31	31.02	8.99	25.57	46.85	54.00	-7.15	AV

Polar (H/V)	Frequency	Meter Reading	Pre-ampli fier	Cable Loss	Antenna Factor	Emission Level	Limits	Margin	Detect or Type
	(MHz)	(dBuV)	(dB)	(dB)	(dB)	(dBuV/m)	(dBuV/ m)	(dB)	
High Channel:5240MHz									
V	5350.00	42.61	30.45	8.77	38.66	59.59	74.00	-14.41	PK
V	5350.00	32.13	30.45	8.77	38.66	49.11	54.00	-4.89	AV
V	10480.00	52.63	30.55	5.77	24.66	52.51	74.00	-21.49	PK
V	10480.00	43.46	30.55	5.77	24.66	43.34	54.00	-10.66	AV
V	15720.00	53.87	30.33	6.32	24.55	54.41	74.00	-19.59	PK
V	15720.00	43.56	30.33	6.32	24.55	44.10	54.00	-9.90	AV
V	20960.00	50.04	30.85	7.45	24.69	51.33	74.00	-22.67	PK
V	20960.00	43.33	30.85	7.45	24.69	44.62	54.00	-9.38	AV
V	26200.00	52.32	31.02	8.99	25.57	55.86	74.00	-18.14	PK
V	26200.00	43.65	31.02	8.99	25.57	47.19	54.00	-6.81	AV
H	5350.00	41.84	30.45	8.77	38.66	58.82	74.00	-15.18	PK
H	5350.00	32.21	30.45	8.77	38.66	49.19	54.00	-4.81	AV
H	10480.00	50.47	30.55	5.77	24.66	50.35	74.00	-23.65	PK
H	10480.00	43.38	30.55	5.77	24.66	43.26	54.00	-10.74	AV
H	15720.00	53.37	30.33	6.32	24.55	53.91	74.00	-20.09	PK
H	15720.00	43.53	30.33	6.32	24.55	44.07	54.00	-9.93	AV
H	20960.00	51.04	30.85	7.45	24.69	52.33	74.00	-21.67	PK
H	20960.00	43.61	30.85	7.45	24.69	44.90	54.00	-9.10	AV
H	26200.00	50.37	31.02	8.99	25.57	53.91	74.00	-20.09	PK
H	26200.00	42.75	31.02	8.99	25.57	46.29	54.00	-7.71	AV

Remark:

1. Emission Level = Meter Reading + Antenna Factor + Cable Loss – Pre-amplifier,
Margin= Emission Level - Limit
2. If peak below the average limit, the average emission was no test.
3. The amplitude of spurious emissions which are attenuated by more than 20dB below the permissible value has no need to be reported.
4. The worst mode is 802.11n20 , only the worst data is recorded.



5. POWER SPECTRAL DENSITY TEST

5.1 APPLIED PROCEDURES / LIMIT

According to FCC §15.407(3)

Power limits:

(1) For the band 5.15-5.25 GHz.

(i) For an outdoor access point operating in the band 5.15-5.25 GHz, the maximum power spectral density shall not exceed 17 dBm in any 1 megahertz band. If transmitting antennas of directional gain greater than 6 dBi are used, both the maximum conducted output power and the maximum power spectral density shall be reduced by the amount in dB that the directional gain of the antenna exceeds 6 dBi. The maximum e.i.r.p. at any elevation angle above 30 degrees as measured from the horizon must not exceed 125 mW (21 dBm).

(ii) For an indoor access point operating in the band 5.15-5.25 GHz, the maximum power spectral density shall not exceed 17 dBm in any 1 megahertz band. If transmitting antennas of directional gain greater than 6 dBi are used, both the maximum conducted output power and the maximum power spectral density shall be reduced by the amount in dB that the directional gain of the antenna exceeds 6 dBi.

(iii) For fixed point-to-point access points operating in the band 5.15-5.25 GHz, the maximum power spectral density shall not exceed 17 dBm in any 1 megahertz band. Fixed point-to-point U-NII devices may employ antennas with directional gain up to 23 dBi without any corresponding reduction in the maximum conducted output power or maximum power spectral density. For fixed point-to-point transmitters that employ a directional antenna gain greater than 23 dBi, a 1 dB reduction in maximum conducted output power and maximum power spectral density is required for each 1 dB of antenna gain in excess of 23 dBi. Fixed, point-to-point operations exclude the use of point-to-multipoint systems, omnidirectional applications, and multiple collocated transmitters transmitting the same information. The operator of the U-NII device, or if the equipment is professionally installed, the installer, is responsible for ensuring that systems employing high gain directional antennas are used exclusively for fixed, point-to-point operations.

(iv) For client devices in the 5.15-5.25 GHz band, the maximum power spectral density shall not exceed 11 dBm in any 1 megahertz band. If transmitting antennas of directional gain greater than 6 dBi are used, both the maximum conducted output power and the maximum power spectral density shall be reduced by the amount in dB that the directional gain of the antenna exceeds 6 dBi.

(2) For the 5.25-5.35 GHz and 5.47-5.725 GHz bands, the maximum conducted output power over the frequency bands of operation shall not exceed the lesser of 250 mW or $11 \text{ dBm} + 10 \log B$, where B is the 26 dB emission bandwidth in megahertz. In addition, the maximum power spectral density shall not exceed 11 dBm in any 1 megahertz band. If transmitting antennas of directional gain greater than 6 dBi are used, both the maximum conducted output power and the maximum power spectral density shall be reduced by the amount in dB that the directional gain of the antenna exceeds 6 dBi.

(3) For the band 5.725-5.85 GHz, the maximum conducted output power over the frequency band of operation shall not exceed 1 W. In addition, the maximum power spectral density shall not exceed 30 dBm in any 500-kHz band. If transmitting antennas of directional gain greater than 6 dBi are used, both the maximum conducted output power and the maximum power spectral density shall be reduced by the amount in dB that the directional gain of the antenna exceeds 6 dBi. However, fixed point-to-point U-NII devices operating in this band may employ transmitting antennas with directional gain greater than 6 dBi without any corresponding reduction in transmitter conducted power. Fixed, point-to-point operations exclude the use of point-to-multipoint systems, omnidirectional applications, and multiple collocated transmitters transmitting the same information. The operator of the U-NII device, or if the equipment is professionally installed, the installer, is responsible for ensuring that systems employing high gain directional antennas are used exclusively for fixed, point-to-point operations.



5.2 TEST PROCEDURE

For devices operating in the bands 5.15-5.25 GHz, 5.25-5.35 GHz, and 5.47-5.725 GHz, the above procedures make use of 1 MHz RBW to satisfy directly the 1 MHz reference bandwidth specified in § 15.407(a)(5). For devices operating in the band 5.725-5.85 GHz, the rules specify a measurement bandwidth of 500 kHz. Many spectrum analyzers do not have 500 kHz RBW, thus a narrower RBW may need to be used. The rules permit the use of a RBWs less than 1 MHz, or 500 kHz, “provided that the measured power is integrated over the full reference bandwidth” to show the total power over the specified measurement bandwidth (i.e., 1 MHz, or 500 kHz). If measurements are performed using a reduced resolution bandwidth (< 1 MHz, or < 500 kHz) and integrated over 1 MHz, or 500 KHz bandwidth, the following adjustments to the procedures apply:

- a) Set $RBW \geq 1/T$, where T is defined in section II.B.I.a).
- b) Set $VBW \geq 3 RBW$.
- c) If measurement bandwidth of Maximum PSD is specified in 500 kHz, add $10\log(500\text{kHz}/RBW)$ to the measured result, whereas RBW (< 500 KHz) is the reduced resolution bandwidth of the spectrum analyzer set during measurement.
- d) If measurement bandwidth of Maximum PSD is specified in 1 MHz, add $10\log(1\text{MHz}/RBW)$ to the measured result, whereas RBW (< 1 MHz) is the reduced resolution bandwidth of spectrum analyzer set during measurement.
- e) Care must be taken to ensure that the measurements are performed during a period of continuous transmission or are corrected upward for duty cycle.

Note: As a practical matter, it is recommended to use reduced RBW of 100 KHz for the sections 5.c) and 5.d) above, since RBW=100 KHZ is available on nearly all spectrum analyzers.

5.3 DEVIATION FROM STANDARD

No deviation.

5.4 TEST SETUP



5.5 EUT OPERATION CONDITIONS

The EUT tested system was configured as the statements of 2.1 Unless otherwise a special operating condition is specified in the follows during the testing.



5.6 TEST RESULTS

Temperature :	26 °C	Relative Humidity :	54%
Pressure :	1015 hPa	Test Voltage :	AC 120V/60Hz
Test Mode :	TX		

Test mode	Test Channel (MHz)	PSD [dBm/MHz]	Limit (dBm/MHz)	Result
802.11a	5180	0.521	11	Pass
	5200	0.460	11	Pass
	5240	0.289	11	Pass
802.11n(HT20)	5180	0.264	11	Pass
	5200	0.039	11	Pass
	5240	0.411	11	Pass
802.11n(HT40)	5190	-3.028	11	Pass
	5230	-1.130	11	Pass
802.11ac(VH20)	5180	0.233	11	Pass
	5200	0.060	11	Pass
	5240	-0.056	11	Pass
802.11ac(VH40)	5190	-2.958	11	Pass
	5230	-1.158	11	Pass
802.11ac(VH80)	5210	-5.604	11	Pass



(802.11a) PSD plot on channel 36

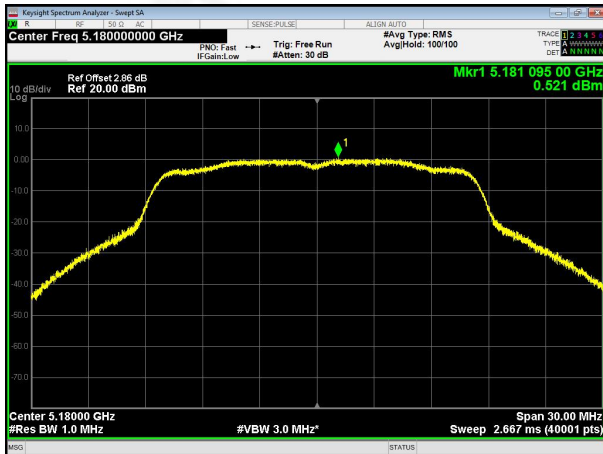

(802.11n20) PSD plot on channel 36

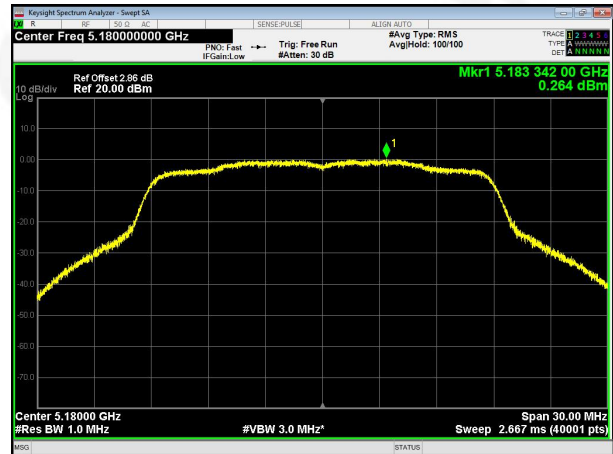

(802.11a) PSD plot on channel 40

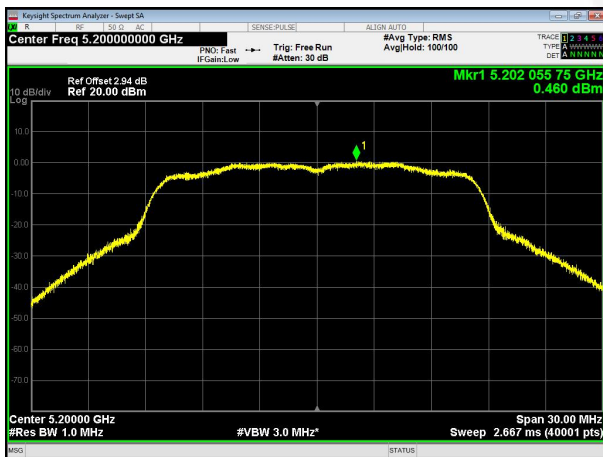

(802.11n20) PSD plot on channel 40

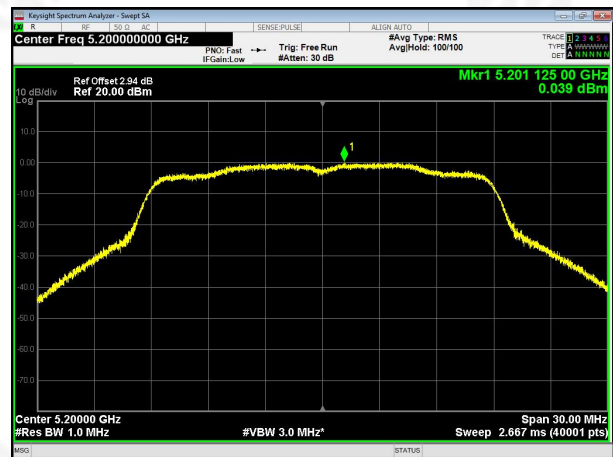

(802.11a) PSD plot on channel 48



(802.11n20) PSD plot on channel 48

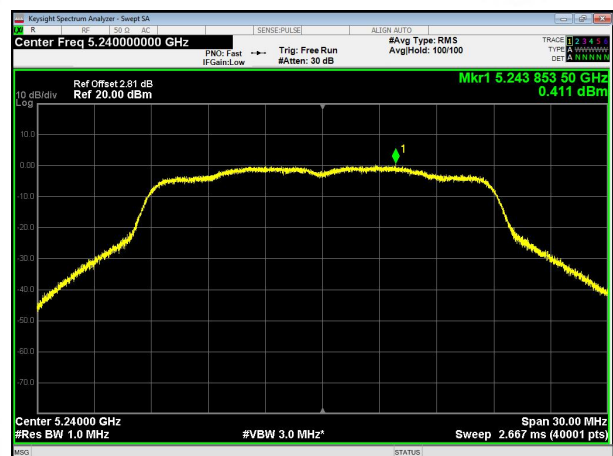



(802.11n40) PSD plot on channel 38

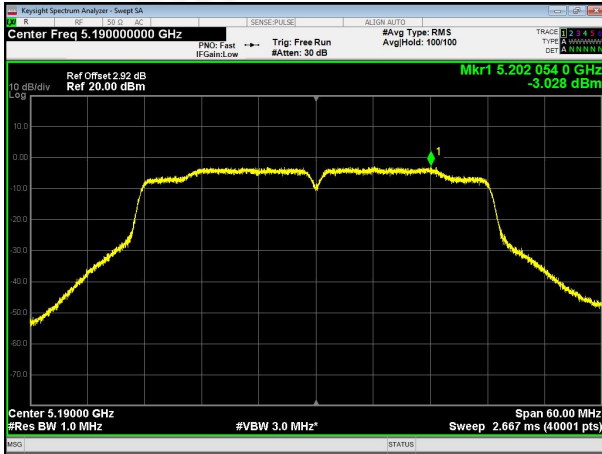

(802.11ac20) PSD plot on channel 36

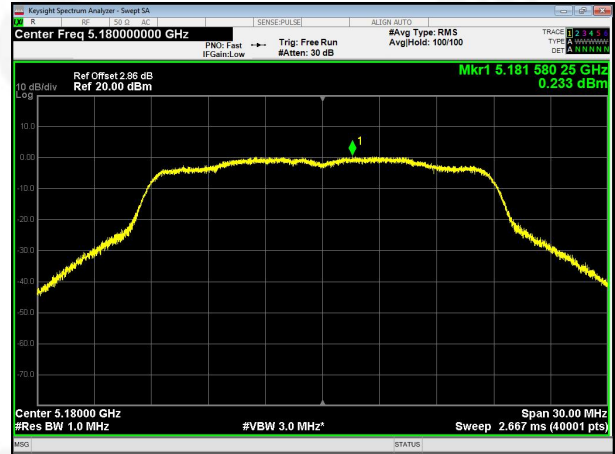

(802.11n40) PSD plot on channel 46

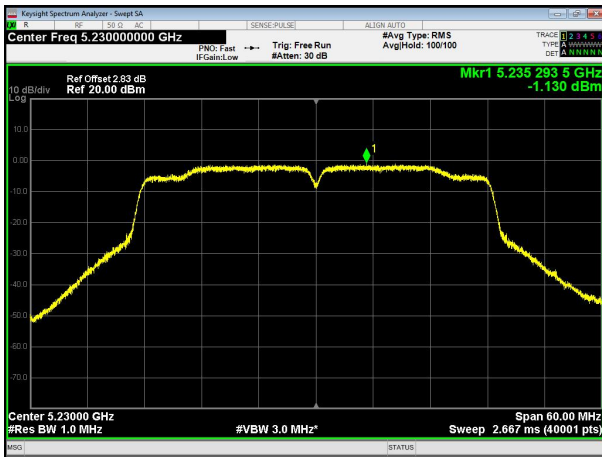

(802.11ac20) PSD plot on channel 40

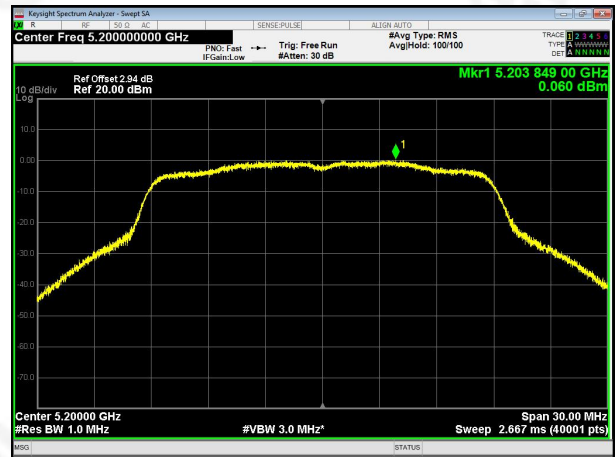

(802.11ac20) PSD plot on channel 48

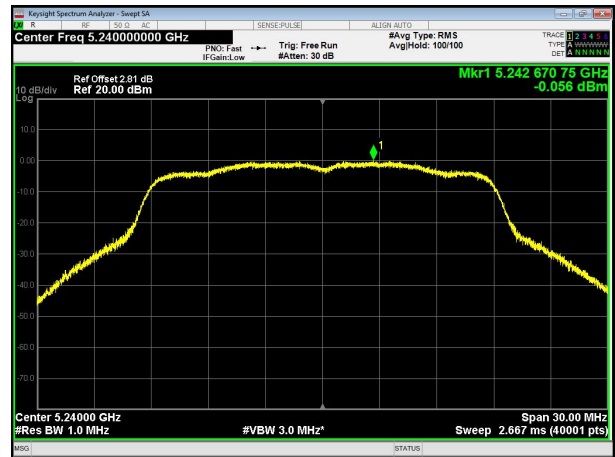



(802.11ac40) PSD plot on channel 38

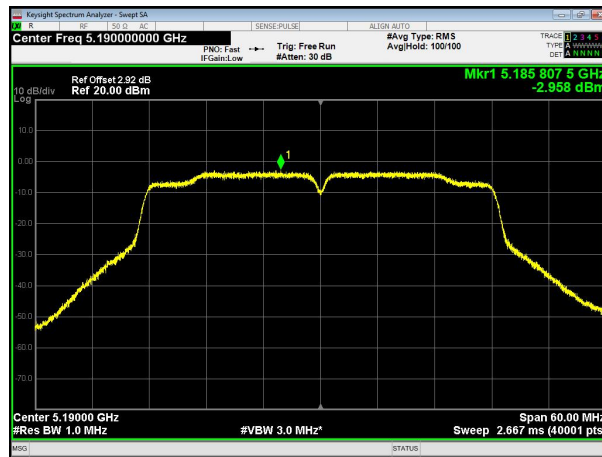

(802.11ac40) PSD plot on channel 46

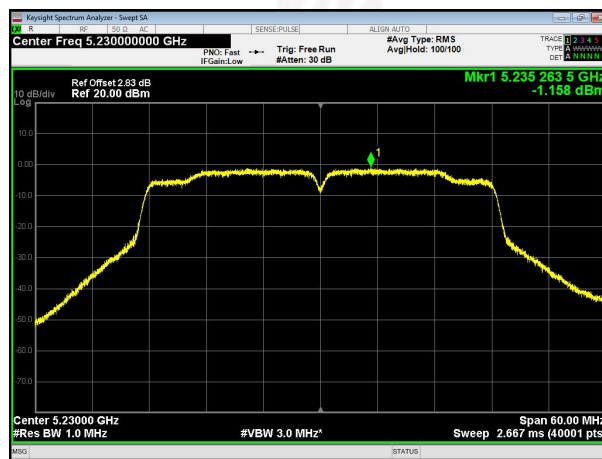

(802.11ac80) PSD plot on channel 42





6. 26DB & 99% EMISSION BANDWIDTH

6.1 APPLIED PROCEDURES / LIMIT

The maximum power spectral density is measured as a conducted emission by direct connection of a calibrated test instrument to the equipment under test. If the device cannot be connected directly, alternative techniques acceptable to the Commission may be used. Measurements in the 5.725-5.85 GHz band, the minimum bandwidth 6 dB bandwidth of U-NII devices shall be at least 500KHz. Measurements in the 5.15-5.25 GHz, 5.25-5.35 GHz, and the 5.47-5.725 GHz bands are made over a bandwidth of 1 MHz or the 26 dB emission bandwidth of the device, whichever is less. A narrower resolution bandwidth can be used, provided that the measured power is integrated over the full reference bandwidth.

6.2 TEST PROCEDURE

- a) Set RBW = 100KHz.
- b) Set the VBW > RBW.
- c) Detector = Peak.
- d) Trace mode = max hold.
- e) Measure the maximum width of the emission that is constrained by the frequencies associated with the two outermost amplitude points (upper and lower frequencies) that are attenuated by 6 dB relative to the maximum level measured in the fundamental emission.

The following procedure shall be used for measuring (99 %) power bandwidth:

1. Set center frequency to the nominal EUT channel center frequency.
2. Set span = 1.5 times to 5.0 times the OBW.
3. Set RBW = 1 % to 5 % of the OBW
4. Set VBW $\geq 3 \cdot$ RBW
5. Video averaging is not permitted. Where practical, a sample detection and single sweep mode shall be used. Otherwise, peak detection and max hold mode (until the trace stabilizes) shall be used.
6. Use the 99 % power bandwidth function of the instrument (if available).
7. If the instrument does not have a 99 % power bandwidth function, the trace data points are recovered and directly summed in power units. The recovered amplitude data points, beginning at the lowest frequency, are placed in a running sum until 0.5 % of the total is reached; that frequency is recorded as the lower frequency. The process is repeated until 99.5 % of the total is reached; that frequency is recorded as the upper frequency. The 99% occupied bandwidth is the difference between these two frequencies.





6.3 EUT OPERATION CONDITIONS

The EUT tested system was configured as the statements of 2.4 Unless otherwise a special operating condition is specified in the follows during the testing.

6.4 TEST RESULTS

Temperature :	26 °C	Relative Humidity :	54%
Pressure :	101kPa	Test Voltage :	AC 120V/60Hz
Test Mode :	TX		

Mode	Channel	Frequency (MHz)	26dB bandwidth (MHz)	99% bandwidth(MHz)	Limit(KHz)	Result
802.11a	CH36	5180	22.35	16.50	>500	Pass
	CH40	5200	21.96	16.52		
	CH48	5240	22.69	16.50		
802.11 n20	CH36	5180	22.70	17.63		
	CH40	5200	22.12	17.63		
	CH48	5240	21.95	17.61		
802.11 n40	CH38	5190	42.37	36.06		
	CH46	5230	42.55	36.03		
802.11 ac20	CH36	5180	22.32	17.59		
	CH40	5200	23.01	17.63		
	CH48	5240	22.58	17.62		
802.11 ac40	CH38	5190	43.03	36.02		
	CH46	5230	42.67	36.00		
802.11 AC80	CH42	5210	83.76	75.06		



Test plot

(802.11 a) 26dB Bandwidth plot on channel 36

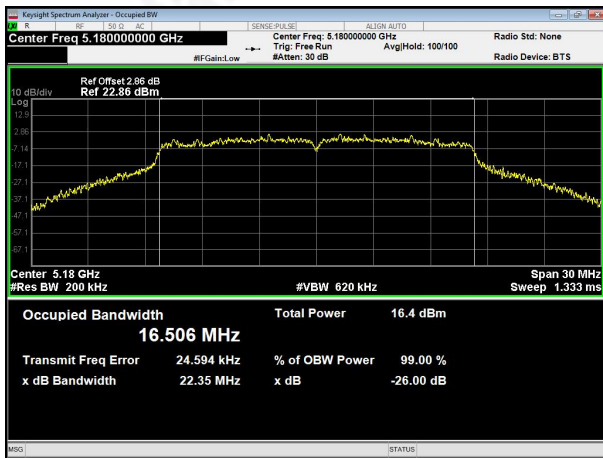

(802.11 a) 26dB Bandwidth plot on channel 40

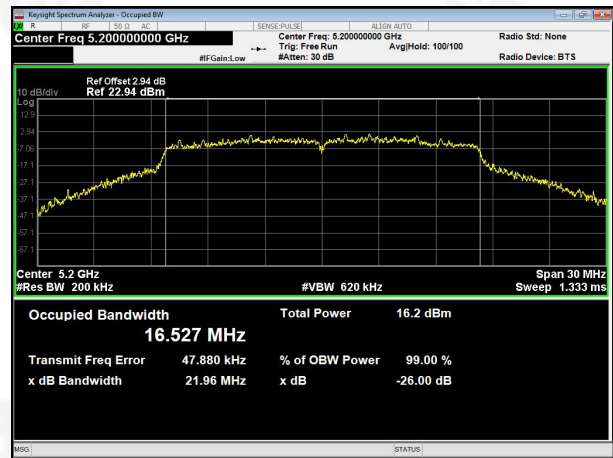

(802.11 a) 26dB Bandwidth plot on channel 48

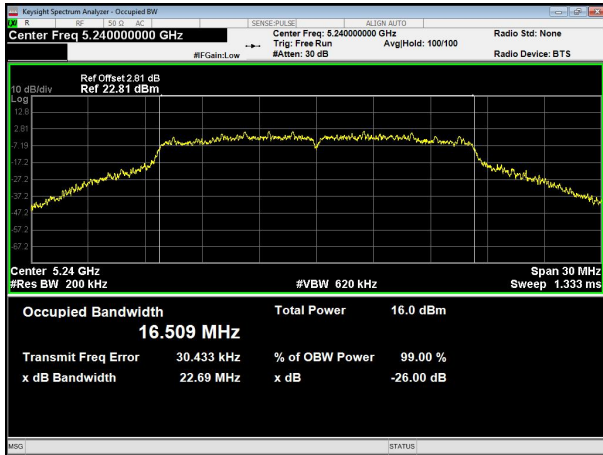



Test plot

(802.11 n20) 26dB Bandwidth plot on channel 36

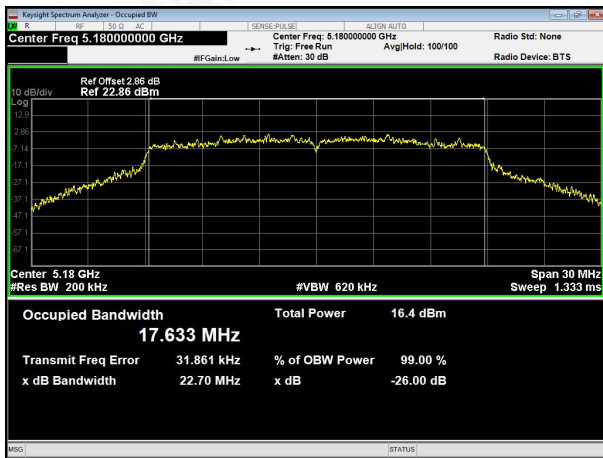

(802.11 n40) 26dB Bandwidth plot on channel 38

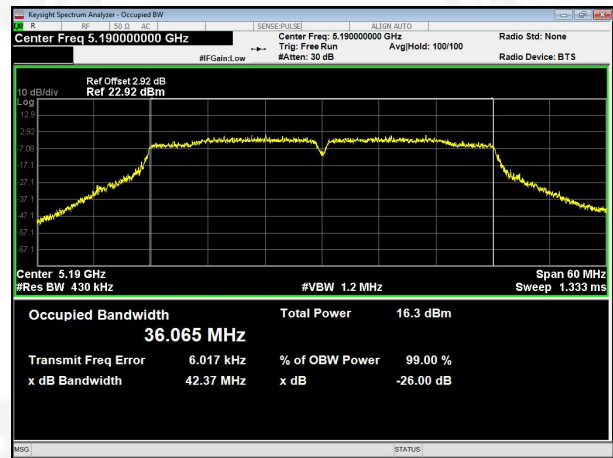

(802.11 n20) 26dB Bandwidth plot on channel 40

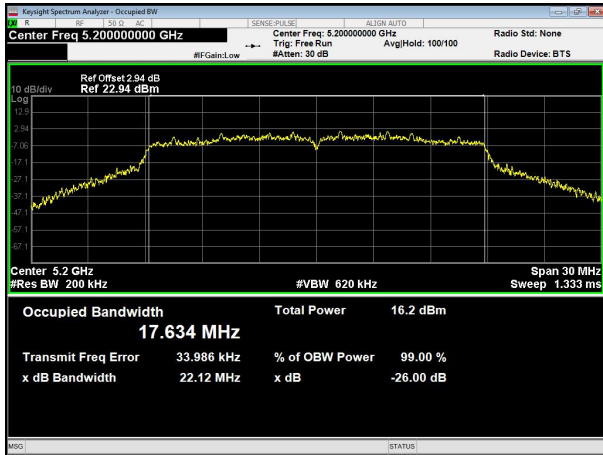

(802.11 n40) 26dB Bandwidth plot on channel 46

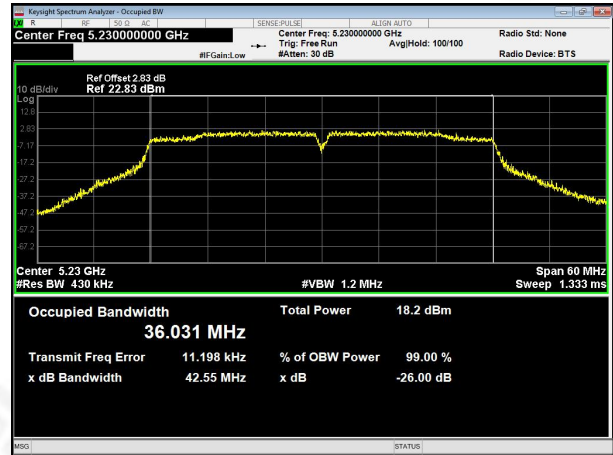

(802.11 n20) 26dB Bandwidth plot on channel 48

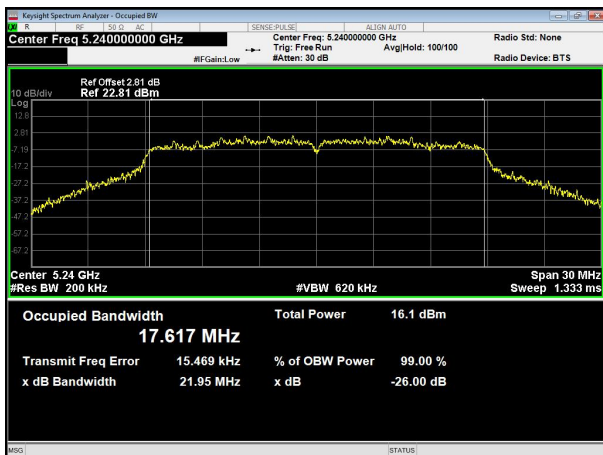



Test plot

(802.11ac20) 26dB Bandwidth plot on channel 36

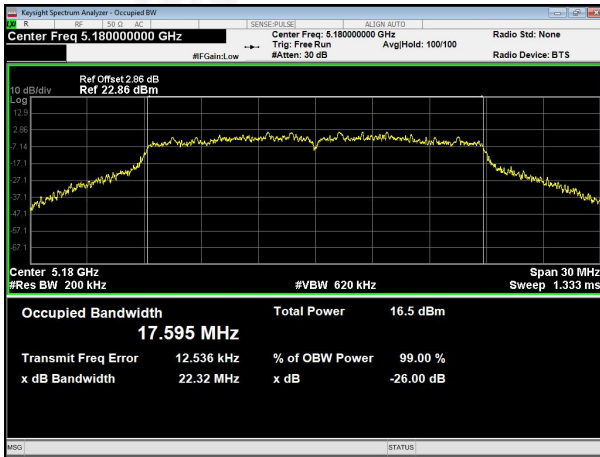

(802.11 ac40) 26dB Bandwidth plot on channel 38

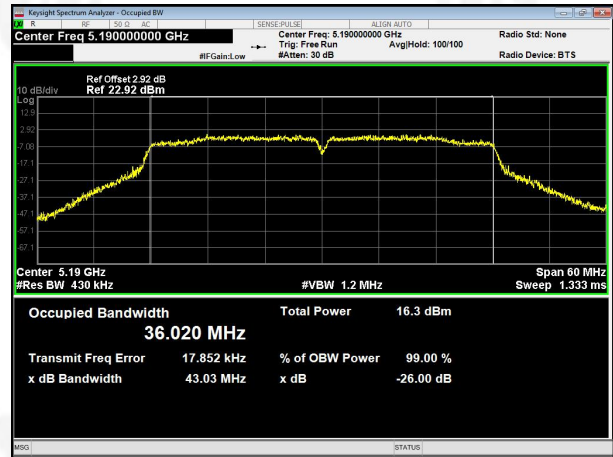

(802.11ac20) 26dB Bandwidth plot on channel 40

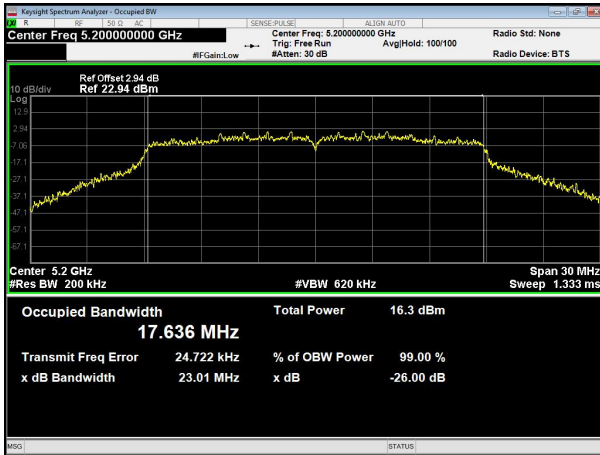

(802.11 ac40) 26dB Bandwidth plot on channel 46

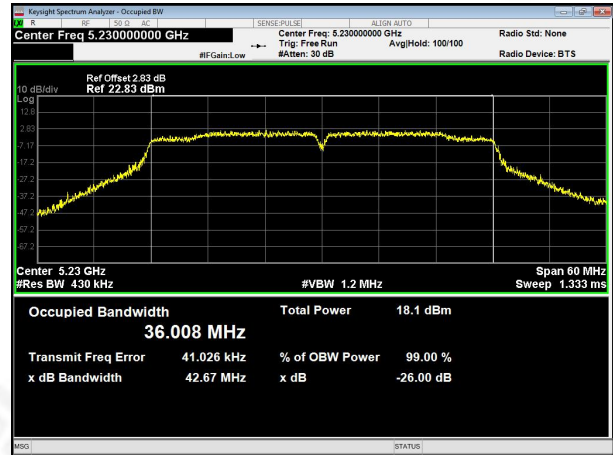

(802.11ac20) 26dB Bandwidth plot on channel 48



(802.11 ac80) 26dB Bandwidth plot on channel 42

