

TEST REPORT

Report No.: BCTC2403041214E

Applicant: Hunan China Dragon Technology Co., Ltd.

Product Name: Wi-sun module

Test Model: CDW-UVC7300-11(S9)

Tested Date: 2024-03-19 to 2024-04-25

Issued Date: 2024-04-26

Shenzhen BCTC Testing Co., Ltd.



FCC ID: 2BFLD-S9

Product Name: Wi-sun module
Trademark: N/A
Model/Type Reference: CDW-UVC7300-11(S9)
Prepared For: Hunan China Dragon Technology Co., Ltd.
Address: 3F, Kunpeng Industrial Park, No. 67 Ziyuan Road, Yuelu District, Xiang River, Changsha, China
Manufacturer: Hunan China Dragon Technology Co., Ltd.
Address: 3F, Kunpeng Industrial Park, No. 67 Ziyuan Road, Yuelu District, Xiang River, Changsha, China
Prepared By: Shenzhen BCTC Testing Co., Ltd.
Address: 1-2/F., Building B, Pengzhou Industrial Park, No.158, Fuyuan 1st Road, Zhancheng, Fuhai Subdistrict, Bao'an District, Shenzhen, Guangdong, China
Sample Received Date: 2024-03-19
Sample tested Date: 2024-03-19 to 2024-04-25
Issue Date: 2024-04-26
Report No.: BCTC2403041214E
Test Standards: FCC CFR Title 47 Part 15 Subpart C Section 15.247
FCC KDB 558074 D01 15.247 Meas Guidance v05r02
ANSI C63.10:2013
Test Results: PASS
Remark: This is Wi-Sun radio test report.

Tested by:

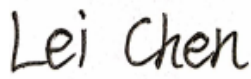

Lei Chen/Project Handler

Approved by:



Zero Zhou/Reviewer

The test report is effective only with both signature and specialized stamp. This result(s) shown in this report refer only to the sample(s) tested. Without written approval of Shenzhen BCTC Testing Co., Ltd, this report can't be reproduced except in full. The tested sample(s) and the sample information are provided by the client.



Table Of Content

	Page
Test Report Declaration	
1. Version	5
2. Test Summary	6
3. Measurement Uncertainty	7
4. Product Information And Test Setup	8
4.1 Product Information.....	8
4.2 Test Setup Configuration	8
4.3 Support Equipment	9
4.4 Channel List.....	10
4.5 Test Mode	11
4.6 Table Of Parameters Of Text Software Setting.....	11
5. Test Facility And Test Instrument Used.....	12
5.1 Test Facility.....	12
5.2 Test Instrument Used.....	12
6. Conducted Emissions.....	14
6.1 Block Diagram Of Test Setup.....	14
6.2 Limit	14
6.3 Test procedure.....	14
6.4 EUT operating Conditions	14
6.5 Test Result.....	15
7. Radiated Emissions.....	19
7.1 Block Diagram Of Test Setup.....	19
7.2 Limit	20
7.3 Test procedure.....	21
7.4 EUT operating Conditions	22
7.5 Test Result.....	22
8. Radiated Band Emission Measurement And Restricted Bands Of Operation	29
8.1 Block Diagram Of Test Setup.....	29
8.2 Limit	29
8.3 Test procedure.....	30
8.4 EUT operating Conditions	30
8.5 Test Result.....	31
9. Conducted Spurious Emission Measurement.....	32
9.1 Block Diagram Of Test Setup.....	32
9.2 Limit	32
9.3 Test procedure.....	32
9.4 Test Result.....	33
10. Occupy Bandwidth	36
10.1 Block Diagram Of Test Setup.....	36
10.2 Limit	36
10.3 Test procedure.....	36
10.4 Test Result.....	36
11. Conducted Output Power	39
11.1 Block Diagram Of Test Setup.....	39
11.2 Limit	39

 BCTC
 BCTC
 PPR
 Report

11.3	Test procedure	39
11.4	Test Result	39
12.	Hopping Channel Separation	42
12.1	Block Diagram Of Test Setup.....	42
12.2	Limit	42
12.3	Test procedure	42
12.4	Test Result.....	42
13.	Number Of Hopping Frequency.....	45
13.1	Block Diagram Of Test Setup.....	45
13.2	Limit	45
13.3	Test procedure	45
13.4	Test Result.....	46
14.	Dwell Time.....	47
14.1	Block Diagram Of Test Setup.....	47
14.2	Limit	47
14.3	Test procedure	47
14.4	Test Result.....	48
15.	Antenna Requirement	49
15.1	Limit	49
15.2	Test Result.....	49
16.	EUT Photographs.....	50
17.	EUT Test Setup Photographs.....	51

(Note: N/A Means Not Applicable)

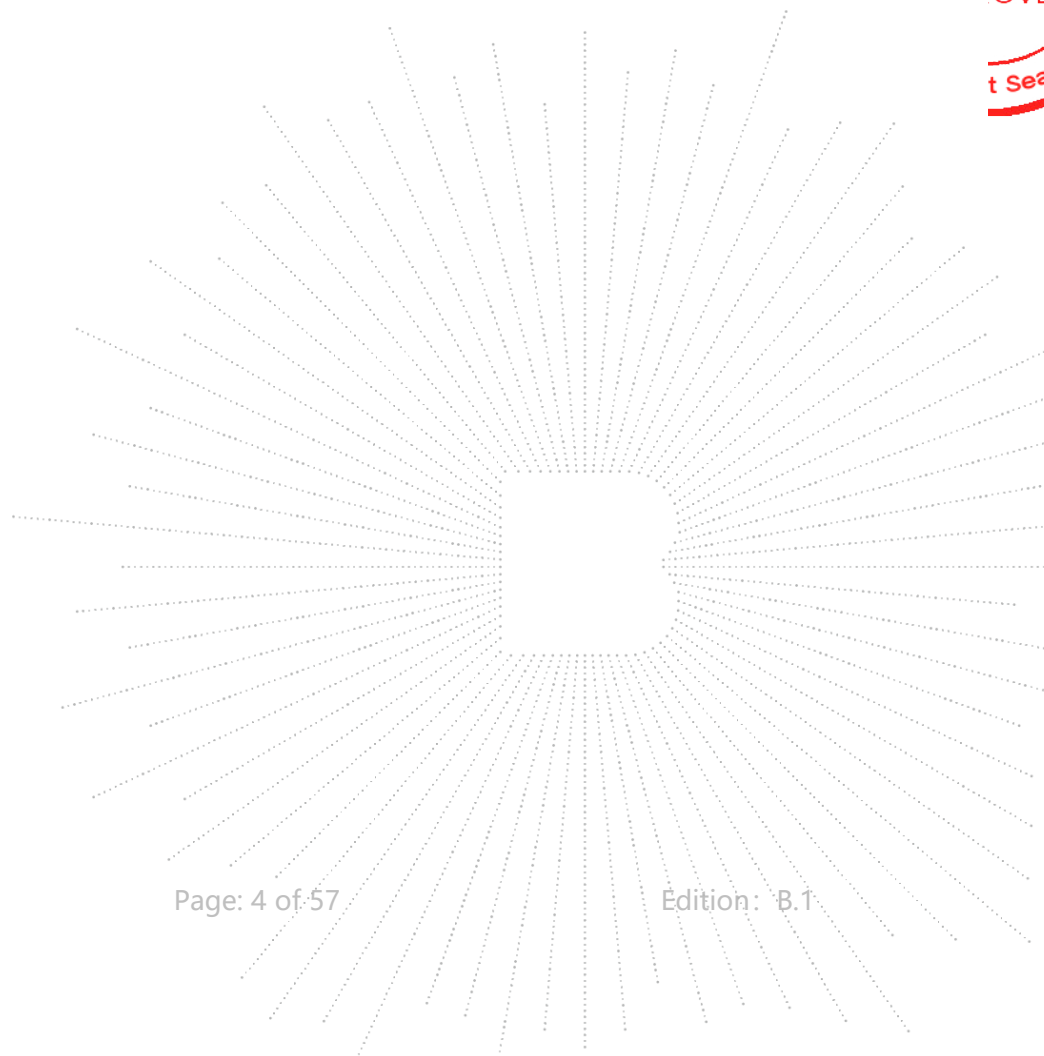

TE
TC
OV
t See

1. Version

Report No.	Issue Date	Description	Approved
BCTC2403041214E	2024-04-26	Original	Valid

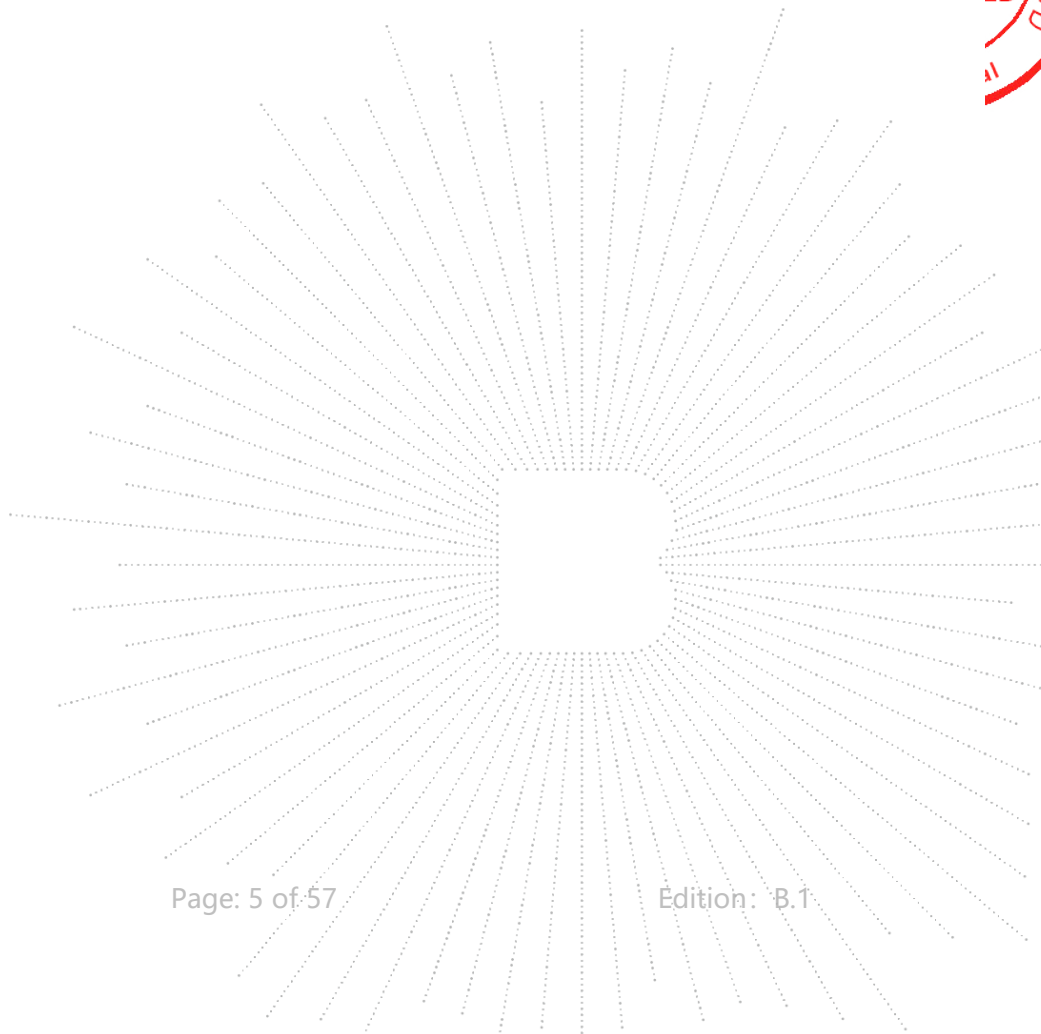

2. Test Summary

The Product has been tested according to the following specifications:

No.	Test Parameter	Clause No.	Results
1	Conducted Emission AC Power Port	§15.207	PASS
2	Conducted Peak Output Power	§15.247(b)	PASS
3	Occupied Bandwidth	§15.247(a)	PASS
4	Carrier Frequencies Separation	§15.247 (a)	PASS
5	Hopping Channel Number	§15.247 (a)(1)	PASS
6	Dwell Time	§15.247 (f)	PASS
7	Radiated Emission	§15.205/§15.209	PASS
8	Band Edge	§15.247(d)	PASS

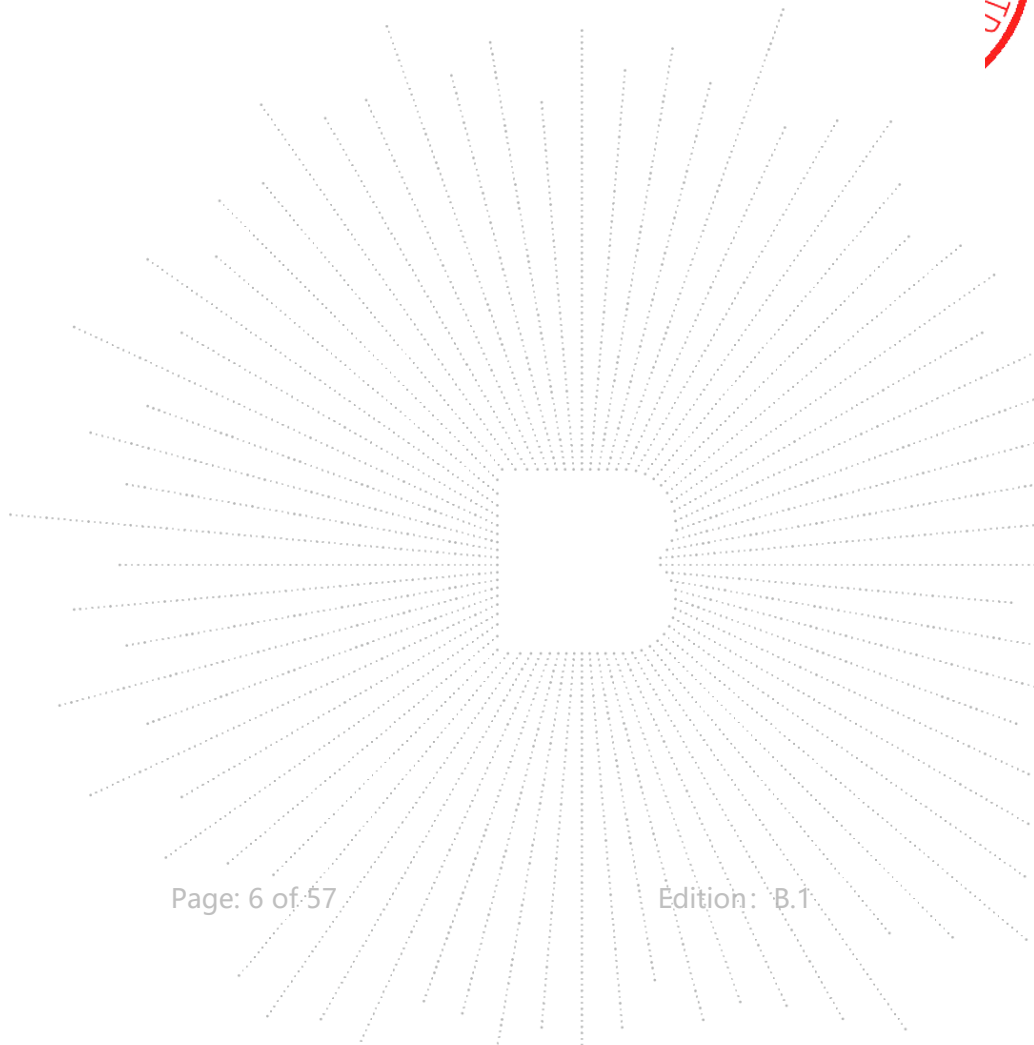

3. Measurement Uncertainty

Where relevant, the following measurement uncertainty levels have been estimated for tests performed on the Product as specified in CISPR 16-4-2. This uncertainty represents an expanded uncertainty expressed at approximately the 95% confidence level using a coverage factor of k=2.

No.	Item	Uncertainty
1	3m Chamber Radiated spurious Emission(30MHz-1GHz)	U=4.3dB
2	3m Chamber Radiated Spurious Emission(9KHz-30MHz)	U=3.7dB
3	3m Chamber Radiated Spurious Emission(1GHz-18GHz)	U=4.5dB
4	3m Chamber Radiated Spurious Emission(18GHz-40GHz)	U=3.34dB
5	Conducted Emission (150kHz-30MHz)	U=3.20dB
6	Conducted Adjacent Channel Power	U=1.38dB
7	Conducted Output Power Uncertainty Above 1G	U=1.576dB
8	Conducted Output Power Uncertainty Below 1G	U=1.28dB
9	Humidity Uncertainty	U=5.3%
10	Temperature Uncertainty	U=0.59°C

4. Product Information And Test Setup

4.1 Product Information

Model/Type reference:	CDW-UVC7300-11(S9)
Model differences:	N/A
Hardware Version:	V1.0
Software Version:	V1.0.1
Operation Frequency:	Wi-Sun: 902.2MHz -927.8MHz
Type of Modulation:	Wi-Sun: FSK
Data rate:	Wi-Sun: 50kbps
Number Of Channel	Wi-Sun: 129CH
Antenna installation:	FPC antenna Antenna 501013894: 0 dBi Antenna 501013895: 2.2 dBi;
Antenna Gain:	Remark: <input checked="" type="checkbox"/> The antenna gain of the product comes from the antenna report provided by the customer, and the test data is affected by the customer information. <input type="checkbox"/> The antenna gain of the product is provided by the customer, and the test data is affected by the customer information.
Ratings:	DC 3.3V

Cable of Product

No.	Cable Type	Quantity	Provider	Length (m)	Shielded	Note
1	--	--	Applicant	---	Yes/No	With a ferrite ring in mid Detachable
2	--	--	BCTC	--	Yes/No	--

4.2 Test Setup Configuration

See test photographs attached in *EUT TEST SETUP PHOTOGRAPHS* for the actual connections between Product and support equipment.

Conducted Emission:

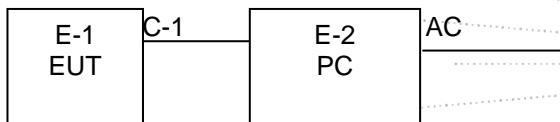

Radiated Spurious Emission

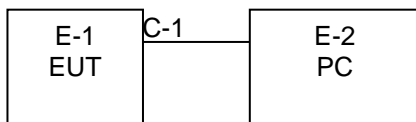

4.3 Support Equipment

No.	Device Type	Brand	Model	Series No.	Note
E-1	Wi-sun module	N/A	CDW-UVC7300-11(S9)	N/A	EUT
E-2	PC	N/A	Thinkpad S2	N/A	Auxiliary

Item	Shielded Type	Ferrite Core	Length	Note
C-1	N/A	N/A	0.5M	USB cable unshielded

Notes:

1. All the equipment/cables were placed in the worst-case configuration to maximize the emission during the test.
2. Grounding was established in accordance with the manufacturer's requirements and conditions for the intended use.

BCTC
 3C
 PPR
 Report

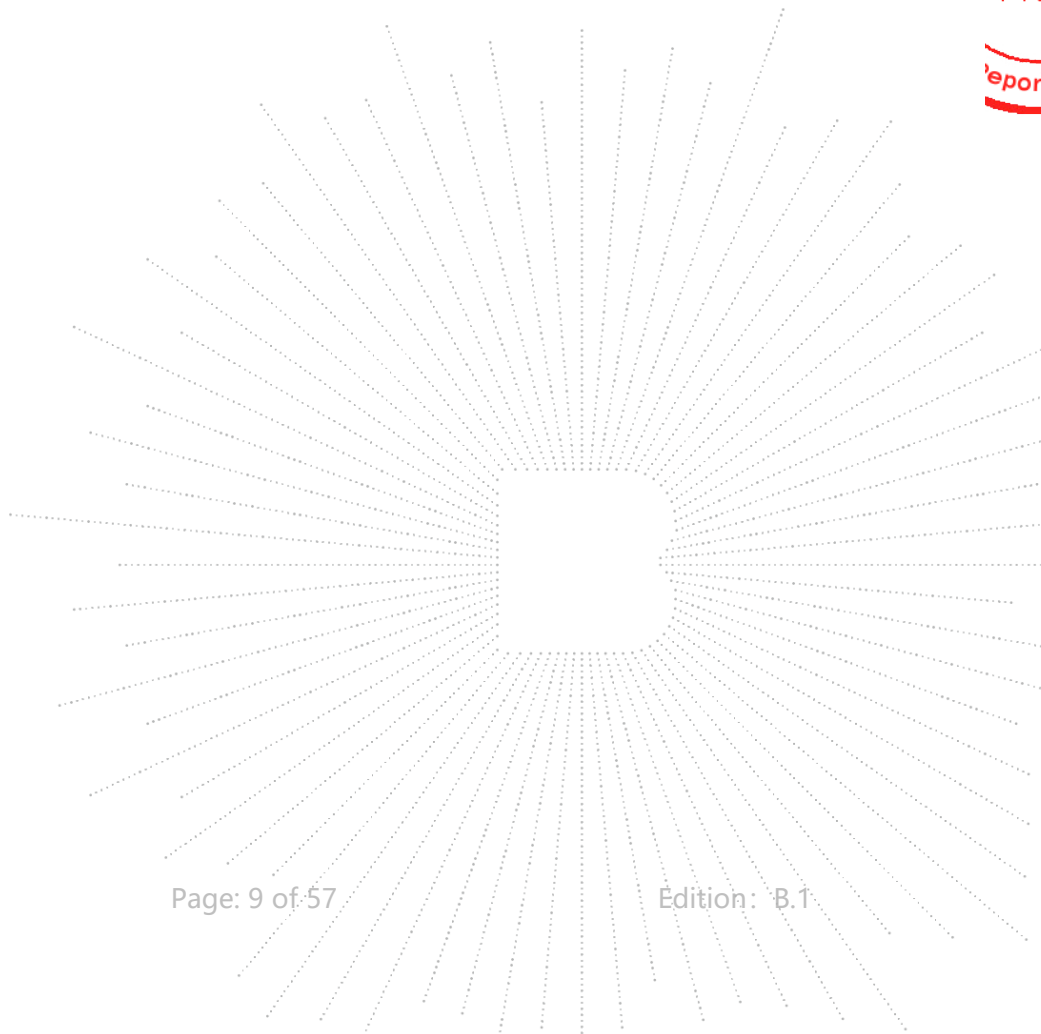

4.4 Channel List

CH	Frequency (MHz)	CH	Frequency (MHz)	CH	Frequency (MHz)
1	902.2	2	902.4	3	902.6
4	902.8	5	903.0	6	903.2
7	903.4	8	903.6	9	903.8
10	904.0	11	904.2	12	904.4
13	904.6	14	904.8	15	905.0
16	905.2	17	905.4	18	905.6
19	905.8	20	906.0	21	906.2
22	906.4	23	906.6	24	906.8
25	907.0	26	907.2	27	907.4
28	907.6	29	907.8	30	908.0
31	908.2	32	908.4	33	908.6
34	908.8	35	909.0	36	909.2
37	909.4	38	909.6	39	909.8
40	910.0	41	910.2	42	910.4
43	910.6	44	910.8	45	911.0
46	911.2	47	911.4	48	911.6
49	911.8	50	912.0	51	912.2
52	912.4	53	912.6	54	912.8
55	913.0	56	913.2	57	913.4
58	913.6	59	913.8	60	914.0
61	914.2	62	914.4	63	914.6
64	914.8	65	915.0	66	915.2
67	915.4	68	915.6	69	915.8
70	916.0	71	916.2	72	916.4
73	916.6	74	916.8	75	917.0
76	917.2	77	917.4	78	917.6
79	917.8	80	918.0	81	918.2
82	918.4	83	918.6	84	918.8
85	919.0	86	919.2	87	919.4
88	919.6	89	919.8	90	920.0
91	920.2	92	920.4	93	920.6
94	920.8	95	921.0	96	921.2
97	921.4	98	921.6	99	921.8
100	922.0	101	922.2	102	922.4
103	922.6	104	922.8	105	923.0
106	923.2	107	923.4	108	923.6
109	923.8	110	924.0	111	924.2
112	924.4	113	924.6	114	924.8
115	925.0	116	925.2	117	925.4
118	925.6	119	925.8	120	926.0
121	926.2	122	926.4	123	926.6
124	926.8	125	927.0	126	927.2
127	927.4	128	927.6	129	927.8

4.5 Test Mode

To investigate the maximum EMI emission characteristics generates from EUT, the test system was pre-scanning tested base on the consideration of following EUT operation mode or test configuration mode which possible have effect on EMI emission level. Each of these EUT operation mode(s) or test configuration mode(s) mentioned above was evaluated respectively.

Test Mode	Low channel	Middle channel	High channel
1	902.2MHz	915MHz	927.8MHz
2	Hopping Mode		
3	Transmitting (Conducted emission & Radiated emission)		

Note:

(1) The measurements are performed at the highest, middle, lowest available channels.

4.6 Table Of Parameters Of Text Software Setting

During testing channel & power controlling software provided by the customer was used to control the operating channel as well as the output power level. The RF output power selection is for the setting of RF output power expected by the customer and is going to be fixed on the firmware of the final end product power parameters

Test software Version	sscom5.13.1		
Frequency	902.2MHz	915MHz	927.8MHz
Parameters	DEF	DEF	DEF

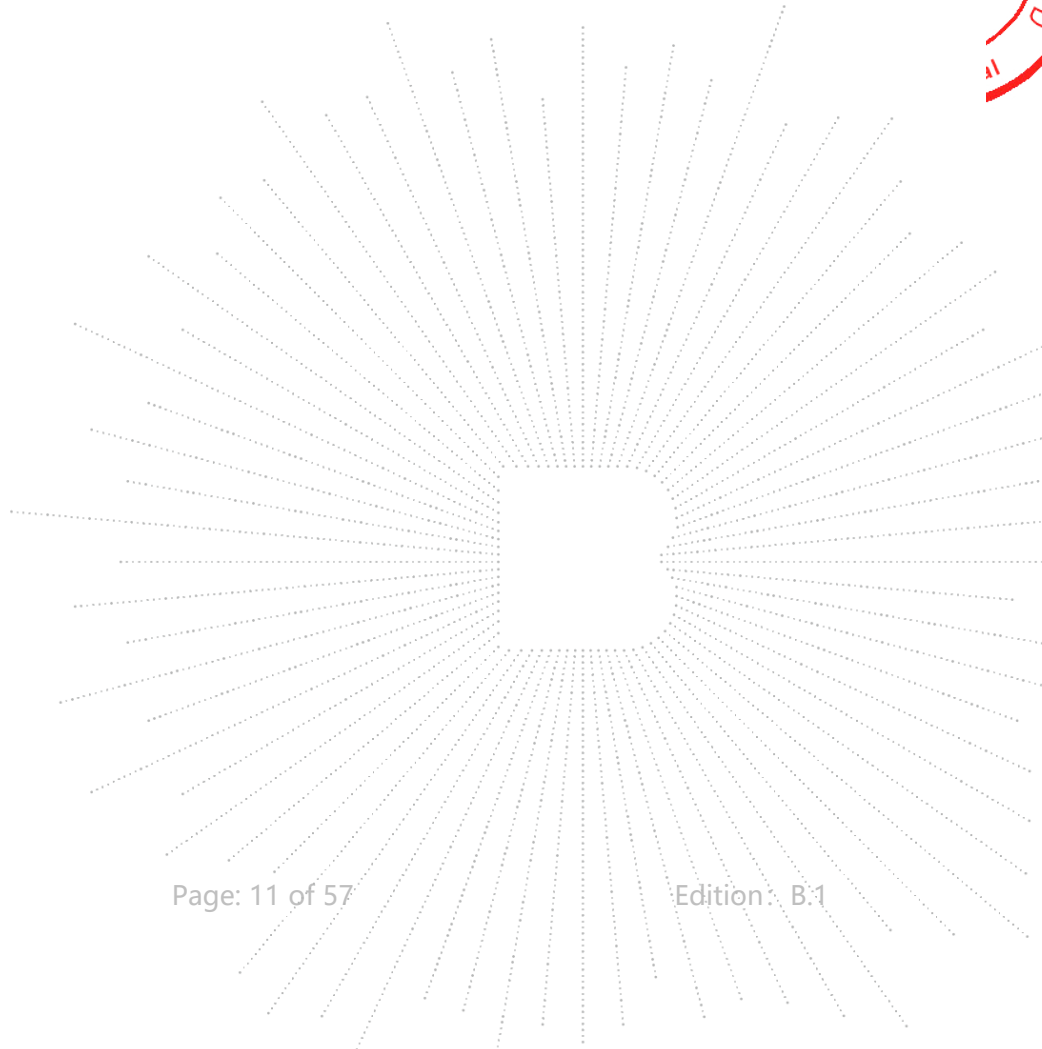

5. Test Facility And Test Instrument Used

5.1 Test Facility

All measurement facilities used to collect the measurement data are located at Shenzhen BCTC Testing Co., Ltd. Address: 1-2/F., Building B, Pengzhou Industrial Park, No.158, Fuyuan 1st Road, Zhancheng, Fuhai Subdistrict, Bao'an District, Shenzhen, Guangdong, China. The site and apparatus are constructed in conformance with the requirements of ANSI C63.4 and CISPR 16-1-1 other equivalent standards.

FCC Test Firm Registration Number: 712850

A2LA certificate registration number is: CN1212

ISED Registered No.: 23583

ISED CAB identifier: CN0017

5.2 Test Instrument Used

Conducted Emissions Test					
Equipment	Manufacturer	Model#	Serial#	Last Cal.	Next Cal.
Receiver	R&S	ESR3	102075	May 15, 2023	May 14, 2024
LISN	R&S	ENV216	101375	May 15, 2023	May 14, 2024
Software	Frad	EZ-EMC	EMC-CON 3A1	\	\
Attenuator	\	10dB DC-6GHz	1650	May 15, 2023	May 14, 2024

RF Conducted Test					
Equipment	Manufacturer	Model#	Serial#	Last Cal.	Next Cal.
Power Meter	Keysight	E4419	\	May 15, 2023	May 14, 2024
Power Sensor (AV)	Keysight	E9300A	\	May 15, 2023	May 14, 2024
Signal Analyzer20kHz-26.5GHz	Keysight	N9020A	MY49100060	May 15, 2023	May 14, 2024
Spectrum Analyzer9kHz-40GHz	R&S	FSP40	100363	May 15, 2023	May 14, 2024

Radiated Emissions Test (966 Chamber01)					
Equipment	Manufacturer	Model#	Serial#	Last Cal.	Next Cal.
966 chamber	ChengYu	966 Room	966	May 15, 2023	May 14, 2026
Receiver	R&S	ESR3	102075	May 15, 2023	May 14, 2024
Receiver	R&S	ESRP	101154	May 15, 2023	May 14, 2024
Amplifier	Schwarzbeck	BBV9744	9744-0037	May 15, 2023	May 14, 2024
TRILOG Broadband Antenna	Schwarzbeck	VULB9163	942	May 29, 2023	May 28, 2024
Loop Antenna(9KHz -30MHz)	Schwarzbeck	FMZB1519B	00014	May 31, 2023	May 30, 2024
Amplifier	SKET	LAPA_01G18 G-45dB	\	May 15, 2023	May 14, 2024
Horn Antenna	Schwarzbeck	BBHA9120D	1541	May 31, 2023	May 30, 2024
Amplifier(18G Hz-40GHz)	MITEQ	TTA1840-35-HG	2034381	May 15, 2023	May 14, 2024
Horn Antenna(18G Hz-40GHz)	Schwarzbeck	BBHA9170	00822	May 31, 2023	May 30, 2024
Spectrum Analyzer9kHz-40GHz	R&S	FSP40	100363	May 15, 2023	May 14, 2024
Software	Frad	EZ-EMC	FA-03A2 RE	\	\

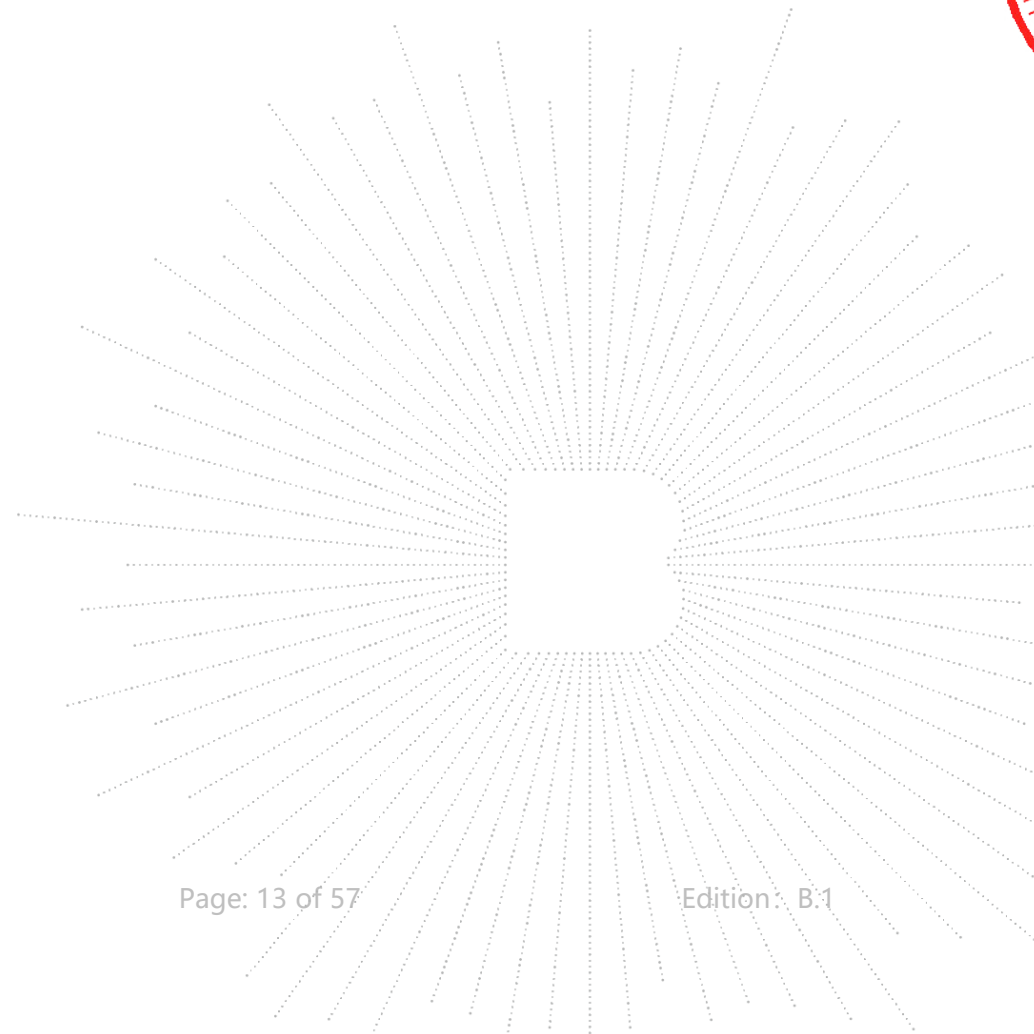
6. Conducted Emissions

6.1 Block Diagram Of Test Setup

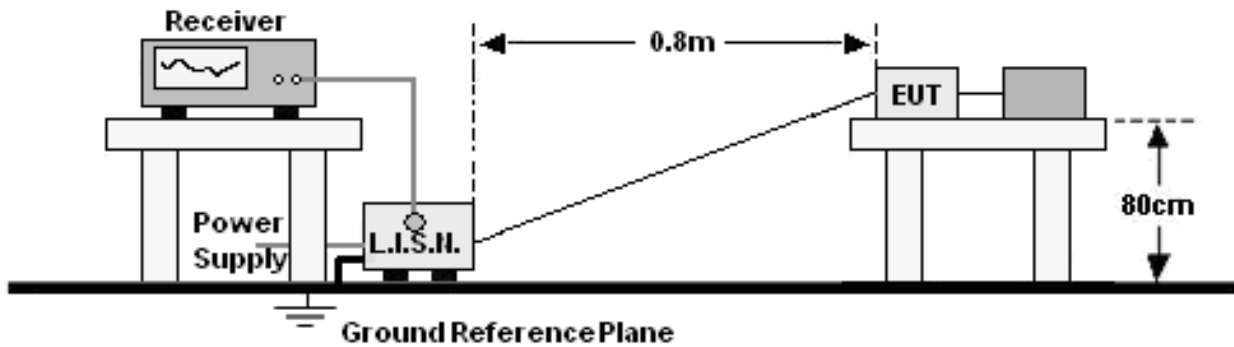

6.2 Limit

Frequency (MHz)	Limit (dBuV)	
	Quas-peak	Average
0.15 -0.5	66 - 56 *	56 - 46 *
0.50 -5.0	56.00	46.00
5.0 -30.0	60.00	50.00

Notes:
 1. *Decreasing linearly with logarithm of frequency.
 2. The lower limit shall apply at the transition frequencies.

6.3 Test procedure

Receiver Parameters	Setting
Attenuation	10 dB
Start Frequency	0.15 MHz
Stop Frequency	30 MHz
IF Bandwidth	9 kHz

- The Product was placed on a nonconductive table 0.8 m above the horizontal ground reference plane, and 0.4 m from the vertical ground reference plane, and connected to the main through Line Impedance Stability Network (L.I.S.N).
- The RBW of the receiver was set at 9 kHz in 150 kHz ~ 30MHz with Peak and AVG detector in Max Hold mode. Run the receiver's pre-scan to record the maximum disturbance generated from Product in all power lines in the full band.
- For each frequency whose maximum record was higher or close to limit, measure its QP and AVG values and record.

6.4 EUT operating Conditions

The EUT was configured for testing in a typical fashion (as a customer would normally use it). The EUT has been programmed to continuously transmit during test. This operating condition was tested and used to collect the included data.

6.5 Test Result

Antenna 501013894

Temperature:	26 °C	Relative Humidity:	54%
Pressure:	101KPa	Phase :	L
Test Mode:	Mode 3	Test Voltage :	AC 120V/60Hz

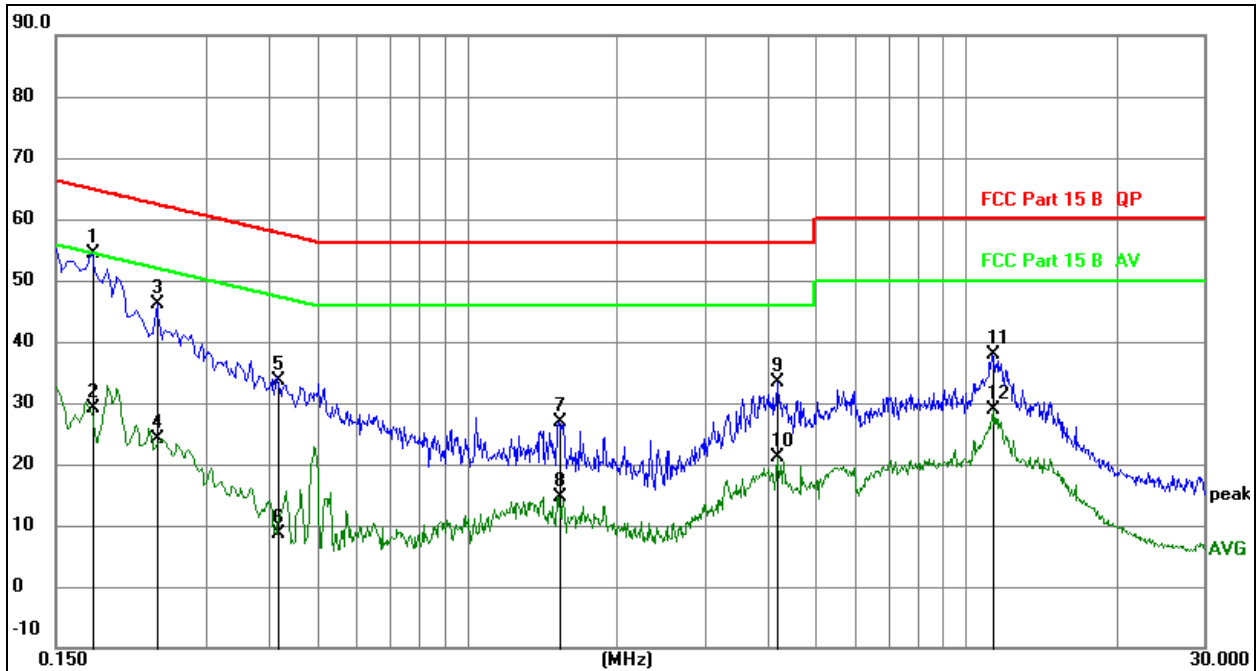

Remark:

1. All readings are Quasi-Peak and Average values.
2. Factor = Insertion Loss + Cable Loss.
3. Measurement = Reading Level + Correct Factor
4. Over = Measurement - Limit

No.	Mk.	Freq. MHz	Reading Level	Correct Factor dB	Measure- ment dBuV	Limit dBuV	Over dB	Detector
1	*	0.1770	34.65	19.78	54.43	64.63	-10.20	QP
2		0.1770	9.36	19.78	29.14	54.63	-25.49	AVG
3		0.2400	26.27	19.83	46.10	62.10	-16.00	QP
4		0.2400	4.27	19.83	24.10	52.10	-28.00	AVG
5		0.4171	13.90	19.84	33.74	57.51	-23.77	QP
6		0.4171	-11.14	19.84	8.70	47.51	-38.81	AVG
7		1.5315	6.94	19.95	26.89	56.00	-29.11	QP
8		1.5315	-5.27	19.95	14.68	46.00	-31.32	AVG
9		4.1820	12.65	20.62	33.27	56.00	-22.73	QP
10		4.1820	0.52	20.62	21.14	46.00	-24.86	AVG
11		11.3010	17.99	19.88	37.87	60.00	-22.13	QP
12		11.3010	8.88	19.88	28.76	50.00	-21.24	AVG

Temperature:	26 °C	Relative Humidity:	54%
Pressure:	101KPa	Phase :	N
Test Mode:	Mode 3	Test Voltage :	AC 120V/60Hz

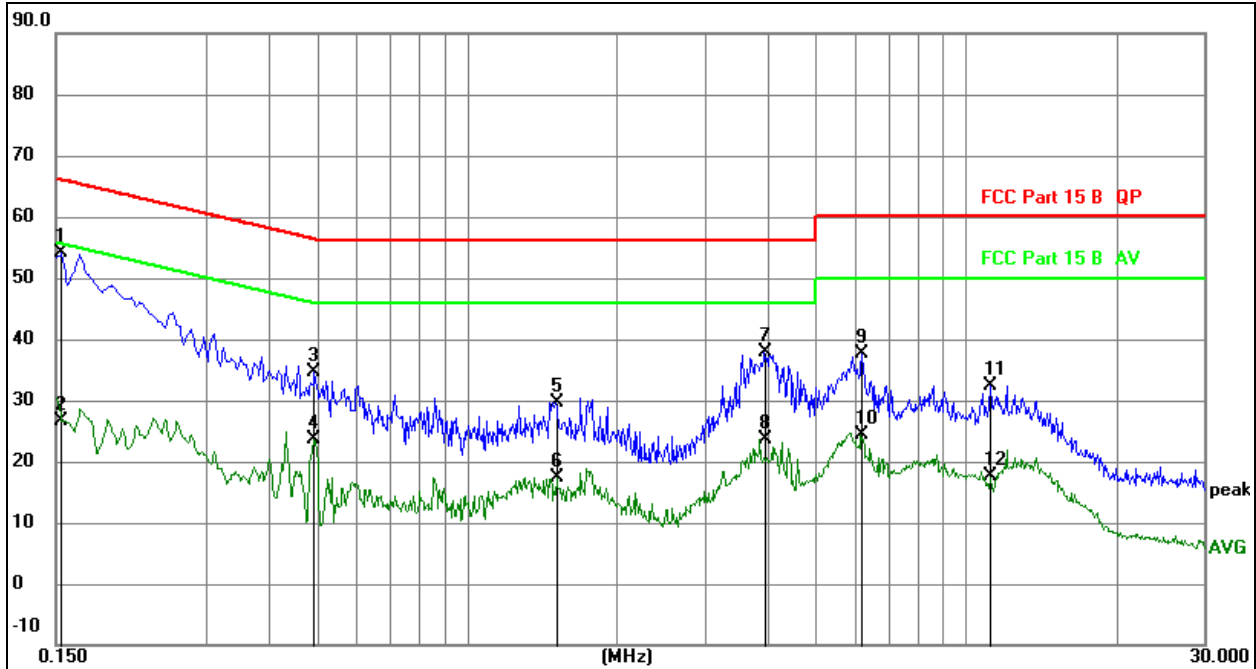

Remark:

1. All readings are Quasi-Peak and Average values.
2. Factor = Insertion Loss + Cable Loss.
3. Measurement = Reading Level + Correct Factor
4. Over = Measurement - Limit

No.	Mk.	Freq. MHz	Reading Level	Correct Factor dB	Measure- ment dBuV	Limit dBuV	Over dB	Detector
1	*	0.1539	34.47	19.74	54.21	65.79	-11.58	QP
2		0.1539	6.85	19.74	26.59	55.79	-29.20	AVG
3		0.4941	14.79	19.84	34.63	56.10	-21.47	QP
4		0.4941	3.80	19.84	23.64	46.10	-22.46	AVG
5		1.5033	9.78	19.95	29.73	56.00	-26.27	QP
6		1.5033	-2.46	19.95	17.49	46.00	-28.51	AVG
7		3.9430	17.21	20.64	37.85	56.00	-18.15	QP
8		3.9430	2.87	20.64	23.51	46.00	-22.49	AVG
9		6.1860	17.44	20.15	37.59	60.00	-22.41	QP
10		6.1860	4.11	20.15	24.26	50.00	-25.74	AVG
11		11.1977	12.42	19.88	32.30	60.00	-27.70	QP
12		11.1977	-2.36	19.88	17.52	50.00	-32.48	AVG

Antenna 501013895

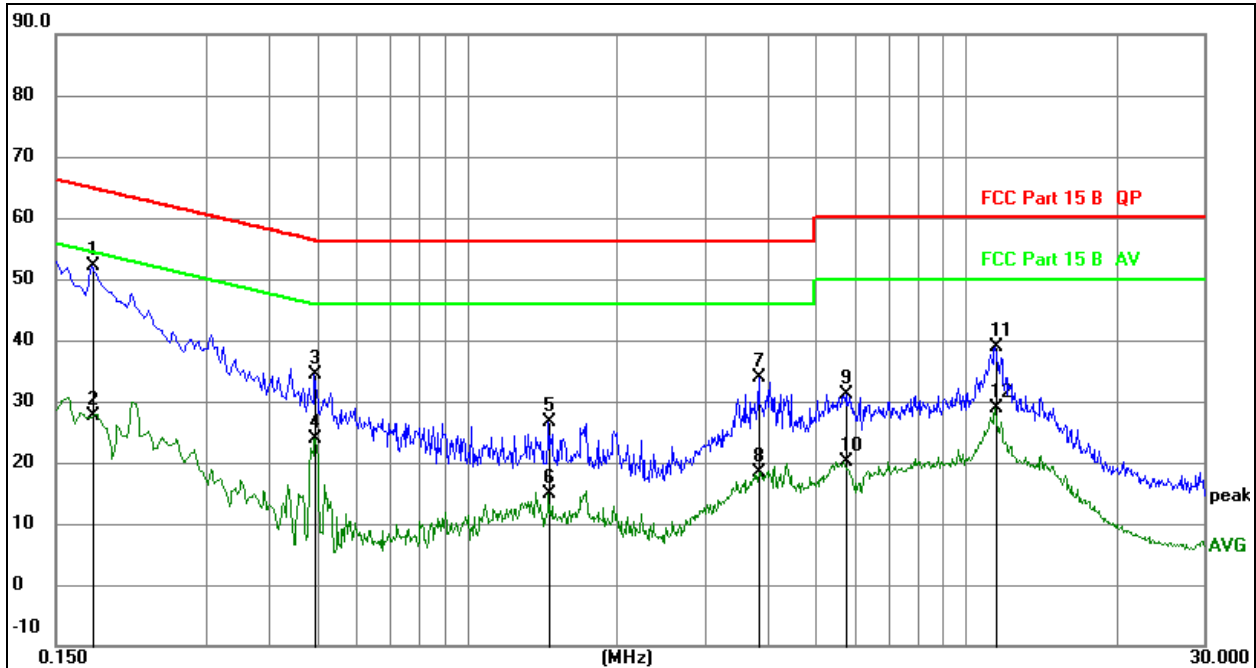
Temperature:	26 °C	Relative Humidity:	54%
Pressure:	101KPa	Phase :	L
Test Mode:	Mode 3	Test Voltage :	AC 120V/60Hz

Remark:

1. All readings are Quasi-Peak and Average values.
2. Factor = Insertion Loss + Cable Loss.
3. Measurement = Reading Level + Correct Factor
4. Over = Measurement - Limit

No.	Mk.	Freq. MHz	Reading Level	Correct Factor dB	Measure- ment dBuV	Limit dBuV	Over dB	Detector
1	*	0.1770	32.42	19.78	52.20	64.63	-12.43	QP
2		0.1770	7.89	19.78	27.67	54.63	-26.96	AVG
3		0.4965	14.43	19.84	34.27	56.06	-21.79	QP
4		0.4965	4.01	19.84	23.85	46.06	-22.21	AVG
5		1.4595	6.59	19.95	26.54	56.00	-29.46	QP
6		1.4595	-5.05	19.95	14.90	46.00	-31.10	AVG
7		3.8445	13.21	20.60	33.81	56.00	-22.19	QP
8		3.8445	-2.22	20.60	18.38	46.00	-27.62	AVG
9		5.7525	10.91	20.25	31.16	60.00	-28.84	QP
10		5.7525	-0.01	20.25	20.24	50.00	-29.76	AVG
11		11.4540	18.94	19.88	38.82	60.00	-21.18	QP
12		11.4540	9.01	19.88	28.89	50.00	-21.11	AVG

Temperature:	26 °C	Relative Humidity:	54%
Pressure:	101KPa	Phase :	N
Test Mode:	Mode 3	Test Voltage :	AC 120V/60Hz

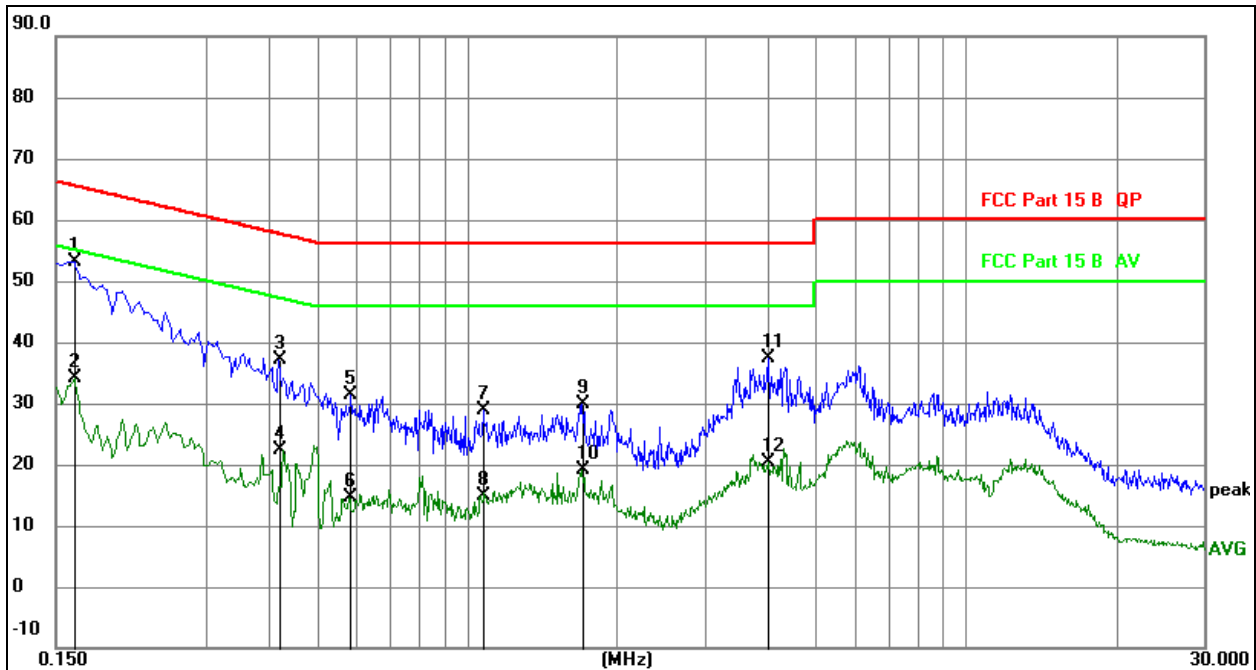
Remark:

1. All readings are Quasi-Peak and Average values.
2. Factor = Insertion Loss + Cable Loss.
3. Measurement = Reading Level + Correct Factor
4. Over = Measurement - Limit

No.	Mk.	Freq. MHz	Reading Level	Correct Factor dB	Measure- ment dBuV	Limit dBuV	Over dB	Detector
1	*	0.1633	33.39	19.76	53.15	65.29	-12.14	QP
2		0.1633	14.30	19.76	34.06	55.29	-21.23	AVG
3		0.4193	17.17	19.84	37.01	57.46	-20.45	QP
4		0.4193	2.57	19.84	22.41	47.46	-25.05	AVG
5		0.5854	11.56	19.84	31.40	56.00	-24.60	QP
6		0.5854	-5.31	19.84	14.53	46.00	-31.47	AVG
7		1.0766	8.82	19.95	28.77	56.00	-27.23	QP
8		1.0766	-5.16	19.95	14.79	46.00	-31.21	AVG
9		1.6981	9.96	19.95	29.91	56.00	-26.09	QP
10		1.6981	-0.94	19.95	19.01	46.00	-26.99	AVG
11		4.0062	16.67	20.66	37.33	56.00	-18.67	QP
12		4.0062	-0.19	20.66	20.47	46.00	-25.53	AVG

7. Radiated Emissions

7.1 Block Diagram Of Test Setup

(A) Radiated Emission Test-Up Frequency Below 30MHz

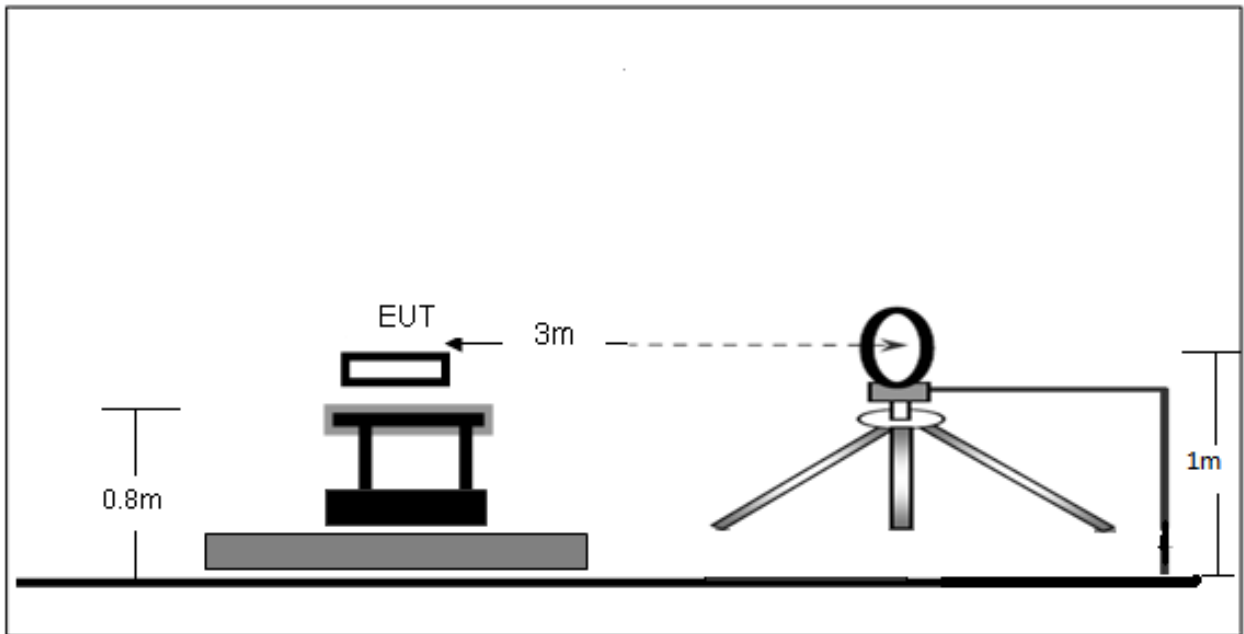

(B) Radiated Emission Test-Up Frequency 30MHz~1GHz

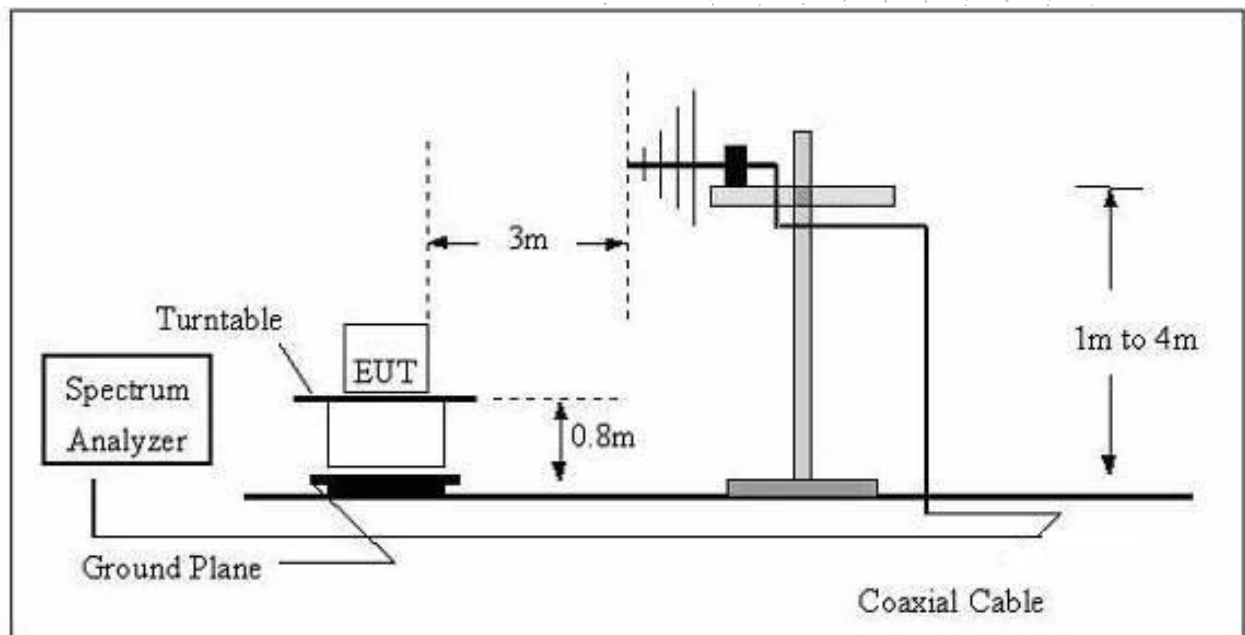

(C) Radiated Emission Test-Up Frequency Above 1GHz

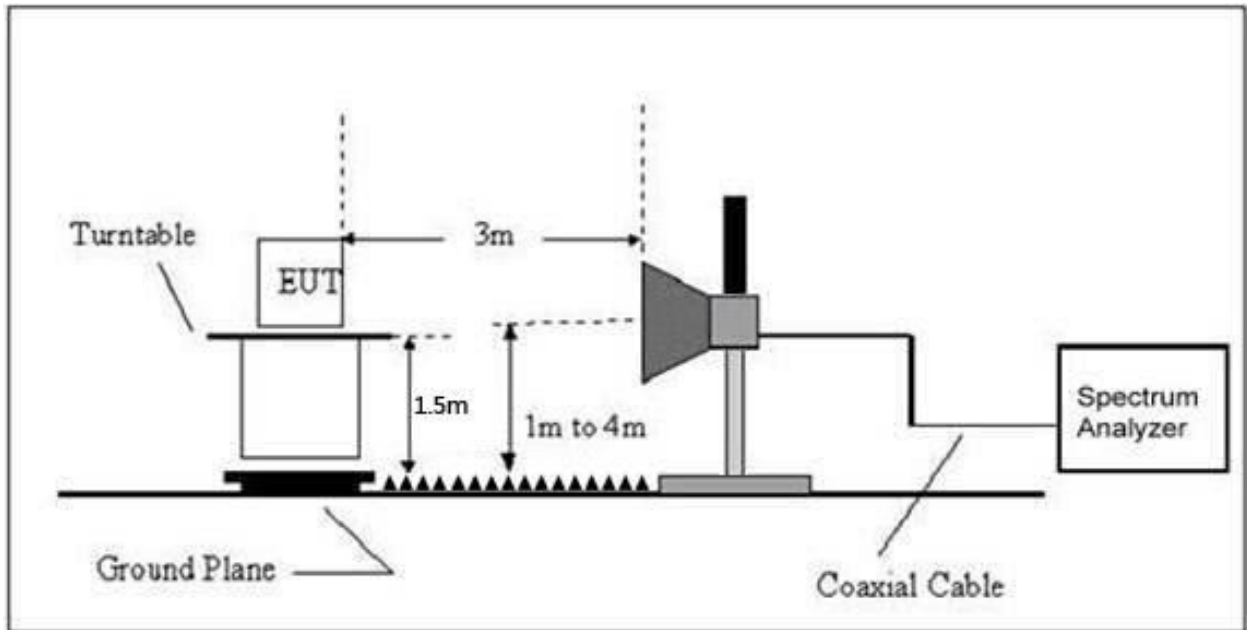

7.2 Limit

20dBc in any 100 kHz bandwidth outside the operating frequency band. In case the emission fall within the restricted band specified on 15.205(a), then the 15.209(a) limit in the table below has to be followed.

Frequency (MHz)	Field Strength uV/m	Distance (m)	Field Strength Limit at 3m Distance	
			uV/m	dBuV/m
0.009 ~ 0.490	2400/F(kHz)	300	10000 * 2400/F(kHz)	$20\log^{(2400/F(kHz))} + 80$
0.490 ~ 1.705	24000/F(kHz)	30	100 * 24000/F(kHz)	$20\log^{(24000/F(kHz))} + 40$
1.705 ~ 30	30	30	100 * 30	$20\log^{(30)} + 40$
30 ~ 88	100	3	100	$20\log^{(100)}$
88 ~ 216	150	3	150	$20\log^{(150)}$
216 ~ 960	200	3	200	$20\log^{(200)}$
Above 960	500	3	500	$20\log^{(500)}$

Limits Of Radiated Emission Measurement (Above 1000MHz)

Frequency (MHz)	Limit (dBuV/m) (at 3M)	
	Peak	Average
Above 1000	74	54

Notes:

- (1) The limit for radiated test was performed according to FCC PART 15C.
- (2) The tighter limit applies at the band edges.
- (3) Emission level (dBuV/m) = 20log Emission level (uV/m).

Frequency Range Of Radiated Measurement

(a) For an intentional radiator the spectrum shall be investigated from the lowest radio frequency signal generated in the device, without going below 9 kHz, up to at least the frequency shown in this paragraph:

- (1) If the intentional radiator operates below 10 GHz: to the tenth harmonic of the highest fundamental frequency or to 40 GHz, whichever is lower.
- (2) If the intentional radiator operates at or above 10 GHz and below 30 GHz: to the fifth harmonic of the highest fundamental frequency or to 100 GHz, whichever is lower.
- (3) If the intentional radiator operates at or above 30 GHz: to the fifth harmonic of the highest fundamental frequency or to 200 GHz, whichever is lower, unless specified otherwise elsewhere in the rules.
- (4) If the intentional radiator operates at or above 95 GHz: To the third harmonic of the highest fundamental frequency or to 750 GHz, whichever is lower, unless specified otherwise elsewhere in the rules.
- (5) If the intentional radiator contains a digital device, regardless of whether this digital device controls the functions of the intentional radiator or the digital device is used for additional control or function purposes other than to enable the operation of the intentional radiator, the frequency range shall be investigated up to the range specified in paragraphs (a) (1)through (4) of this section or the range applicable to the digital device, as shown in paragraph (b)(1) of this section, whichever is the higher frequency range of investigation.

7.3 Test procedure

Receiver Parameter	Setting
Attenuation	Auto
9kHz~150kHz	RBW 200Hz for QP
150kHz~30MHz	RBW 9kHz for QP
30MHz~1000MHz	RBW 120kHz for QP

Spectrum Parameter	Setting
1-25GHz	RBW 1 MHz /VBW 1 MHz for Peak, RBW 1 MHz / VBW 10Hz for Average

Below 1GHz test procedure as below:

- a. The EUT was placed on the top of a rotating table 0.8 meters above the ground at a 3 meter semi-anechoic chamber. The table was rotated 360 degrees to determine the position of the highest radiation.
- b. The EUT was set 3 meters away from the interference-receiving antenna, which was mounted on the top of a variable-height antenna tower.
- c. The antenna height is varied from one meter to four meters above the ground to determine the maximum value of the field strength. Both horizontal and vertical polarizations of the antenna are set to make the measurement.
- d. For each suspected emission, the EUT was arranged to its worst case and then the antenna was tuned to heights from 1 meter to 4 meters (for the test frequency of below 30MHz, the antenna was tuned to heights 1 meter) and the rotatable table was turned from 0 degrees to 360 degrees to find the maximum reading.
- e. The test-receiver system was set to Peak Detect Function and Specified Bandwidth with Maximum Hold Mode.
- f. If the emission level of the EUT in peak mode was 10dB lower than the limit specified, then testing could be stopped and the peak values of the EUT would be reported. Otherwise the emissions that did not have 10dB margin would be re-tested one by one using peak, quasi-peak or average method as specified and then reported in a data sheet.

Above 1GHz test procedure as below:

- a. The EUT was placed on the top of a rotating table 1.5 meters above the ground at a 3 meter chamber. The table was rotated 360 degrees to determine the position of the highest radiation.

BCTC
 BCTC
 PPR
 Report

- b. The EUT was set 3 meters away from the interference-receiving antenna, which was mounted on the top of a variable-height antenna tower.
- c. The antenna height is varied from one meter to four meters above the ground to determine the maximum value of the field strength. Both horizontal and vertical polarizations of the antenna are set to make the measurement.
- d. For each suspected emission, the EUT was arranged to its worst case and then the antenna was tuned to heights from 1 meter to 4 meters and the rota table was turned from 0 degrees to 360 degrees to find the maximum reading.
- e. The test-receiver system was set to Peak Detect Function and Specified Bandwidth with Maximum Hold Mode.
- f. If the emission level of the EUT in peak mode was 10dB lower than the limit specified, then testing could be stopped and the peak values of the EUT would be reported. Otherwise the emissions that did not have 10dB margin would be re-tested one by one using peak, quasi-peak or average method as specified and then reported in a data sheet.
- g. Test the EUT in the lowest channel, the middle channel, the Highest channel.
- Note:
Both horizontal and vertical antenna polarities were tested and performed pretest to three orthogonal axis. The worst case emissions were reported.

7.4 EUT operating Conditions

The EUT was configured for testing in a typical fashion (as a customer would normally use it). The EUT has been programmed to continuously transmit during test. This operating condition was tested and used to collect the included data.

7.5 Test Result

Below 30MHz

Temperature:	26 °C	Relative Humidity:	54%
Pressure:	101KPa	Test Voltage :	DC 5V from PC
Test Mode:	Mode 3		

Freq. (MHz)	Reading (dBuV/m)	Limit (dBuV/m)	Margin (dB)	State P/F
--	--	--	--	PASS
--	--	--	--	PASS

Note:

The amplitude of spurious emissions which are attenuated by more than 20dB below the permissible value has no need to be reported.

Distance extrapolation factor = $40 \log(\text{specific distance}/\text{test distance})(\text{dB})$;

Limit line = specific limits(dBuV) + distance extrapolation factor.

Antenna 501013894
 Between 30MHz – 1GHz

Temperature:	26 °C	Relative Humidity:	54%
Pressure:	101KPa	Phase :	Horizontal
Test Mode:	Mode 3	Test Voltage:	DC 5V from PC

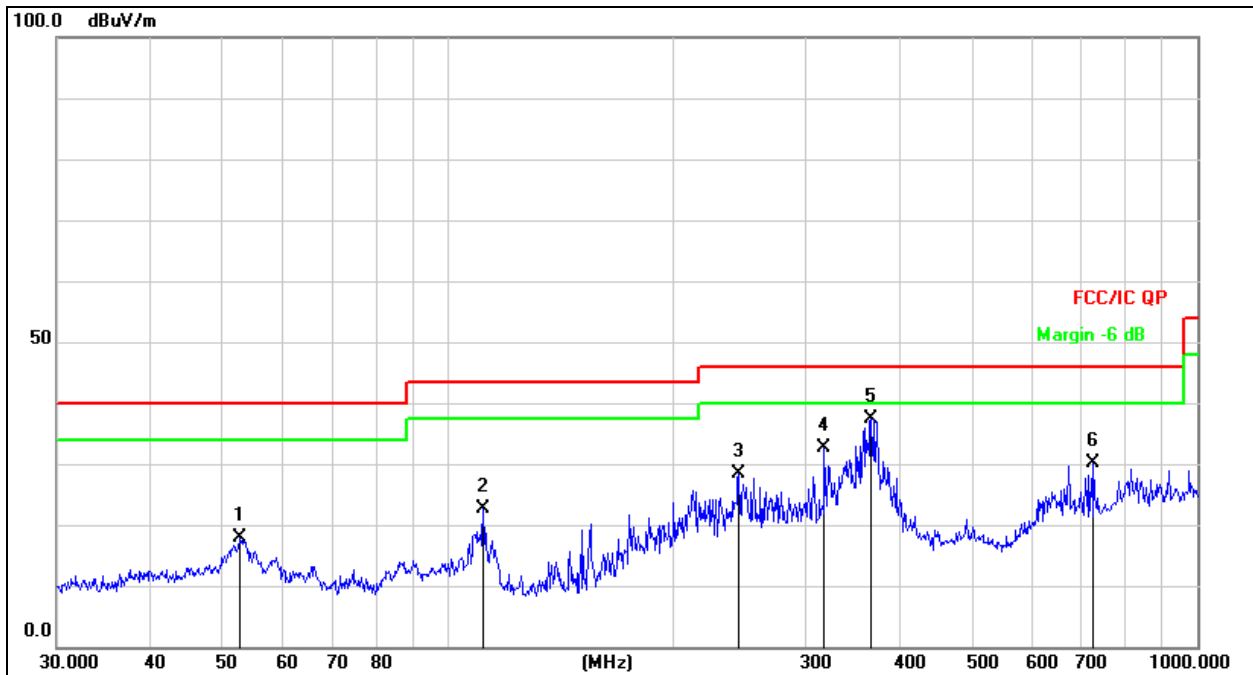
Remark:

1. Factor = Antenna Factor + Cable Loss – Pre-amplifier.
2. Measurement = Reading Level + Correct Factor
3. Over = Measurement - Limit

No.	Mk.	Freq. MHz	Reading Level dBuV	Correct Factor dB	Measure- ment dBuV/m	Limit dB/m	Over dB	Detector
1		52.7600	32.03	-14.27	17.76	40.00	-22.24	QP
2		111.3468	39.38	-16.72	22.66	43.50	-20.84	QP
3		244.2321	42.75	-14.45	28.30	46.00	-17.70	QP
4		317.7011	45.19	-12.62	32.57	46.00	-13.43	QP
5	*	366.8231	48.72	-11.26	37.46	46.00	-8.54	QP
6		726.8052	35.39	-5.32	30.07	46.00	-15.93	QP

Temperature:	26 °C	Relative Humidity:	54%
Pressure:	101KPa	Phase :	Vertical
Test Mode:	Mode 3	Test Voltage:	DC 5V from PC

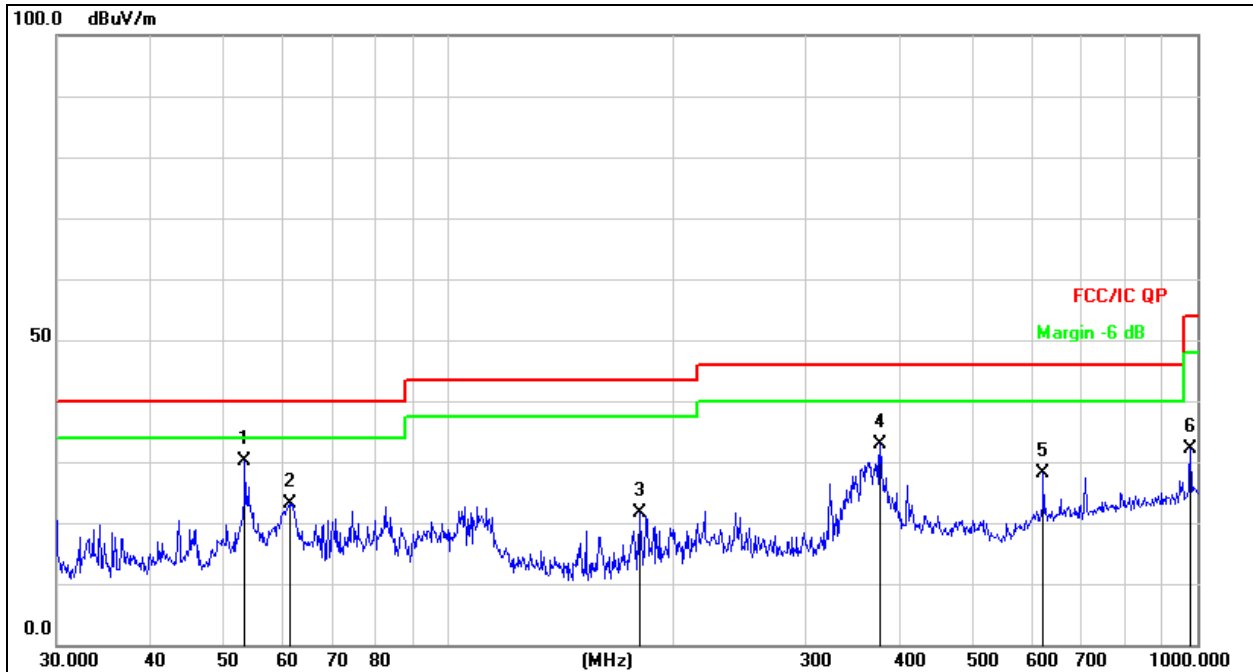

Remark:

- Factor = Antenna Factor + Cable Loss – Pre-amplifier.
- Measurement = Reading Level + Correct Factor
- Over = Measurement - Limit

No.	Mk.	Freq. MHz	Reading Level dBuV	Correct Factor dB	Measure- ment dBuV/m	Limit dB/m	Over dB	Detector
1	*	53.5052	44.45	-14.37	30.08	40.00	-9.92	QP
2		61.3462	38.73	-15.62	23.11	40.00	-16.89	QP
3		180.0165	38.73	-17.20	21.53	43.50	-21.97	QP
4		377.2590	44.04	-11.13	32.91	46.00	-13.09	QP
5		622.8899	34.64	-6.63	28.01	46.00	-17.99	QP
6		979.1803	34.82	-2.60	32.22	54.00	-21.78	QP

Antenna 501013895
 Between 30MHz – 1GHz

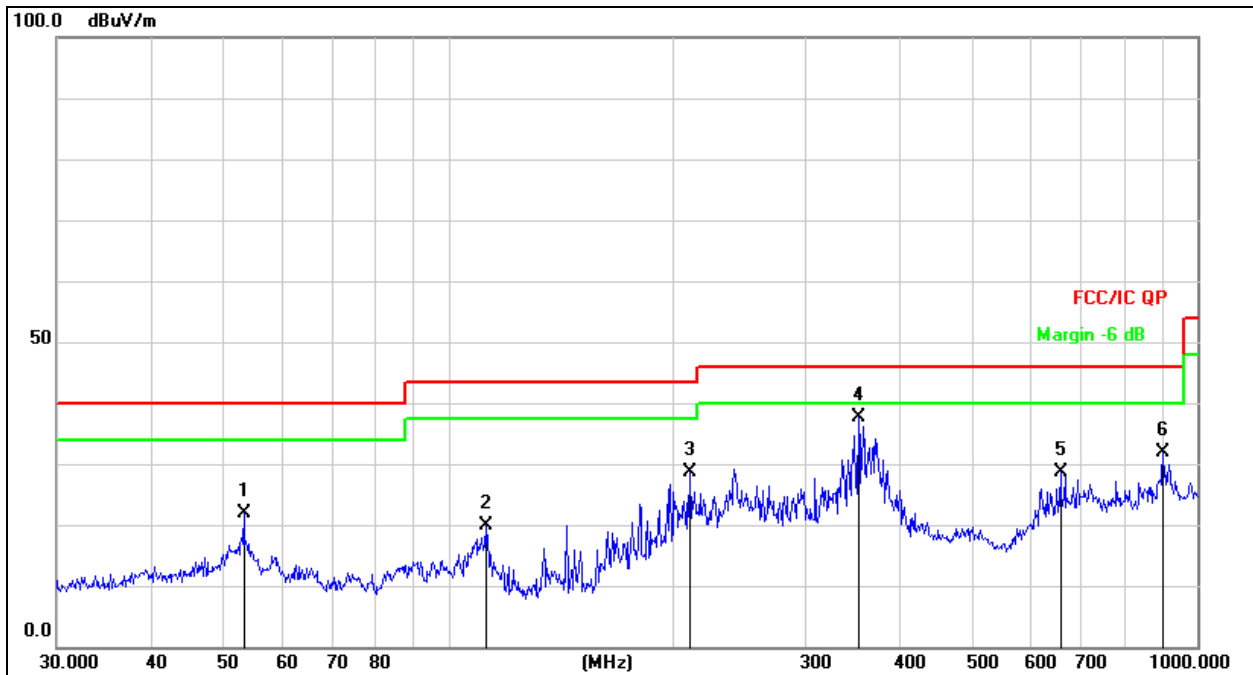
Temperature:	26 °C	Relative Humidity:	54%
Pressure:	101KPa	Phase :	Horizontal
Test Mode:	Mode 3	Test Voltage:	DC 5V from PC



Remark:

1. Factor = Antenna Factor + Cable Loss – Pre-amplifier.
2. Measurement = Reading Level + Correct Factor
3. Over = Measurement - Limit

No.	Mk.	Freq. MHz	Reading Level dBuV	Correct Factor dB	Measure- ment dBuV/m	Limit dB/m	Over dB	Detector
1		53.3179	36.23	-14.35	21.88	40.00	-18.12	QP
2		112.1305	36.74	-16.78	19.96	43.50	-23.54	QP
3		210.0482	44.00	-15.43	28.57	43.50	-14.93	QP
4	*	352.9433	49.00	-11.44	37.56	46.00	-8.44	QP
5		656.5300	34.83	-6.10	28.73	46.00	-17.27	QP
6		900.1474	34.99	-3.12	31.87	46.00	-14.13	QP

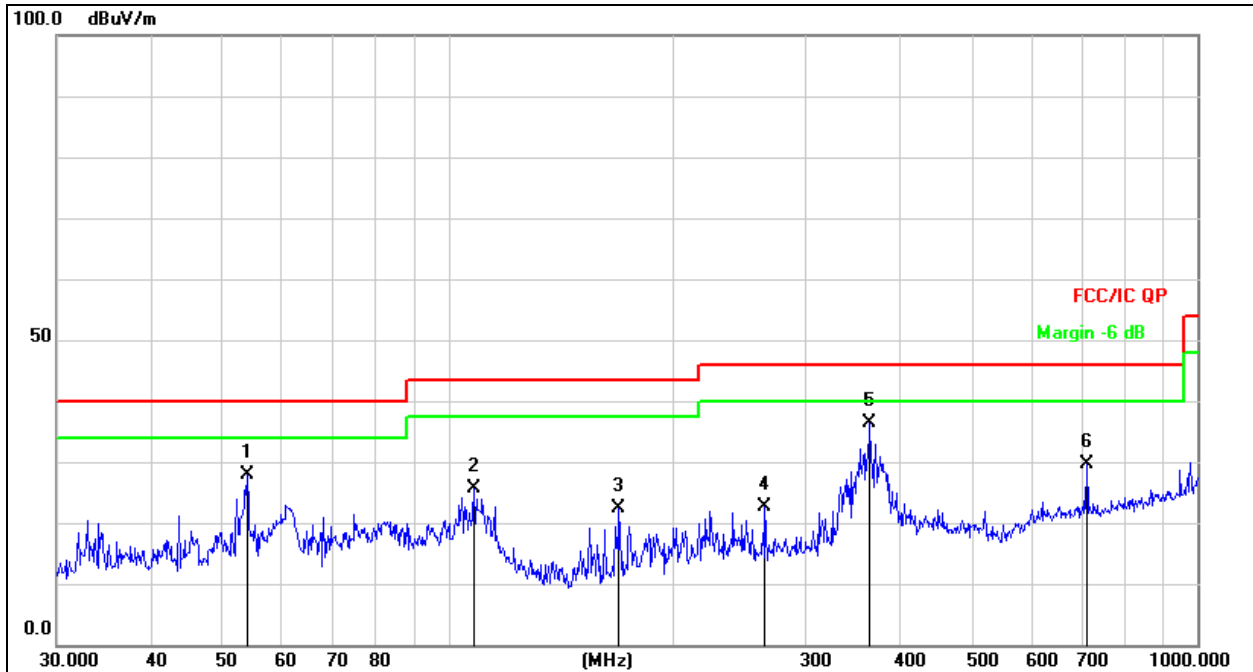

Temperature:	26 °C	Relative Humidity:	54%
Pressure:	101KPa	Phase :	Vertical
Test Mode:	Mode 3	Test Voltage:	DC 5V from PC



Remark:
 1. Factor = Antenna Factor + Cable Loss – Pre-amplifier.
 2. Measurement = Reading Level + Correct Factor
 3. Over = Measurement - Limit

No.	Mk.	Freq. MHz	Reading Level dBuV	Correct Factor dB	Measure- ment dBuV/m	Limit dB/m	Over dB	Detector
1		53.8818	42.25	-14.42	27.83	40.00	-12.17	QP
2		108.2667	42.02	-16.51	25.51	43.50	-17.99	QP
3		169.0054	40.35	-18.02	22.33	43.50	-21.17	QP
4		264.7457	36.64	-13.98	22.66	46.00	-23.34	QP
5	*	365.5391	47.58	-11.28	36.30	46.00	-9.70	QP
6		711.6734	35.20	-5.54	29.66	46.00	-16.34	QP

Antenna 501013894
 Between 1GHz – 25GHz

Polar (H/V)	Fre- quency	Reading Level	Correct Factor	Measure- ment	Limits	Over	Detector Type
	(MHz)	(dBuV/m)	(dB)	(dBuV/m)	(dBuV/m)	(dB)	
FSK Low channel							
V	1804.40	79.08	-27.03	52.05	74.00	-21.95	PK
V	1804.40	69.97	-27.03	42.94	54.00	-11.06	AV
V	2706.60	68.75	-24.48	44.27	74.00	-29.73	PK
V	2706.60	58.77	-24.48	34.29	54.00	-19.71	AV
H	1804.40	76.55	-27.03	49.52	74.00	-24.48	PK
H	1804.40	65.65	-27.03	38.62	54.00	-15.38	AV
H	2706.60	66.88	-24.48	42.40	74.00	-31.60	PK
H	2706.60	59.67	-24.48	35.19	54.00	-18.81	AV
FSK Middle channel							
V	1830.00	76.36	-26.97	49.39	74.00	-24.61	PK
V	1830.00	68.00	-26.97	41.03	54.00	-12.97	AV
V	2745.00	67.42	-24.37	43.05	74.00	-30.95	PK
V	2745.00	59.25	-24.37	34.88	54.00	-19.12	AV
H	1830.00	71.49	-26.97	44.52	74.00	-29.48	PK
H	1830.00	61.97	-26.97	35.00	54.00	-19.00	AV
H	2745.00	64.48	-24.37	40.11	74.00	-33.89	PK
H	2745.00	55.98	-24.37	31.61	54.00	-22.39	AV
FSK High channel							
V	1855.60	78.83	-26.92	51.91	74.00	-22.09	PK
V	1855.60	69.79	-26.92	42.87	54.00	-11.13	AV
V	2783.40	71.88	-24.25	47.63	74.00	-26.37	PK
V	2783.40	61.53	-24.25	37.28	54.00	-16.72	AV
H	1855.60	77.21	-26.92	50.29	74.00	-23.71	PK
H	1855.60	66.70	-26.92	39.78	54.00	-14.22	AV
H	2783.40	68.98	-24.25	44.73	74.00	-29.27	PK
H	2783.40	61.45	-24.25	37.20	54.00	-16.80	AV

Remark:

1. Measurement = Reading Level + Correct Factor,
 Correct Factor = Antenna Factor + Cable Loss – Pre-amplifier,
 Over= Measurement - Limit
2. If peak below the average limit, the average emission was no test.
3. In restricted bands of operation, The spurious emissions below the permissible value more than 20dB
4. The amplitude of spurious emissions which are attenuated by more than 20dB below the permissible value has no need to be reported.

 BCTC
 BCTC
 PPR
 Report

Antenna 501013895
 Between 1GHz – 25GHz

Polar (H/V)	Fre- quency	Reading Level	Correct Factor	Measure- ment	Limits	Over	Detector Type
	(MHz)	(dBuV/m)	(dB)	(dBuV/m)	(dBuV/m)	(dB)	
FSK Low channel							
V	1804.40	80.30	-27.03	53.27	74.00	-20.73	PK
V	1804.40	72.19	-27.03	45.16	54.00	-8.84	AV
V	2706.60	70.78	-24.48	46.30	74.00	-27.70	PK
V	2706.60	61.54	-24.48	37.06	54.00	-16.94	AV
H	1804.40	79.28	-27.03	52.25	74.00	-21.75	PK
H	1804.40	70.20	-27.03	43.17	54.00	-10.83	AV
H	2706.60	67.79	-24.48	43.31	74.00	-30.69	PK
H	2706.60	59.86	-24.48	35.38	54.00	-18.62	AV
FSK Middle channel							
V	1830.00	76.66	-26.97	49.69	74.00	-24.31	PK
V	1830.00	70.12	-26.97	43.15	54.00	-10.85	AV
V	2745.00	68.76	-24.37	44.39	74.00	-29.61	PK
V	2745.00	60.69	-24.37	36.32	54.00	-17.68	AV
H	1830.00	72.20	-26.97	45.23	74.00	-28.77	PK
H	1830.00	61.25	-26.97	34.28	54.00	-19.72	AV
H	2745.00	66.19	-24.37	41.82	74.00	-32.18	PK
H	2745.00	59.09	-24.37	34.72	54.00	-19.28	AV
FSK High channel							
V	1855.60	77.79	-26.92	50.87	74.00	-23.13	PK
V	1855.60	69.01	-26.92	42.09	54.00	-11.91	AV
V	2783.40	71.60	-24.25	47.35	74.00	-26.65	PK
V	2783.40	61.91	-24.25	37.66	54.00	-16.34	AV
H	1855.60	76.32	-26.92	49.40	74.00	-24.60	PK
H	1855.60	66.68	-26.92	39.76	54.00	-14.24	AV
H	2783.40	68.70	-24.25	44.45	74.00	-29.55	PK
H	2783.40	60.20	-24.25	35.95	54.00	-18.05	AV

Remark:

- 1.Measurement = Reading Level + Correct Factor,
Correct Factor = Antenna Factor + Cable Loss – Pre-amplifier,
Over= Measurement - Limit
- 2.If peak below the average limit, the average emission was no test.
3. In restricted bands of operation, The spurious emissions below the permissible value more than 20dB
4. The amplitude of spurious emissions which are attenuated by more than 20dB below the permissible value has no need to be reported.

8. Radiated Band Emission Measurement And Restricted Bands Of Operation

8.1 Block Diagram Of Test Setup

Radiated Emission Test-Up Frequency Above 1GHz

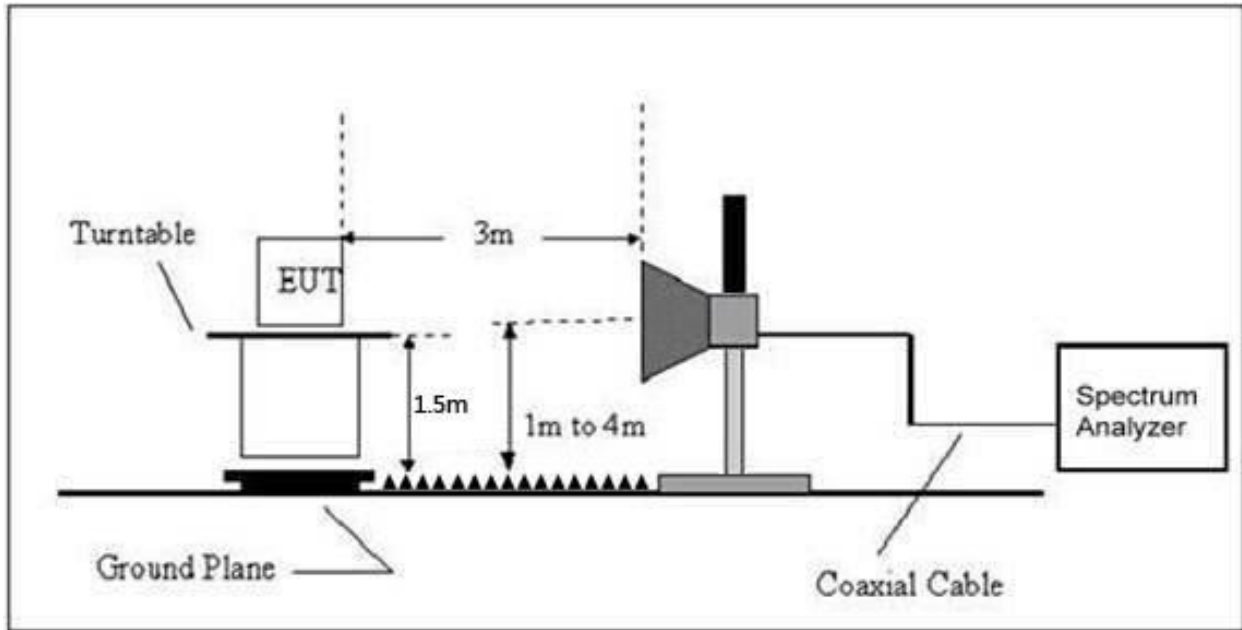

8.2 Limit

FCC Part15 C Section 15.209 and 15.205

(a) Except as shown in paragraph (d) of this section, only spurious emissions are permitted in any of the frequency bands listed below:

MHz	MHz	MHz	GHz
0.090-0.110	16.42-16.423	399.9-410	4.5-5.15
0.495-0.505	16.69475-16.69525	608-614	5.35-5.46
2.1735-2.1905	16.80425-16.80475	960-1240	7.25-7.75
4.125-4.128	25.5-25.67	1300-1427	8.025-8.5
4.17725-4.17775	37.5-38.25	1435-1626.5	9.0-9.2
4.20725-4.20775	73-74.6	1645.5-1646.5	9.3-9.5
6.215-6.218	74.8-75.2	1660-1710	10.6-12.7
6.26775-6.26825	108-121.94	1718.8-1722.2	13.25-13.4
6.31175-6.31225	123-138	2200-2300	14.47-14.5
8.291-8.294	149.9-150.05	2310-2390	15.35-16.2
8.362-8.366	156.52475-156.52525	2483.5-2500	17.7-21.4
8.37625-8.38675	156.7-156.9	2690-2900	22.01-23.12
8.41425-8.41475	162.0125-167.17	3260-3267	23.6-24.0
12.29-12.293	167.72-173.2	3332-3339	31.2-31.8
12.51975-12.52025	240-285	3345.8-3358	36.43-36.5
12.57675-12.57725	322-335.4	3600-4400	(?)
13.36-13.41			

Limits Of Radiated Emission Measurement (Above 1000MHz)

Frequency (MHz)	Limit (dBuV/m) (at 3M)	
	Peak	Average
Above 1000	74	54

Notes:

- (1)The limit for radiated test was performed according to FCC PART 15C.
- (2)The tighter limit applies at the band edges.
- (3)Emission level (dBuV/m)=20log Emission level (uV/m).

8.3 Test procedure

Receiver Parameter	Setting
Attenuation	Auto
Start Frequency	2300MHz
Stop Frequency	2520
RB / VB (Emission In Restricted Band)	1 MHz / 1 MHz for Peak, 1 MHz / 10Hz for Average

Above 1GHz test procedure as below:

- a.The EUT was placed on the top of a rotating table 1.5 meters above the ground at a 3 meter camber. The table was rotated 360 degrees to determine the position of the highest radiation.
- b.The EUT was set 3 meters away from the interference-receiving antenna, which was mounted on the top of a variable-height antenna tower.
- c.The antenna height is varied from one meter to four meters above the ground to determine the maximum value of the field strength. Both horizontal and vertical polarizations of the antenna are set to make the measurement.
- d.For each suspected emission, the EUT was arranged to its worst case and then the antenna was tuned to heights from 1 meter to 4 meters and the rota table was turned from 0 degrees to 360 degrees to find the maximum reading.
- e.The test-receiver system was set to Peak Detect Function and Specified Bandwidth with Maximum Hold Mode.
- f. If the emission level of the EUT in peak mode was 10dB lower than the limit specified, then testing could be stopped and the peak values of the EUT would be reported. Otherwise the emissions that did not have 10dB margin would be re-tested one by one using peak, quasi-peak or average method as specified and then reported in a data sheet.
- g. Test the EUT in the lowest channel, the Highest channel.

Note:

Both horizontal and vertical antenna polarities were tested and performed pretest to three orthogonal axis. The worst case emissions were reported.

8.4 EUT operating Conditions

The EUT was configured for testing in a typical fashion (as a customer would normally use it). The EUT has been programmed to continuously transmit during test. This operating condition was tested and used to collect the included data.

8.5 Test Result

Antenna 501013894

Test mode	Polar (H/V)	Frequency (MHz)	Reading Level (dBuV/m)	Correct Factor (dB)	Measurement (dBuV/m)	Limits (dBuV/m)	Result	
					PK			
Low Channel 902.2MHz								
FSK	H	900	41.29	-5.60	35.69	46.00	PASS	
	H	902	45.71	-5.54	40.17	46.00	PASS	
	V	900	41.23	-5.60	35.63	46.00	PASS	
	V	902	45.36	-5.54	39.82	46.00	PASS	
	High Channel 927.8MHz							
	H	928	44.45	-4.76	39.69	46.00	PASS	
	H	930	39.38	-4.70	34.68	46.00	PASS	
	V	928	43.24	-4.76	38.48	46.00	PASS	
V	930	40.48	-4.70	35.78	46.00	PASS		

Remark:

- 1.Measurement = Reading Level + Correct Factor,
Correct Factor = Antenna Factor + Cable Loss – Pre-amplifier,
Over= Measurement - Limit
2. If the PK measured levels comply with average limit, then the average level were deemed to comply with average limit.
- 3 In restricted bands of operation, The spurious emissions below the permissible value more than 20dB
4. The amplitude of spurious emissions which are attenuated by more than 20dB below the permissible value has no need to be reported.

Antenna 501013895

Test mode	Polar (H/V)	Frequency (MHz)	Reading Level (dBuV/m)	Correct Factor (dB)	Measurement (dBuV/m)	Limits (dBuV/m)	Result	
					PK			
Low Channel 902.2MHz								
FSK	H	900	42.89	-5.60	37.29	46.00	PASS	
	H	902	47.50	-5.54	41.96	46.00	PASS	
	V	900	43.76	-5.60	38.16	46.00	PASS	
	V	902	47.00	-5.54	41.46	46.00	PASS	
	High Channel 927.8MHz							
	H	928	46.04	-4.76	41.28	46.00	PASS	
	H	930	41.14	-4.70	36.44	46.00	PASS	
	V	928	47.78	-4.76	43.02	46.00	PASS	
V	930	44.04	-4.70	39.34	46.00	PASS		

Remark:

- 1.Measurement = Reading Level + Correct Factor,
Correct Factor = Antenna Factor + Cable Loss – Pre-amplifier,
Over= Measurement - Limit
2. If the PK measured levels comply with average limit, then the average level were deemed to comply with average limit.
- 3 In restricted bands of operation, The spurious emissions below the permissible value more than 20dB
4. The amplitude of spurious emissions which are attenuated by more than 20dB below the permissible value has no need to be reported.

9. Conducted Spurious Emission Measurement

9.1 Block Diagram Of Test Setup



9.2 Limit

Regulation 15.247 (d), In any 100 kHz bandwidth outside the frequency band in which the spread spectrum or digitally modulated intentional radiator is operating, the radio frequency power that is produced by the intentional radiator shall be at least 20 dB below that in the 100 kHz bandwidth within the band that contains the highest level of the desired power, based on either an RF conducted or a radiated measurement, provided the transmitter demonstrates compliance with the peak conducted power limits. If the transmitter complies with the conducted power limits based on the use of RMS averaging over a time interval, as permitted under paragraph (b)(3) of this section, the attenuation required under this paragraph shall be 30 dB instead of 20 dB. Attenuation below the general limits specified in §15.209(a) is not required. In addition, radiated emissions which fall in the restricted bands, as defined in §15.205(a), must also comply with the radiated emission limits specified in §15.209(a) (see §15.205(c))

9.3 Test procedure

1. Remove the antenna from the EUT and then connect a low RF cable from the antenna port to the spectrum;
2. Set the spectrum analyzer:
RBW = 100kHz, VBW = 300kHz, Sweep = auto
Detector function = peak, Trace = max hold



9.4 Test Result

30MHz – 25GHz

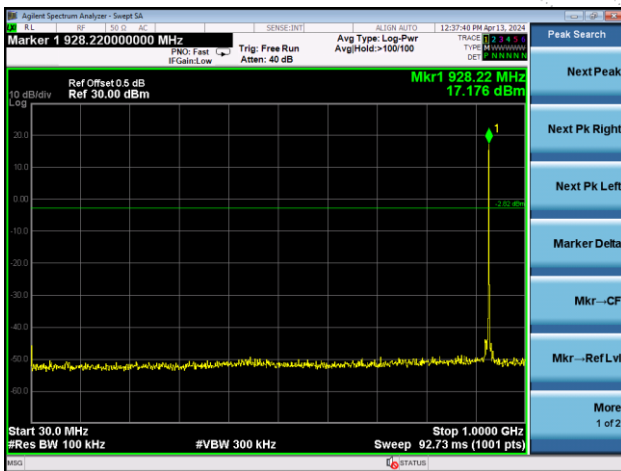
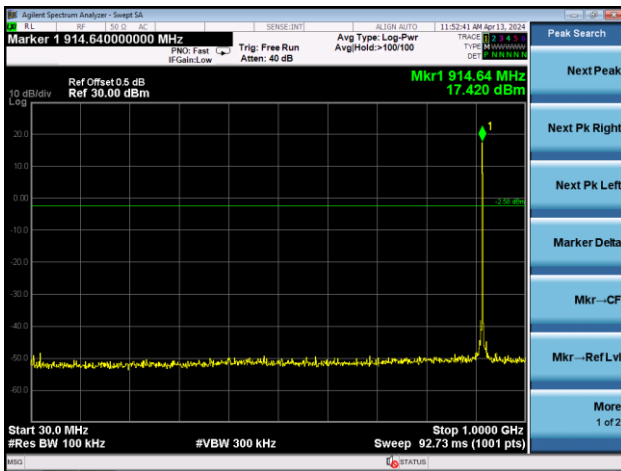
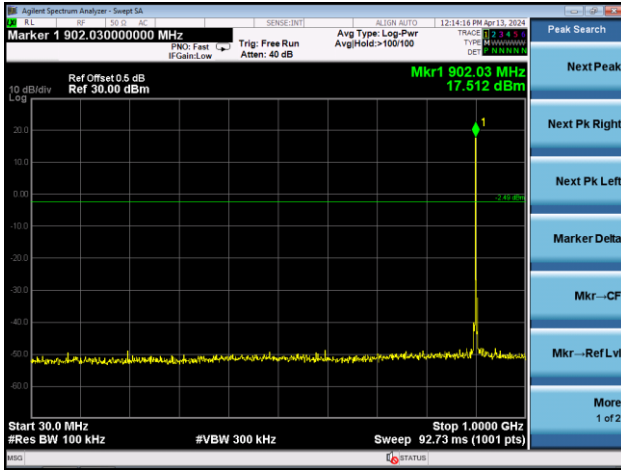

FSK Transmitting Band edge-left side

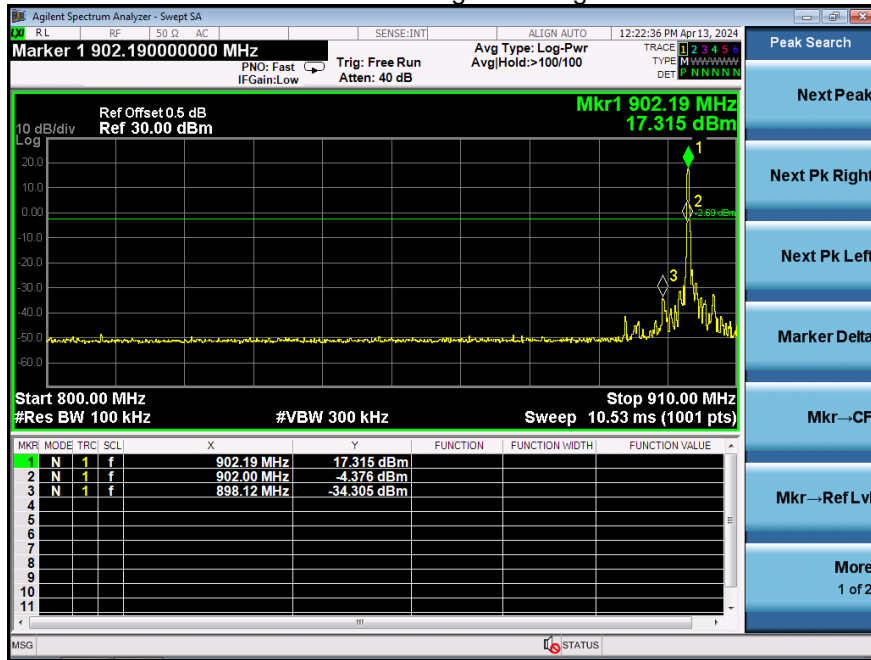

FSK Hopping Band edge-left side

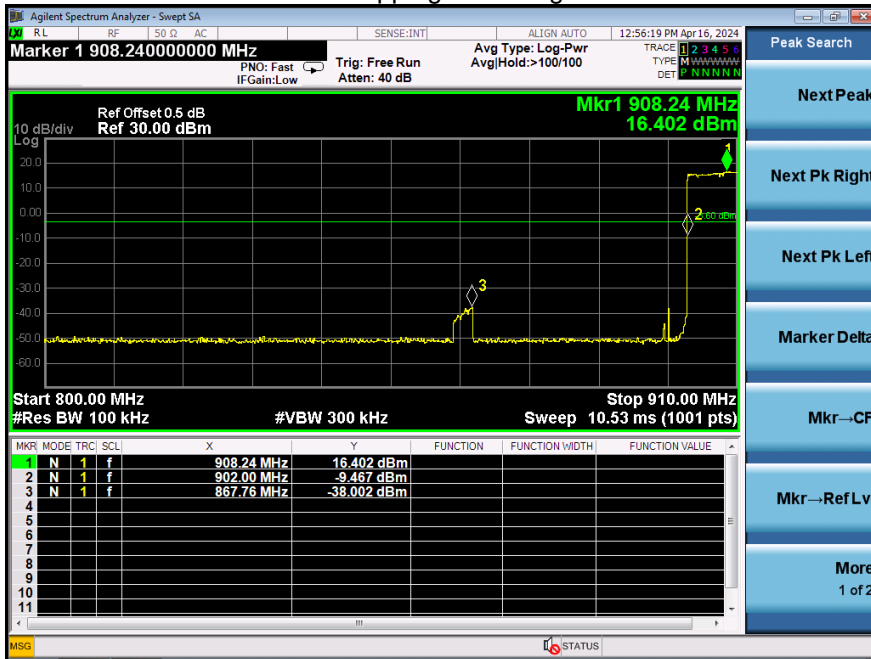

FSK Transmitting Band edge-right side

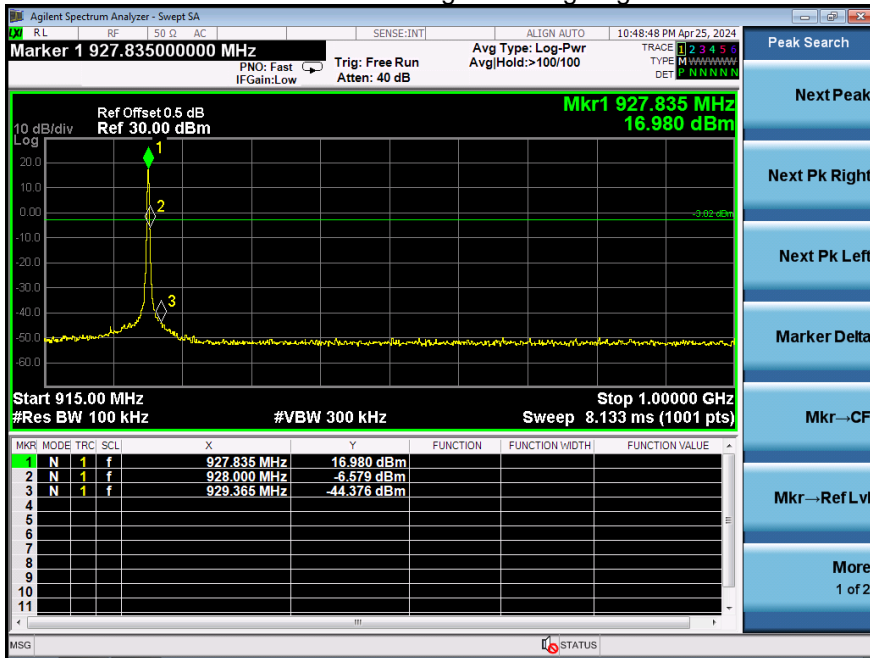

FSK Hopping Band edge-right side

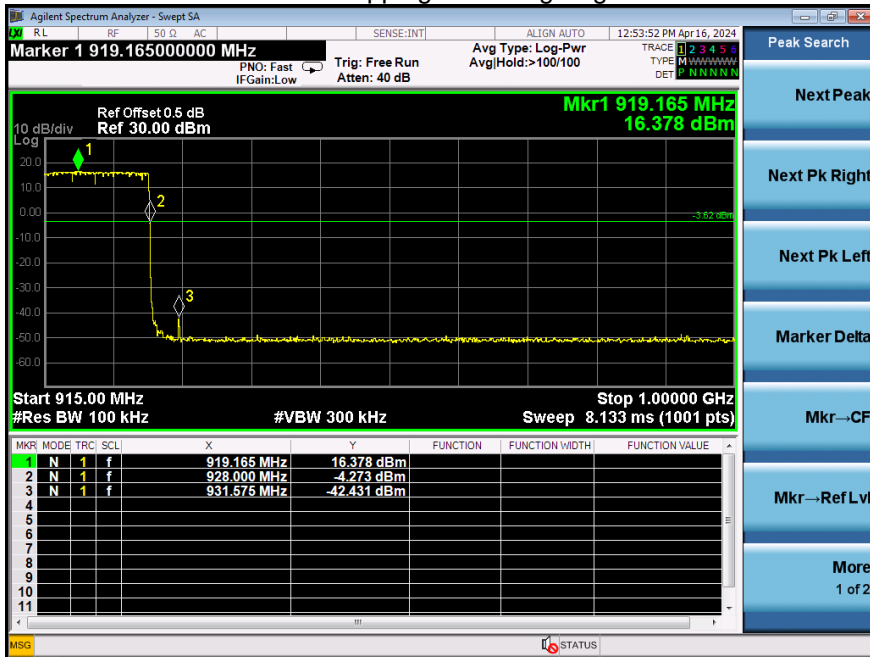

10. Occupy Bandwidth

10.1 Block Diagram Of Test Setup

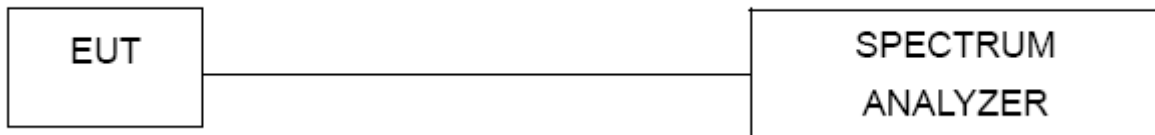

10.2 Limit

For frequency hopping systems operating in the 902-928 MHz band: The maximum allowed 20 dB bandwidth of the hopping channel is 250 kHz

10.3 Test procedure

1. The RF output of EUT was connected to the spectrum analyzer by RF cable and attenuator. The path loss was compensated to the results for each measurement.
2. Set to the maximum power setting and enable the EUT transmit continuously.
3. Use the following spectrum analyzer settings for 20dB Bandwidth measurement.
 Span = approximately 2 to 5 times the 20 dB bandwidth, centered on a hopping channel; $1\% \leq RBW \leq 5\%$ of the 20 dB bandwidth; $VBW \geq 3RBW$;
 Sweep = auto; Detector function = peak; Trace = max hold.
4. Measure and record the results in the test report.

10.4 Test Result

Test channel	FSK		
	20dB(kHz)	Limit(kHz)	Conclusion
Lowest	103.2	≤ 250	PASS
Middlest	102.2	≤ 250	PASS
Highest	103.1	≤ 250	PASS

Lowest channel

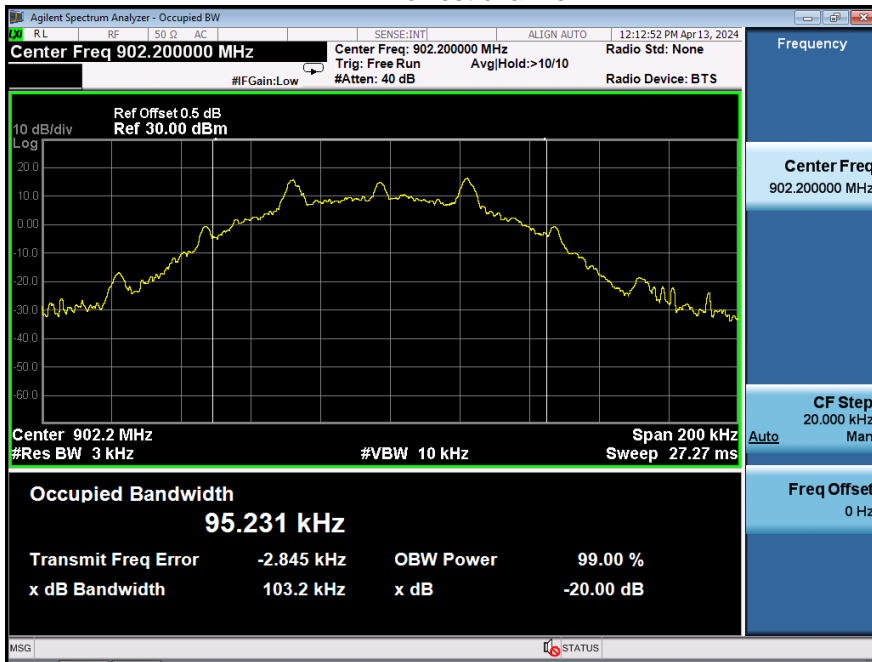

Middlest channel

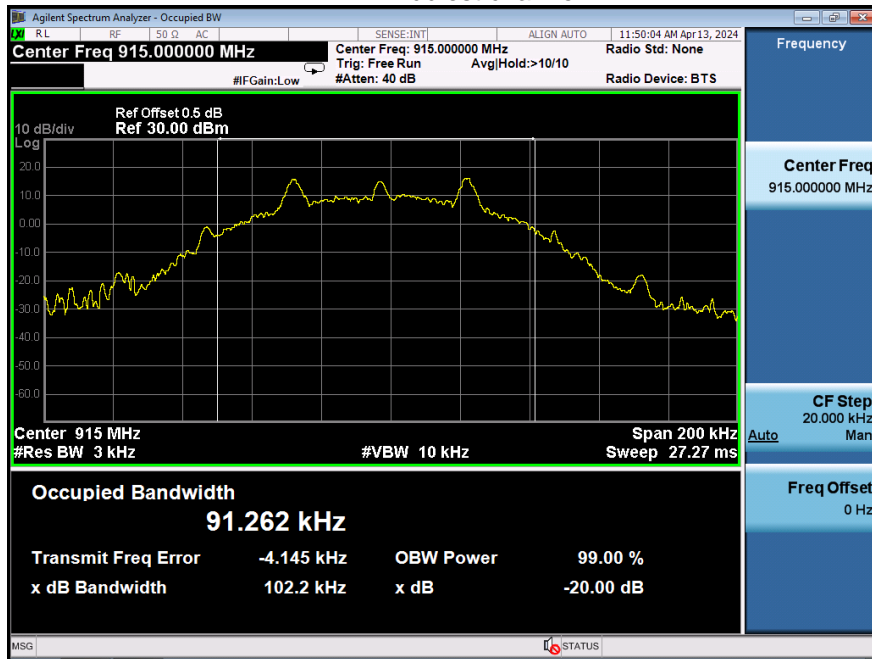

Highest channel

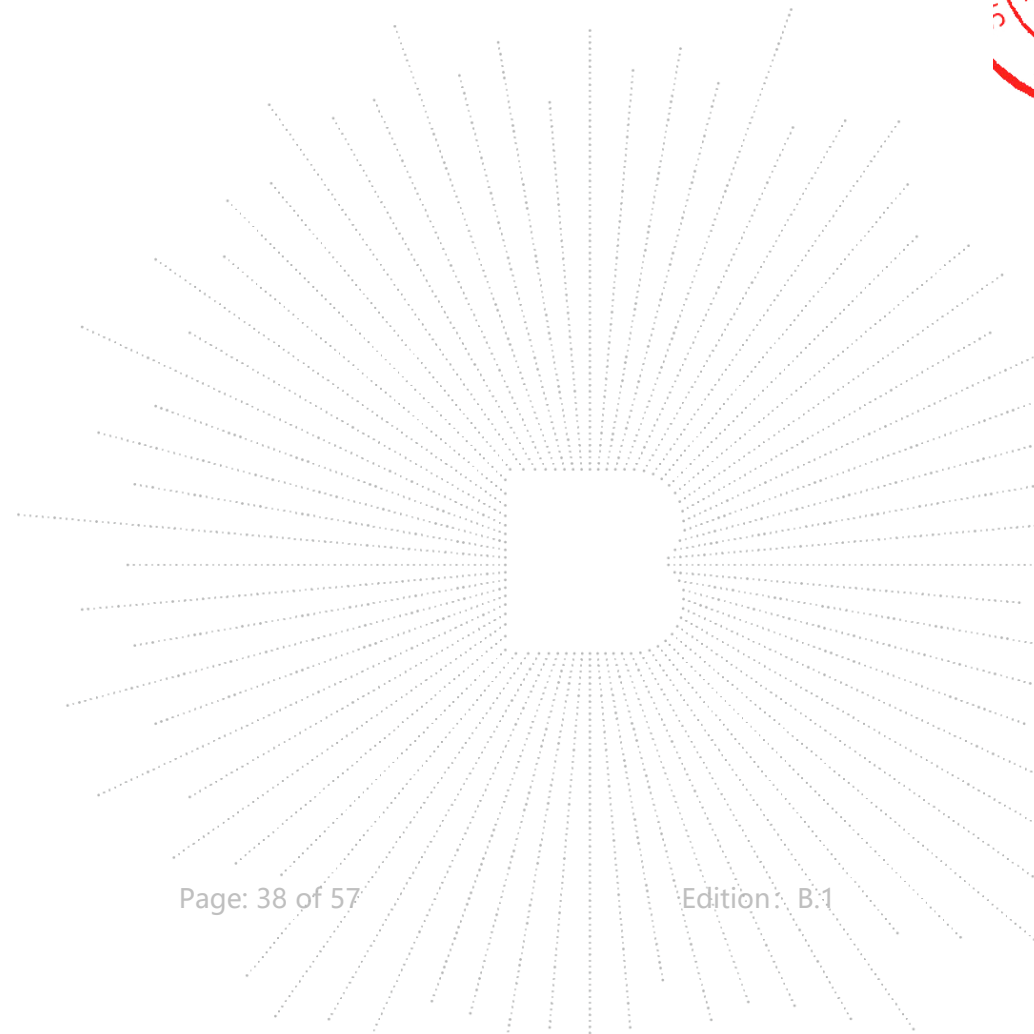
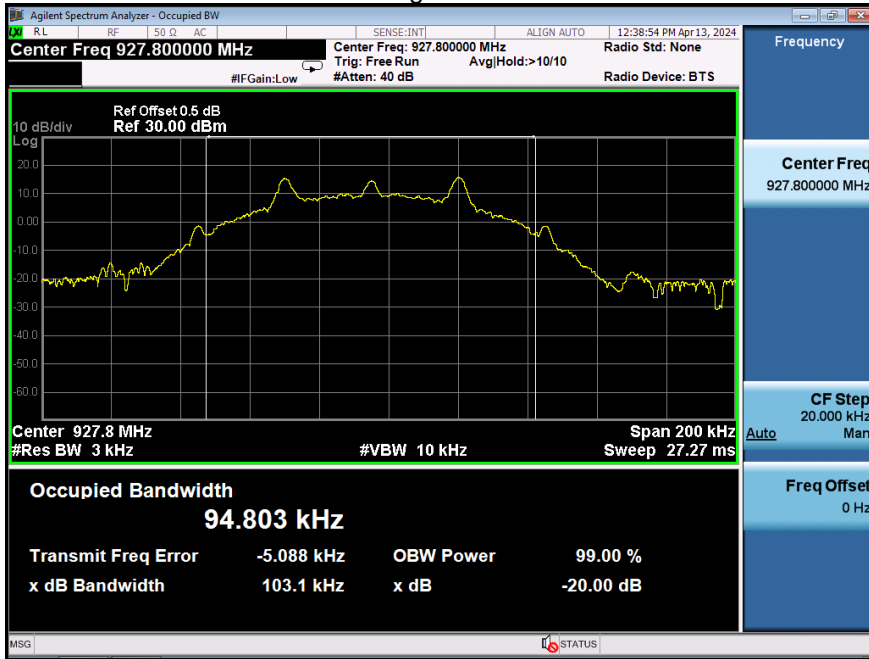

11. Conducted Output Power

11.1 Block Diagram Of Test Setup



11.2 Limit

For frequency hopping systems operating in the 902-928 MHz band: 1 watt for systems employing at least 50 hopping channels; and, 0.25 watts for systems employing less than 50 hopping channels, but at least 25 hopping channels, as permitted under paragraph (a)(1)(i) of this section.

11.3 Test procedure

Use the following spectrum analyzer settings:

Span = approximately 5 times the 20 dB bandwidth,
centered on a hopping channel

RBW > the 20 dB bandwidth of the emission being measured VBW ≥ RBW

Sweep = auto

Detector function = peak

Trace = max hold

Allow the trace to stabilize.

Use the marker-to-peak function to set the marker to the peak of the emission.

11.4 Test Result

FSK			
Test channel	Peak Output Power (dBm)	Limit (dBm)	Result
Lowest	17.578	30.00	PASS
Middlest	17.599	30.00	PASS
Highest	17.421	30.00	PASS

Lowest channel

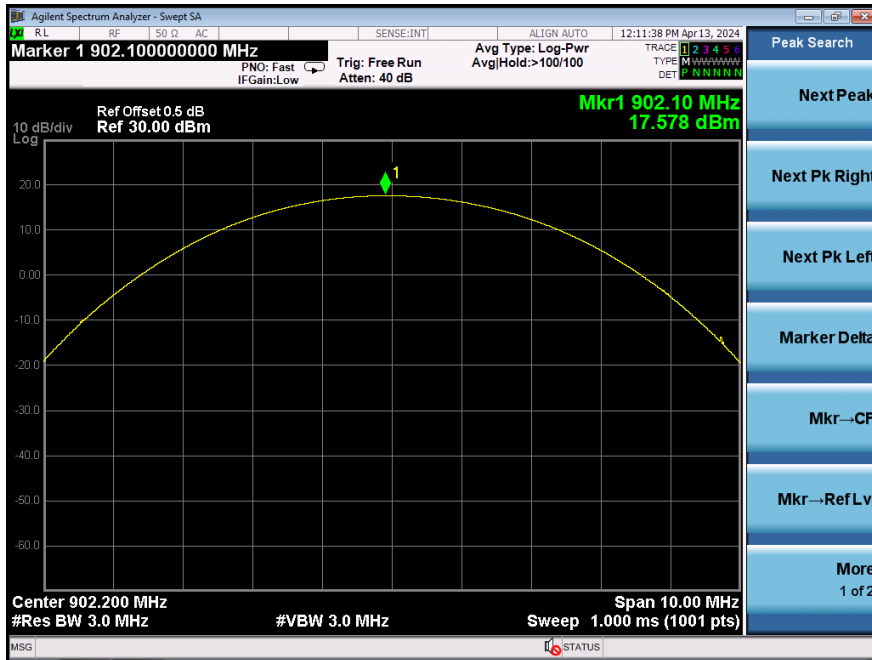

Middlest channel

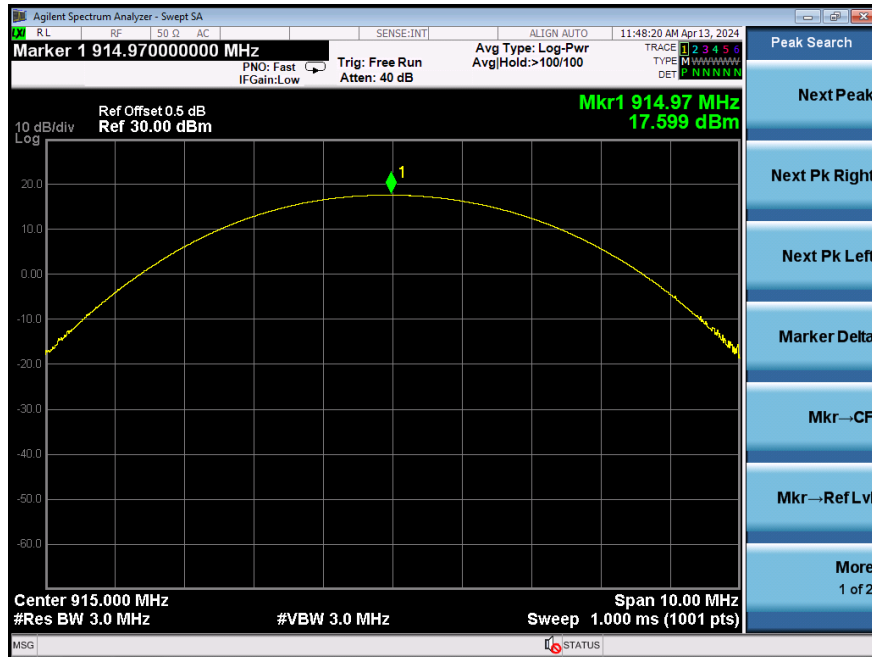

Highest channel

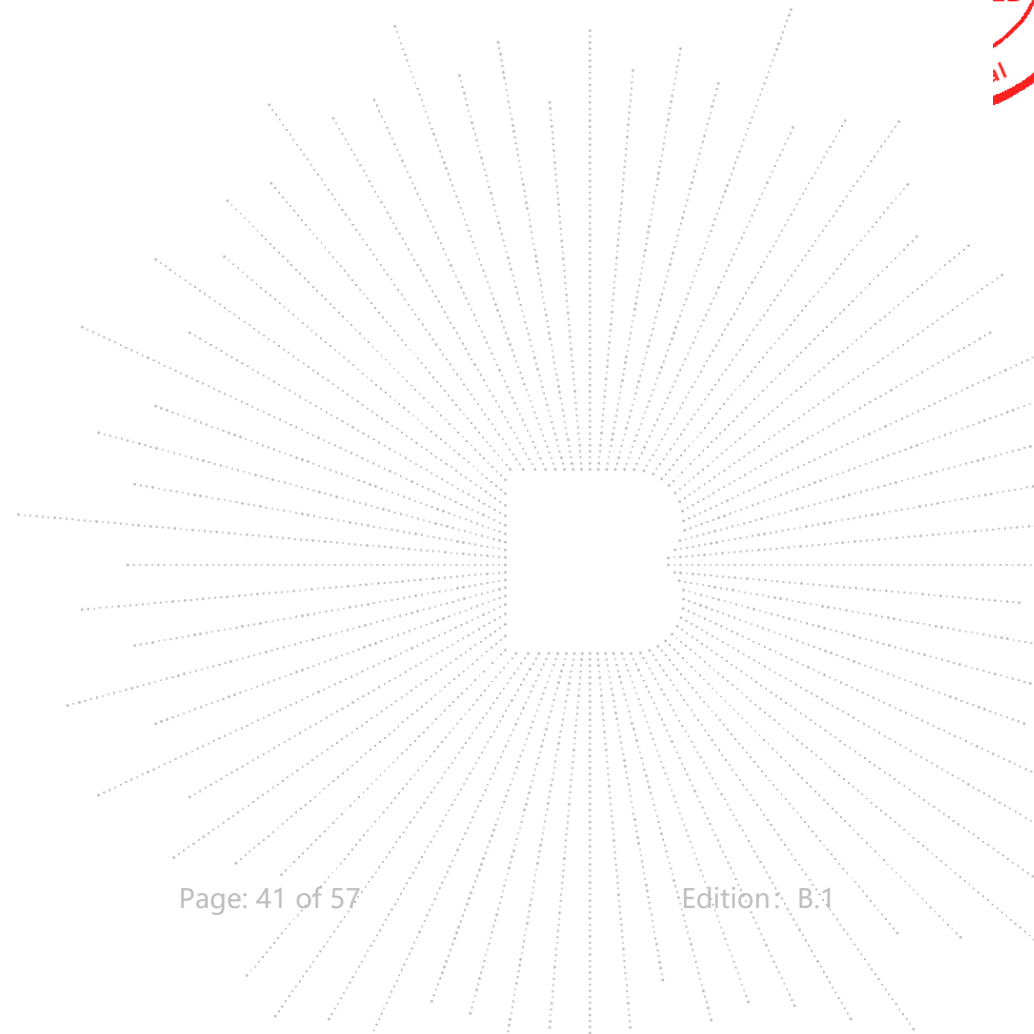
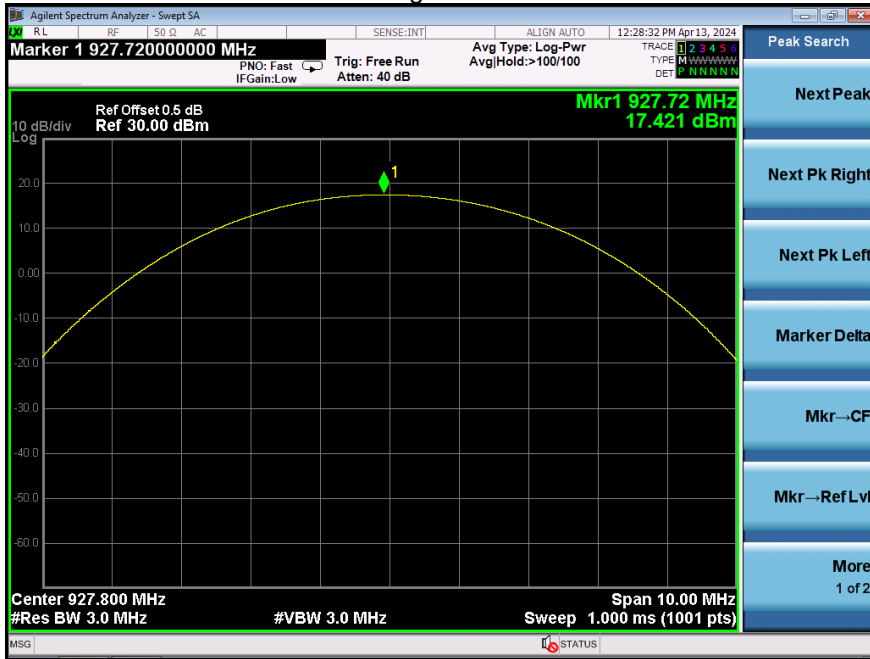

12. Hopping Channel Separation

12.1 Block Diagram Of Test Setup

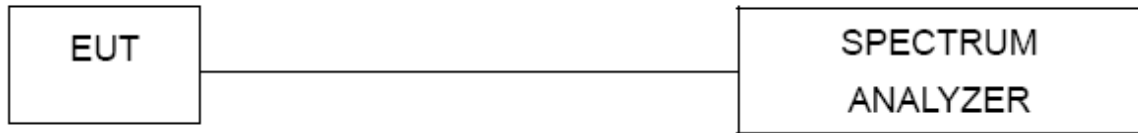

12.2 Limit

Frequency hopping systems shall have hopping channel carrier frequencies separated by a minimum of 25 kHz or the 20 dB bandwidth of the hopping channel, whichever is greater.

12.3 Test procedure

1. Remove the antenna from the EUT and then connect a low RF cable from the antenna port to the spectrum.
2. Set the spectrum analyzer: RBW = 30kHz. VBW = 100kHz, Span = 1.0MHz. Sweep = auto; Detector Function = Peak. Trace = Max hold.
3. Allow the trace to stabilize. Use the marker-delta function to determine the separation between the peaks of the adjacent channels. The limit is specified in one of the subparagraphs of this Section Submit this plot.

12.4 Test Result

For FHSS:

FSK			
Test channel	Carrier Frequencies Separation (kHz)	Limit (kHz)	Result
Lowest	199.6	103.2	PASS
Middlest	200.4	102.2	PASS
Highest	200.4	103.1	PASS

Lowest channel



Middlest channel



SHENZHEN

Highest channel

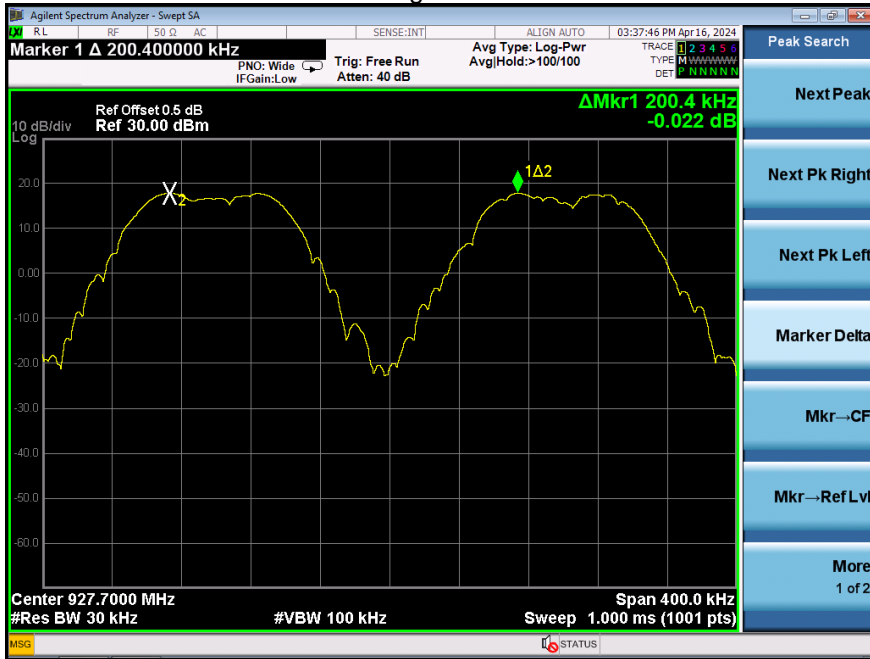

13. Number Of Hopping Frequency

13.1 Block Diagram Of Test Setup



13.2 Limit

For frequency hopping systems operating in the 902-928 MHz band: if the 20 dB bandwidth of the hopping channel is less than 250 kHz, the system shall use at least 50 hopping frequencies; if the 20 dB bandwidth of the hopping channel is 250 kHz or greater, the system shall use at least 25 hopping frequencies.

13.3 Test procedure

1. The RF output of EUT was connected to the spectrum analyzer by RF cable and attenuator. The path loss was compensated to the results for each measurement.
2. Set to the maximum power setting and enable the EUT transmit continuously.
3. Enable the EUT hopping function.
4. Use the following spectrum analyzer settings: Span = the frequency band of operation; set the RBW to less than 30% of the channel spacing or the 20 dB bandwidth, whichever is smaller; VBW \geq RBW; Sweep = auto; Detector function = peak; Trace = max hold
5. The number of hopping frequency used is defined as the number of total channel.
6. Record the measurement data in report.

13.4 Test Result

Mode	Hopping channel numbers	Limit	Result
FSK	129	50	PASS

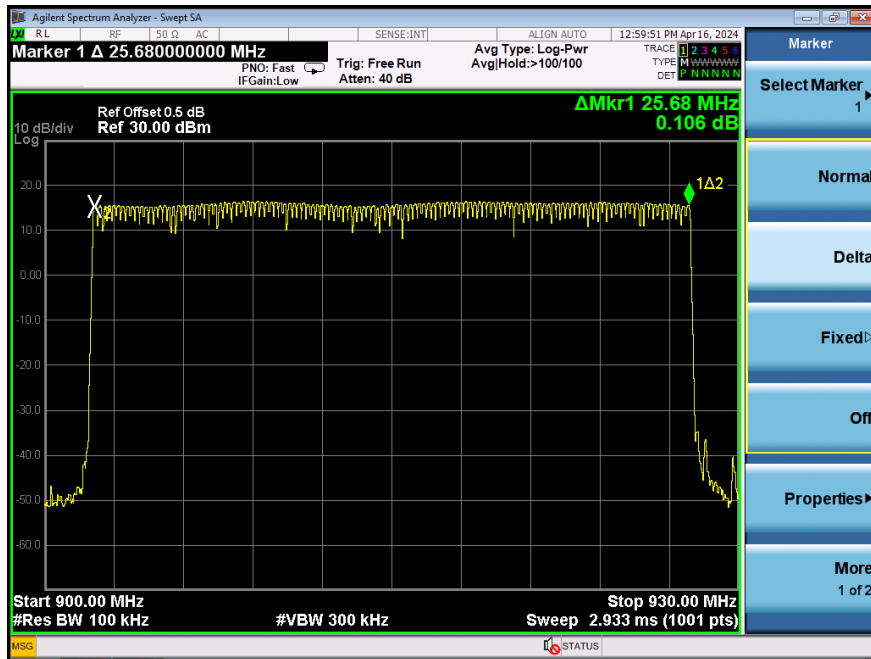

14. Dwell Time

14.1 Block Diagram Of Test Setup

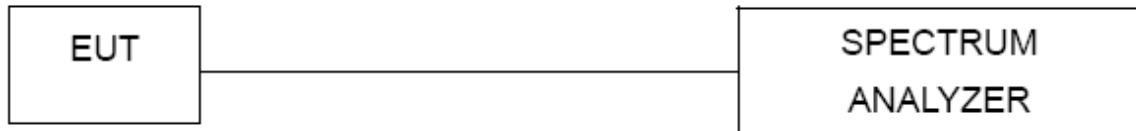

14.2 Limit

For frequency hopping systems operating in the 902-928 MHz band: if the 20 dB bandwidth of the hopping channel is less than 250 kHz, the system shall use at least 50 hopping frequencies and the average time of occupancy on any frequency shall not be greater than 0.4 seconds within a 20 second period; if the 20 dB bandwidth of the hopping channel is 250 kHz or greater, the system shall use at least 25 hopping frequencies and the average time of occupancy on any frequency shall not be greater than 0.4 seconds within a 10 second period. The maximum allowed 20 dB bandwidth of the hopping channel is 500 kHz.

14.3 Test procedure

1. The RF output of EUT was connected to the spectrum analyzer by RF cable and attenuator. The path loss was compensated to the results for each measurement.
2. Set to the maximum power setting and enable the EUT transmit continuously.
3. Enable the EUT hopping function.
4. The spectrum analyzer is set to:
Center frequency = 914.75MHz, Span = zero
RBW = 100 kHz (RBW shall be \leq channel spacing and where possible RBW should be set $\gg 1 / T$, where T is the expected dwell time per channel),
VBW \geq RBW Detector function = peak,
Trace = max hold
5. Measure and record the results in the test report.

14.4 Test Result

Length (ms)	Number	Dwell time (ms)	Limit (ms)	Result
28.8	1	28.8	400	PASS

Note: Dwell time= Length* Number

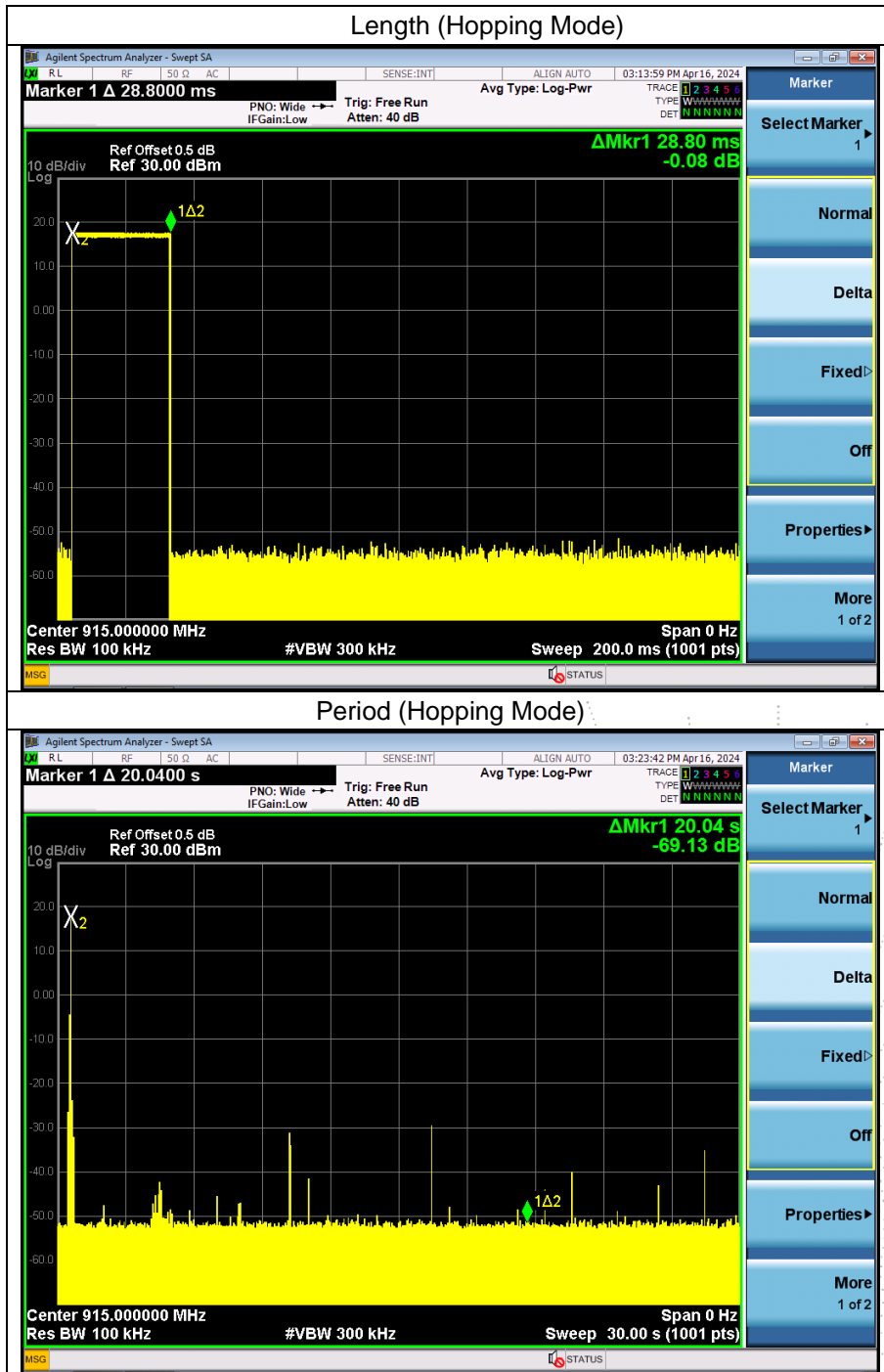

CO., LTD.

15. Antenna Requirement

15.1 Limit

15.203 requirement: For intentional device, according to 15.203: an intentional radiator shall be designed to ensure that no antenna other than that furnished by the responsible party shall be used with the device.

15.2 Test Result

The EUT antenna is FPC antenna, antenna 501013894: 0dbi, antenna 501013895: 2.2dbi, antenna connector type is IPEX, fulfill the requirement of this section.

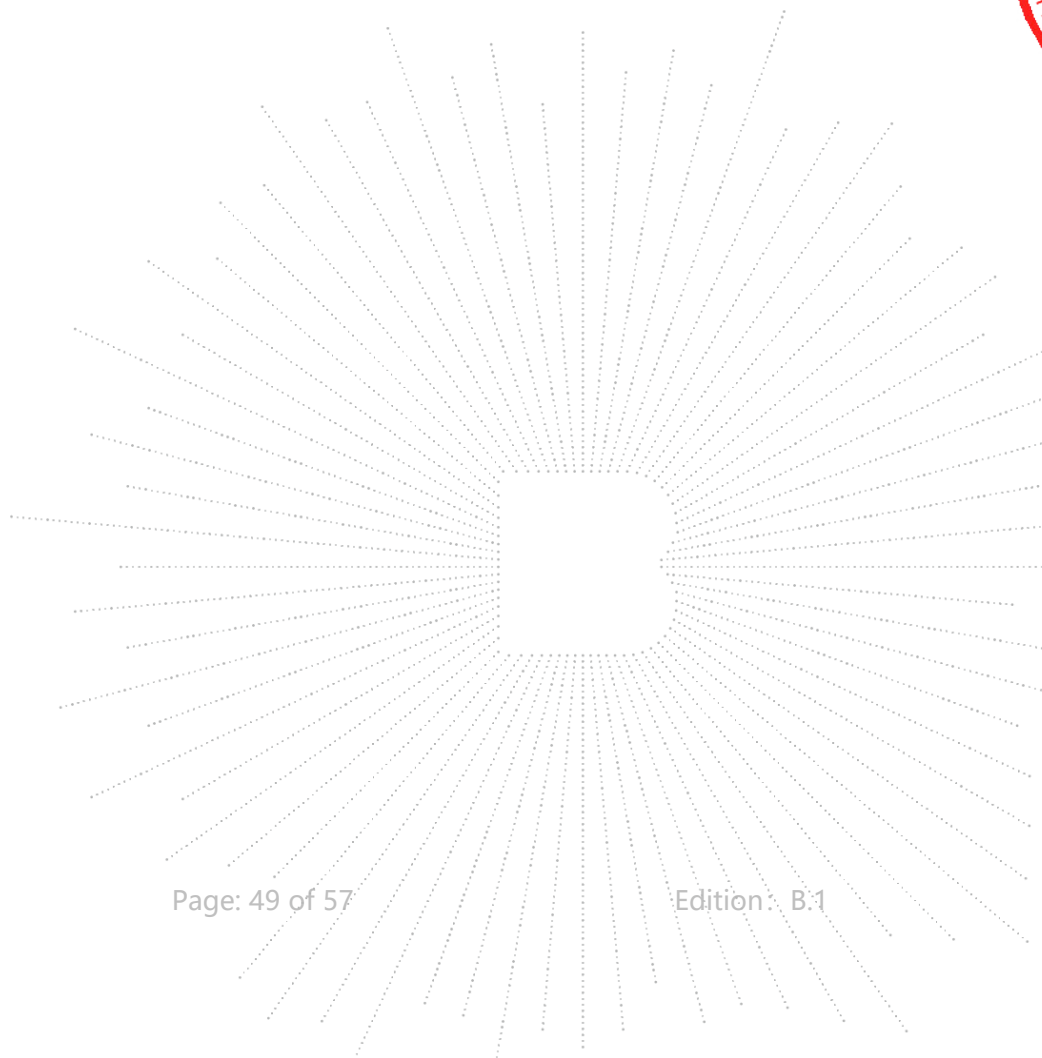

16. EUT Photographs

EUT Photo 1

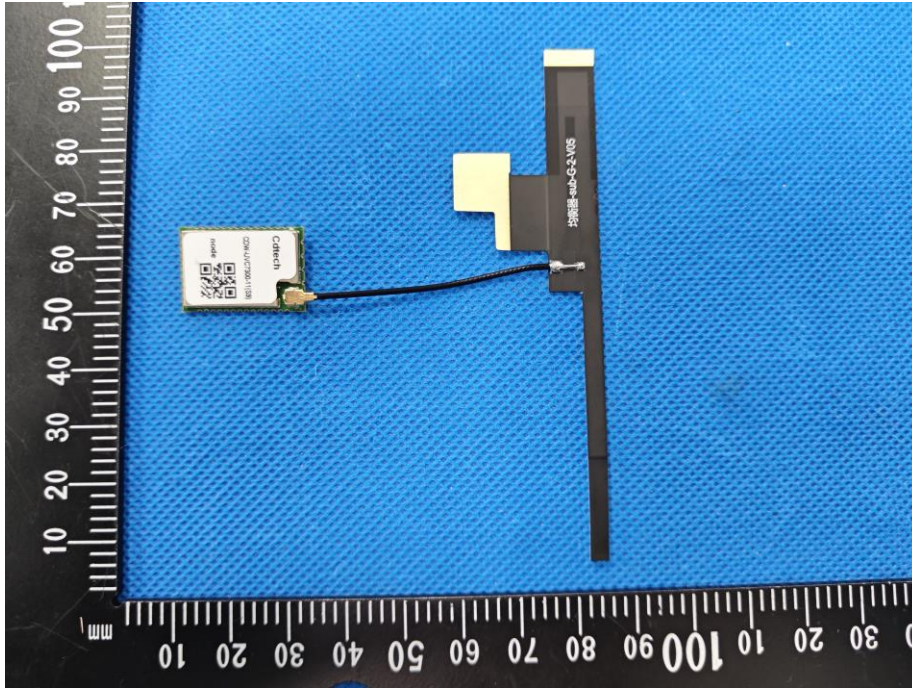

EUT Photo 2

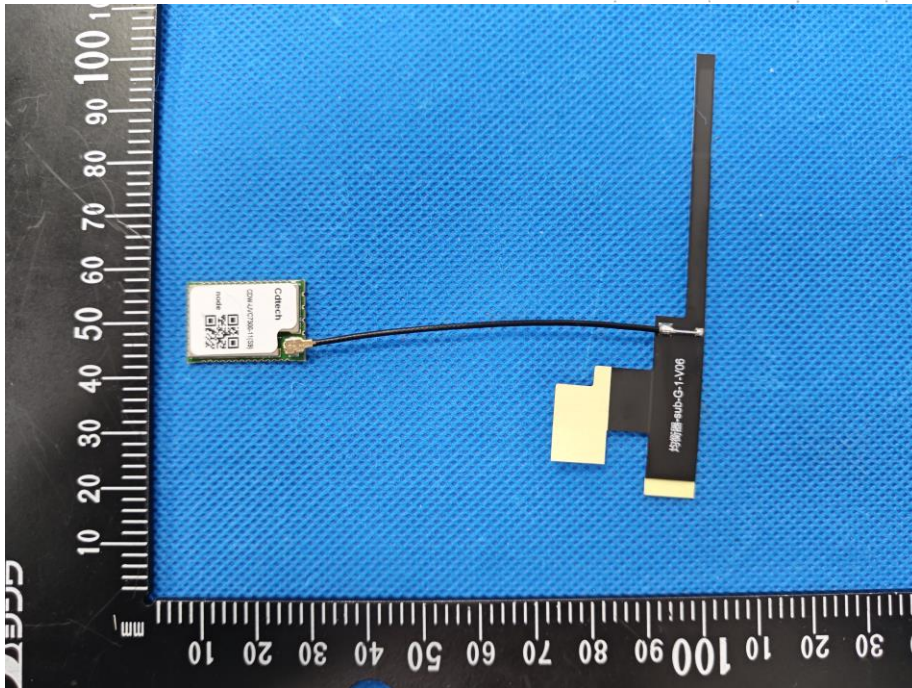

NOTE: Appendix-Photographs Of EUT Constructional Details

17. EUT Test Setup Photographs

Conducted emissions
Antenna 501013894

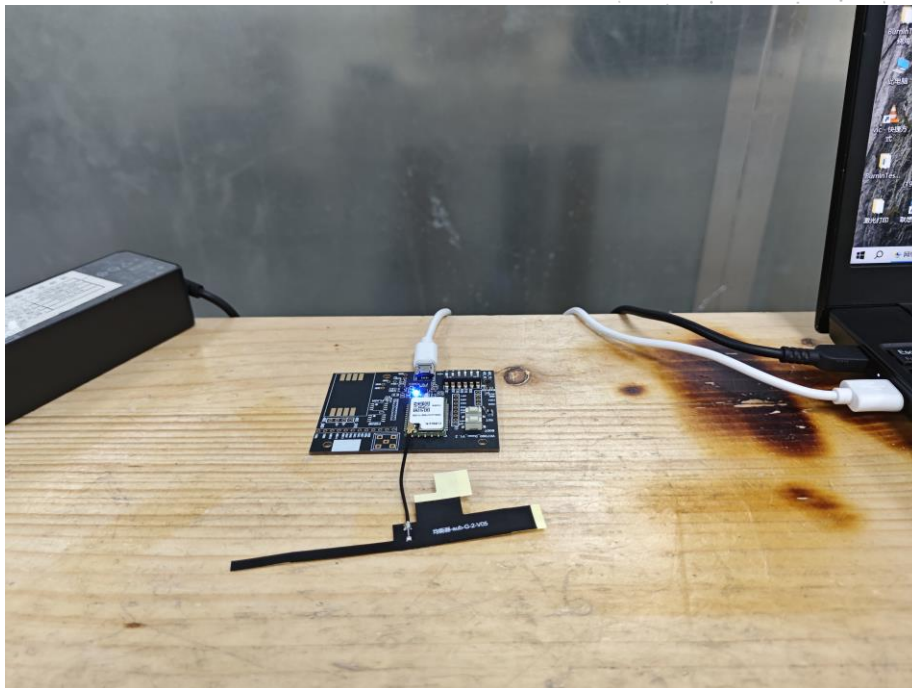

Antenna 501013895

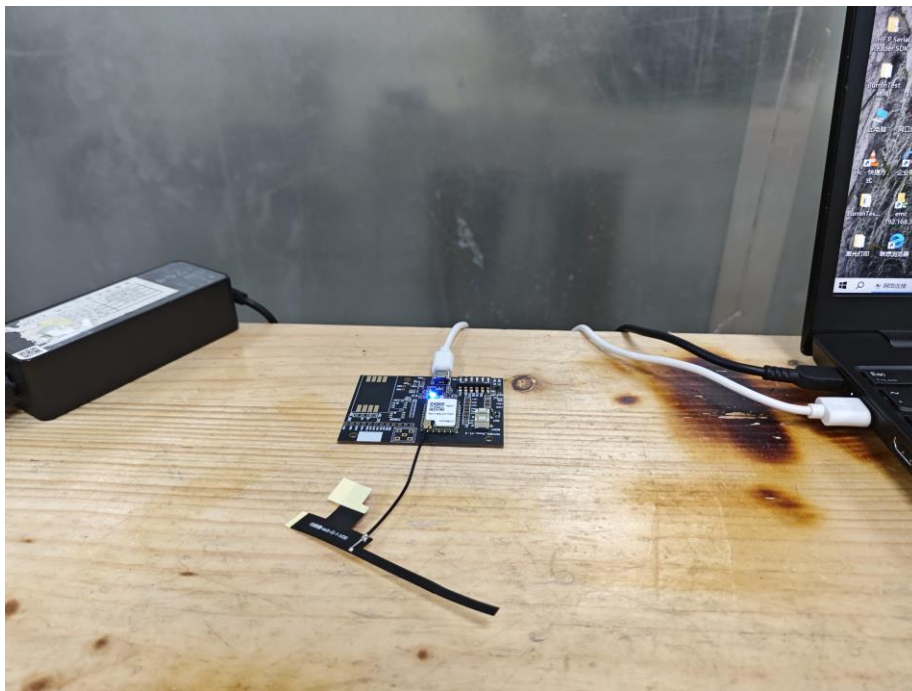
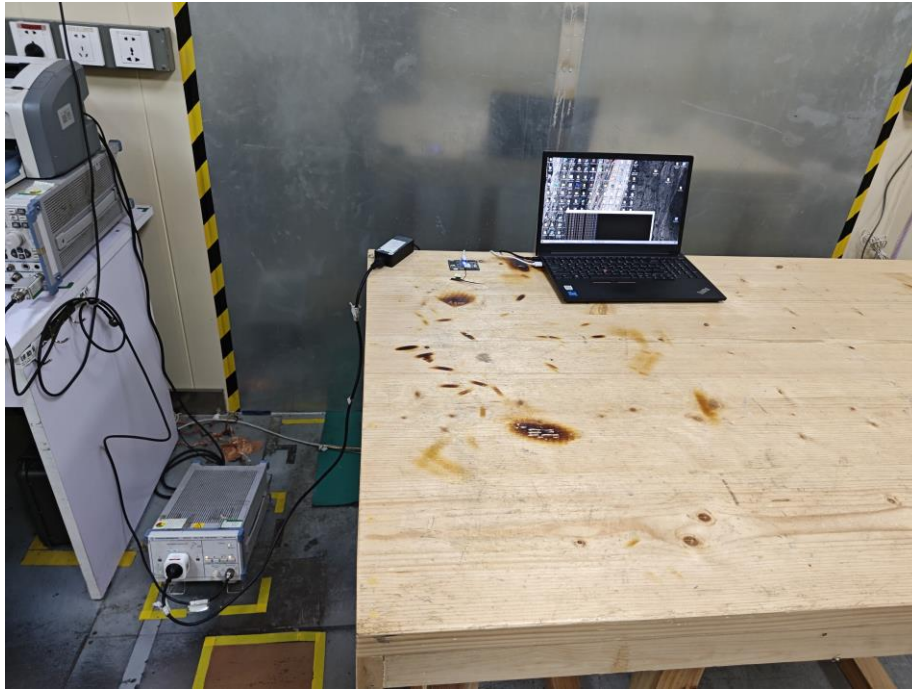

Radiated Measurement Photos
Antenna 501013894

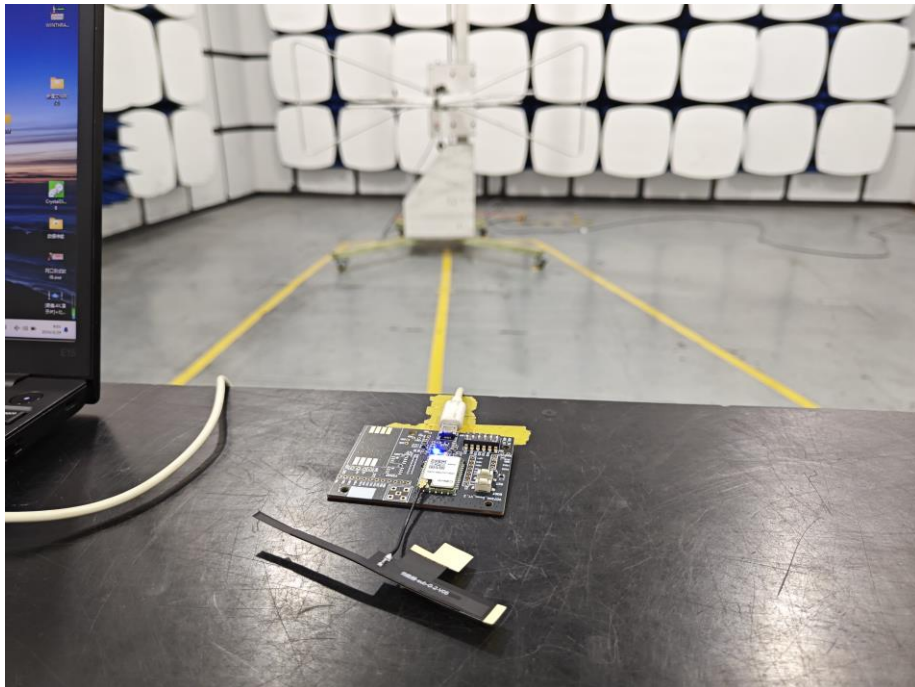

Antenna 501013895

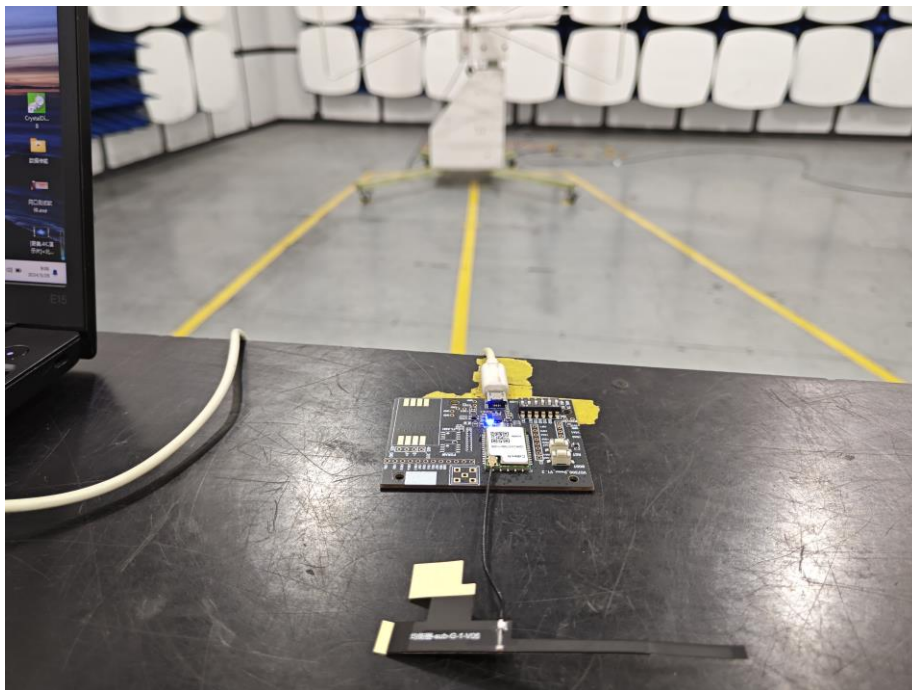
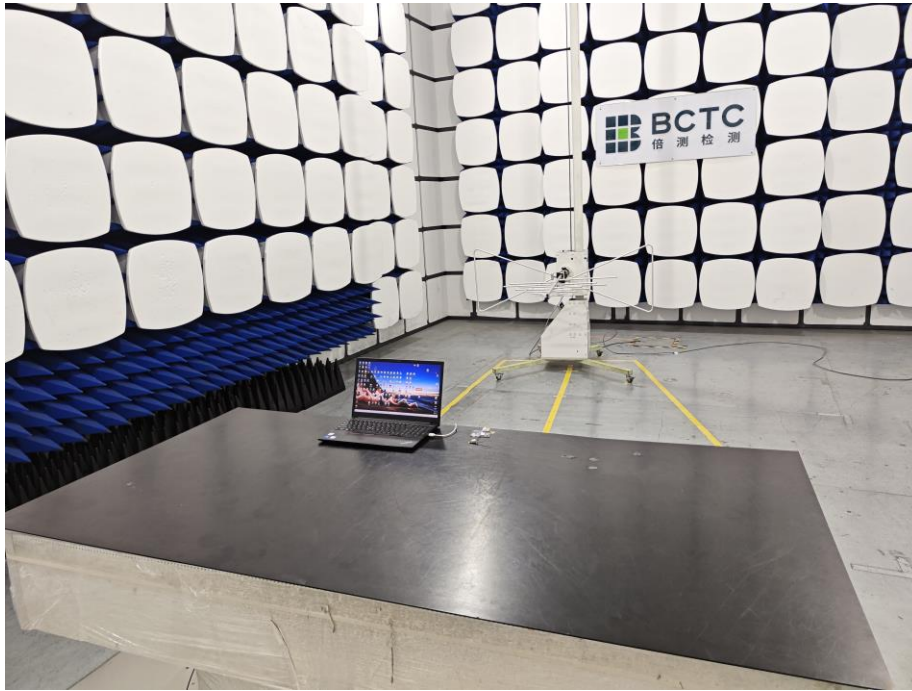

Antenna 501013894

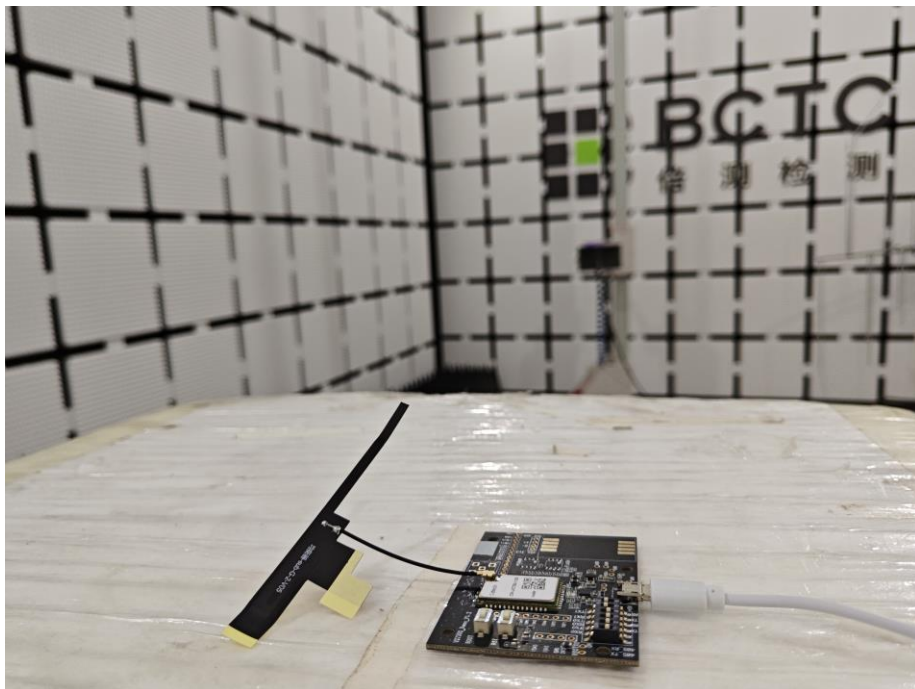

Antenna 501013895

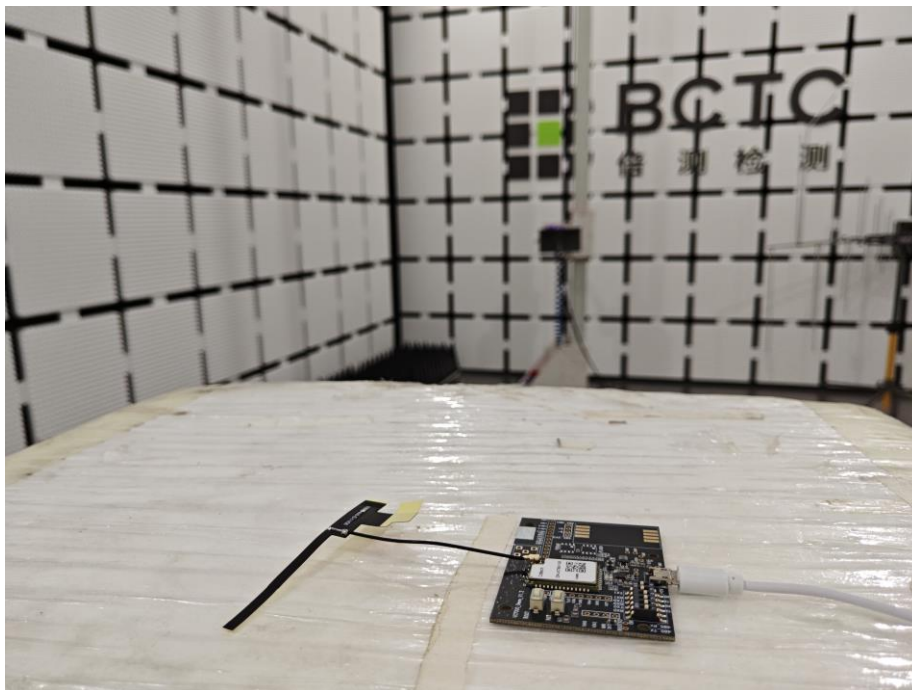
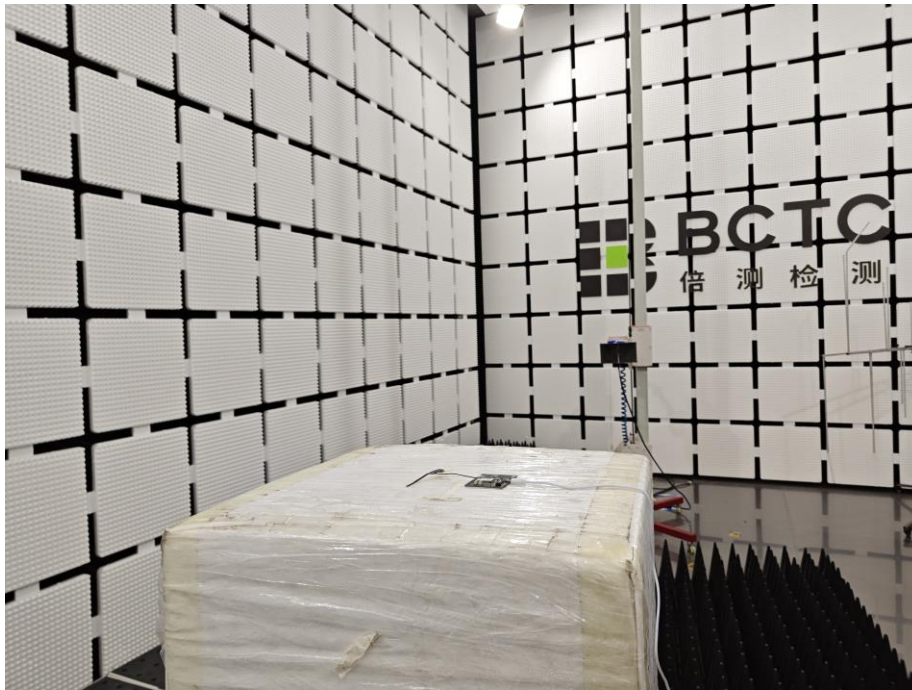

STATEMENT

1. The equipment lists are traceable to the national reference standards.
2. The test report can not be partially copied unless prior written approval is issued from our lab.
3. The test report is invalid without the "special seal for inspection and testing".
4. The test report is invalid without the signature of the approver.
5. The test process and test result is only related to the Unit Under Test.
6. Sample information is provided by the client and the laboratory is not responsible for its authenticity.
7. The quality system of our laboratory is in accordance with ISO/IEC17025.
8. If there is any objection to this test report, the client should inform issuing laboratory within 15 days from the date of receiving test report.

Address:

1-2/F., Building B, Pengzhou Industrial Park, No.158, Fuyuan 1st Road, Zhancheng, Fuhai Subdistrict, Bao'an District, Shenzhen, Guangdong, China

TEL: 400-788-9558

P.C.: 518103

FAX: 0755-33229357

Website: <http://www.chnbctc.com>E-Mail: bctc@bctc-lab.com.cn

***** END *****

2017