

Application:

WLAN, 802.11b/g, Bluetooth, etc...

Features

SMD, high reliability, ultra Impact, Omni-directional...

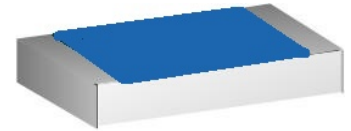

Part number

AAN 3216 - F5 P 2G45
 (1) (2) (3) (4) (5)

(1)Product Type	Chip Antenna
(2)Size Code	3.2x1.6mm
(3)Type Code	F5
(4)Packing	Paper Tape
(5)Frequency	2.45GHz

Electrical Specification

Working Frequency Range	2400 ~2484 MHz
Peak Gain	1.8 dBi (Typ.)
Impedance	50 Ohm
Return loss	10 dB (Min)
Polarization	Linear
Azimuth Beamwidth	Omni-directional
Operation Temperature(°C)	-40 ~85°C

The specification is defined on EVB.

Dimension and Terminal Configuration

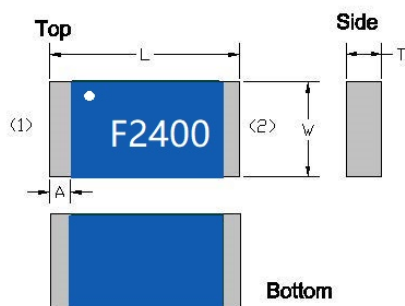

Dimension (mm)	
L	3.15±0.15
W	1.55±0.15
T	0.50±0.10
A	0.35±0.10

No.	Terminal Name
1	Feeding point
2	GND

Evaluation Board Reference

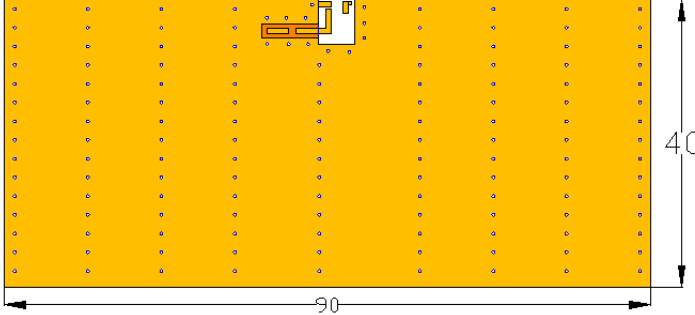
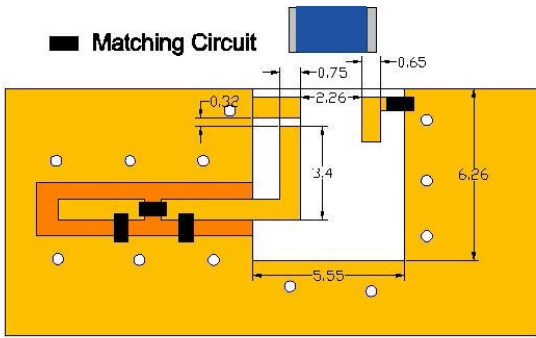
PCB Dimension	Antenna Layout Reference
<p>PCB Dimension</p> 	<p>Antenna Layout Reference</p>  <p style="text-align: right;">unit :mm</p>

Electrical Characteristics

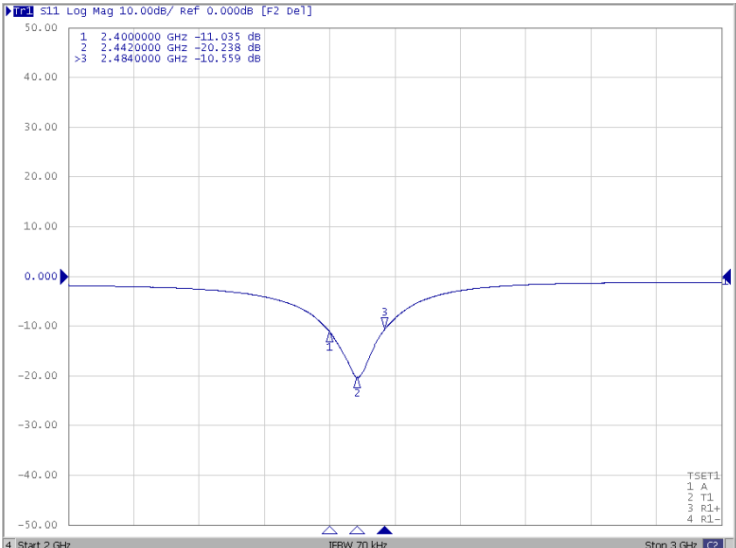
Return Loss & Radiation																								
<p>Return Loss</p>  <table border="1" style="font-size: small; margin-top: 10px;"> <tr><td>1</td><td>2.4000000</td><td>GHz</td><td>-11.035</td><td>dB</td></tr> <tr><td>2</td><td>2.4420000</td><td>GHz</td><td>-20.238</td><td>dB</td></tr> <tr><td>>3</td><td>2.4840000</td><td>GHz</td><td>-10.559</td><td>dB</td></tr> </table>	1	2.4000000	GHz	-11.035	dB	2	2.4420000	GHz	-20.238	dB	>3	2.4840000	GHz	-10.559	dB	<table border="1" style="width: 100%; border-collapse: collapse; text-align: center;"> <thead> <tr style="background-color: #e0e0e0;"> <th>Frequency (MHz)</th> <th>S11 (dB)</th> </tr> </thead> <tbody> <tr><td>2400</td><td>-11.0</td></tr> <tr><td>2442</td><td>-20.2</td></tr> <tr><td>2484</td><td>-10.6</td></tr> </tbody> </table>	Frequency (MHz)	S11 (dB)	2400	-11.0	2442	-20.2	2484	-10.6
1	2.4000000	GHz	-11.035	dB																				
2	2.4420000	GHz	-20.238	dB																				
>3	2.4840000	GHz	-10.559	dB																				
Frequency (MHz)	S11 (dB)																							
2400	-11.0																							
2442	-20.2																							
2484	-10.6																							

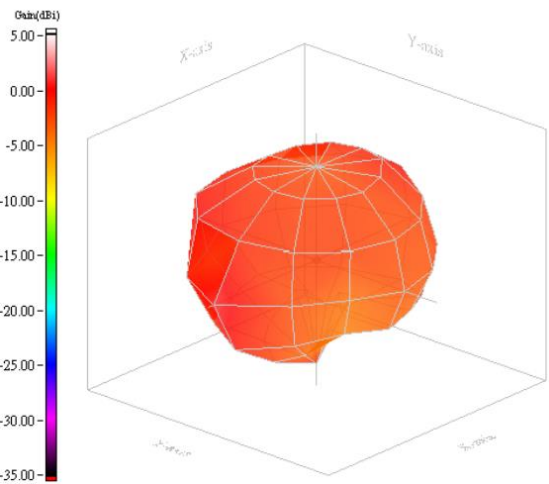
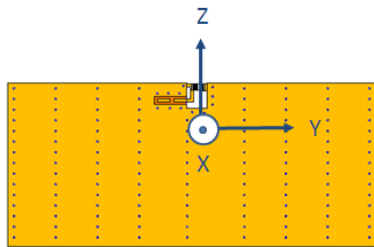
<p>Radiation</p> 	 <p>2.45GHz</p> <table border="1" style="width: 100%; border-collapse: collapse; text-align: center;"> <tr><td>Frequency</td><td>2445MHz</td></tr> <tr><td>Peak gain</td><td>1.8dBi</td></tr> <tr><td>Efficiency</td><td>68.5%</td></tr> </table>	Frequency	2445MHz	Peak gain	1.8dBi	Efficiency	68.5%
Frequency	2445MHz						
Peak gain	1.8dBi						
Efficiency	68.5%						

Taping Specifications

Reel and Taping Specification

Reel Specification

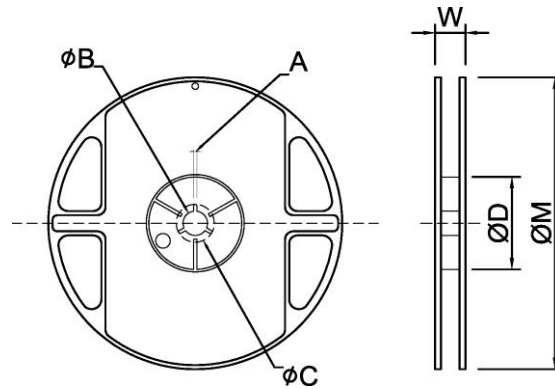

TYPE	SIZE		A	ϕB	ϕC	ϕD	W	ϕM
3216	7"	3K/Reel	2.0±0.5	13.5±1.0	21±1.0	60±1.0	11.5±2.0	178±2.0

Tapping Specification

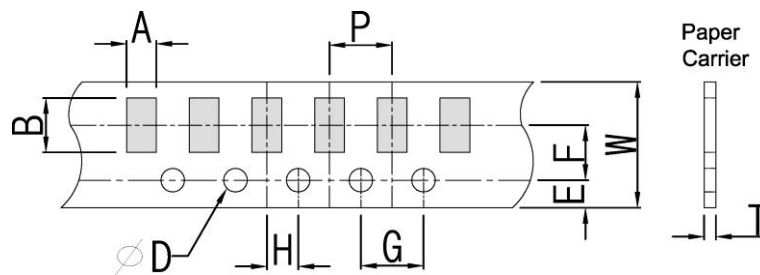

Packaging	Type	A	B	W	E	F	G	H	T	ϕD	P
Paper Type	3216	1.90±0.20	3.50±0.20	8.0±0.20	1.75±0.10	3.5±0.05	4.0±0.10	2.0±0.05	0.75±0.10	1.50 +0.10 -0	4.0±0.1

Reliability Table

Test Item	Procedure	Requirements Ceramic Type	Remark (Reference)
Electrical Characterization		Fulfill the electrical specification	User Spec.
Thermal Shock	1. Preconditioning: $50 \pm 10^{\circ}\text{C}$ / 1 hr , then keep for 24 ± 1 hrs at room temp. 2. Initial measure: Spec: refer Initial spec. 3. Rapid change of temperature test: -30°C to $+85^{\circ}\text{C}$; 100 cycles; 15 minutes at Lower category temperature; 15 minutes at Upper category temperature.	No Visible Damage. Fulfill the electrical specification.	MIL-STD-202 107
Temperature Cycling	1. Initial measure: Spec: refer Initial spec. 2. 100 Cycles (-30°C to $+85^{\circ}\text{C}$), Soak Mode=1 (2 Cycle/hours). 3. Measurement at 24 ± 2 Hours after test condition.	No Visible Damage. Fulfill the electrical specification.	JESD22 JA104
High Temperature Exposure	1. Initial measure: Spec: refer Initial spec. 2. Unpowered; 500hours @ $T=+85^{\circ}\text{C}$. 3. Measurement at 24 ± 2 hours after test.	No Visible Damage. Fulfill the electrical specification.	MIL-STD-202 108
Low Temperature Storage	1. Initial measure: Spec: refer Initial spec. 2. Unpowered: 500hours @ $T= -30^{\circ}\text{C}$. 3. Measurement at 24 ± 2 hours after test.	No Visible Damage. Fulfill the electrical specification.	MIL-STD-202 108
Solderability (SMD Bottom Side)	Dipping method: a. Temperature: $235 \pm 5^{\circ}\text{C}$ b. Dipping time: $3 \pm 0.5\text{s}$	The solder should cover over 95% of the critical area of bottom side.	IEC 60384-21/22 4.10
Soldering Heat Resistance (RSH)	Preheating temperature: $150 \pm 10^{\circ}\text{C}$. Preheating time: 1~2 min. Solder temperature: $260 \pm 5^{\circ}\text{C}$. Dipping time: $5 \pm 0.5\text{s}$	No Visible Damage.	IEC 60384-21/22 4.10
Vibration	5g's for 20 min., 12 cycles each of 3 orientations Note: Use 8"X5" PCB .031" thick 7 secure points on, one long side and 2 secure points at corners of opposite sides. Parts mounted within 2" from any secure point. Test from 10-2000 Hz.	No Visible Damage.	MIL-STD-202 Method 204
Mechanical Shock	Three shocks in each direction shall be applied along the three mutually perpendicular axes of the test specimen (18 shocks) Peak value: 1,500g's Duration: 0.5ms Velocity change: 15.4 ft/s Waveform: Half-sine	No Visible Damage.	MIL-STD-202 Method 213
Humidity Bias	1. Humidity: 85% R.H., Temperature: $85 \pm 2^{\circ}\text{C}$. 2. Time: 500 ± 24 hours. 3. Measurement at 24 ± 2 hrs after test condition.	No Visible Damage. Fulfill the electrical specification.	MIL-STD-202 Method 106

<p>Board Flex (SMD)</p>	<p>1. Mounting method: IR-Reflow. PCB Size (L:100 × W:40 × T:1.6mm) 2. Apply the load in direction of the arrow until bending reaches 2 mm.</p>	<p>No Visible Damage.</p>	<p>AEC-Q200 005</p>
<p>Adhesion</p>	<p>Force of 1.8Kg for 60 seconds.</p>	<p>No Visible Damage Magnification of 20X or greater may be employed for inspection of the mechanical integrity of the device body terminals and body/terminal junction.</p>	<p>AEC-Q200 006</p>
<p>Physical Dimension</p>	<p>Any applicable method using x10 magnification, micrometers, calipers, gauges, contour projectors, or other measuring equipment, capable of determining the actual specimen dimensions.</p>	<p>In accordance with specification.</p>	<p>JESD22 JB100</p>

Revision History

Revision	Date	Content
1	2018/7/20	New issue