



TEST REPORT

Product : MINI PC
Model Name : F481
Report No. : PTC24022004703E-RF01

Prepared for

Shenzhen Dongfang Box Core Information Technology Co., Ltd
3rd Floor, Factory 01, New World Industrial City, Wanke City Community, Bantian Street,
Longgang District, Shenzhen

Prepared by

Precise Testing & Certification Co., Ltd
Building 1, No. 6, Tongxin Road, Dongcheng Street, Dongguan, Guangdong, China

TEL: +86-769-3880 8222

FAX: +86-769-3882 6111





1 Test Result Certification

Applicant's name : Shenzhen Dongfang Box Core Information Technology Co., Ltd
Address : 3rd Floor, Factory 01, New World Industrial City, Wanke City Community, Bantian Street, Longgang District, Shenzhen
Manufacture's name : Shenzhen Dongfang Box Core Information Technology Co., Ltd
Address : 3rd Floor, Factory 01, New World Industrial City, Wanke City Community, Bantian Street, Longgang District, Shenzhen
Product name : MINI PC
Model name : F481
Standards : GB/T 9410-2008; ANSI/IEEE Std 149-1979
Test Date : Mar. 22, 2024 to Mar. 25, 2024
Date of Issue : Mar. 29, 2024
Test Result : Pass

This device described above has been tested by PTC, and the test results show that the equipment under test (EUT) is in compliance with the GB/T 9410 and ANSI/IEEE Std 149 requirements. And it is applicable only to the tested sample identified in the report.

This report shall not be reproduced except in full, without the written approval of PTC, this document may be altered or revised by PTC, personal only, and shall be noted in the revision of the document.

Test Engineer:

Technical Manager:



Jack Zhou / Engineer

Simon Pu / Manager



Report No.: PTC24022004703E-RF01

Revision History of Report

Vision No.	Date	Revisions	Modifier
00	Mar. 29, 2024	Initial Issue	



Contents

1 Test Result Certification	2
2 Test Summary	5
3 Test Site.....	6
3.1 Test Facility.....	6
3.2 Measurement Uncertainty.....	6
3.3 List Of Test And Measurement Instruments	6
3.4 Test environmental.....	6
3.5 Test Setup.....	7
4 EUT Description.....	8
5 Test Data.....	9
5.1 Typical free space efficiency and gain	9
5.2 Typical free space radiation pattern	12
5.3 3D Pattern.....	15
6 EUT setup photo of free space OTA testing.....	18
7 EUT appearance	19



2 Test Summary

Name	Parameter	Method	Standard no.
Mobile communication antenna	Antenna gain	Generic specification for antennas used in the mobile communications	GB/T 9410-2008
	Radiation pattern		
Antenna	Radiation efficiency	IEEE Standard Test Procedures for Antennas	ANSI/IEEE Std 149-1979
	Gain and directivity		



3 Test Site

3.1 Test Facility

Name	Precise Testing & Certification Co., Ltd
Address	Building 1, No. 6, Tongxin Road, Dongcheng Street, Dongguan, Guangdong, China

3.2 Measurement Uncertainty

The uncertainty was calculated on the basis of the GUM published by ISO, using the inclusion factor of K=2 and the 95% confidence level to express the extended uncertainty.

Item	Uncertainty
Antenna gain	$\pm 0.68\text{dB}$
Radiation efficiency	$\pm 0.68\text{dB}$

3.3 List Of Test And Measurement Instruments

Name of Equipment	Manufacturer	Serial No.	Last Cal.	Calibration Interval
24 probe microwave chamber	YIHENG ELECTPONC	4*4*4	Jan. 10,2024	1 Year
Network Analyzer	E5071C	Agilent	Jan. 10,2024	1 Year
XH.PassiveTest 2.7.6	XH-IOT	/	/	/

3.4 Test environmental

Environment Parameter	Selected Values During the Testes	
Relative Humidity	45% to 55%	
Value	Temperature($^{\circ}\text{C}$)	Voltage(V)
NTNV	20 to 24	N/A

Note: NV: Normal Voltage; NT: Normal Temperature

3.5 Test Setup

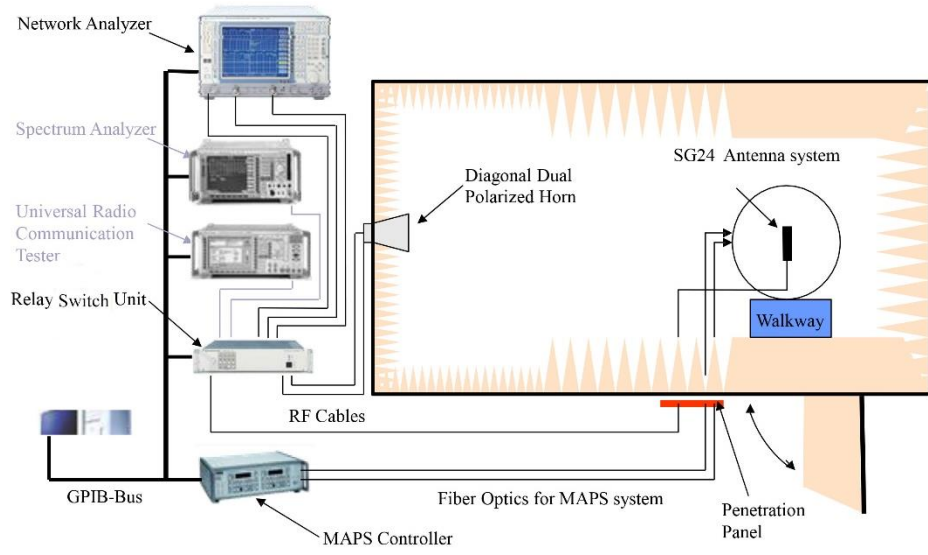



Report No.: PTC24022004703E-RF01

4 EUT Description

Product Name	MINI PC
Sample Model	F481
Size	/
Test Item	Antenna gain; Radiation pattern and efficiency
Antenna Type	FPC Antenna
Frequency Range	2400MHz-2500MHz 5100MHz-5900MHz



5 Test Data

5.1 Typical free space efficiency and gain

Test data For Band 2400 MHz to 2500MHz:

Frequency/MHz	Efficiency / dB	Efficiency / %	Max Gain/dBi	Avg Gain/dBi
2400	-8.32	14.72	0.79	-8.32
2410	-8.11	15.45	1.18	-8.11
2420	-7.99	15.89	1.68	-7.99
2430	-7.76	16.75	1.33	-7.76
2440	-7.69	17.02	1.17	-7.69
2450	-7.57	17.50	1.74	-7.57
2460	-7.36	18.37	1.81	-7.36
2470	-7.19	19.1	1.81	-7.19
2480	-7.18	19.14	2.32	-7.18
2490	-7.15	19.28	2.11	-7.15
2500	-7.15	19.28	1.63	-7.15



Test data For Band 5100 MHz to 5900MHz:

Frequency/MHz	Efficiency / dB	Efficiency / %	Max Gain/dBi	Avg Gain/dBi
5100	-9.15	12.16	-0.66	-9.15
5120	-9.43	11.4	-1.38	-9.43
5140	-9.61	10.94	-1.12	-9.61
5160	-9.46	11.32	-1.11	-9.46
5180	-9.92	10.19	-1.82	-9.92
5200	-10.01	9.98	-1.56	-10.01
5220	-10.07	9.84	-1.9	-10.07
5240	-10.23	9.48	-1.9	-10.23
5260	-10.41	9.1	-1.74	-10.41
5280	-10.23	9.48	-1.85	-10.23
5300	-10.16	9.64	-1.71	-10.16
5320	-10.1	9.77	-1.47	-10.1
5340	-9.83	10.4	-1.51	-9.83
5360	-9.78	10.52	-1.23	-9.78
5380	-9.44	11.38	-0.86	-9.44
5400	-9.23	11.94	-0.81	-9.23
5420	-8.96	12.71	-0.43	-8.96
5440	-8.73	13.4	-0.15	-8.73
5460	-8.11	15.45	0.14	-8.11
5480	-7.86	16.37	0.35	-7.86
5500	-7.59	17.42	0.73	-7.59
5520	-7.01	19.91	0.66	-7.01
5540	-6.77	21.04	1.16	-6.77
5560	-6.52	22.28	1.39	-6.52
5580	-6.16	24.21	1.33	-6.16
5600	-5.96	25.35	1.71	-5.96
5620	-5.79	26.36	1.67	-5.79
5640	-5.4	28.84	1.76	-5.4
5660	-5.31	29.44	1.87	-5.31
5680	-5.15	30.55	1.85	-5.15
5700	-4.98	31.77	1.96	-4.98
5720	-5.11	30.83	1.74	-5.11
5740	-5.04	31.33	1.83	-5.04
5760	-5.05	31.26	1.61	-5.05
5780	-5.12	30.76	1.43	-5.12
5800	-5.35	29.17	1.51	-5.35
5820	-5.13	30.69	1.59	-5.13
5840	-5.38	28.97	1.38	-5.38



Report No.: PTC24022004703E-RF01

5860	-5.39	28.91	1.78	-5.39
5880	-5.32	29.38	1.58	-5.32
5900	-5.53	27.99	1.18	-5.53

5.2 Typical free space radiation pattern

Test data For Band 2400 MHz to 2500MHz:

(1) X-Z Plane:

V Phi=0

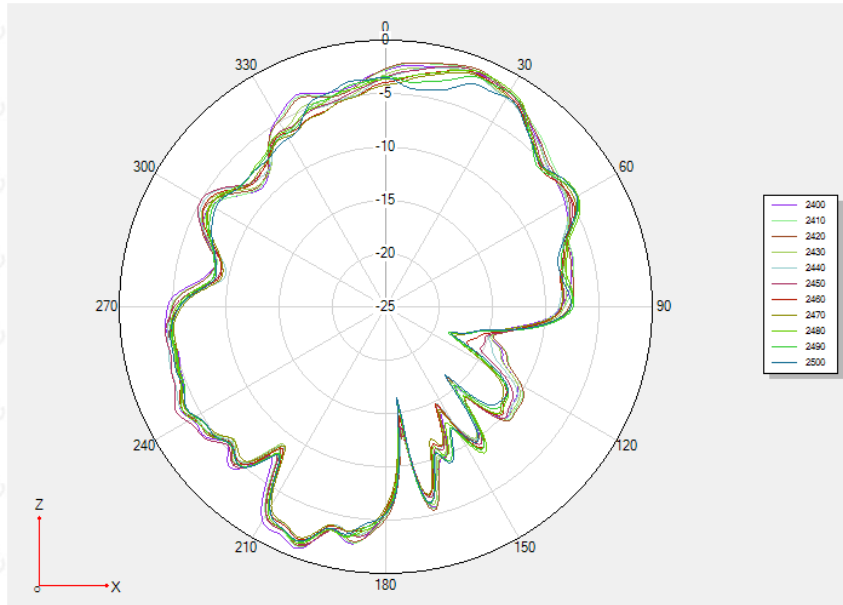

(2) Y-Z Plane:

V Phi=90

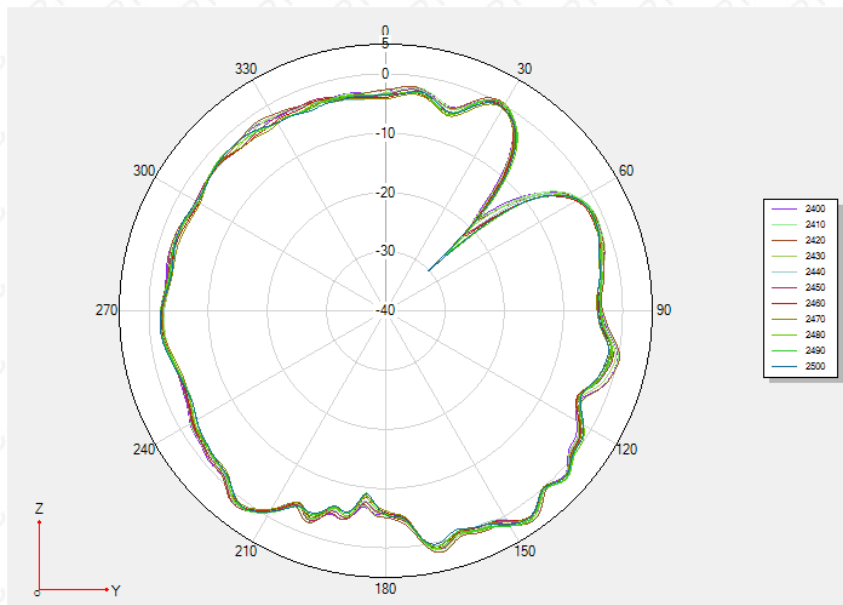



(3)X-Y Plane:

H Theta=90

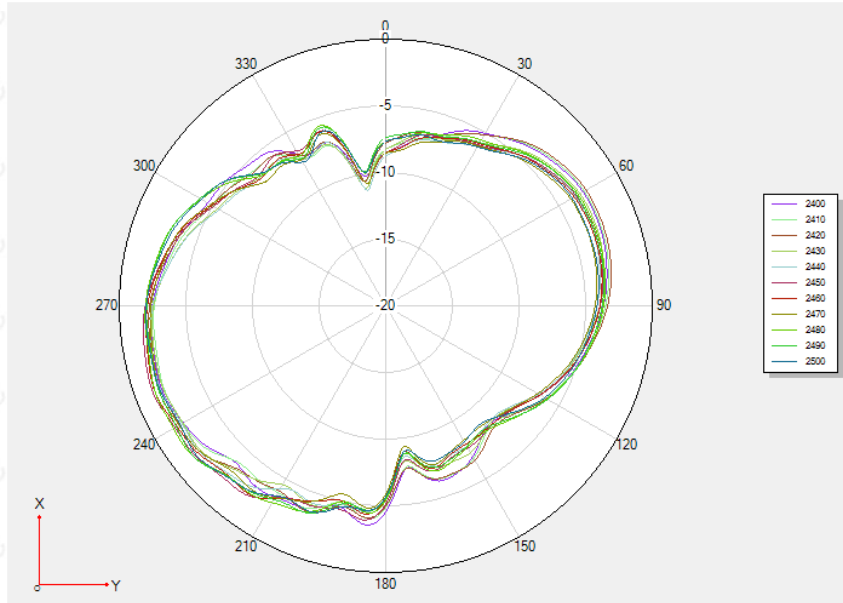

Test data For Band 5100 MHz to 5900MHz:

(1) X-Z Plane:

V Phi=0

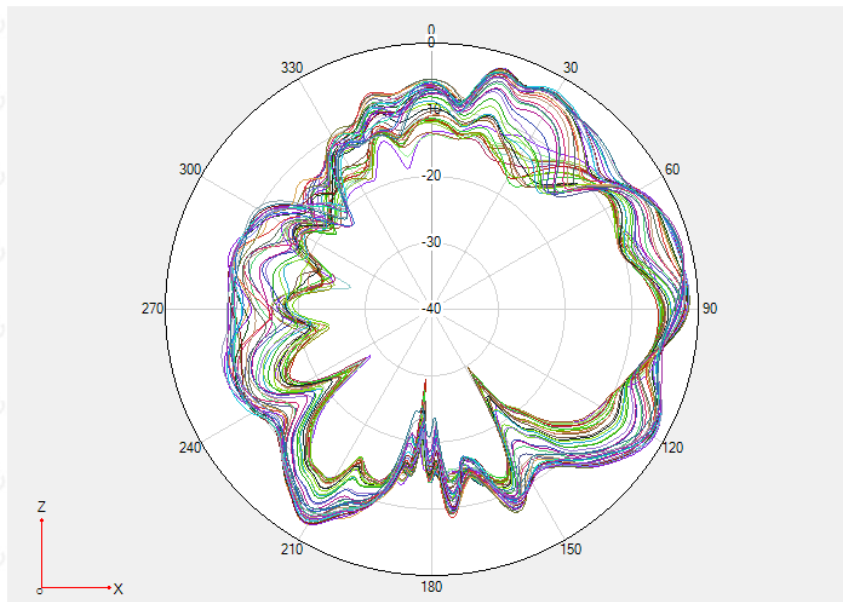



(2) Y-Z Plane:

V Phi=90

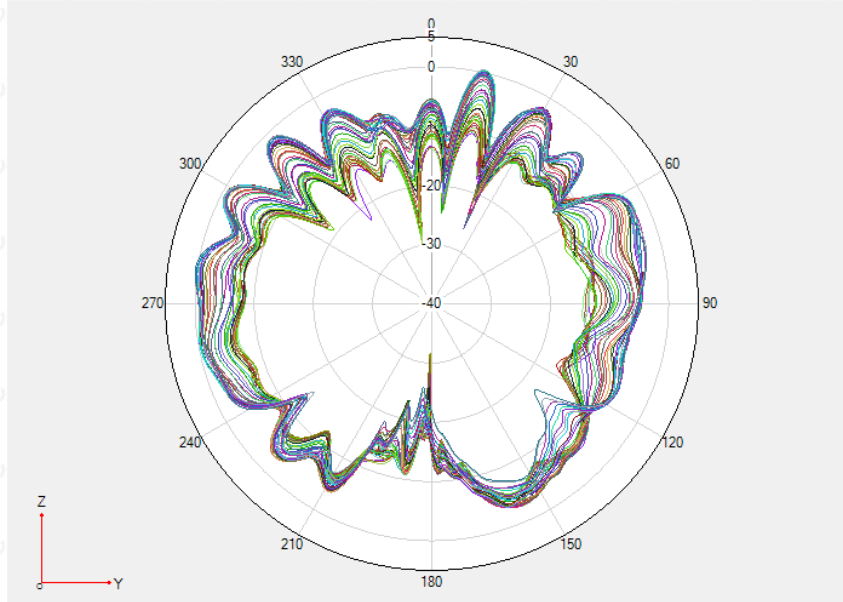

(3) X-Y Plane:

H Theta=90

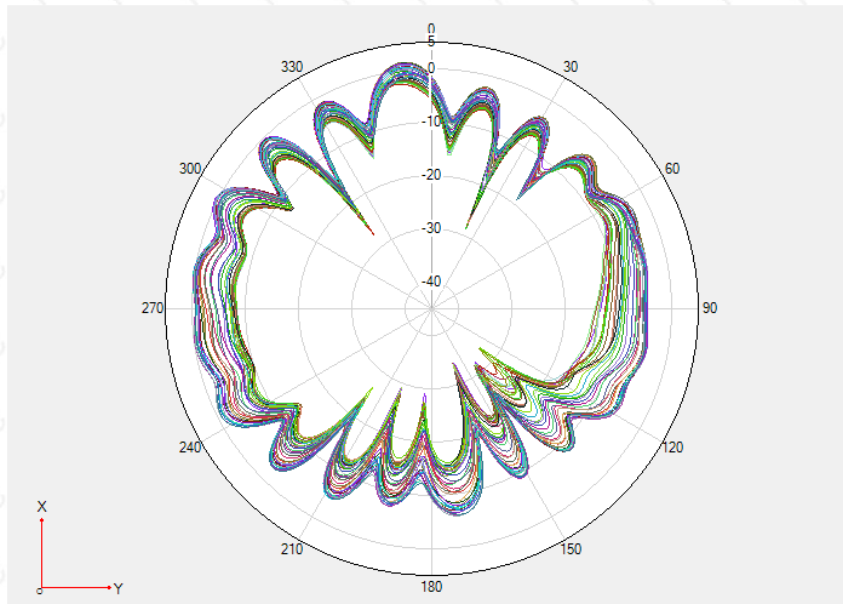

5.3 3D Pattern

Test data For Band 2400 MHz to 2500MHz:

3D Pattern for 2400MHz

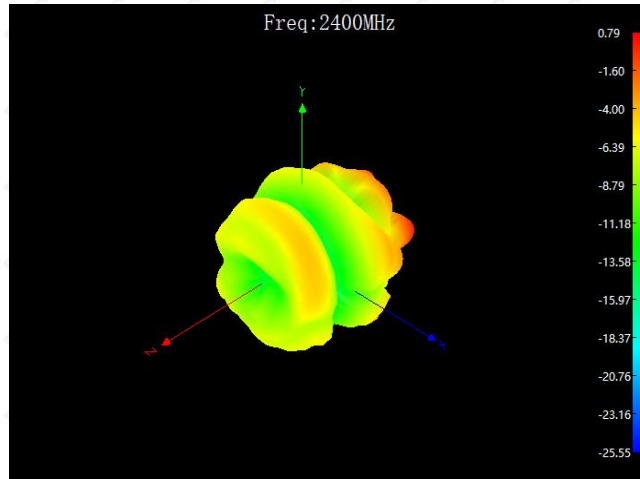

3D Pattern for 2450MHz

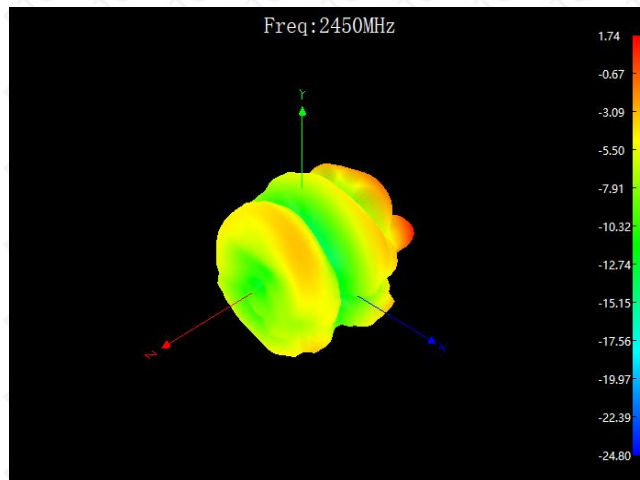



3D Pattern for 2500MHz

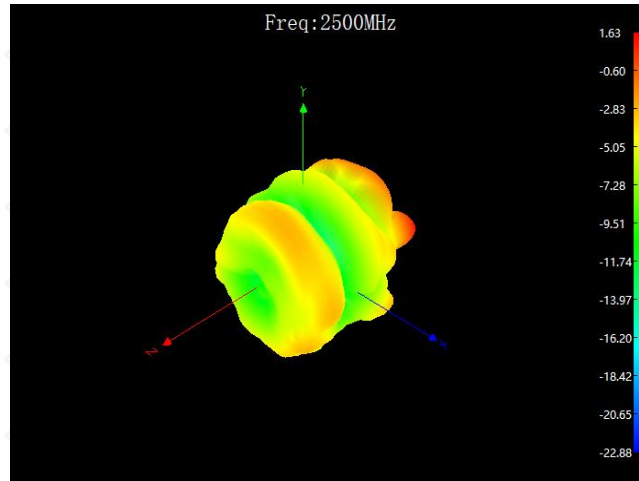

Test data For Band 5100 MHz to 5900MHz:

3D Pattern for 5100MHz

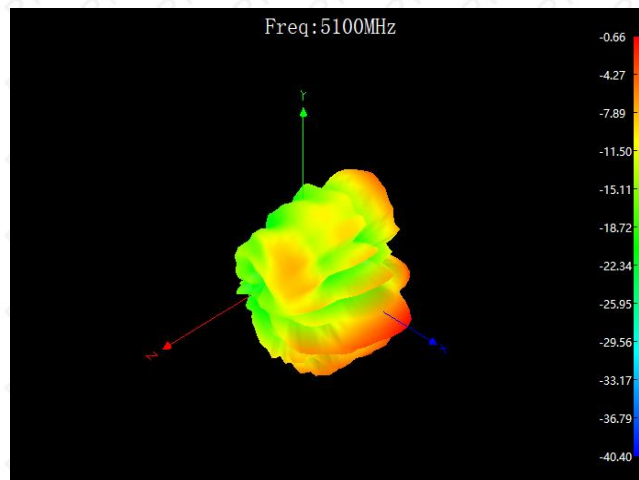



3D Pattern for 5500MHz

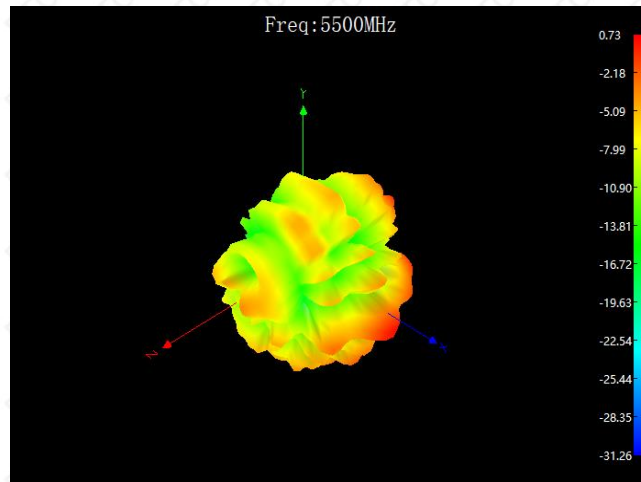

3D Pattern for 5900MHz

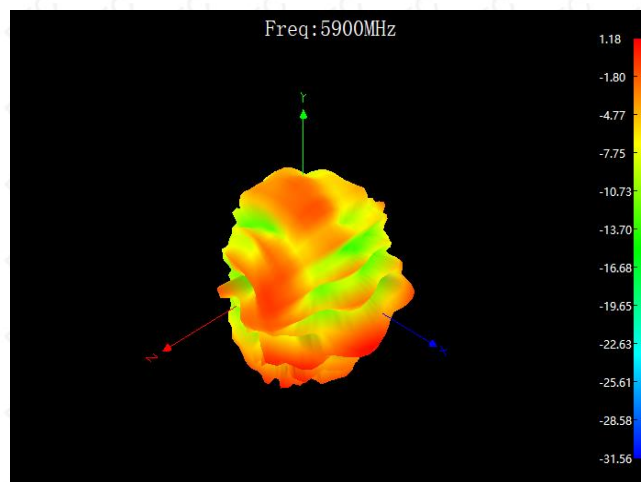

6 EUT setup photo of free space OTA testing

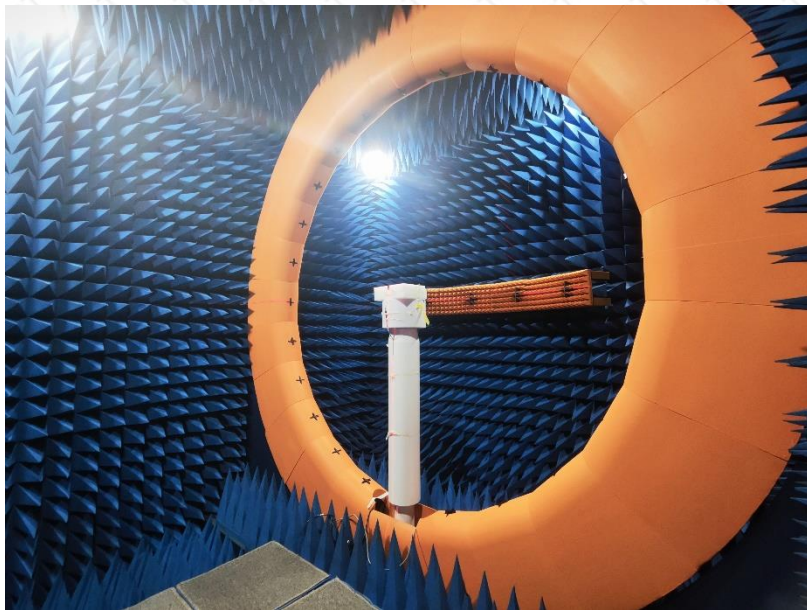
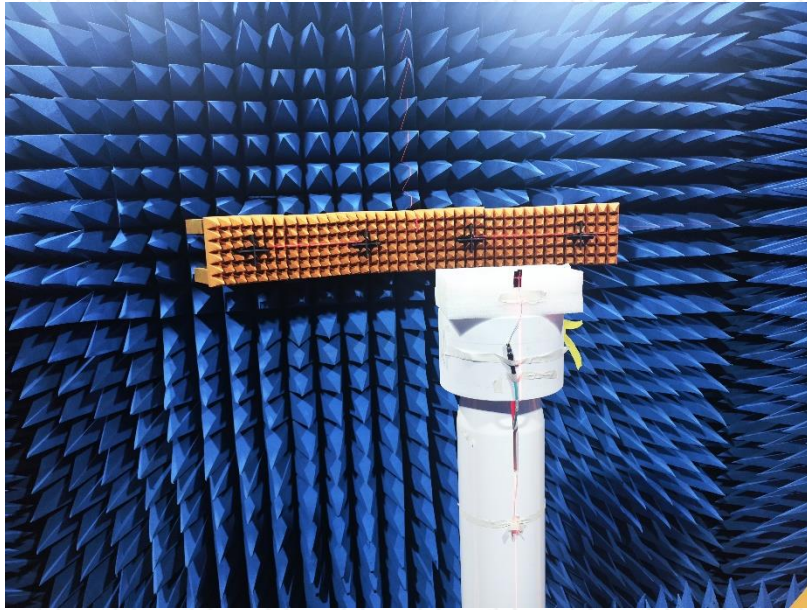

7 EUT appearance

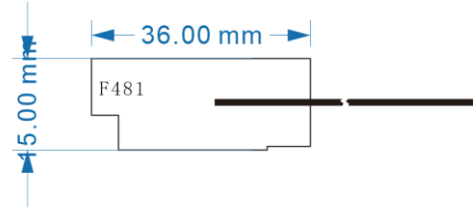
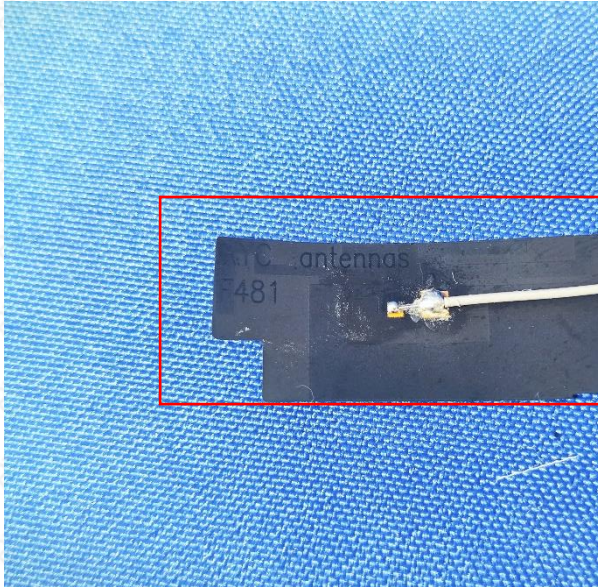

*****THE END REPORT*****