

Shenzhen Shenchao communication electronics Co., LTD

产品规格书

Product specification

客 户: Dongguan Yongzhixing electronic Technology Co., LTD
CUSTOMER:
客户案号:
CUSTOMER P/N:
本厂编号: SC2400D1(D1W2)-L300
OUR MODEL NO:
品名 / 规格: 2.4G-D1 off-white antenna
SPECIFICATIONS:
样品数: 0
QTY:
日期: 2024-3-6

Shenzhen Shenchao communication electronics Co., LTD			客户承认
工程 Engineering	品保 Quality	核准 Approved	签名（盖章）
谢工	黄工	高工	

1. Technical Specification

A. Electrical Characteristics	
Working Frequency Range	2400~2500MHz
S.W.R.	2400~2500MHz:<3.0
Antenna Gain(avg.)	2400~2500MHz: 3dBi±0.5dBi
Impedance	50ohm
B. Material	
brass	
C. Environmental	
Operation Temperature	-45℃~+85℃
Storage Temperature	-45℃~+85℃

2. Matching Circuits

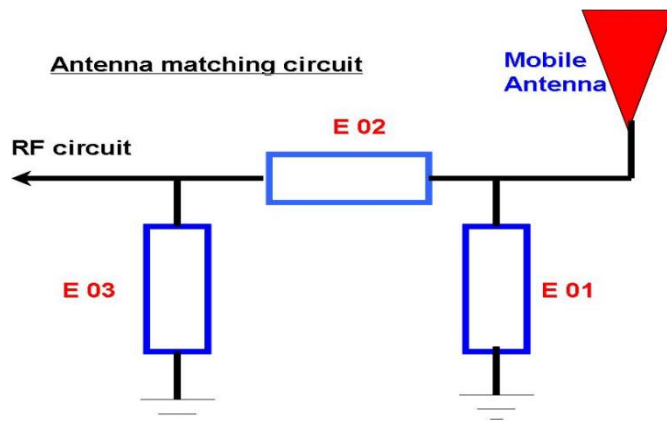

Element	Value	Vender
E1(0402)	OPEN	/
E2(0402)	SHORT	50 Ω
E3(0402)	OPEN	/

3. Curing antenna S11 Testing Result.

The S11 parameter was performed using a Agilent 8753D Network Analyzer and BEST'S test fixture that was using customer-providing device.

VSWR (Voltage standing wave ratio)

The Voltage Standing Wave Ratio (VSWR) is an indication of how good the impedance match is. VSWR is often abbreviated as SWR. If the transmission line and the antenna are not matched, the antenna will not accept all the power from the transmission line. The part it does not accept is reflected back and forth between the transmitter and the antenna. This sets up a fixed wave pattern along the line which we can measure and which is called the voltage standing wave ration(VSWR).The VSWR (ratio of maximum voltage to the minimum voltage along the line)expresses the degree of match between the transmission line and the antenna. When the VSWR is 1 to 1(1:1) the match is perfect and all the energy is transferred to the antenna prior to be radiated. When the VSWR is 1.5:1, 96% of the power reaches the antenna. By definition VSWR can never be less than 1.VSWR and reflected power are different ways of measuring and expressing the same thing. A high VSWR is indication that the signal is reflected prior to being radiated by the antenna.

驻波 VSWR

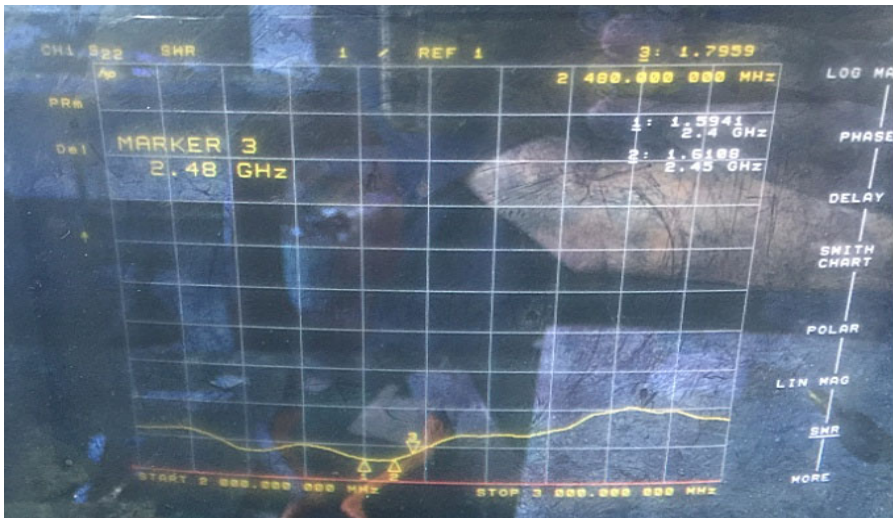

Marker	2400MHz	2450MHz	2500MHz
S.W.R	<3.0		

4.测试 3D 报告

频率: 2400MHZ 增益: 3.11dbi

2400.000MHz

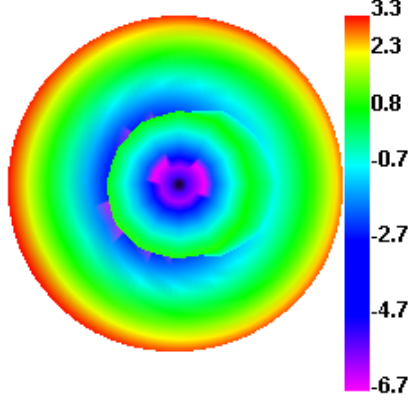

2400.000MHz H

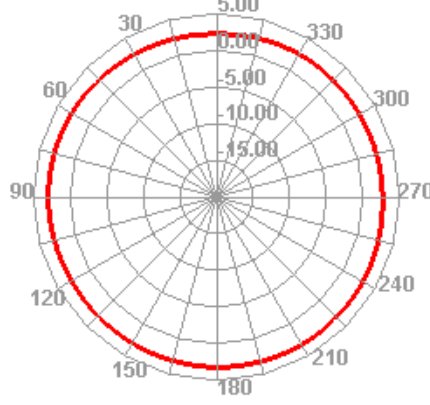

频率: 2450MHZ 增益: 3.52dbi

2450.000MHz

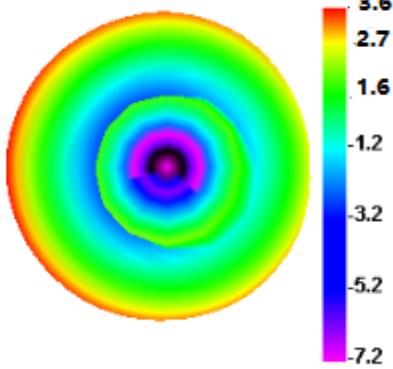

2450.000MHz H

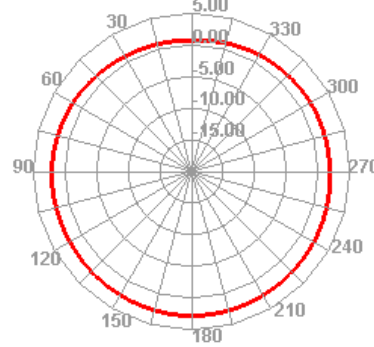

频率: 2500MHZ 增益: 3.84dbi

2500.000MHz

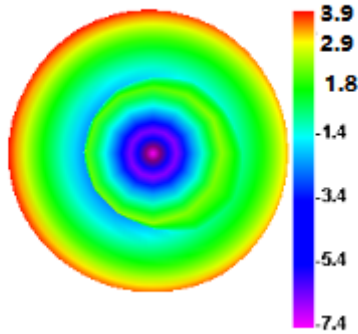

2500.000MHz H

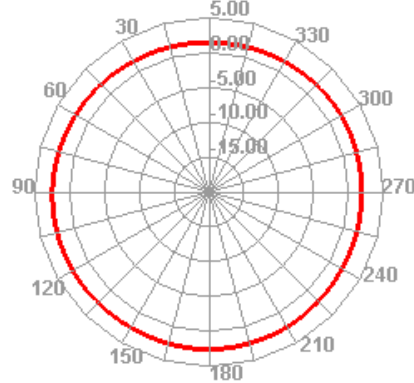

5. Test data

Passive Test For 2.4G												
Freq (MHz)	Effi (%)	Effi (dB)	Gain (dBi)	Gain (dBd)	UHS (%)	DHIS (%)	Max (dB)	Min (dB)	Directivity (dBi)	Beamwidth (3dB)	AttH (dB)	AttV (dB)
2400	54.36	-2.65	3.11	0.96	24.069	30.289	3.11	-17.66	5.76	0	45.51	45.06
2450	54.89	-2.6	3.52	1.37	25.656	29.237	3.52	-15.76	6.13	0	45.36	44.92
2500	58.4	-2.34	3.84	1.79	26.126	32.277	3.94	-15.6	6.28	0	45.93	45.51

6. Product appearance drawing

