

**Neideso Dash Cam  
N700**



**User Manual**

# CATALOG

Use reminder .....	2
Getting Started .....	5
What's in the box .....	7
Product Overview .....	8
Operation and Settings .....	9
How to install the main body .....	14
How to install the in-car rear cam .....	15
Setting Up Your Camera .....	17
Parking Mode ( Optional ) .....	29
Mobile phone connection APP .....	33
APP GPS video playback .....	40
Specifications .....	43
Warm Tips .....	45

## Use reminder

**1** Please read this instruction manual carefully before using the camera. It contains important information for your safety as well as operating and maintenance instructions.

**2** Follow all safety precautions in order to prevent damage due to improper use of the camera.

**3** You should not install this dash camera at a place that would obstruct or reduce a driver's view. Make sure your usage complies with pertinent vehicle codes of your state, province, territory or country.

**4** You should avoid extended exposure of the dash cam to direct sunlight or extreme temperatures (either high or low temperature) which tend to degrade or damage the unit and its normal functionality.

5. You should examine, check and verify the dash cam at least every 6 months, including the memory card, to ensure the video reception and recording are working properly. For each use, you should verify that the dash cam unit, the visible lights and the audible sounds are working normally.

6. Do not try to open the cover or try to repair it yourself. If the accessories for this device have any problem, please contact the seller for assistance.

7. Pay careful attention when cleaning the lens surface. Use a soft, moist cloth to clean the lens to avoid compromising video quality.

8. You should use the dash cam unit in the way it is intended. You use the dash cam unit in a way that would be illegal or that tends to physically damage the unit, or tend to cause danger to the safe operation of the vehicle or the occupants.

9. This device is intended to be used inside the vehicle only.

10. Do not expose this product to rain, moisture or water under any circumstances or it will result in external or internal damage.

11. Do not operate or install the camera while driving, or attempt to change any setting etc.

12. If any damage is caused by failure to follow the instructions, the warranty will be voided.

# Getting Started

- ① Before installation, please check the accessories carefully to ensure that the product and accessories are correct and complete.
- ② In order to ensure that the device is running well, please format the micro SD card first before use.
- ③ During installation, be sure not to insert the car key into the power supply, and do not insert or remove any machine accessories like microSD card or rear camera when the dash cam is powered on. These actions should be completed when power is turned off.
- ④ When the car key is plugged into the vehicle, the dash cam will automatically turn on. Please check whether the function of power on/off, the camera display is normal.



- ⑤ If you need to download the recording videos and images, please turn off the camera first before removing the microSD card.
- ⑥ You must use U3 high-speed card (recommended capacity 8GB-256GB), lower than U3 will cause problems like video stutter, black screen, and video cannot be recorded or cannot be played.
- ⑦ For some mobile phone models, if find that the TsCam APP cannot be connected to the preview, please turn on the airplane mode of the mobile phone and try.



## What's in the box?



1. HUPEJOS V80 Dash Cam



2. Rear camera with cable



3. Suction Cup Mount



4. Car Charger with Type C USB Cable



5. Car Wiring Tool



6. User Manual



7. Electrostatic Film for 3M Mount



8. 128GB SD Memory card



9. 3M Adhesive Mounts

## Product Overview



- ① Reset port
- ② Rear camera interface
- ③ TF card slot
- ④ Type C power port
- ⑤ Bracket
- ⑥ IR lamp
- ⑦ Right camera inside the car
- ⑧ Front camera
- ⑨ Left camera inside the car
- ⑩ Display
- ⑪ Working indicator light
- ⑫ Menu button
- ⑬ Up button
- ⑭ Power button
- ⑮ Down button
- ⑯ OK button

# Operation & Settings

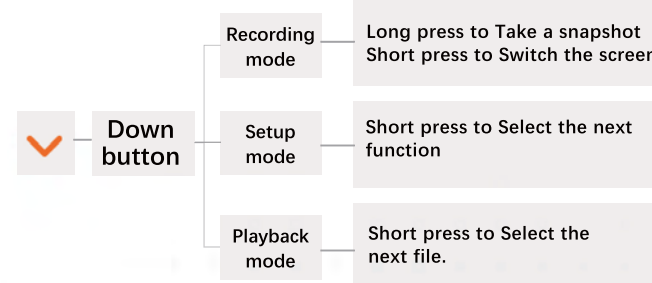
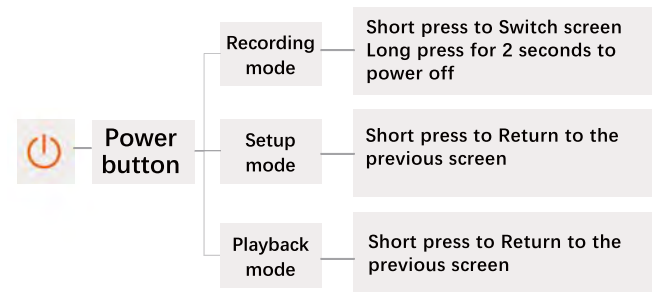
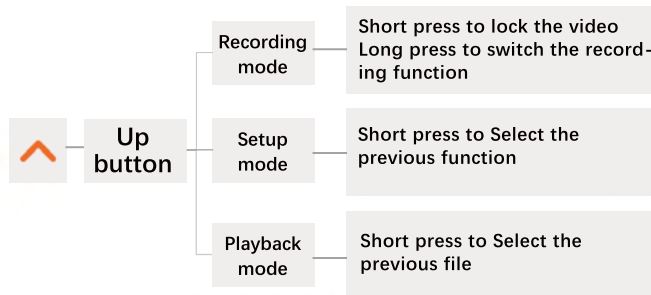
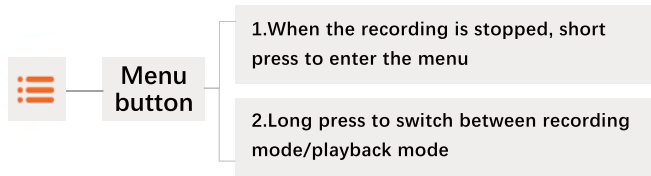

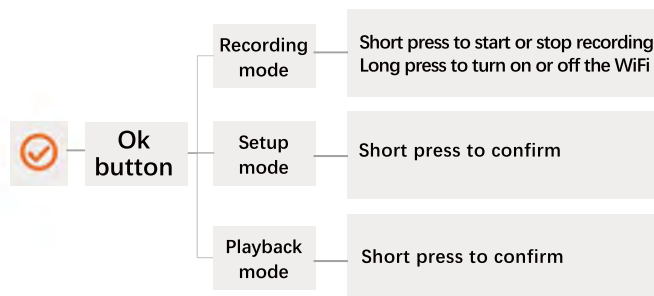

**Working indicator light**

**Blue indicator light**

1、 When recording, the blue light flashes

2、 Stop recording, the blue light is always on

## Insert the memory card

Push the TF memory card straight into the slot in the direction of the screen print until you hear a "click" sound.

Remove the card: Push the TF memory card forward, and the card will be removed when it is ejected.

Note: Removing the TF card in the video state may reduce the file and damage the life of the TF card, please turn off the dashcam first before inserting and removing the TF card

## SD card record files are described

SD Card name: Storage file

Event: Store video files that are locked in an emergency or manually

Normal: Store of conventional driving video files

Photo: Store snapshots

Parking: Store video files recorded by parking surveillance cameras

Share: For the reserved function, no files are stored

Secondary folder

A/B/C/D

A: Store video/pictures of front shots

B: Store video/pictures of left shots

C: Store video/pictures of right shots

D: Store the video/picture of the rear shot

## V80 Power Tools



1.Cig Charger

Note: It is best to use the power cord that comes with our products, or our professional hardwire kit.



2.Hardwire Kit with radar

(Required for Parking Mode. Prevents car battery drain)(Not included, purchased separately)

## How to install the main body

> Start the vehicle generator, and do a bench test before officially-installing the dash cam: connect the car charger to the Cigarette lighter port and the dash cam, connect the rear camera, and insert the MicroSD card to ensure that the dash cam can work normally.

> Find the right spot on the front windshield. Wipe the pre-installed location with a clean cloth.

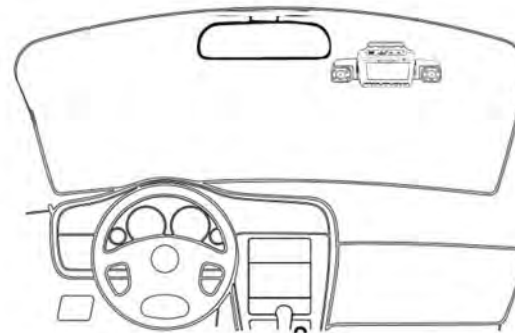



> Use the crowbar to run the power cable along the front windshield and the roof, and hide the cable on the A-pillar, so as not to block the driver's sight and cause danger.

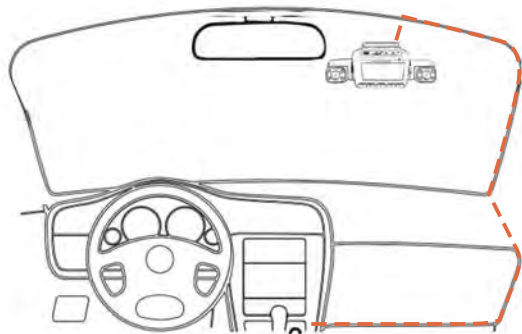

## How to install the in-car rear cam

NOTE: This rear camera is a special rear camera in the car, the effect is better if it is installed in the car and it is not waterproof. We recommend that you install it on the rear windshield of your car



> Use a clean cloth to wipe the rear windshield where the rear camera needs to be installed.

> Then peel off the electrostatic sticker from the cellophane, and transfer it to the place you want to stick it.

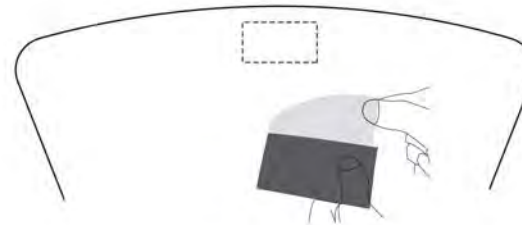

> Eliminate the air bubbles on the static stickers. It is recommended to install the back camera after standing still for half an hour to make the static stickers stronger

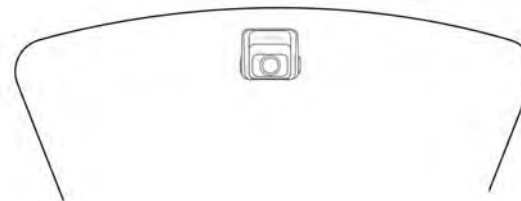

> Insert the power cord along the gaps between the front windshield and the ceiling, between the car body and the ceiling on the side of the passenger seat, between the rear seats and the ceiling.

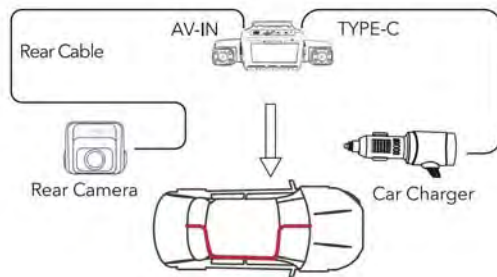

## Setting Up Your Camera

With your camera off, insert the card into the card slot with the label facing the back of your camera.

You can eject the card by pressing it into the slot with your fingernail.

Push the TF memory card straight into the slot in the direction of the screen print until you hear a "click" sound.

Remove the card: Push the TF memory card forward, and the card will be removed when it is ejected.

Note: Removing the TF card in the video state may reduce the file and damage the life of the TF card, please turn off the dashcam first before inserting and removing the TF card

## Powering on

With your camera off, insert the card into the card slot with the label facing the back of your camera.

You can eject the card by pressing it into the slot with your fingernail.

Short press  button to turn on your V80



# Powering off

Press and hold  button for 3 seconds to turn it of.



Function display of dash cam display Main Interface

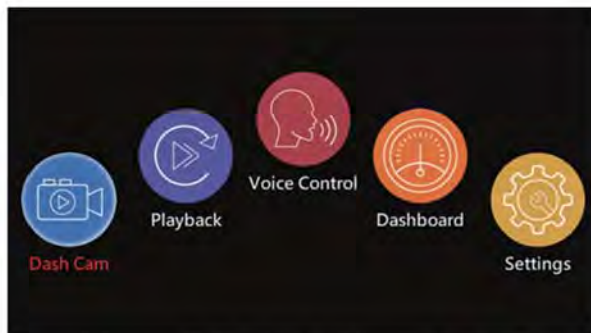

In video recording mode, short press the menu button to enter the main interface

Dash Cam:Driving recorder mode

Playback:Playback video or picture mode

Voice Control: Voice control function setting

Dashboard: Dashboard driving mode

Settings:System settings

# Dash Cam

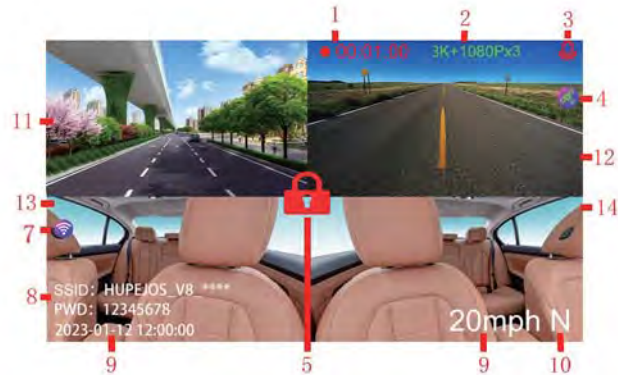



Number: Function description of the video recording interface

1 It disappears automatically when you stop recording.



2 Recording function:  
 When the rear camera is not connected, the resolution of the front channel is 4K; when the rear camera is connected, the resolution of the front channel is 3K or 2K  
 Front: 4K 3840X2160/3K 3200X1800/2K 2560X1440  
 Left: 1920X1080 Right: 1920X1080  
 Rear: 1920X1080

3 Recording function:  
 Indicates that the sound recording function is enabled

 Indicates that the sound recording function is disabled

4 GPS:  
 Indicates that the GPS is not located  
 Indicates that the GPS location is complete

5 Indicates that the recorded video is protected by a lock.

6 WiFi:  
 Indicates that Wi-Fi is not enabled  
 Indicates that Wi-Fi is enabled  
 Indicates that Wi-Fi is not enabled

7 SSID and Wi-Fi password

8 The current system time

9 After successful GPS positioning, the current vehicle speed will be displayed in real-time

10 After successful GPS positioning, it will display the current vehicle driving direction in real time

11 Front Video

12 Rear camera Video

13 Left Video

14 Right Video

Playback  
 Playback operations and settings  
 Button operation during playback

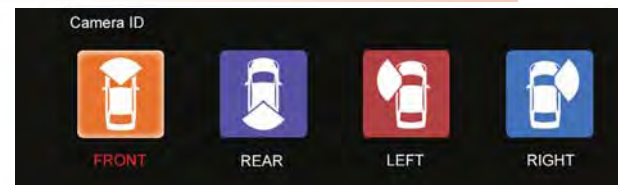







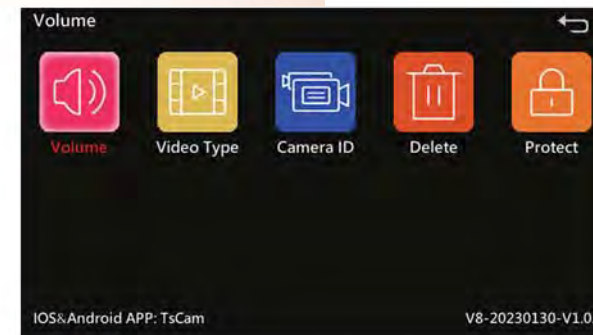

### Playback file preview screen - icon status.

- ① Video/picture switching button: Long press the menu button to switch from video file preview to picture file preview
- ② Menu: Press and hold the menu to enter the playback menu mode
- ③ Previous page: Short press the up button to view the previous video/picture.
- ④ Next page: Short press the down button to view the next video/picture.
- ⑤ Exit playback mode: Short press the power button or long press the menu button twice to return to video recording mode



## Playback settings



-  Volume: 0~ 100 [Default value: 50]
-  Video type: Normal/Parking mode/Emergency
-  Camera: A/B/C/D
-  Delete: Delete one or all of them
-  Protect: Protects selected files/deprotects selected files/Protects all files/deprotects all files

## Voice Control

Press the OK button to turn on or off the voice control function

-  Indicates that voice control is off
-  Indicates that voice control is on

After pressing the OK button to turn on the voice control, the voice command instructions will pop up, press any button to return to the main interface, say the following voice control commands to the machine, and the machine will respond with corresponding functions. Voice commands only support English wake-up, other languages are invalid.

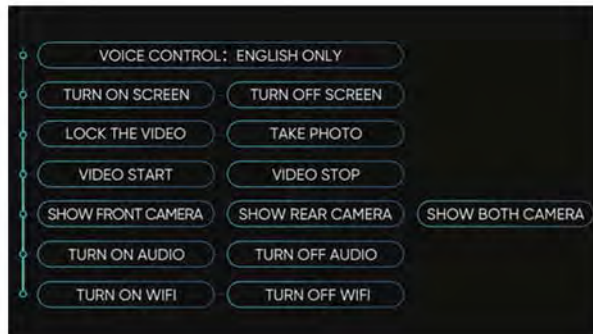

## Dashboard Dashboard driving mode

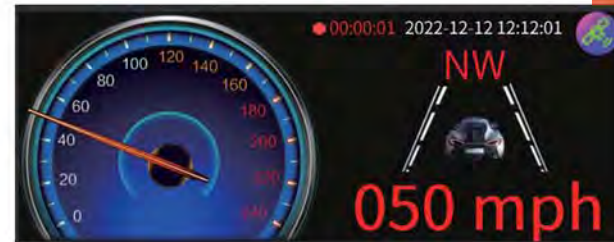

Driving safety tips: when driving speed exceeds 50mph or 80km/h speed will become red font tips driving safety. Special attention to tips: GPS positioning is not successful, the GPS icon flashing state, and the dashboard speed and direction is not functional. For example, if there is no GPS signal in the underground garage or the machine is working outdoors for the first time, the dashboard speed and bearing will not be functional within 2 minutes. Dashboard speed and bearing functions are functional only after successful GPS positioning.

## Settings:

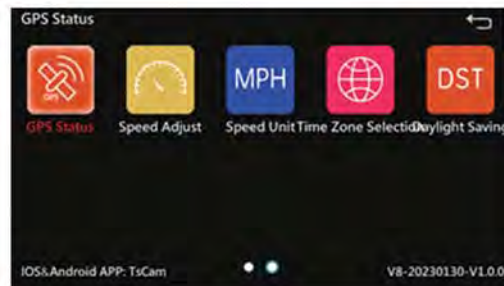
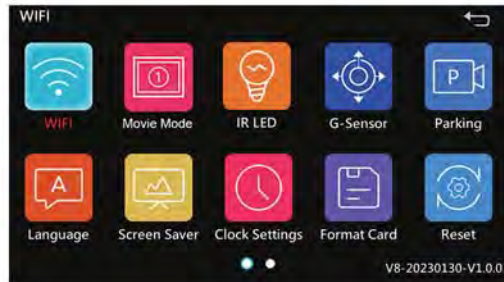

Wi-Fi: ON/OFF(default)Wi-Fifrequency:2.4G/5G(default)  
Note:if your phone does not support 5G,switch to the 2.4G option.



Movie Mode: 3K+1080Px3(default)/2K+1080Px3



IR Led: On/Off / Auto (Default)  
Note: When the scene is dark, it automatically opens, and when the scene is bright,it closes.



G-sensor: sensitivity setting, OFF/high/medium low (default)



Parking:When parking, if there is a collision when opening, the dashcam will automatically start recording for 60 seconds and then close it.High/medium/low sensitivity can beset



Language: English (Default) /Espanol/ Portugal/Pycknn简体中文/繁體中文/Deutsch/ Italia/Frangais/日本語/Korean/Turkiye/Thai/Nederland



Screen Saver:Off (default) You can set 1 minute to automatically close the screen and 3 minutes to automatically close the screen



Clock Settings: Set the date and time (theregional time will be automatically updated during GPS positioning)



Format card: select whether to format the memory and(Format the memory card before using the dash cam)



Reset Select: whether to restore factory Settings



GPS Status: GPS satellite CN value real-time screen



Speed Adjust +5mph(Default)and you can choose from +12 to- 12 Note:When the speed displayed by the dash cam deviates from the actual. it can be adjusted.



Speed unit: off/km/h/mph(default value)



Time zone selection:default- 5:00  
Warm tip:can be set according to the local time zone used by the user



Daylight Saving:On/Off(Default)

## Parking Mode ( Optional )

### PREPARE YOUR HARDWIRE KIT

Hardwire Kit is needed only when using Parking Mode.  
If Parking Mode is desired, contact to purchase.

### GETTING TO KNOW YOUR HARDWIRE KIT

Features:

- > Low Battery Voltage Protection
- > Multi Input Power
- > Universal Compatibility
- > Length: 11.5ft

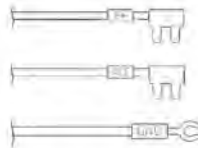

**⚠ WARNING:** Wrong connection may disable VoltageProtection and damage your car.

### INSTALL YOU HARDWIRE KIT

- |             |          |                                 |
|-------------|----------|---------------------------------|
| Red wire    | >ACC     | > Power only when car key is on |
| Yellow wire | >B+      | > Always has power              |
| Black wire  | > Ground | > Any grounded(neg) screw       |

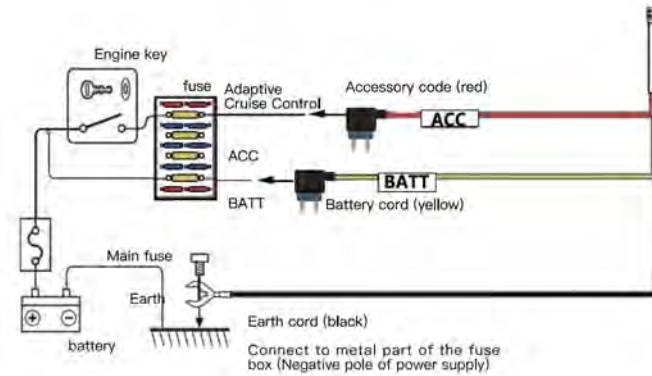

POP-UP: Fuse box panel is typically located driver side dash board.You could cut the head of wires and connect it to your fuse directly iffuses is small.

### LNSTALLATION NOTES

Connection	Driving	Parking	
ACC B+ Ground	ON	Parking Mode	✓
ACC No connection Ground	OFF	OFF	✗



ACC	ON	OFF	×
ACC			
Ground			
B+			
ACC	OFF	OFF	×
No connection			
No connection			
Any power	OFF	ON	×
Ground			
B+			
ACC	ON	OFF	×
Ground			

### PARTICULAR WRONG CONNECTION

Connection	Driving	Parking
B+		
B+	ON	Always On
Ground		

> The camera will run Parking Mode constantly, and your car battery will be drained under this connection

> Please check if your camera working after 15mins your car is off

(Because some cars have a delayed power-off function, 15 minutes later you can ensure that the ACC interface has been powered off)

> Please check if your camera working after 15mins your car is off (Because some cars have a delayed power-off function, 15 minutes later you can ensure that the ACC interface has been powered off)

### FAQ:

Q1: After installing the hardwire kit, it can enter the parking monitoring mode, but it cannot be turned on with the car starting, and the dash cam needs to be turned on manually, why?

A1: Because your hardwire kit's yellow wire is connected to the wrong place.

Q2: I have installed the hardwire kit, but the dash cam still prompts that the parking monitoring mode cannot be entered, why?

A2: The first reason is that your red and yellow wires are wired incorrectly. The second reason is that the red wire of the hardwire kit is broken and there is no power.

# Mobile phone connection APP

## 1. Download APP

APP Name: TsCam

Please scan the QR code for the relevant version below to download the app and install it.

- ① Search for the "Tscam" app in App Store/GooglePlay Store
- ② Search for "Tscam" in GooglePlay Store to find the app and then download and install it on your phone.



- ③ Search for the "Tscam" app in Amazon App Store



- ④ Other APP name: Tscams/Roadcam

If the "TsCam" APP cannot be downloaded, download other apps to use, scan the following picture QR code to download and use



Sometimes TsCam APP will be updated, if you can not download the "TsCam" APP, please contact us in time for after-sales support!

NOTE: The WiFi range of V80 is 6~7 meters from the dash cam. V80 Dash Cam is NOT a cloud dash cam, and you can't view your videos remotely away from more than 6~7 meters from your car. To utilize the WiFi feature, you must stay within the 6~7 meters range from your HUPEJOS V80 Dash Cam. Like your home WiFi, you don't get a WiFi signal outside your home, the same way the WiFi range for this tiny device is 6~7 meters.

Live View – Watch your dashcam's live video feed in about 10fts.

Video playback – Watch recorded videos stored on your dashcam on your smartphone. (The video and picture pixels of TsCam APP are compressed. So if you need to view clearer information, such as the license plate number, the picture or video can be downloaded through the app and played back online, or use the SD card to view it on your computer.)

# WiFi Connection

When WIFI is turned on, the display screen will display ID and ID password



- 1、 Please make sure the WiFi function on the machine is on
- 2、 Open the phone WiFi settings list, select the WiFi name (SSID:

HUPEJOS-V8-\*\*\*) on the machine, and enter the password (PWD: 12345678) to connect

- 3、 Open "TsCam"APP, click the "Connect" button and connect to use.

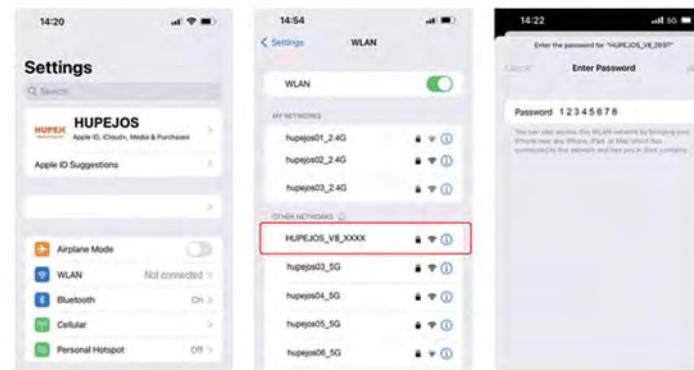

NOTE: Before connecting WiFi, please make sure the WiFi function of your smartphone is enabled.

If you forget the WiFi password, you can restore the default setting of the device, and the Wi-Fi password of the device will also be restored to the default password(12345678)

## APP Connection

After the WiFi connection is successful, click "connect" when opening the app, and then the app will automatically connect to the camera and display the current real-time recording the situation of the camera.

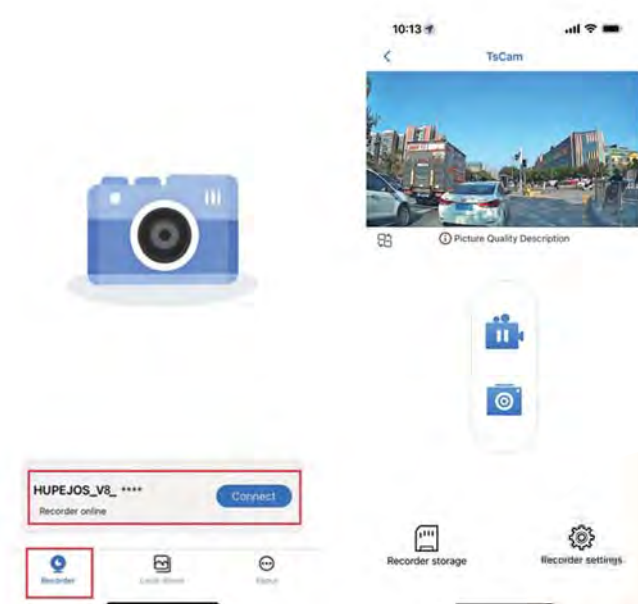

37

## App Operation

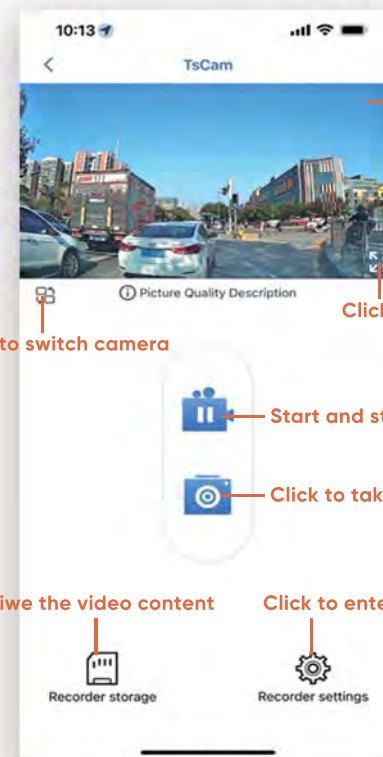

38

After entering the App's real-time preview, you can perform the following operations:

**Video preview:** After the app is successfully connected to the camera, enter the real-time preview page, click the full-screen icon or place the phone horizontally, and the real-time screen will automatically switch to the full-screen preview mode. Click the window switch icon to switch the front rear and cabin video windows, but only multi-channel dash cams can use this feature.

**Video playback:** The video and photo files recorded on the SD card can be viewed in the app, and the video can be played back after clicking the file.

**Video download:** You can select the video or picture you want to download in the SD card browsing interface or in the video playback area. After downloading the video, if you play it in the local file of the app interface.



## APP GPS video playback

- ①Open the APP and download the video to the local album.
- ②Select Native Album and Looping Video.
- ③Click Play video to view the track of the video.

Note: Android system must close the Wi-Fi connection between the phone and the local machine to see the playing tracks on the APP, otherwise, the phone can't access the Internet. iOS system doesn't need to.



## PC GPS video playback GPS function

- ①Video interface indicates  that the GPS is not positioned, Flashing status  means the GPS positioning is successful, No flashing.
- ②The system time will be synchronized after successful positioning (according to the time zone time set in the menu)
- ③In the "GPS status" of the general settings, you can view the real-time GPS CN value

## Install GXPlayer player

- 1、MAC system computer: Search "GXPlayer" on the application market of Apple computer to install it.
- 2、Windows system computer: the installation method is as follows.

Windows systems, you can automatically generate the GXPlayer installation file from the memory card used in V8 Dash Cam, find GXplayer in the file, and click download, and install GXplayer player to use.

Installing a GPS Player:    
Open after the installation is complete:

41

## Use GXPlayer

- Import the video file after GPS positioning (Figure1, number 1) ;  
Show track of travel (Figure1, number 2) ;  
Show the position in the process of driving (Figure1, number 3)  
The real-time speed (Figure1, number 4)  
General Settings (Figure1, number 5. The Figure 2 menu Settings feature will appear)



42

## Specifications

NO.name	Description
1.Resolution Video resolution	Front:4K 3840X2160/3K 3200X1800/2K 2560X1440 Left/Right:1920X1080, Rear camera:1920X1080
2.Audio and video formats	H.265 format
3.File format Image	Image: JPEG Video: mp4
4.Seamless Video	Support
5.Power failure file ecovery function	Support
6.Year/month/day/hour	Support
7.SD Card	Supports up to 256G Note: The SD card must be formatted on the machine before it can be used for the first time.

NO.name	Description
8.Multi-language support	English /Español / Portuguêse / Russian/ 简体中文 / 繁體中文/ Deutsch / Italiano/ Français / 日本語/한국어/ Türkiye /Nederlands
9.WIFI APP	Support
10.Lens	6G F/NO 1.8
11.DDR	DDR3 4G
12.Battery	None
13.Display resolution	854*480
14.SENSOR	4 megapixels
15.Lens angle	150 degrees
16.Speaker specifications	8R 1.5W
17.G-SENSOR	Three-axis gravity sensor
18.IR infrared fill light	8pcs 940
19.Operating voltage	5V 2.5A
20.Static current	20uA
21.Operating temperature	-30 degrees +60 degrees

## Warm Tips

1. The dash cam supports standard Micro SD cards.
2. Please use memory cards with the 32G(MINIMUM)-256G (MAXIMUM) of Class 10, U3(UHS-1) Speed or above.  
We recommend using Class 10, U3 of SAMSUNG or LEXAR High Endurance Micro SD cards.
3. When you insert a new card into the machine, please format the card on the Dash Cam before you use it. You can find the Format option on the menu of Dash Cam.
4. On the 1st and 15th of every month, after the machine is started up, there will be a prompt for formatting. This is just a prompt, and it doesn't matter if the user does not format it. Please don't worry about the machine formatting automatically.
5. Temperature protection: In the case of abnormal high temperature, it will automatically turn off WiFi and automatically turn off the device
6. Automatic resolution switching function: when the rear camera is not connected, the front resolution will automatically switch to 4K, and when the rear camera is connected, the front

resolution will be 2K or 3K

7. WiFi is turned off by default every time you turn it on. When you need to use it, please press and hold the OK button to turn it on or enter the settings to turn on the WiFi function
8. The memory card may become damaged or deteriorated after repeated cycles of overwriting, and this may affect its ability to save video and image files. after repeated cycles of overwriting, and this may affect its ability to save video and image files.

## Maintenance

### MAINTAIN YOUR CAMERA

Do not directly plug and unplug the cable or MicroSD card, except when the camera is turned off.

We do not encourage you to connect your camera with other hardware kit, but if you insist to do this, please have a look of those lower than 6V and higher than 2.5A.

It is normal for the camera to be warm during operation. Excessive exposure to heat from the sun may cause damage that isn't covered under the 1 year warranty.



# Trouble Shooting

## WIFI CONNECTION GOES WRONNG

### Connection Prepare

- > Mobile data/VPN is off
- > 16 ft less close to your V80
- > Only allowed 1 device connection

### Connection Notice

- > WiFi password: 12345678

## Won't enter Parking Mode

- > Hardwire kit needed
- > The screen prompts "ACC disconnected" when trying to enter Parking Mode
- > Blue light on + Red light flash

## Camera always on after Car turned down

- > Wrong connection of Red wire and Yellow wire
- > Please connect red wire with ignition fuse

## over Heat

- > Camera should stay between -22°F-144°

## FRECEIVED DEAD CAMERA ?

Use USB cable to connect your camera with computer and check if the screen turn on

> If not, please unplug MicroSD card and use a pin and press the Reset button at the bottom of camera

> Reconnect your camera and press 

## ULTIMATE SOLUTION

> Make sure you are using the original car charger that comes with the package. If not, please replace.

> Remove the rear camera, MicroSD card, and then put them back into the dash cam in sequence. Check whether the short circuit of the accessories causes the dash cam to fail to work normally.

> Check your MicroSD card is U3 Class10, if not, please change to one that is U3 Class10.

> If not, please use your personal USB charge and check again. - Check if the car charger is short-circuited and the dash cam can not work normally.

> Please download our latest firmware to upgrade your dash cam.

> If the methods above don't solve your problem, feel free to contact HUPEJOS and please leave your contact information and current address which may be needed if a replacement is warranted. This solution could be dealing with multiple problems > Won't turn on > Restart itself > MicroSD card error

> Can't auto recover > Can't playback

## After-sales Service Support

### Warranty:

The HUPEJOS Dash Cam comes with a full 12-month warranty. you can extend the warranty to 18 months.

### Support:

If you have any questions regarding your product, please do not hesitate to contact us via Amazon or drop us an email at HUPEJOS@gmail.com. These are typically answered within 12-24 hours.

### Your opinion matters:

HUPEJOS is firmly committed to always improving our products and services. and user experience. if you have any thoughts on how we can do even better, we welcome your constructive feedback and suggestions.

## THANK YOU FOR CHOOSING HUPEJOS®

### About HUPEJOS Dash Cam

We are a well-established manufacturer that specializes in providing smart car electronics & visual perceptual solutions for car lovers.

As a Dash Cam supplier, we are passionate about what we do. Every customer is important and unique - and we know they always expect the best from us. Providing our customers with a satisfying shopping experience includes not only offering the best prices with a guarantee, but also a wonderful warranty and the highest level of pre and post-sales customer service.

### Email Service:

hupejos@gmail.com

Email our customer service and we will answer any of your questions/concerns. We offer 7\*24 hours of technical support.

**Warning:**

Changes or modifications to this unit not expressly approved by the party responsible for compliance could void the user's authority to operate the equipment.

**NOTE:**

This device complies with part 15 of the FCC Rules. Operation is subject to the following two conditions: (1) This device may not cause harmful interference, and (2) this device must accept any interference received, including interference that may cause undesired operation.

**FCC Statement:**

This equipment has been tested and found to comply with the limits for a Class B digital device, pursuant to part 15 of the FCC Rules. These limits are designed to provide reasonable protection against harmful interference in a residential installation. This equipment generates, uses and can radiate radio frequency energy and, if not installed and used in accordance with the instructions, may cause harmful interference to radio communications. However, there is no guarantee that interference will not occur in a particular installation. If this equipment does cause harmful

## THANK YOU FOR CHOOSING HUPEJOS®

### About HUPEJOS Dash Cam

interference to radio or television reception, which can be determined by turning the equipment off and on, the user is encouraged to try to correct the interference by one or more of the following measures:

- Reorient or relocate the receiving antenna.
- Increase the separation between the equipment and receiver.
- Connect the equipment into an outlet on a circuit different from that to which the receiver is connected.
- Consult the dealer or an experienced radio/TV technician for help.

The equipment complies with FCC Radiation exposure limit set forth for uncontrolled environment. This equipment should be installed and operated with minimum distance 20cm between the radiator and your body.