

# PROJECTOR × **whaleos**

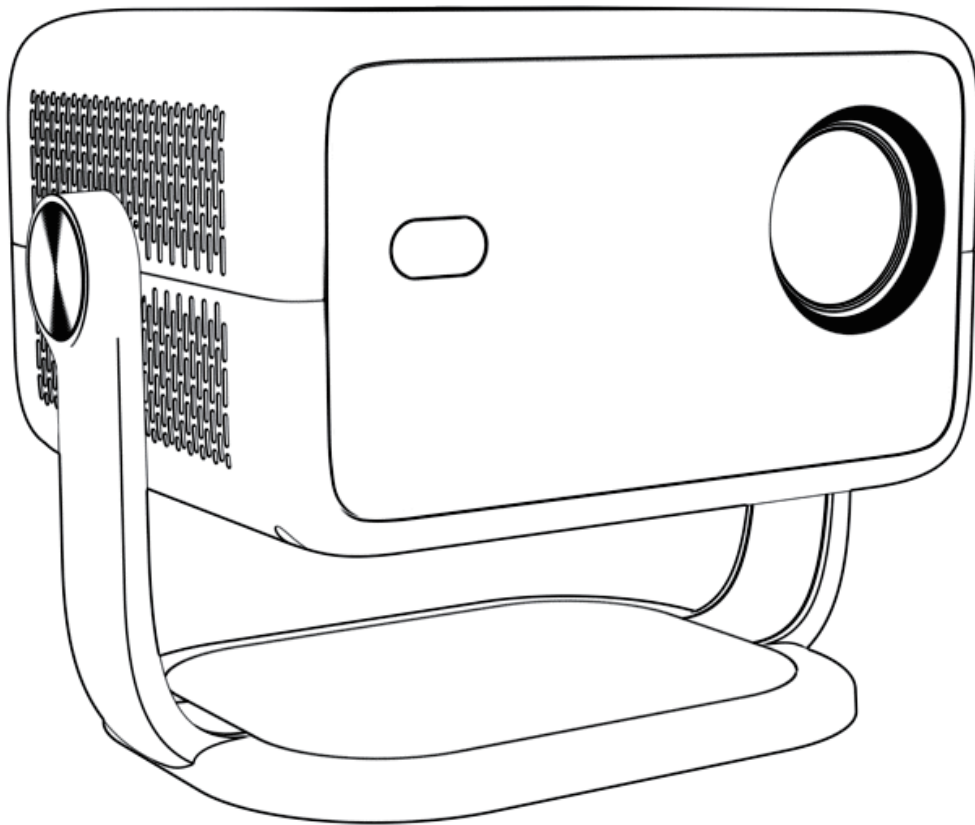

## User Manual

**NETFLIX**

 **YouTube**

 **Disney+**

 **prime video**

# Safety Instructions

Read all instructions before you use this device. Do not make any changes or create settings that are not described in this manual. If physical damage, loss of data or damage is caused by failure to follow instructions, the warranty does not apply.

1. To reduce the risk of fire or electric shock, do not expose the device to rain or moisture. Objects filled with liquids, such as vases, should not be placed on this device.
2. Do not place this device on soft surfaces such as tablecloths or carpets, otherwise the device could be a fire hazard.
3. Do not place this device in areas susceptible to excessive dust and dirt or near any appliance generating a strong magnetic field.
4. To prevent overheating, do not block or clog the ventilation holes.
5. Never place this device in a confined space. Always leave enough space around this device for ventilation.
6. Protect this device from overexposure to direct sunlight, heat, large temperature fluctuations and moisture. Avoid extreme temperatures.
7. When this device is running for a long period of time, the surface may become hot. Shut it down immediately and unplug the charger. Resume operation after this device has cooled down.
8. Always handle this device with care. Avoid touching the lens. Do not allow children to handle the device without supervision.
9. Use attachments or accessories specified by the manufacturer only.
10. Avoid extreme vibration as it may damage the internal components.

# Package List

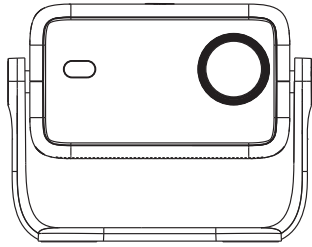

Projector × 1

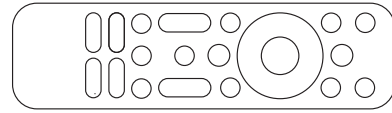

Remote Control × 1  
(Batteries are not included)

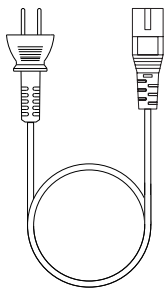

Power Cable × 1

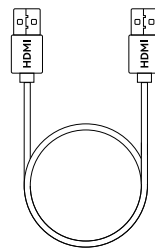

HDMI Cable × 1



Projector User Manual × 1

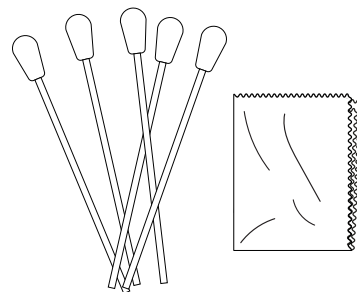

Clean Tool × 1

# Overview

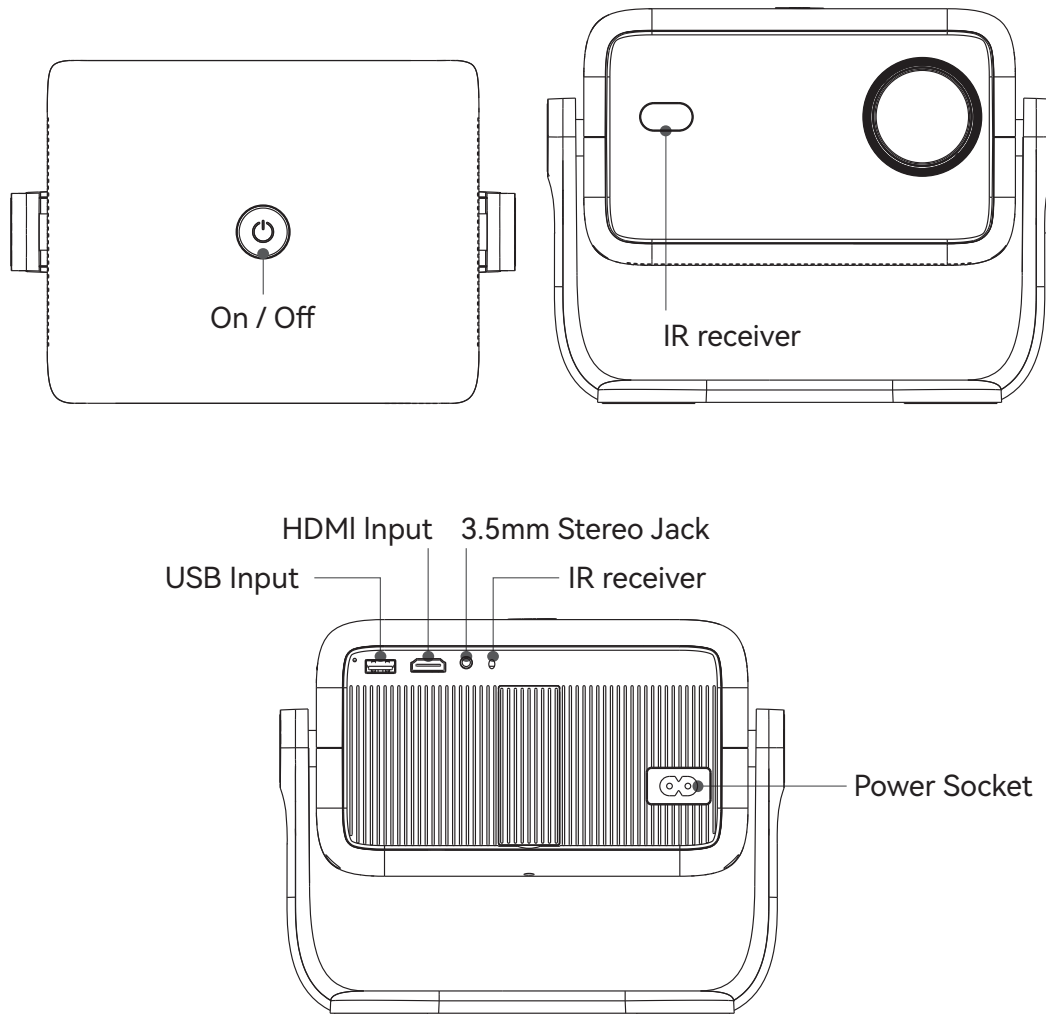

## Tips:

### 1. Blurry Image

Click Setting icon on the homepage - Setting - Lens - Autofocus Settings to adjust the image clarity.

Press the focus button on remote control to get the best clarity.

### 2. Mounting Hole

Adopting a single mounting hole dual-use design, the projector is compatible with the standard camera tripod and 1/4 inch screw projector tripod stand.

# Remote Control

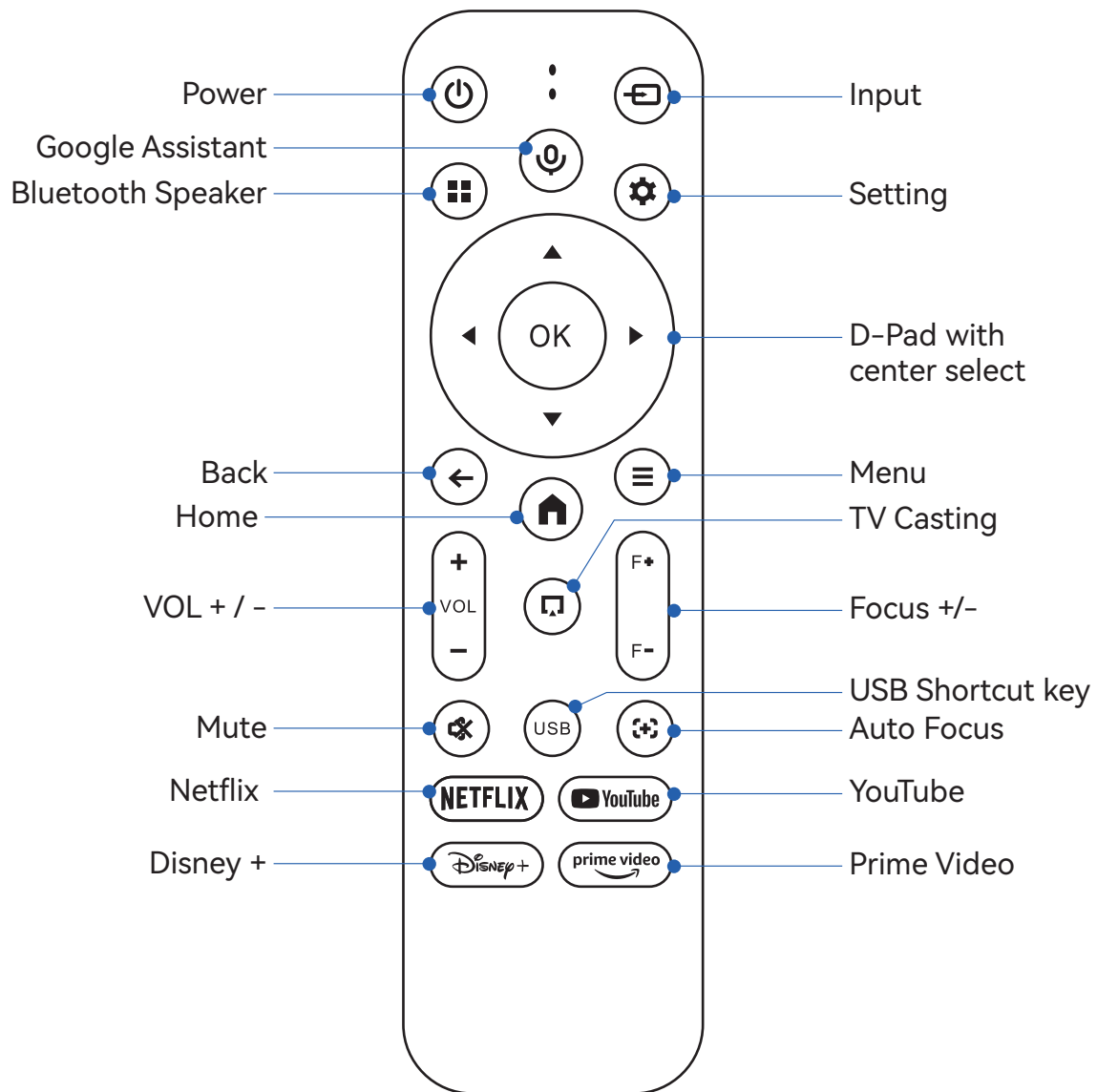

Note: the matching interface of Bluetooth remote control, Press "Voice input" button to bring up the matching guide.

**bluetooth remote controller pairing:**  
Please keep the Remote Controller close to the Projector, press and hold Left button and Right button for three seconds to pair.

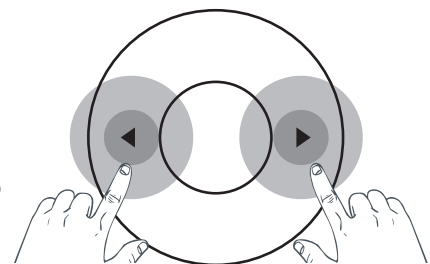

# Getting Started

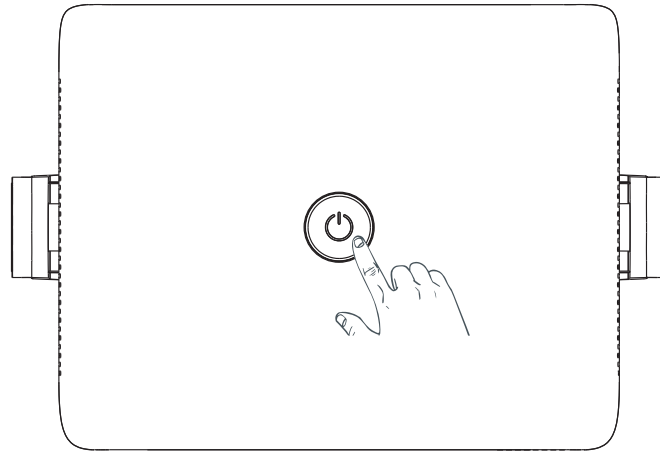

Plug the power cable to the projector.  
Press power button to turn on the projector.

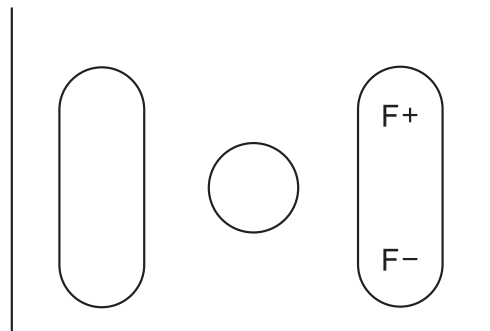

Use the manual focus by pressing the "Focus" button on the remote control.

**Tips:**

Make sure the projector is horizontal to the projector screen.

# Cleaning Method

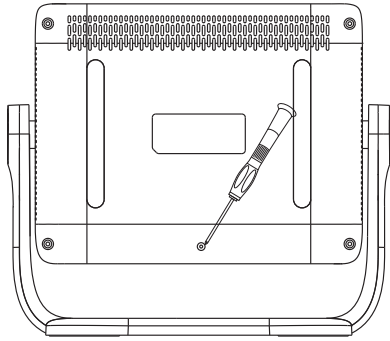

1. Get the screwdriver ready, unscrew the screws.

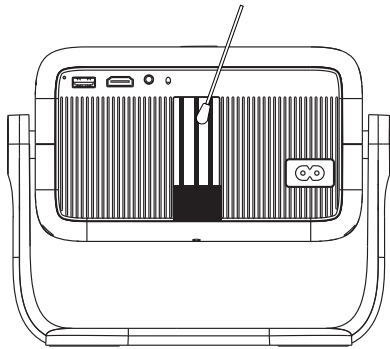

3. Clean the projector by the cotton swab.

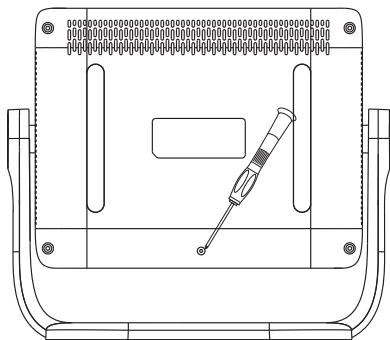

4. Reinstall the bottom cover after cleaning.

# Network Setting

⚙️ Click Setting icon on the homepage - Setting - Wireless and Network - Wired or Wifi - Connect to network > Choose the network and type the password that you want to connect to.

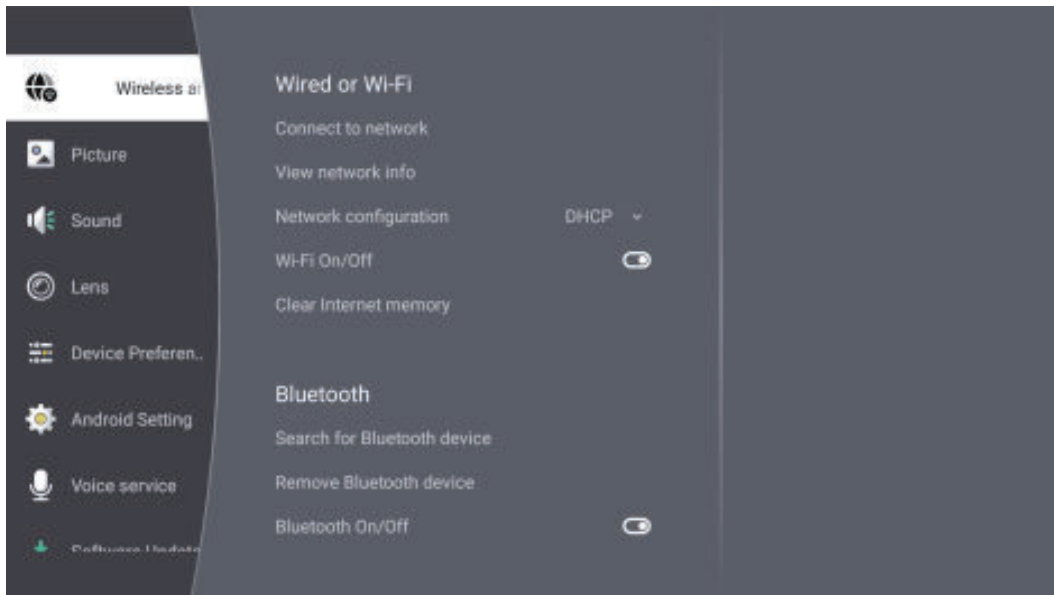

# Bluetooth Setting

⚙️ Click Setting icon on the homepage - Setting - Wireless and Network - Bluetooth - Search for Bluetooth device > Click search and pair the device that you want to connect to.

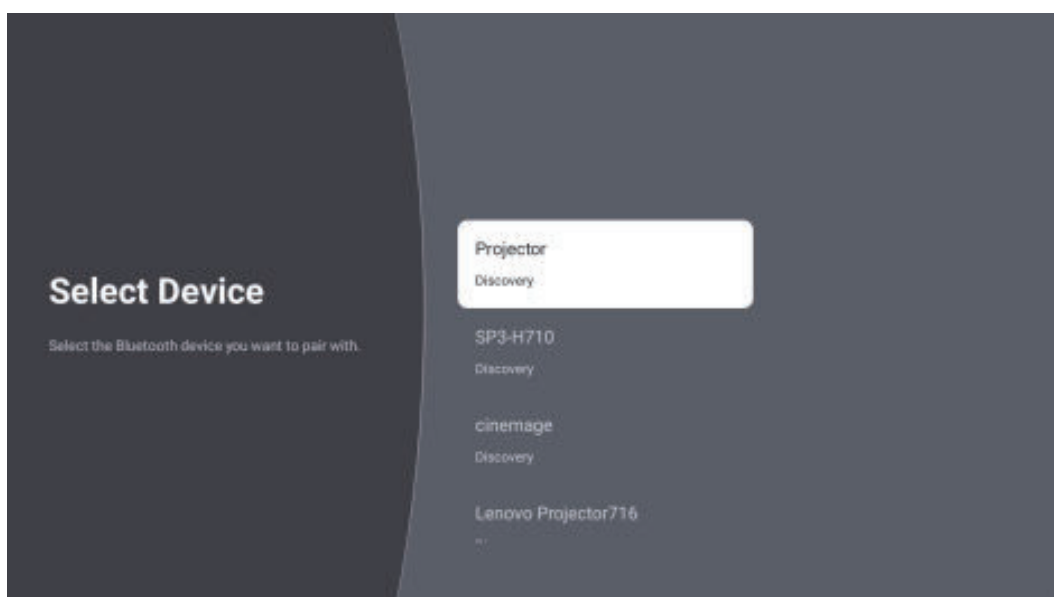



## CEC Setting

⚙️ Click Setting icon on the homepage – Setting – Wireless and Network – HDMI CEC – CEC > Enable CEC, CEC devices such as TV sticks can be controlled remotely with remote control.

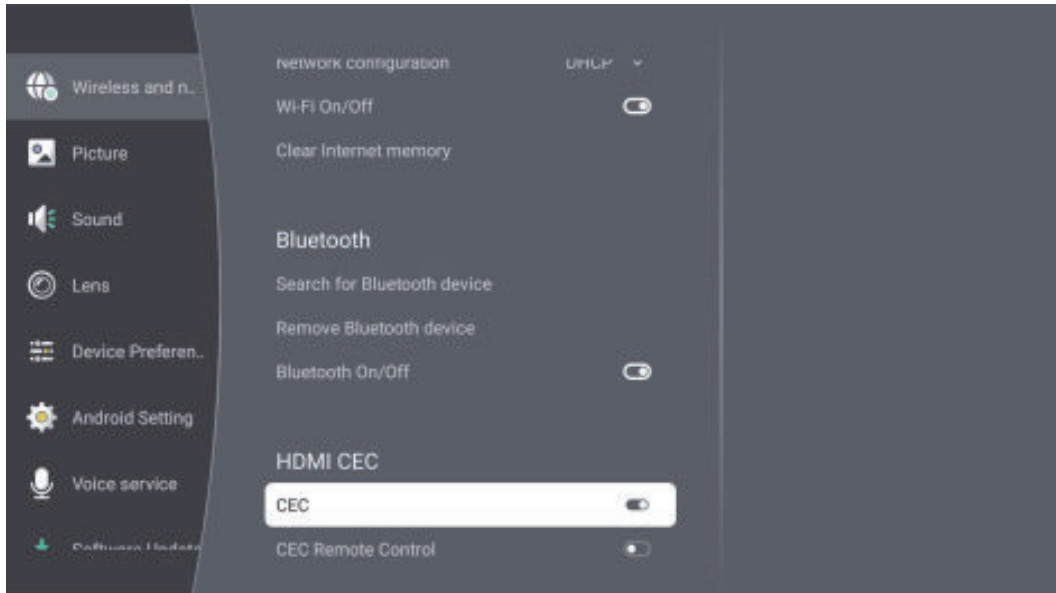

## Picture Setting

⚙️ Click Setting icon on the homepage – Setting – Picture > Perform personalized picture settings, change picture mode, set eye protection mode, set noise reduction DLC.

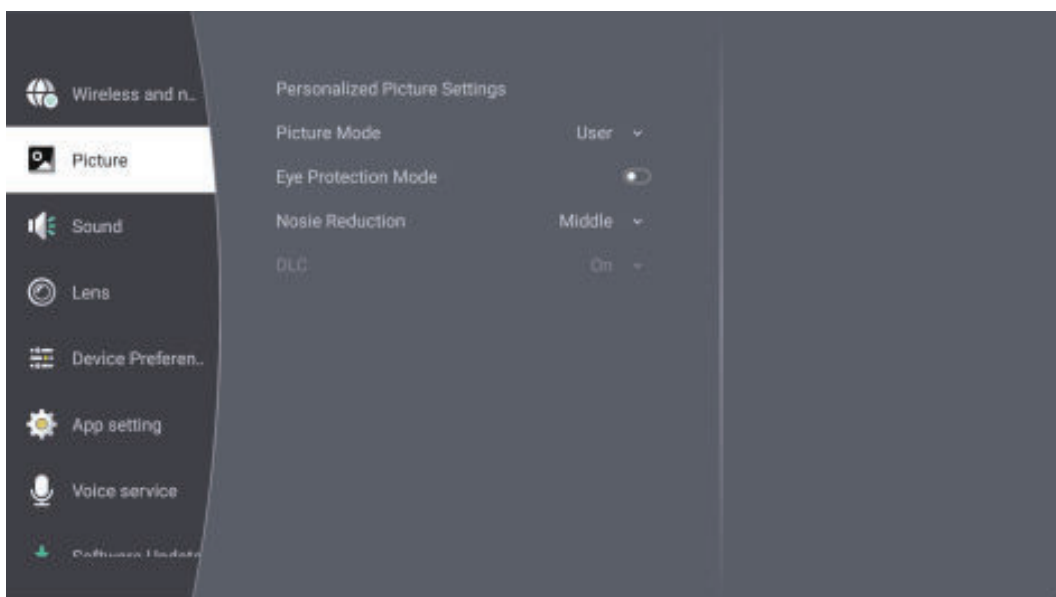

# Sound Setting

⚙️ Click Setting icon on the homepage - Setting - Sound > Set the sound quality balance of the machine sound, adjust the sound mode, set the AVC, surround effect, and choose the output device and output format of the sound.

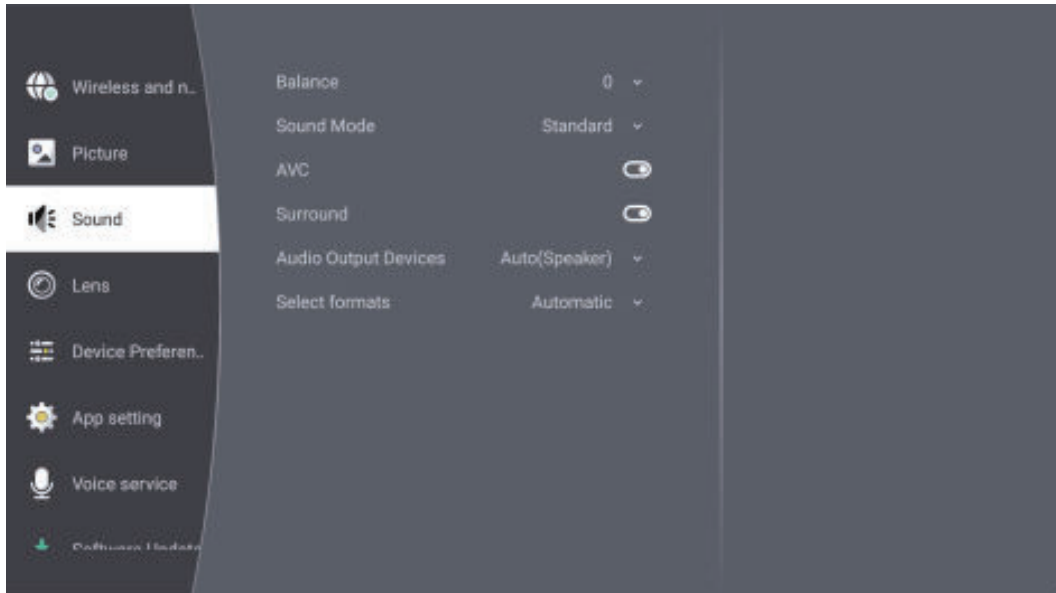

# Lens Setting

⚙️ Click Setting icon on the homepage - Setting - Lens > Set the projection direction, autofocus, keystone correction, digital zoom.

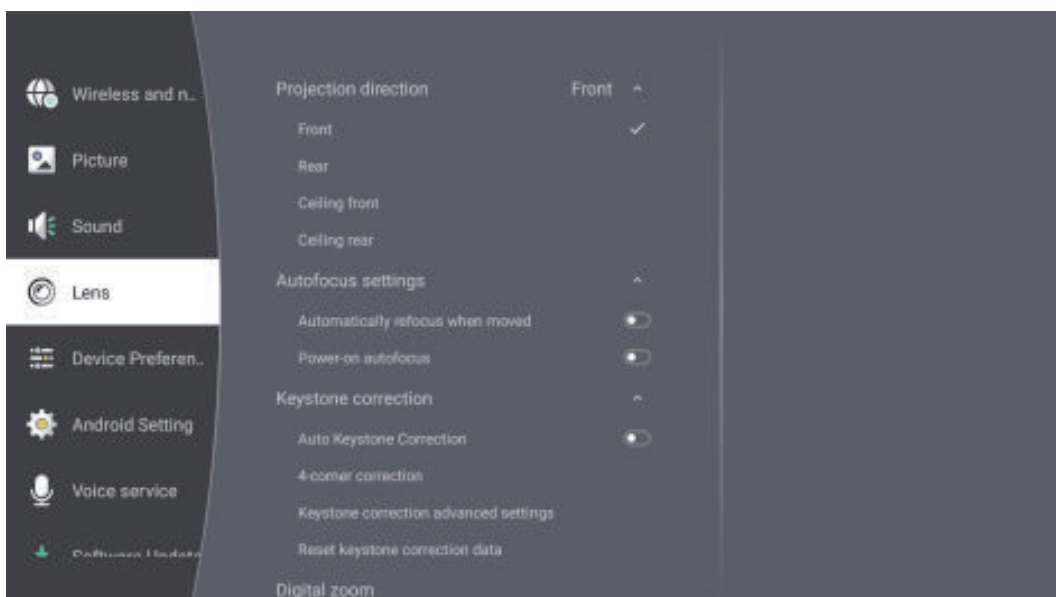

## Device Preference

⚙️ Click Setting icon on the homepage - Setting - Device Preference > Change language, set date and time, choose keyboard, set sleep timer, check device information, reset projector, restart projector, whale OS cast, set energy saver, menu timer, location, power desktop.



## Whale OS Cast

⚙️ Click Setting icon on the homepage - Setting - Device Preference - Whale OS Cast > Three mirroring ways are available <TV Casting, DLNA, Miracast>

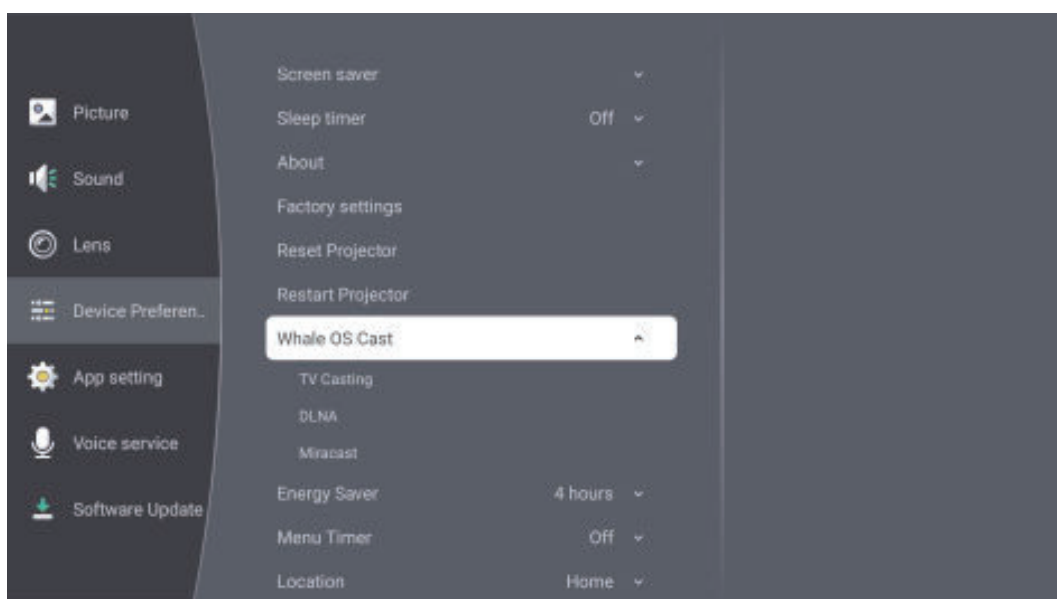

# App Setting

⚙️ Click Setting icon on the homepage - Setting - App Setting > Check recently opened applications, view all applications, and app permissions.

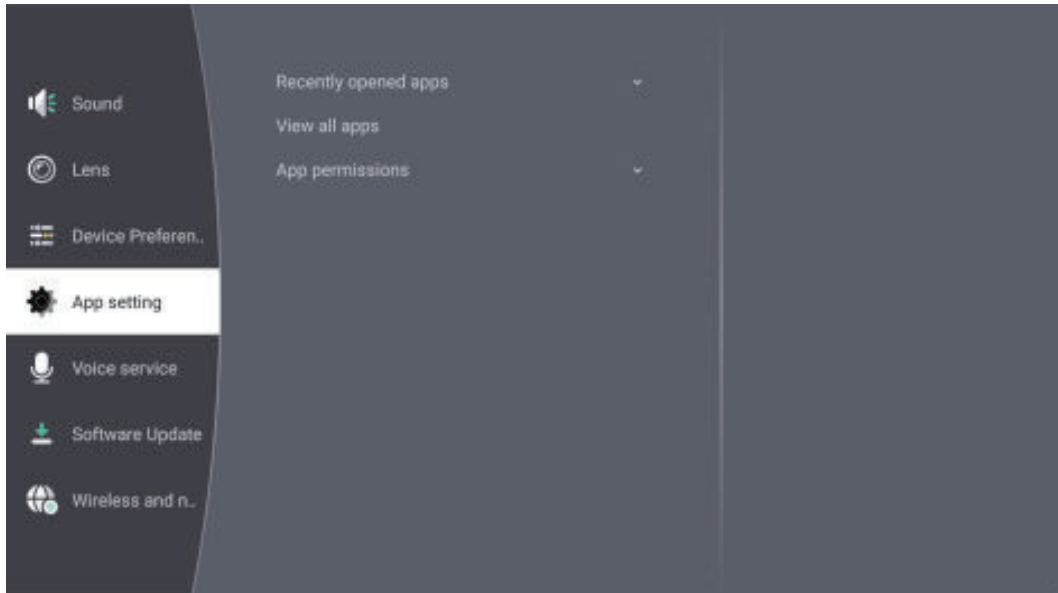

# Voice Service

⚙️ Click Setting icon on the homepage - Setting - Voice Service > The language selection and timbre of intelligent speech can be adjusted.

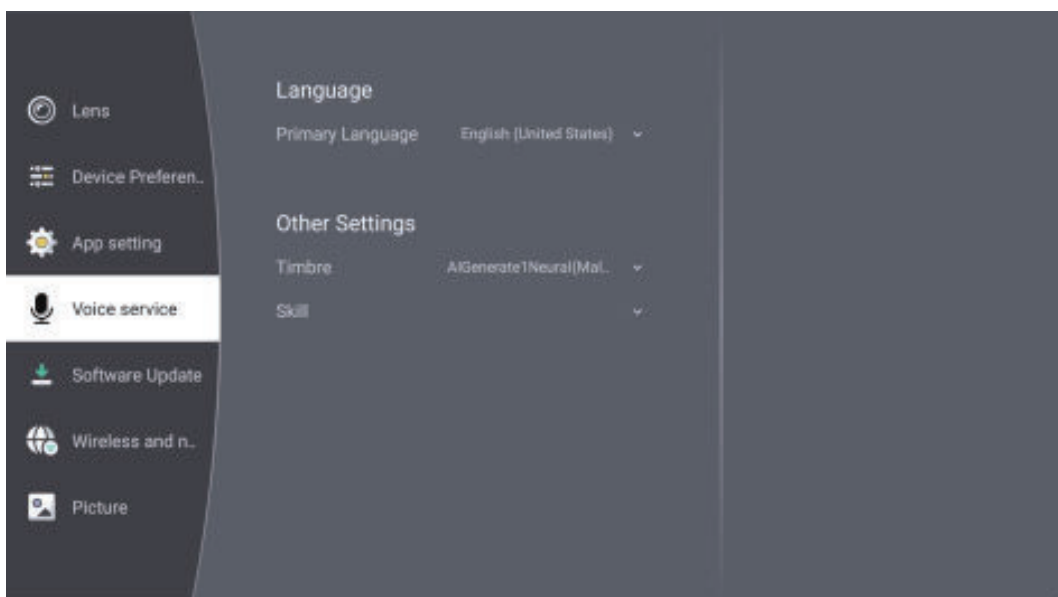

# Software Update

⚙️ Click Setting icon on the homepage - Setting - Software Update > Update the software and view the current software information.

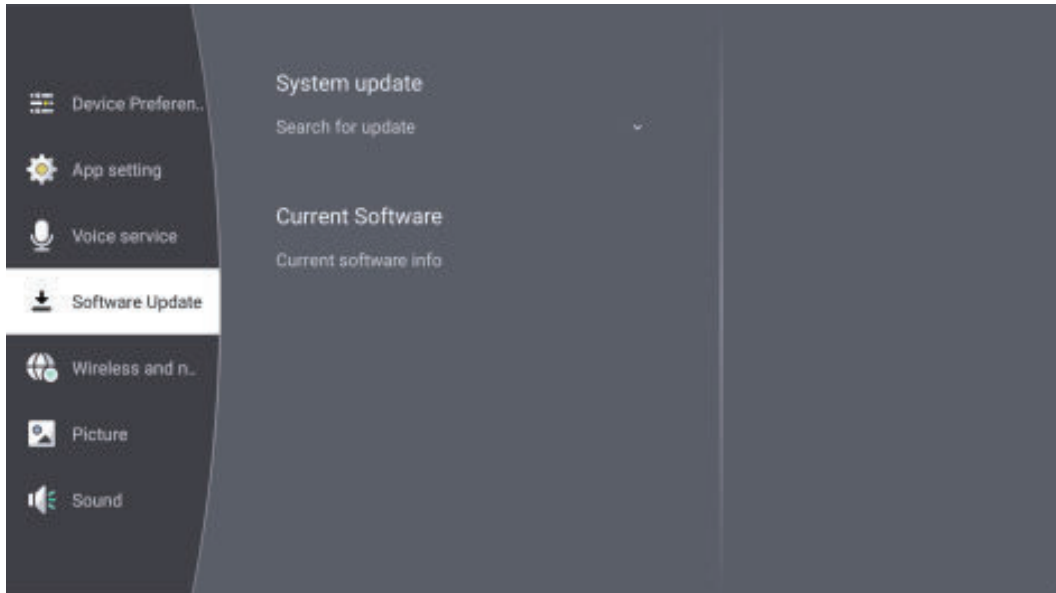

# File Management

📁 Insert the U disk, click the File icon on the homepage. The content of U disk could be read, such as video, audio, picture, etc.

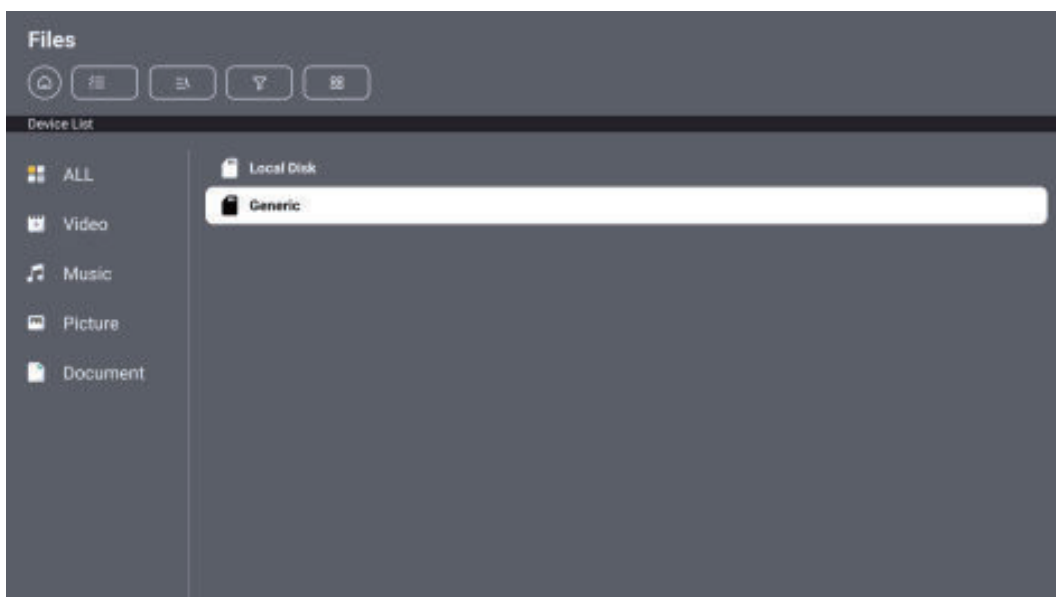

# Bluetooth Speaker

⚙️ Find the Bluetooth speaker icon on the desktop, click to enter the Bluetooth speaker mode.

Search for machine name on your mobile phone, and then pair and connect.

Click <Turning off the screen> to turn off the screen, and press the back button to exit the screen off state.

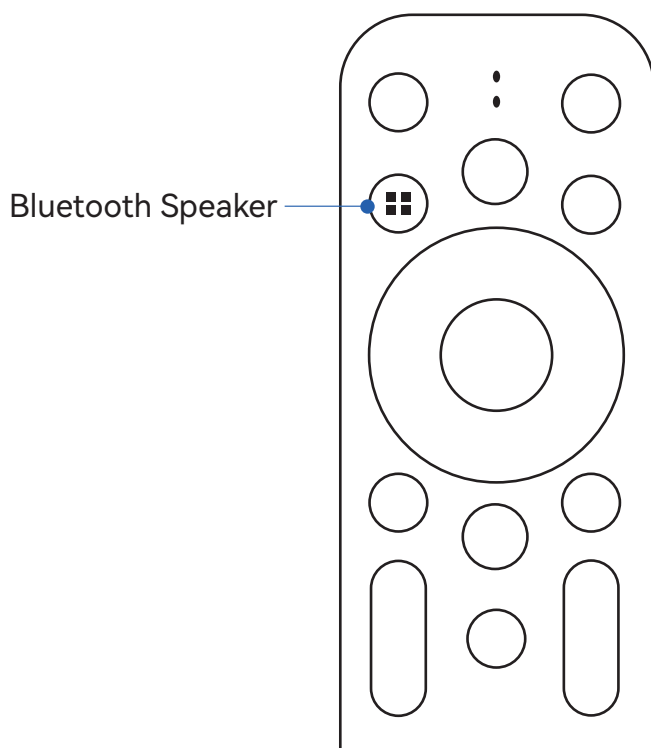
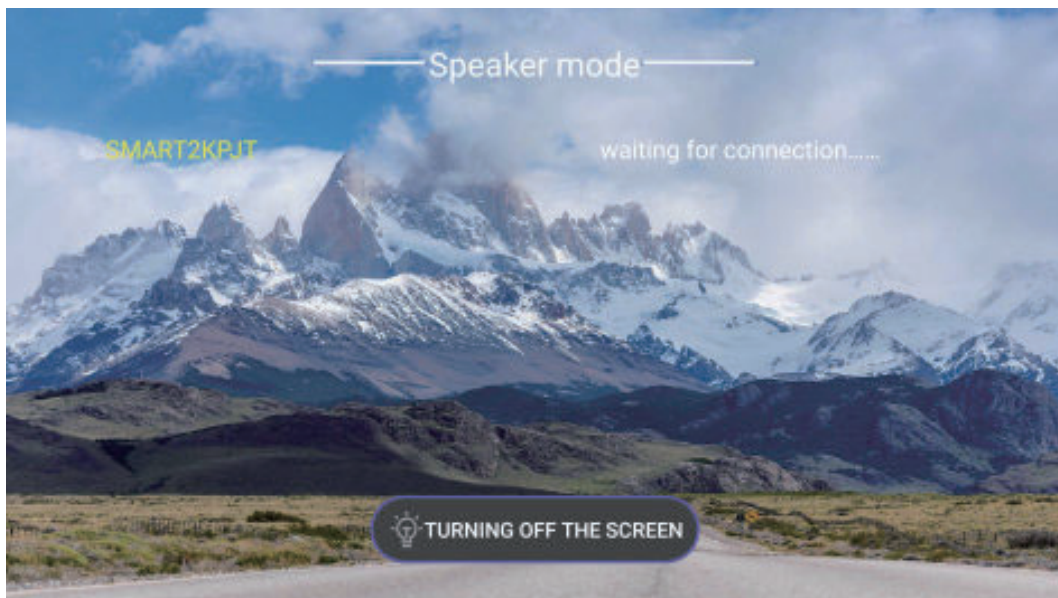

## Signal Source

⚙️ Click the signal source icon on the homepage, choose HDMI and AV input signal source.

The terms HDMI, HDMI High-Definition Multimedia Interface, HDMI Trade dress and the HDMI Logos are trademarks or registered trademarks of HDMI Licensing Administrator, Inc.

## **FCC STATEMENT:**

This device complies with Part 15 of the FCC Rules.

Operation is subject to the following two conditions:

- (1) This device may not cause harmful interference, and
- (2) This device must accept any interference received, including interference that may cause undesired operation.

Warning: Changes or modifications not expressly approved by the party responsible for compliance could void the user's authority to operate the equipment.

NOTE: This equipment has been tested and found to comply with the limits for a Class B digital device, pursuant to Part 15 of the FCC Rules. These limits are designed to provide reasonable protection against harmful interference in a residential installation. This equipment generates uses and can radiate radio frequency energy and, if not installed and used in accordance with the instructions, may cause harmful interference to radio communications. However, there is no guarantee that interference will not occur in a particular installation. If this equipment does cause harmful interference to radio or television reception, which can be determined by turning the equipment off and on, the user is encouraged to try to correct the interference by one or more of the following measures:

- Reorient or relocate the receiving antenna.

- Increase the separation between the equipment and receiver.

- Connect the equipment into an outlet on a circuit different from that to which the receiver is connected.

- Consult the dealer or an experienced radio/TV technician for help.

### **FCC Radiation Exposure Statement:**

This equipment complies with FCC radiation exposure limits set forth for an uncontrolled environment. This equipment should be installed and operated with minimum distance 20cm between the radiator & your body.



## ISED Statement

English: This device contains licence-exempt transmitter(s)/receiver(s) that comply with Innovation, Science and Economic Development Canada's licence-exempt RSS(s).

Operation is subject to the following two conditions:

- (1) This device may not cause interference.
- (2) This device must accept any interference, including interference that may cause undesired operation of the device.

The digital apparatus complies with Canadian CAN ICES-3 (B)/NMB-3(B).

French: Cet appareil contient des émetteurs/récepteurs exempts de licence qui sont conformes aux RSS exemptés de licence d'Innovation, Sciences et Développement économique Canada.

L'exploitation est soumise aux deux conditions suivantes :

- (1) Cet appareil ne doit pas provoquer d'interférences.
- (2) Cet appareil doit accepter toute interférence, y compris les interférences susceptibles de provoquer un fonctionnement indésirable de l'appareil.

l'appareil numérique du ciem conforme canadien peut - 3 (b) / nmb - 3 (b).

The device for operation in the band 5150–5250 MHz is only for indoor use.

L'appareil pour fonctionner dans la bande 5150–5250 MHz est uniquement pour une utilisation à l'intérieur.

This equipment complies with Canada radiation exposure limits set forth for an uncontrolled environment.

Cet équipement est conforme aux limites d'exposition aux rayonnements du Canada établies pour un environnement non contrôlé.

This equipment should be installed and operated with minimum distance 20cm between the radiator & your body.

Cet équipement doit être installé et utilisé à une distance minimale de 20 cm entre le radiateur et votre corps.