

警告/WARNING

1. 安装之前请仔细阅读以下说明。
2. 本产品支持直流电压9V-36V, 专用于摩托车上。
3. 安装之前请关闭摩托车电源, 安装完成后再开启电源。
4. 粘贴摄像头支架时, 请确保粘贴区域洁净, 车上打蜡会影响粘贴效果。可以用打火机或热风枪加热3M胶贴再粘贴。
5. 严禁使用高压水枪冲洗机器, 以免机身进水!
6. HM502摄像头为全密闭防水, 但仍需避免使用去渍油、酒精、柏油清洗剂等溶剂接触到镜头, 以免破坏防水层。
7. 为了文件存储的速度和安全, 请定期清理TF卡。

1. Please read these instructions carefully.
2. This product supports 9-36V power supply and is designed for use on motorcycles.
3. Please turn off the power of motorcycle before finishing installation.
4. When install the camera bracket, please ensure that area is clean. Vehicle waxing will affect the installation effect. Before installation can use lighter or hot gun to heat 3M sticker.
5. Do not use high-pressure water gun to flush the machine!
6. HM502 cameras are fully sealed waterproof, but still need to avoid using Cleaning Naphtha, alcohol, and Solvents such as tar detergent come into contact with the lens to prevent damage the waterproof layer.
7. For storage speed and security, please clean the TF card regularly.

安装指南 Installation guide

PART 1

① TF卡安装 TF card installation

使用专用十字螺丝刀打开防盗防水塞, 螺丝固定在胶塞上, 请勿取出。
Use screwdriver to open the plug. The screw is stuck in the plug, please don't take out.

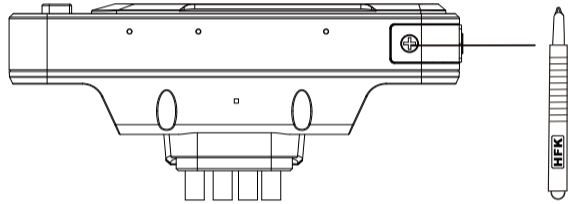

安装好TF卡后, 请盖好防盗防水塞并拧紧防盗螺丝。
After installing the TF card, please cover the plug and tighten the screw.

安装TF卡前请把卡内文件转移至其它位置存放。TF卡第一次装入后开机时主机屏幕会提示“初次使用TF卡需执行格式化, 将会删除所有数据”, 按确认键即可执行格式化操作。
Before installing TF card, please transform all data to other storage. First time to install the TF card the screen will have notice “First to use TF card it need to format, it will delete all data”, press “OK” to finish formatting.

将防盗防水塞向下推约5mm
Push down the plug 5mm

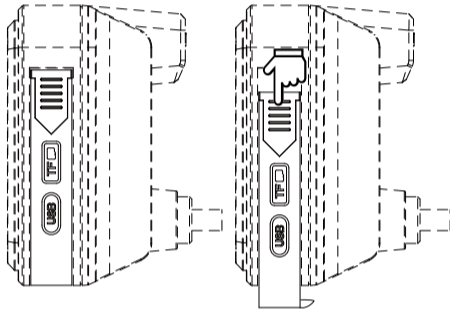

注意: TF卡金属条朝向主机屏幕, 最大支持512G TF卡
Note: TF card metal side up to the main screen side (max support for 512GB TF card)

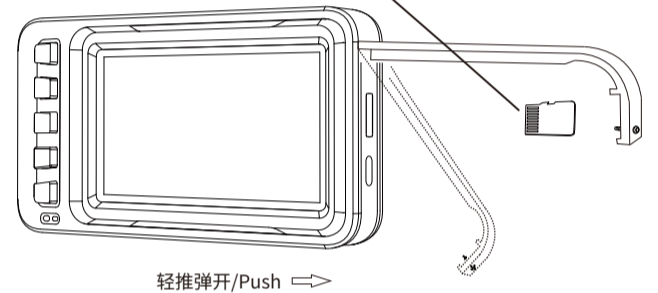

轻推弹出/Push →

提示: HM702内置有eMMC 256GB储存, 无需插入TF卡也能正常工作。未插入TF卡时, 视频文件存入eMMC且正常循环录像; 插入TF卡(最大支持512GB)后, 视频文件存入TF卡, 循环录像时只覆盖TF卡内的文件, 当视频被锁定时, 该视频会同时存入TF卡和eMMC (TF卡弹出或接触不良时视频直接录入eMMC)。

Note: HM702 built-in eMMC 512GB storage, it can running without TF card. Without inserting TF card, all video files will save in eMMC and loop recording normally. Insert TF card(max support 512GB), video files will save in TF card, loop recording will only overwrite TF card saved files. When the video locked, the video will saved in TF card and eMMC (if TF card ejected or not well contacted, the video will saved to eMMC).

② 主机支架安装 Main host bracket installation

主机支架可多方位多角度转动, 请先选好安装位置并调整好角度后, 再拧紧螺丝。
请根据车把直径选择相应垫片, 车把直径为32mm时不需要用垫片。使用25.4mm和22mm垫片时需要配合28mm垫片使用。

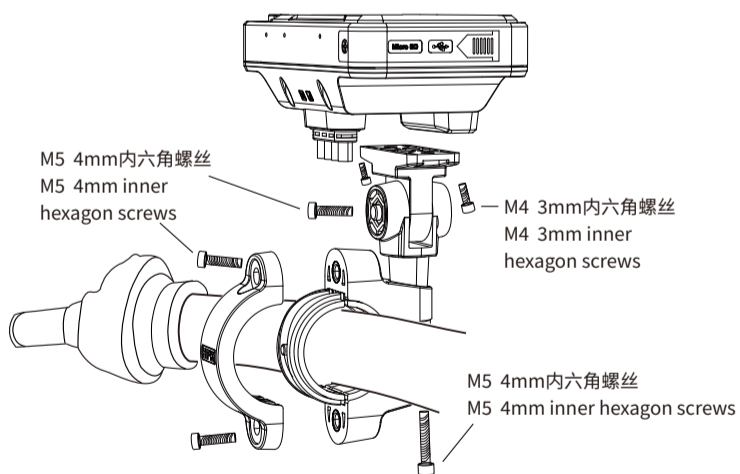

main host can be rotated in different angles. Please choose right place and adjust the angle before installation, tighten the screws.

Please choose the right spacer based on your motorcycle handlebar. There is no need to use spacer when the handlebar is 32mm. When using 25.4mm and 22mm spacer, it is necessary to cooperate with 28mm piece.

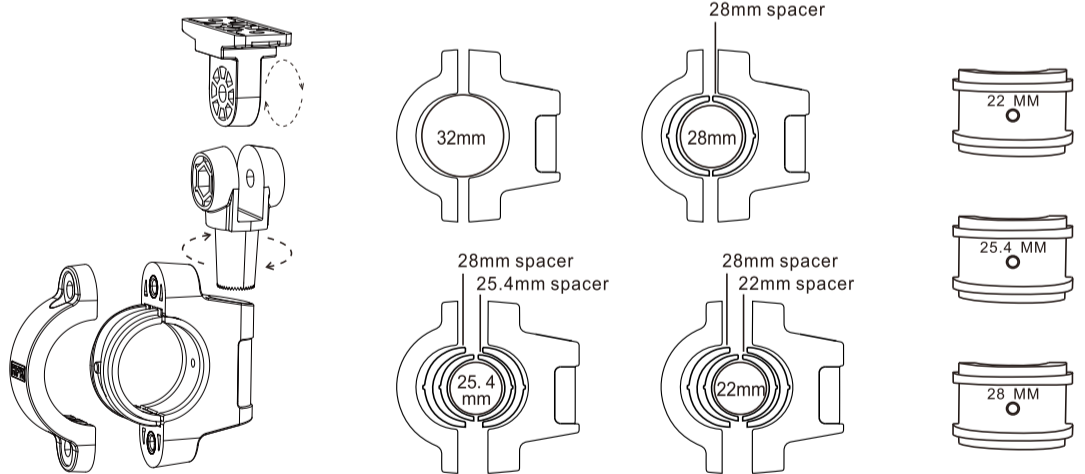

③ 前后摄像头安装 Front and rear camera installation

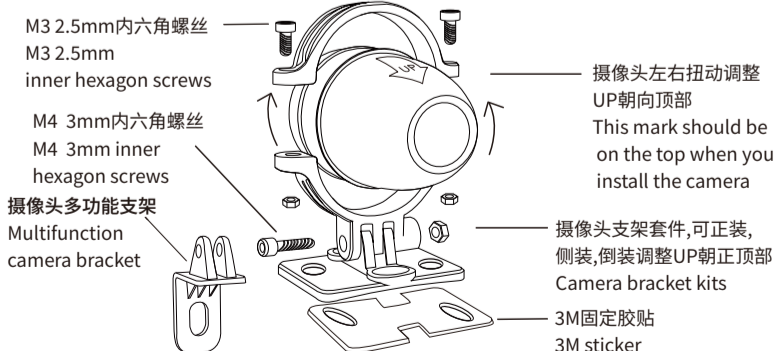

④ 不锈钢主机支架安装方式 Stainless steel main host bracket installation

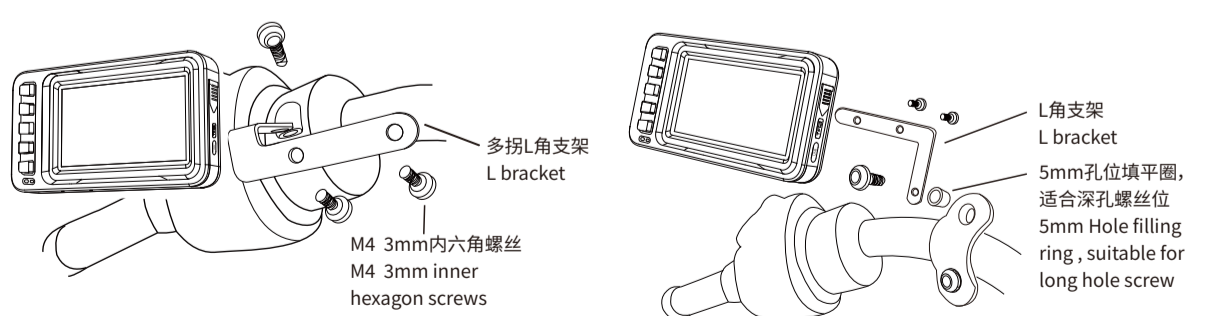

警告 WARNING

本产品支持IP67防水, 严禁使用高压水枪冲洗, 以免机身进水!
若因此导致的机器故障, 不在保修范围内!
This product waterproof IP67. Forbidden to use high-pressure water gun to flush the DVR. If damage caused by this reason, no warranty.

注意事项:

- 初次安装时还需要进行倾斜角度校正和数据清零操作,校正时请将车辆摆放在水平位置,以保障校正数据的准确性。
- 安装时请确保主机与水平面的夹角在20°以内且尽量与车头仪表平行,如果超出范围可能会导致倾斜角度数据会产生一定的偏差。

Notice:

- Tilt angle correction and data clearing are required during initial installation. Make sure motorcycle on flat ground to ensure the data accuracy.
- During installation, please ensure that the angle between the main host and the horizontal plane is within 20 degrees and keep parallel to the front instrument as far as possible. If it is beyond the range, tilt angle data may cause deviation.

标准安装图/Standard installation drawing

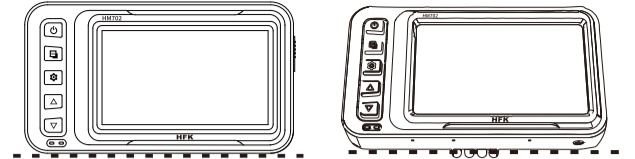

主机与水平面平行且与车头仪表平行
The main host is parallel to the horizontal plane and keep parallel to the front instrument.

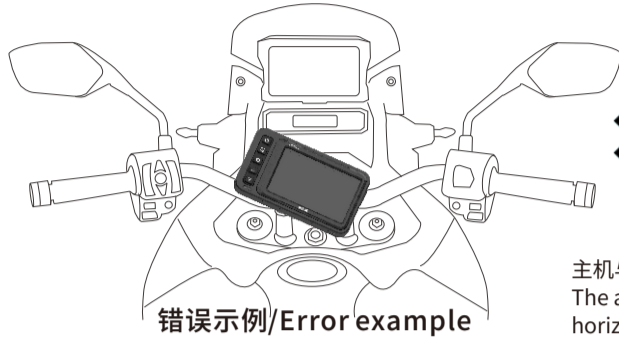
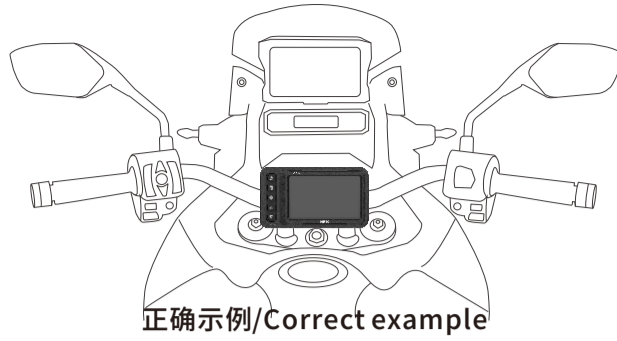

主机与水平面的夹角超过20°
The angle between the main host and the horizontal plane is over 20 degrees.



主机侧面露出,主机与车头仪表不平行且夹角太大
Horizontal plane sees the side of main host, the main host and the front instrument are not parallel and the angle is too large.

**安装组合图
The installation drawings**

PART 2

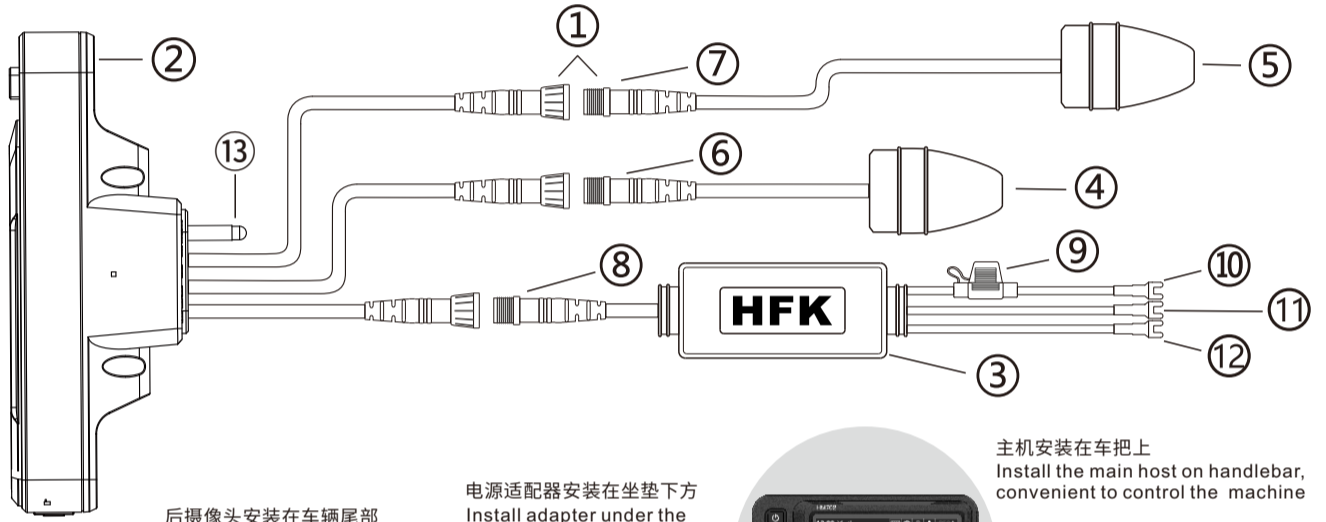
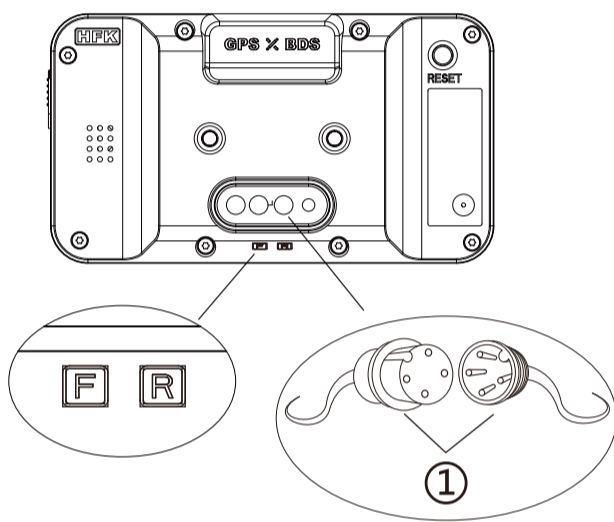

- | | |
|------------------|---|
| ①注:连接线路时对准卡槽和颜色 | ① Note: please connect the cable correctly with right color |
| ②HM702主机 | ② HM702 Main Host |
| ③电源适配器 | ③ Power adapter |
| ④前摄像头 | ④ Front camera |
| ⑤后摄像头 | ⑤ Rear camera |
| ⑥连接前摄像头(短线,前摄像头) | ⑥ Connect with front camera (The short wire) |
| ⑦连接后摄像头(长线,后摄像头) | ⑦ Connect with rear camera (The long wire) |
| ⑧连接电源适配器(红色) | ⑧ The red cord connect with power adapter |
| ⑨保险丝 | ⑨ Fuse |
| ⑩红色B+(电源正极) | ⑩ Red B+ (positive) |
| ⑪橙色接ACC电源 | ⑪ Orange ACC Power |
| ⑫黑色地线(电源负极) | ⑫ The black cord lead to ground (negative) |
| ⑬环境温度探头 | ⑬ Temperature sensor |

提示:ACC信号线接摩托车ACC电源上,可随摩托车开关钥匙自动开关机。也可接在摩托车电源正极上,则需要手动开关机,摩托车熄火后请记得关机,以免消耗摩托车电瓶电量。(建议接摩托车ACC电源上)
Note: ACC signal line connected with motorcycle ACC power, can be switched on/off with motorcycle key. It also can be connected to the positive of the motorcycle power supply, so that you need to turn on by manually. Please remember to shut down the DVR after the motorcycle is turned off to avoid power consumption of motorcycle. (Recommended to connect the motorcycle ACC power supply)



**HM702操作
HM702 operation**

PART 3

**按键介绍及操作
Function Buttons and operation**

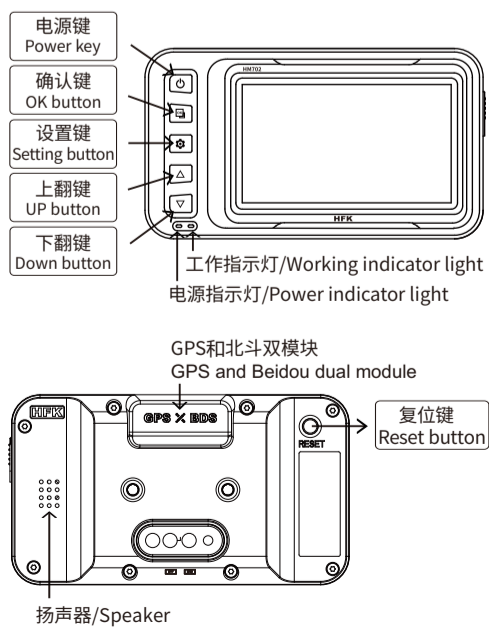

电源键: 短按开机, 长按三秒以上关机。开机状态下, 短按调节屏幕亮度和倾斜角度指示灯亮度, 亮度分四档: 100%亮度、60%亮度、30%亮度和熄屏(指示灯熄灭), 依次循环。默认屏幕亮度为100%, 系统会保存已调节好的屏幕亮度。如果息屏状态下关机, 那么再次开机时屏幕的亮度为100%亮度。若连接机车ACC电源则拧开钥匙自动开机并开始录像, 关闭钥匙则自动关机。

确认键: 录像界面下短按为停止录像。停止录像后长按进入拍照界面(短按即可拍照, 前后摄像头各拍一张), 再次长按进入播放模式, 可查看拍摄的视频和图片(按上翻、下翻键选择要查看的文件---短按播放---再次短按暂停播放/长按结束播放), 第三次长按返回录像界面。在设置功能选项中为确认键。时速界面下长按3秒清除最高时速记录、小计里程和单次行车时长; 指南针界面长按3秒清除最大海拔和GPS高度; 直线竞速界面下短按为确认选择, 长按3秒清除直线竞速成绩记录; 在倾斜角度界面下长按3秒进入倾斜角度数据清零或倾斜角度校正操作; 我的旅程界面长按3秒清除所有界面内的所有数据记录。

设置键: 录像状态下短按为锁定视频, 长按为开/关WIFI。停止录像后短按进入视频设置界面(按上翻、下翻键选择需要设置的项目---按确认键进入---按上翻、下翻键选择所需内容---按确认键确定选择), 再次短按进入系统设置界面, 第三次短按退出设置。

上翻键: 录像时短按为切换时速界面, 录像显示界面, 胎压显示界面, 我的旅程界面, 倾斜角度界面, 直线竞速界面, 指南针界面, 长按1秒为循环切换前、后摄像头和大小窗显示。设置界面下为向上选择功能。直线竞速界面下长按1秒为向上选择竞速菜单。

下翻键: 录像时短按为切换时速界面, 指南针界面, 直线竞速界面, 倾斜角度界面, 我的旅程界面, 胎压显示界面, 录像显示界面, 长按1秒为循环切换前、后摄像头和大小窗显示。设置界面下为向下选择功能。直线竞速界面下长按1秒为向下选择竞速菜单。

工作指示灯: 录像时一秒一闪, 停止录像后熄灭。

电源指示灯: 开机后灯亮, 内置电池充满后灯灭。

注: 1. 关闭直线竞速或倾斜角度功能后, 主机上不再显示相应界面;
2. 胎压显示界面可以在胎压设置菜单打开, 或者与胎压监测器匹配成功后打开。

Power key: Short press to power on the machine, keep pressing over 3 seconds to power off. In boot process, short press to adjust the screen brightness and tilt angle indicator brightness. The indicator brightness is divided in 4 levels: 100% brightness, 60% brightness, 30% brightness and off the screen (indicator off). The default screen brightness is 100%. The system will save the adjusted brightness. If you turn off the machine in the screen off state, then the brightness is 100% when you turn on the machine again. If connected with motorcycle ACC power, unscrew the motorcycle key the DVR will automatically start on and recording, off the key the DVR will automatically shut down.

"OK" button: Short press in the recording status to pause the recording. After pausing the video, long press to enter in camera interface (short press to take photos--each camera will take one). Long press again will enter in play mode, you can view the videos and pictures (press UP/Down button to select the review file--- short press to play --- short press again to pause / long press to end play). The third long press to return to the video interface. In speed interface long press 3seconds to clear the highest speed and the max tilt angle data. In compass interface long press 3 seconds to clear the highest altitude and GPS altitude data. In straight racing interface short press to confirm the selection, long press 3seconds to clear the racing records. In tilt angle interface long press 3 seconds to clear the tilt angle data or correct tilt angle. In my route interface long press 3seconds to clear all data records in all interfaces.

Setting button: Short press to lock video in recording status, long press to on/off WIFI. After pausing the recording, short press to enter the video settings interface (press UP/Down button to select the items that need to set--- press "OK" to enter--- press UP/Down to the selection--- press "OK" to confirm). Short press again to enter the system settings interface. The third short press to exit settings.

UP button: When in recording status, short press to switch the speed interface, recording interface, tire pressure display interface, my route interface, tilt angle interface, straight racing and the compass interface. Long press 1 second for switching front / rear camera to be displayed separately or the front/rear camera size window displayed. In settings interface, this button is up selection function. "Straight racing" interface long press 1 second to up select racing mode.

Down button: When in recording status, short press to switch the speed interface, compass interface, straight racing, tilt angle interface, my route interface, tire pressure display interface and recording interface. Long press 1 second for switching front / rear camera to be displayed separately or the front/rear camera size window displayed. In settings interface, this button is down selection function. "Straight racing" interface long press 1 second to down select racing mode.

Working Indicator: When recording it flashes every second, pause recording it always on.

Power Indicator: Power on it lights on, the built-in battery fully charged it lights off.

Note: 1, Turn off the function of "Straight racing" or "Tilt angle", the interface will no longer display on the main host screen. 2, The tire pressure display interface can be opened in the tire pressure setting menu or after successfully matching with the tire pressure monitor.

主机屏幕界面介绍/Introduction of main host screen interfaces

录像显示界面/ Recording interface

时速界面/ Speed interface

直线竞速界面/ Straight racing interface

倾斜角度界面/ Tilt angle interface

指南针界面/ Compass interface

我的旅程界面/ My route interface

录像显示界面/ Tire pressure display interface

① 录像状态(红点闪烁代表正在录像)/Recording (red light flashing shows DVR is recording now)
 ② 循环录像时间/Time cycle of recording
 ③ 前摄像头分辨率/Front camera resolution
 ④ 后摄像头分辨率/Rear camera resolution
 ⑤ 环境温度/Ambient temperature
 ⑥ GPS信号状态/GPS signal
 ⑦ 录像声音开关状态/Recording voice On/Off
 ⑧ TF卡状态/TF card status
 ⑨ 供电/Battery
 ⑩ 录像时间/Recording time length
 ⑪ 当前时速/Current Speed
 ⑫ 海拔/Altitude

⑬ GPS高度/GPS Altitude
 ⑭ 气压/ Air Pressure
 ⑮ 指南针/ Compass
 ⑯ 拍照/Photo
 ⑰ 视频锁定/Video lock
 ⑱ 胎压数值/Tire pressure value
 ⑲ 小计里程/Subtotal mileage
 ⑳ 单次行驶时长/Single driving time
 ㉑ 5次成绩记录/5 records
 ㉒ 最佳成绩/Best record
 ㉓ 3分钟录像倒计时
 3-minute video countdown
 ㉔ 当前竞速时间/Current racing time

㉕ 直线竞速0-100km/h Straight racing 0-100km/h
 ㉖ 直线竞速0-400m/Straight racing 0-400m
 ㉗ 当前时速/Current Speed
 ㉘ 当前竞速距离/Current racing distance
 ㉙ 左侧最大倾角时的时速/
 Speed at max. tilt angle on the left
 ㉚ 左侧最大倾角记录/Max.tilt angle record on the left
 ㉛ 右侧最大倾角时的时速/
 Speed at max. tilt angle on the right
 ㉜ 右侧最大倾角记录/Max.tilt angle record on the right
 ㉝ 实时倾斜角度显示/Current tilt angle
 ㉞ 指南针/ Compass
 ㉟ 最高海拔记录/Highest altitude

- ③⑥ 经纬度/Longitude and latitude
- ③⑦ 前轮胎压报警/Front tire pressure alarm (正常蓝色, 报警变红/Normal blue, alarm turns red)
- ③⑧ 前轮胎压数值/Front tire pressure value
- ③⑨ 前轮胎温/Front tire temperature
- ④⑩ 后轮胎压报警/Rear tire pressure alarm (正常蓝色, 报警变红/Normal blue, alarm turns red)
- ④⑪ 后轮胎压数值/Rear tire pressure value
- ④⑫ 后轮胎温/Rear tire temperature

我的旅程: 记录骑行过程中的总里程、总行驶时间、平均行驶速度、最高海拔、最大倾角、最大速度。在我的旅程界面长按3秒清除所有界面内的所有数据记录, 然后重新开始记录。(其它界面数据记录清零时不影响我的旅程界面的任何数据)

My route: Record the total mileage, total driving time, average driving speed, highest altitude, max.tilt angle, fastest driving speed. In my route interface long press 3seconds to clear all data records in all interfaces, and restart to record. (clear other interfaces data records will not affect any data of my route interface)

注:1, 图中“拍照”图标只有在按下遥控器“拍照键”时才会显示, 拍照结束后不再显示。“视频锁定”图标只有在当前视频被锁定时才会显示。

2, 未配对胎压发射器时, 时速界面⑱为最高时速数据。

Note:1, The “Photo” icon in the pictures will only be displayed when the remote control “Photo” button is pressed, and it will not be displayed after taking photos. “Video Lock” icon will only be displayed when the current video is locked.

Note:2, When the tire pressure transmitter is not paired, the speed interface ⑱ is the maximum speed data.

HM702设置界面/ HM702 Setting

Video X

- 分辨率 Resolution
- 循环录像 Loop Recording
- 视频合成 Video Synthesis
- GPS
- 卫星 Satellite
- 停车守卫 Parking Guard
- 重力感应 G-sensor
- 录音音频 Audio

Video X

- 日期标签 Date Stamp
- 指南针 Compass
- 气压 Air Pressure
- 海拔 Altitude
- GPS高度 GPS Altitude
- GPS LAL
- 速度 Speed
- 疲劳驾驶 Fatigue Driving

Video X

- 直线竞速 Straight Racing
- 延时关机 Delayed Shutdown
- 倾斜角度 Tilt Angle
- 公/英单位转换 Conversion

Setup X

- WIFI
- 日期/时间 Date/Time
- 遥控配对 Auto Matching
- 胎压 Tire Pressure
- 温度 Temperature
- 屏幕保护 Screen Off Delay
- 按键声音 Beep Sound
- 图像旋转 Image Rotation
- 时区 Time Zone
- 语言设置 Language
- 格式化 Format
- 恢复出厂设置 Default Set
- 版本 Version

视频设置菜单

分辨率: 选择录制视频的分辨率, 默认为2560*1440P30_2560*1440P30且前后摄像头所录制的视频分辨率保持一致。

循环录像: 设置录像的分段时长, 分为1分钟、3分钟和5分钟。默认为3分钟(每段视频时长为3分钟), 录满(eMMC和TF卡)后会自动覆盖最早的文件。

视频合成: 开启该功能后, 前后摄像头拍摄的画面将合二为一, 只生成一个视频文件。合成的视频以大小窗的形式展示前后摄像头所拍摄的画面。默认为关闭, 关闭后, 前后摄像头拍摄的视频会分成两个单独文件。

GPS: 设置GPS的开启或关闭, 开启后可侦测摩托车速度、GPS高度、当前行驶位置的经纬度以及指南针功能, 关闭后记录仪将无法提供这些数据和功能。

卫星: 显示时间、速度、经纬度、卫星颗数和星值。颗星越多、星值越大代表信号越强, 若GPS无信号或关闭将无法接收卫星信号。

停车守卫: 开启后, 摩托车钥匙后受到碰撞时会自动录像10秒, 该功能需接ACC才能使用。每次开机后, 停车守卫功能关闭, 需要停车前再次开启才能继续生效。

重力感应: 设置视频碰撞锁定功能的碰撞识别灵敏度, 分为越野路面、综合路面(推荐)、城市路面和关闭四种, 请根据实际路况选择相应选项, 默认为综合路面(推荐)。

录音音频: 设置记录仪录像时是否同时录音, 分开启和关闭两个状态, 关闭后录制的视频没有声音。

日期标签: 打开后视频中显示HFK logo和日期, 关闭后视频中将不再显示, 默认为打开。

指南针: 开启后主机屏幕上会显示指南针, 在APP中可以通过添加水印的方式合成到视频上。关闭后, 主机上不再显示, APP中仍然可以添加指南针水印, 默认为开启, 若GPS无信号或关闭将无法提供数据。

气压: 开启后主机屏幕上会显示所在区域实时气压信息, 视频上也会生成气压数据标签。关闭后, 主机和视频上都不显示。默认为开启。

海拔: 开启后主机屏幕上会显示所在区域实时海拔信息, 视频上也会生成海拔数据标签。关闭后, 主机和视频上都不显示。默认为开启。

GPS高度: 开启后主机屏幕上会显示所在区域的实时GPS高度信息, 须开启GPS才能使用。关闭后, 主机上不再显示GPS高度信息, 默认为开启。若GPS无信号或关闭将无法提供数据。

GPS经纬度: 开启后主机屏幕上显示摩托车当前位置经纬度, 须开启GPS才能使用。关闭后, 主机上不再显示GPS经纬度信息, 但在APP中可以通过添加水印的方式调取, 默认为开启。若GPS无信号或关闭将无法提供数据。

速度: 开启后主机屏幕上显示摩托车当前车速, 须开启GPS才能使用, 默认为关。关闭后主机上不再显示车速, 但在APP中可以通过添加水印的方式调取, 若GPS无信号或关闭将无法提供数据。

疲劳驾驶: 开启后, 持续开机2小时后, 主机屏幕会显示疲劳驾驶提示框并伴有滴滴声(持续15秒), 之后每小时提醒一次, 关闭后将不在有提醒功能。

延时关机: 摩托车钥匙后, 记录仪延迟5秒关机, 此功能需接ACC才能使用, 默认为关。

公/英单位转换: 切换km/h和mph两种速度计量方式。

Video settings

Resolution: select the resolution of the video, the default resolution is 2560*1440 P30_2560*1440 P30, front and rear cameras keep the same video resolution.

Loop Recording: Set the duration of recording, there are 4 options: 1 minute, 3 minutes and 5 minutes . The default is 3 minutes (each video record 3 minutes). It will keep recording till the eMMC/TF card is full, the new video will overwrite before saved videos.

Video Synthesis: When turn on this function, the video can show both images of the front and rear cameras by picture in picture. The default is off. When turn off this function, the video recording by the front and rear cameras are two different videos.

GPS: Set the GPS on or off. After turning GPS on, it can show the speed , the altitude, the latitude and longitude of the motorcycle, also have the compass function. After GPS turn off, it will be not able to provide these data.

Satellite: It show the time and date, speed, latitude and longitude, number of satellites, signal value. The larger the signal value, the stronger the signal. If the GPS has no signal or turned off, it will not be able to receive satellite signals.

Parking Guard: 10 seconds of automatic video recording when the motorcycle is hit and the motorcycle key is on “Off” , this function requires ACC to be connected. After this function triggered once, you need to re-set to continue using it.

G-Sensor: Adjust the sensing of the video collision locking function, select the appropriate option according to the road conditions.

Audio: This function is designed for voice recording at the same time when DVR recording, two status: on/off. Off the setting, there is no sound in the video.

Date Stamp: The HFK logo and date will be shown in the video when turn on the DVR. It will be no longer shown in the video when it is turned off. The default is on.

Compass: The default setting is on. When it is turned on, there will have icon in the main screen. In APP, it can be synthesized into the video by adding a watermark. After being turned off, the main screen will not displayed, and the compass watermark can also be added in the APP.

Air pressure: When turned on this function, real-time pressure information will be displayed on the main screen, and pressure data mark will also be generated on the video. After shutdown, the main screen and the video will not displayed. The default setting is on.

Altitude: After turning on the main unit, the real-time altitude information of the area will be displayed on the screen of the host, and the altitude data label will also be generated on the video. After shutting down, neither the host nor the video will be displayed. The default is on.

GPS Altitude: Turn on GPS, the real-time GPS altitude information of the area will show on the screen, When turn off GPS, it will not be shown the GPS altitude information of the area on the screen. The default setting GPS is on. If the GPS has no signal or turned off, the screen will have no GPS altitude data normally.

GPS LAL: After turning on, the current position of the motorcycle will be showed on main screen. The GPS must be turned on to use it. After closing, the GPS latitude and longitude information will not be displayed on the host, but it can be retrieved by adding a watermark in the APP. The default is on. If the GPS has no signal or is turned off, it will not be able to provide data normally.

Speed: After turning on this function, the screen will show the current speed of the motorcycle. Please turn on GPS first to use this function.

Fatigue Driving: After being turned on, after 2 hours of continuous power on, the host screen will display a fatigue driving prompt box with a beeping sound (for 15 seconds), and then remind once every hour. After turning off, there will be no reminder function.

Delayed shutdown: After the motorcycle key is on “Off” , the DVR will delay 5 seconds to shutdown, this function needs to be connected with ACC.

Conversion: Miles per hour and kilometers per hour can be choosed.

系统设置菜单

WiFi: 可开启记录仪自带的5G WiFi,用手机连接后,可通过HFK APP来操作记录仪、下载文件、剪辑视频等(手机连接APP后主机不能显示实时画面)。录像状态下,长按设置键也可打开和关闭WiFi。

日期/时间: 手动调整日期和时间,选择日期显示格式。

遥控配对: 初次使用遥控器或更换遥控器时使用,确保遥控器和主机一一对应。

温度: 设置温度单位“°C”和“°F”;温度显示,开启后主机屏幕上会显示所在区域实时环境温度,视频上也会生成温度数据标签。关闭后,主机和视频上都不显示,默认为开启;低温提示,开启后,当环境温度低于3°C,主机屏幕会显示小心路面湿滑提示框并伴有滴滴声(持续15秒),关闭后将不再有提醒功能。

屏幕保护: 选择亮屏的时间,分为关闭、2分钟、3分钟、5分钟,关闭后屏幕亮,默认为关。

按键声音: 开启和关闭按键的声音,默认为打开。

图像旋转: 当主机屏幕中图像与实物左右相反时,使用该功能纠正。

时区: 设置用户所在地区的时区,默认为GMT+08:00。

语言设置: 设置记录仪的显示语言,分为简体中文、繁体中文和英文三种,默认为简体中文。

格式化: 可选择格式化eMMC和TF卡,重要文件请在格式化前妥善保存。

恢复出厂设置: 所有功能恢复到出厂时状态

版本: 显示机型和软件版本更改时间。

System setting menu

WiFi: Turn on DVR's 5G WiFi, connected with your phone, you can operate the DVR, download files, video clip etc. Connected with APP the main screen can't show current images. In recording status, long press setting button can turn on/off WiFi.

Date/Time: Manually adjust the time & date, select the format of time & date.

Auto Matching: When you use the remote controller pairing, please make sure the remote controller corresponds to the machine.

Temperature: Set the temperature units to "°C" and "°F"; Temperature display, after turning on, the host screen will display the real-time ambient temperature of the area, and temperature data labels will also be generated in the video. After shutdown, it will not be displayed on the host and video, and will default to enabled; Low temperature reminder: When the ambient temperature is below 3 °C, the host screen will display a warning box for being careful of slippery roads and accompanied by a beep sound (lasting for 15 seconds). After turning it off, there will be no reminder function.

Screen Off Delay: Choose the time of screen on: off, 2 minutes, 3 minutes, and 5 minutes. Off the setting, the screen will stay on, the default is off.

Button sound: Turn on/ off the button sound, the default is on.

Image Rotation: When the image on the main screen is opposite to the real object, use this function to correct it.

Time Zone: Set the time zone of the user's area, the default is GMT+08:00.

Language: Set the language by simplified Chinese, traditional Chinese and English. The default is simplified Chinese.

Format: You can choose to format the eMMC and TF cards. Please save important files before formatting.

Default Set: All functions are reset to the factory state.

Version: It show the model number and software version.

直线竞速 Straight racing

PART 4

直线竞速功能分为三种状态:竞速视频模式、竞速模式和关闭状态。

竞速视频模式: 默认为竞速视频模式(竞速数据写入视频,可在APP上调出并合成视频)。分为0-100km/h和0-400m两种竞速项目(仅在三分种循环录像模式且GPS开启条件下),分别记录从0-100km/h时速提速时间和400m距离骑行时间。在竞速界面选择好竞速项目后按确认键后开始(GPS信号良好),倒计时3秒后主机屏幕上会显示“Ready”,车手做好准备即可发车。从发车瞬间(车速为零)开始计时,根据选择的竞速项目,时速提升到100km/h或行驶到400m结束计时,该过程使用的时间为本次成绩。车速归零后主机屏幕上会显示“Ready”,再次发车即可进入下一次竞速,若竞速过程中停车,则在下次发车时重新计时。计时结束后,主机屏幕上会显示本次竞速成绩,若比上一次用时长则会显示红色,比上一次用时短则会显示绿色。退出竞速界面即为退出直线竞速模式。

注:1.在直线竞速界面下,长按上翻键或下翻键可切换0-100km/h和0-400m两种竞速项目,长按确认键3秒可清除主机上竞速数据。

2.在竞速视频模式下,按确认键后正在录制的视频在此刻截断并保存,然后重新开始录制竞速视频,本段视频3分钟录制完成后,须再次按确认键重新开始。若没满3分钟切换另一种竞速项目(如0-100km/h切换到0-400m),按确认键后也会截断视频并保存,然后重新开始录制。

3.主机屏幕上最多可保留5次竞速记录,5次后须手动清除。只清除主机屏幕显示,已录制视频的竞速数据可在APP中调出。

竞速模式: 竞速数据不写入视频,在APP上也不能调取相关数据。操作方式与竞速视频模式相同,但不会截断视频。该模式与视频录制互不干涉。

关闭状态: 选择关闭后,关闭直线竞速功能,主机上不再显示直线竞速界面,只显示录像界面和数据界面。

故障处理

1.竞速界面不显示或竞速视频不能添加水印:请到主机设置界面查看直线竞速功能的状态,“关闭”则不会显示竞速界面,“竞速模式”则竞速数据不写入视频,在APP上也不能添加竞速数据水印。

2.直线竞速功能无法运行:1,首先请确保GPS打开,且信号良好。2,请到主机设置界面查看直线竞速功能的状态,若是“竞速视频模式”请将录像循环时间调为3分钟。

3.竞速中速度突然为零:可能是当地GPS信号不稳定或受到干扰,请到露天开阔、GPS信号良好的地方再试。

Straight racing functions has three modes: Racing video mode, Racing mode and OFF state.

Racing video mode: The default mode is racing video mode (racing data is written into video which can be brought up and composited in APP).It is divided into two modes: 0-100 km/h and 0-400m to record the speed-up time from 0-100km/h and the riding time of 400m distance(Only on the state of GPS is ON and 3 minutes loop recording mode). After selecting the mode in straight racing interface, press “OK” to start (GPS signal should be good),countdown 3 seconds, “Ready” will be showed in main host screen. racer is ready to start.

The timing starts at the departure moment (vehicle speed is zero), according to the selected mode, when the speed is increased to 100km/h or raced to 400m, the timing ends. This process timing is one record. Vehicle speed is 0 km/h the main host screen will show “Ready”,you will enter the second round of racing. If you stop during the racing, the timing will restart at the next racing. One round finished the latest records will be displayed in the main host screen .Taking longer time record in red, shorter in green. Exiting the straight racing interface means exiting the racing mode.

Note:1.In straight racing mode interface, long press UP/Down button to switch 0-100km/h and 0-400m.Long press for 3 seconds can clear all racing date in main host screen.

2.In racing vide mode, press “OK” the recording video will be cut and saved, then keep recording racing video. It is need to press “OK” again to restart after 3 minutes video finished recording. If you don't get 3 minutes to switch to another racing mode (e.g. 0-100km/h to 0-400m), the video will also be cut and saved after pressing the confirm button, then the recording will start again.

3,Up to 5 race records can be kept in main host screen, and they will be cleared manually after 5 races. Only clear the records which showed in main host screen display, the racing data of the recorded video can be brought up in APP.

Racing mode: Racing data is not written into the video, and relevant data cannot be retrieved in APP. The operation method is the same as the racing video mode, but the video will not be cut off. This mode does not interfere with video recording.

OFF state: When you choose to off this mode, the straight racing function is turned off, and the straight racing interface is no longer displayed in the main host screen, only the video interface and the data interface are displayed.

Troubleshooting

1.The racing interface does not show or the speed video cannot add watermark: Please check the status of the straight racing function in the main host setting interface, if it is "OFF", the racing interface will not be shown. If it is in "Racing mode", the racing data will not be written in the video, and the speed watermark cannot be added in the APP.

2.The straight racing function can not running: 1,Please make sure the GPS is “ON” and the signal is good 2, Please check the status of the straight racing function in the main host settings interface, if it is in "Racing video mode", please adjust the video cycling time to 3 minutes.

3.The speed suddenly drops to zero during the racing: It may be due to local GPS signal instability or interfered, please try again in an open area with good GPS signal.

倾斜角度 Tilt Angle

PART 5

倾斜角度: 当摩托车左右倾斜时会显示当前的倾斜角度(最大显示角度为70°)和实时车速,并记录最大倾斜角度和在最大倾斜角度时的实时车速。

倾斜角度校正操作: 1. 倾角校正前请确保主机与水平面的夹角在20度以内且尽量与车头仪表平行,如果超出范围可能会导致倾斜角度数据会产生一定的偏差。

2. 将摩托车推到水平地面上,打开大脚撑让摩托车与地面保持垂直,并扶正车把,确保摩托车前后轮在一条直线上。

3. 长按OK键3秒,会弹出操作菜单,按下翻键或上翻键选择“倾角校正”,短按OK键确认即可。

Tilt angle : When motorcycle leaning left/right while riding, the current angle (max. angle is 70°) and real-time speed will be displayed, the max. tilt angle and real-time vehicle speed at the max angle will be recorded.

Tilt Angle Correction: 1,During installation, please ensure that the angle between the main host and the horizontal plane is within 20 degrees and keep parallel to the front instrument as far as possible. If it is beyond the range, tilt angle data may cause data deviation.

2, Make sure motorcycle is on flat ground, keep the motorcycle with the ground at 90 degree and the handlebar upright to ensure motorcycle wheels in a straight line.

3, Long press “OK” button 3 seconds, will appear an operation menu, press “UP/Down” button to select “Tilt angle correction”, short press “OK” button to confirm.

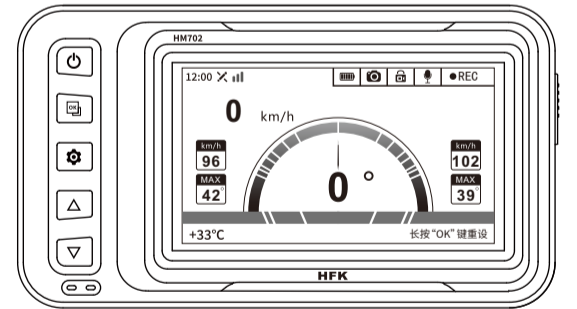
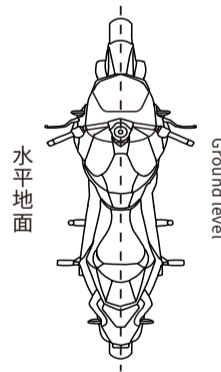

遥控器配对 Remote control matching

PART 6

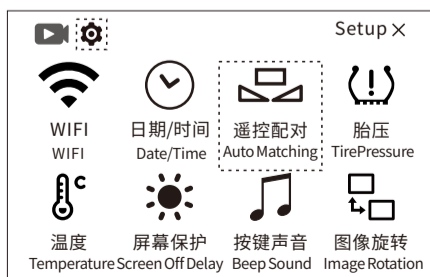
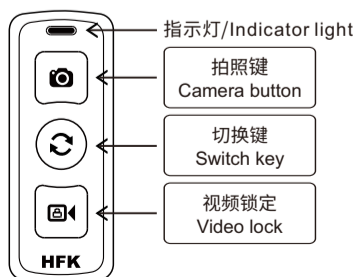

注:无线遥控器为选配设备,若有需要请另外购买。遥控器详细操作请查询遥控器说明书。

Note: wireless remote control is optional equipment, please purchase it separately if necessary. Lease refer to the remote control manual for detailed operation.

HM702与无线遥控器配对操作

1.短按HM702主机上“确认键”暂停录像,短按“设置键”两次进入“系统设置”界面,选择遥控配对内的“开始配对”选项并确认,屏幕上显示“开始配对...”。

2.同时按住遥控器上“拍照键”和“视频锁定键”,K20遥控器指示灯闪烁五次,配对成功后主机屏幕会显示“配对成功”。如配对超时请重复以上操作。

HM702 and Wireless Remote Control Matching Operation

1. Short press the “OK” button on HM702 to pause recording. Short press “Setting” twice to enter system settings interface, select “Auto Matching” and confirm.

2. Simultaneously press and hold the “Camera” & “Video Lock” on the remote control. After the K20 remote control indicator flashes 5 times, the matching is successful with words "Matching success" and the main screen will return to system settings interface .If not work, please try again.

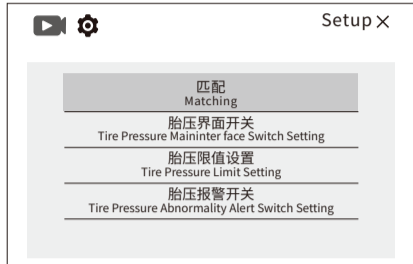
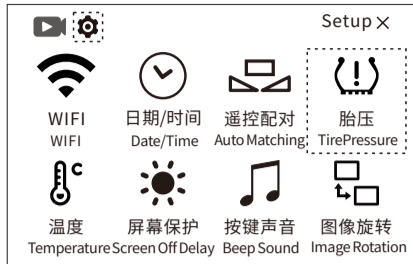

HM702与胎压监测器配对操作

- 短按HM702主机上“确认键”暂停录像，短按“设置键”两次进入“系统设置”界面，选择胎压内的“匹配”选项，选择“前轮匹配”或者“后轮匹配”并确认，屏幕上显示“前轮匹配中(后轮匹配中)···”。
 - 将胎压监测器拧到对应(前/后)轮胎的气嘴上直到拧紧，配对成功后主机屏幕会显示“前轮匹配成功(后轮匹配成功)”。
- 注: 1. 每次匹配胎压需要间隔20秒;**
2. 如配对超时请重复以上操作。

匹配: 配对胎压监测器，“前轮匹配”匹配成功后会在胎压显示界面“FW”显示相应的胎压数值；“后轮匹配”匹配成功后会在胎压显示界面“RW”显示相应的胎压数值。

胎压界面开关: 开启后主机屏幕上显示“胎压显示界面”；关闭后，主机上不显示“胎压显示界面”，默认为关闭，匹配上胎压监测器后自动打开“胎压显示界面”。若主机没有匹配胎压监测器将无法提供数据。

胎压限值设置: 用于设置胎压最高和最低的报警值，前轮胎压最高限制设置后，当胎压≥设置的限制，前轮胎压最低限制设置后，当胎压≤设置的限制，后轮胎压最高限制设置后，当胎压≥设置的限制，后轮胎压最低限制设置后，当胎压≤设置的限制，主机屏幕会显示“胎压异常，请尽快检查轮胎”提示框并伴有滴滴声(持续15秒)。

胎压报警开关: 开启后，当胎压限制设定高于设定值或低于设定值，主机屏幕会显示“胎压异常，请尽快检查轮胎”提示框并伴有滴滴声(持续15秒)；当胎压丢失时，主机屏幕会显示“胎压设备丢失”提示框并伴有滴滴声(持续15秒)，默认为关闭，匹配上胎压监测器后自动打开胎压报警。若主机没有匹配胎压监测器将无法报警。

HM702 and Tire pressure detector Matching Operation

- Short press the “OK” button on HM702 to pause recording. Short press “Setting” twice to enter system settings interface, select the "matching" option within the tire pressure, select "front wheel matching" or "rear wheel matching" and confirm. The screen will display "front wheel matching (rear wheel matching) ···".
 - Screw the tire pressure monitor onto the corresponding (front/rear) tire nozzle until it is tightened. After successful pairing, the host screen will display "Front wheel matching successful (rear wheel matching successful)".
- Note: 1. Each tire pressure matching requires a 20 second interval; If pairing timeout occurs, please repeat the above operation.**

Matching: Paired with tire pressure monitors, after successful "front wheel matching", the corresponding tire pressure value will be displayed on the tire pressure display interface "FW"; After the "rear wheel matching" is successful, the corresponding tire pressure value will be displayed on the tire pressure display interface "RW".

Tire Pressure Maininter face Switch Setting: After being turned on, the host screen displays the "tire pressure display interface"; After shutdown, the "tire pressure display interface" will not be displayed on the host, but will default to closed. After matching with the tire pressure monitor, the "tire pressure display interface" will automatically open. If the host does not match the tire pressure monitor, it will not be able to provide data normally.

Tire pressure limit setting: used to set the alarm values for the highest and lowest tire pressures. After setting the maximum and lowest front tire pressure limits, when the tire pressure is greater than or equal to the set limit, when the front tire pressure is lower than or equal to the set limit, when the rear tire pressure is higher than or equal to the set limit, and when the rear tire pressure is lower than or equal to the set limit, the host screen will display "Abnormal tire pressure, please check the tires as soon as possible" Prompt box accompanied by beeping sound (lasting for 15 seconds).

Tire Pressure Abnormality Alert Switch Setting: After being turned on, when the tire pressure limit is set above or below the set value, the host screen will display a "Tire pressure abnormal, please check the tires as soon as possible" prompt box accompanied by a beep sound (lasting for 15 seconds); When the tire pressure is lost, the host screen will display a "tire pressure device lost" prompt box accompanied by a beep sound (lasting for 15 seconds), which defaults to off. After matching with the tire pressure monitor, the tire pressure alarm will automatically turn on. If the host does not match the tire pressure monitor, it will not be able to alarm.

HM702连接手机APP

- 在录像状态下长按HM801P 设置键，主机屏幕变为蓝色并显示: SSIDXX-XXXX, PWA2: 00000000。
- 在手机上选择名称为“HM702-xxxx”的WiFi信号连接，初始密码8个0，然后打开HFK手机APP即可成功连接，主机屏幕上也会显示“WiFi连接成功”。

HM702 APP connection

- Long press “Setting” while recording, main screen will be in blue and show: SSIDXX-XXXX, PWA2: 00000000.
- Select the name of WIFI “HM702-xxxx” on your phone to connect, initial password is:00000000, then turn on HFK APP, it will connect successfully, the main screen will show “WIFI connection successful”.



Android 手机文件下载

点击“文件”进入“eMMC/TF文件夹”界面(默认为“eMMC”，若插入TF卡，可切换到“TF”)，点击文件名后面的“下载”按钮直接下载。也可以点击文件预览，在预览界面进行下载操作。退出APP后可在手机“文件管理”查看已下载的文件。

Android Download

Select “Folder” enter in “eMMC/TF Folder” (default in “eMMC”, if insert a TF card, it can switch to “TF”), download the file. Or you can download the file directly in preview. Then back to phone “Files” to check the downloaded files.

录像界面/Video

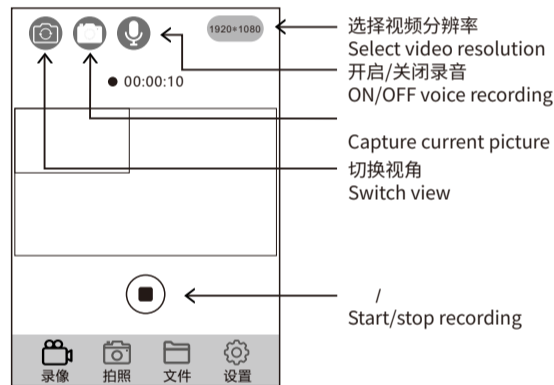

拍照界面/Camera

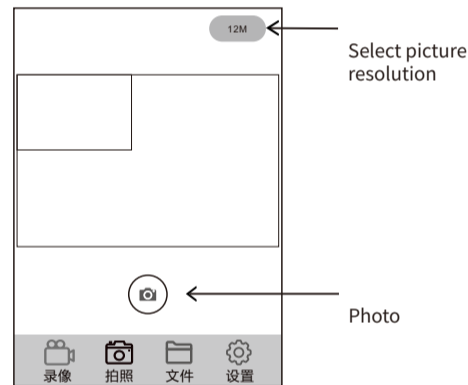

扫码下载APP
Scan QR code
and download App
(Android/iOS)

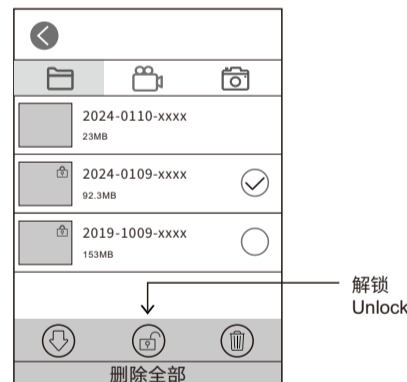
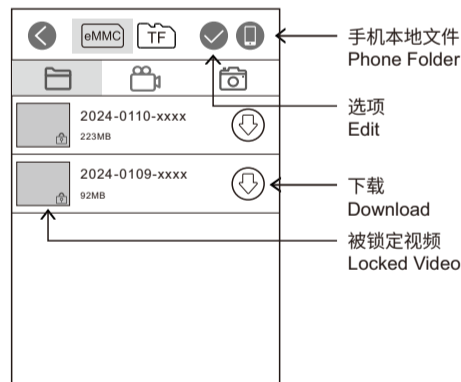

解锁被锁定视频

点击“文件”进入“eMMC/TF文件夹”界面，点击“选项”按钮进入文件选择界面，选好需要解锁的文件后点击“解锁”按钮即可。

Unlock the locked videos

Select “Folder” enter in “eMMC/TF Folder”, click “Edit” to choose the files which need to unlock.

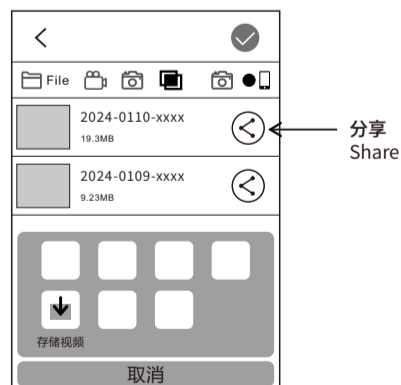
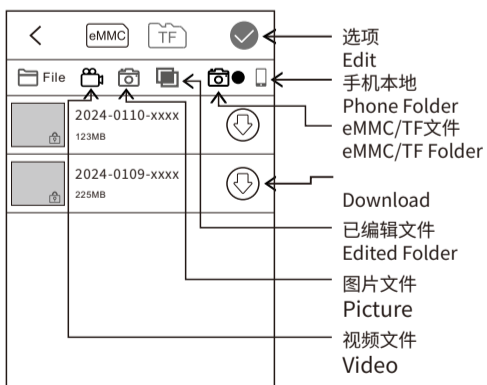

iOS

iOS 手机文件下载

- 点击“文件”进入“eMMC/TF文件夹”界面(默认为“eMMC”，若插入TF卡，可切换到“TF”)，点击文件名后面的“下载”按钮直接下载，也可以点击文件预览，在预览界面进行下载操作。
- 点击“手机本地文件”按钮，找到之前下载到手机的文件。点击文件后面的“分享”按钮，在弹出框内选择“存储视频”或“存储图像”，将文件保存到手机相册，退出APP后在手机“相册”查看。
- 剪辑或添加水印的视频文件保存在“已编辑文件夹”，可直接分享到社交平台(须断开WiFi连接，并联网)，也可下载到手机本地，操作同上。

iOS Download

- Select “Folder” enter in “eMMC/TF Folder” (default in “eMMC”, if insert a TF card, it can switch to “TF”), download the file you need, and also can download the file directly in preview
- Select “Phone Folder”, you can view the downloaded files on your phone. Select “Share” to “Save the video” or “Save the Photo”. Then back to phone “Photos” to check the downloaded files.
- Edited videos saved in “Edited Folder”, they can be shared directly to social media(Keep phone on line, if cannot share, please disconnect the WIFI between phone and DVR). They also can download to the phone folder, same operation as above.

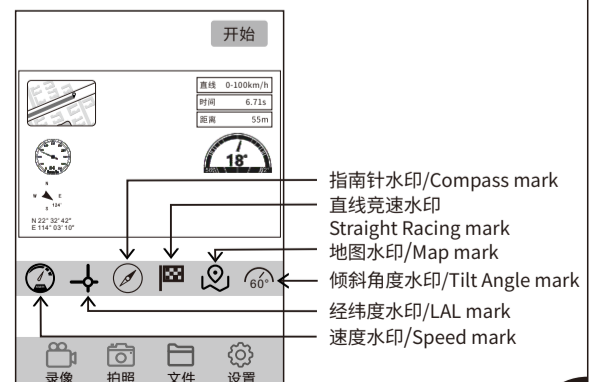
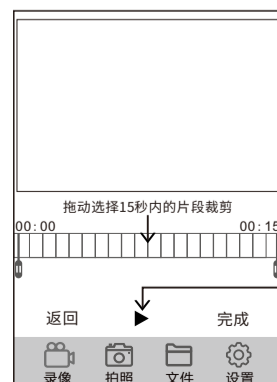
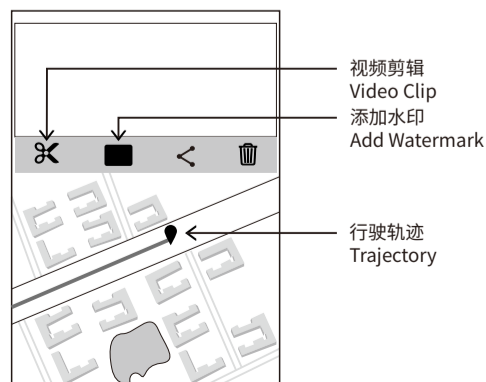
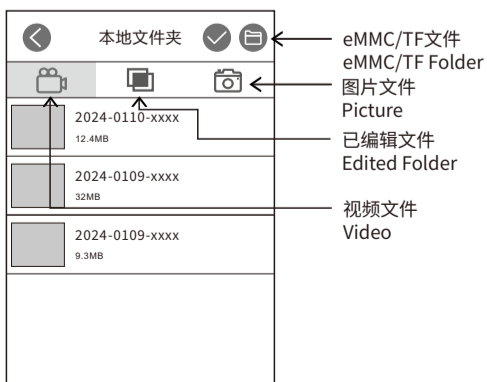

视频剪辑和添加水印

- 1.点击“文件”进入“eMMC/TF文件夹”界面,选择所需视频点击文件名后面的“下载”按钮直接下载(也可在预览界面中下载)。
- 2.点击“本地文件”按钮,找到之前下载到手机的文件,点击该文件进入播放界面,点击“视频剪辑”或“添加水印”按钮即可进入相应操作界面。

Video Clip&Add watermark

- 1.Select “Folder” enter in “eMMC/TF Folder”, download the file you needed(also can download in preview).
- 2.Select “Phone Folder”,find the downloaded file, play the video and click “Video Clip” or “Add watermark” to edit the file.

视频剪辑

拖动屏幕中的“视频进度条”,选择所需视频片段,点击“播放”按钮可预览所选视频片段,选好点击“完成”即可。拖动“视频条”两端滑块,可缩短视频时间。剪辑好的视频文件会存储在“已编辑文件夹”。

Video Clip

Drag the progress bar in the video, select you needed part. Click “Play” to preview the selected video clip, click “Done” to finish. Drag the sliders at both ends of the video to reduce the video time. The clipped video files will be stored in the “Edited Folder”.

添加水印

- 1.点击屏幕上“直线竞速”、“速度”、“经纬度”、“指南针”“地图”或“倾斜角度”按钮即可添加或取消相应的水印。
- 2.拖动水印,放置到合适位置。
- 3.点击“开始”按钮,开始视频合成。合成好的会存储在“已编辑文件夹”。

Add watermark

- 1.Click the “Straight Racing mark” / “Speed mark” / “Longitude & latitude mark” / “Compass mark” / “Map mark” or “Tilt Angle mark” button on the screen to add or cancel the mark.
- 2.Drag the mark and place it in the appropriate position.
3. Click the “Start” button to start the video composition. The synthesized ones will be stored in the “Edited Folder”.

常见故障处理 Troubleshooting

PART 9

提示:本系统支持最大512GB TF卡储存,为了保证录像正常,建议使用正牌储存卡,由于记录系统不停读写数据,必须使用 ④ ③ 及以上标准的高速卡(读取速度100Mb/s,写入速度60Mb/s以上),同时系统开启时切勿插拔TF卡,以免造成储存卡的损坏。

1. 摩托车启动后不开机:请检查线路连接是否正常。
2. 按开机键不能开机:请检查线路连接是否正常。
3. 开机后不能录像/不能拍照/不能锁定视频:请检查是否插入TF卡或需格式化TF卡;TF卡格式化后若问题还存在,请重插入TF卡或再格式化TF卡或者更换新卡解决。
4. 主机上前(F)或后(R)摄像头没有显示,请对换摄像头排查。例如:前(F)摄像头没有显示,对换摄像头后变为后路(R),此时后路(R)摄像头没有显示则是该摄像头本身存在问题,请更换新的摄像头。
5. 前(F)、后(R)摄像头都没有显示:请检查摄像头线连接是否正常。
6. 录像变模糊:请检查镜头是否有灰尘,请擦拭镜头。
7. 录像没有声音,请检查麦克风是否关闭。
8. 正常行驶时很多视频被锁定:请调节重力感应灵敏度,默认为综合路面,请调为越野路面。
9. 摩托车碰撞时记录仪文件不锁定:请检查重力感应调节开关是否在开的状态.如果重力感应是开的,请将重力感应的级别往城市路面调节。
10. WIFI连接不正常:请检查WIFI是否开启,开启WIFI后,屏幕会显示SSID: XX-XXXXX。PWA2: 00000000 (初始密码为8个0)。连接WIFI机器显示蓝屏.并有WIFI已连接.连接WIFI时请将手机蓝牙关闭。
11. 出现死机等异常现象:请按复位键RESET。
12. 主机显示和录像的视频会出现条纹电磁干扰或者紫纹电磁干扰:1,请检查摩托车火花塞型号,请使用R级电阻式火花塞。2,检查摄像头走线扎线是否存在问题,走线时请平顺走线,不要折到并保留一定余量,扎线时请不要绑的太紧或与车壳挤压太紧。

Note: This system max support for 512GB TF card. In order to make sure video recording normally, we suggest to use brand TF card. Because the recording system keep reading and writing data, so please must be use high speed ④ ③ TF card or above (reading speed of 100Mb/s,writing speed of 60Mb/s). When the DVR is working, please do not remove the TF card, it may cause the TF card damaged.

- 1.After start on the motorcycle but the DVR cannot turn on, first check power connection if normal.
- 2.Press “ON” button but DVR cannot turn on, please check the power connection if normal.
- 3.If DVR cannot recording/take pictures/lock videos, please check if you inserted the TF card or need to format TF card. If the problem is still on after formatting the TF card, please re-insert the TF card or re-format or replace a new card.
- 4.Main host “F” -front camera(“B” -rear camera) has no display image, please switch front(or rear) camera to check. For example: Front camera has no image, switch “F” to “B” ,but “B” still no display, then make sure “F” camera with problem, please change a new one.
5. “F” and “B” both have no display image, check the cameras connection if right.
- 6.If the video comes blurry, please check the lens if with dust, and wipe them clean.
- 7.If the recording video has no voice, please check the microphone if “ON” .
- 8.During normal riding when you find videos locked: Please adjust the G-sensor sensitivity. The default is integrated general road, please select to Bumpy mode.
- 9.Motorcycle Collision but recording video unlocked: Please check if the G-sensor is “ON” , if it is on, please set the sensitivity mode in Urban road.
- 10.WIFI connection is abnormal: Check the WIFI if “ON” .After connecting WIFI, the display will show: “SSID: XX-XXXXX. PWA2:00000000” (Initial password is 00000000).Connecting WIFI the screen display is in blue with words” WIFI connected” .When connecting WIFI please turn off the cellphone Bluetooth.
- 11.If the DVR crashed, please press “RESET” and try again.
- 12.Display screen or recording video if have stray electromagnetic interference or purple-grained electromagnetic interference: 1, Please check the motorcycle spark plug model, please use R-rated resistive spark plug. 2, Check if there has any problem with the cable lines or binding of the cameras. Please straighten the cable don’ t fold them up and keep a certain margin. Do not tie them too hard or squeeze too tightly with the motorcycle shell.

FCC STATEMENT

PART 10

This device complies with part 15 of the FCC Rules. Operation is subject to the following two conditions: (1)This device may not cause harmful interference, and (2) this device must accept any interference received, including interference that may cause undesired operation.

This equipment has been tested and found to comply with the limits for a Class B digital device, Pursuant to part 15 of the FCC Rules. These limits are designed to provide reasonable protection against harmful interference in a residential installation. This equipment generates, uses and can radiate radio frequency energy and, if not installed and used in accordance with the instructions, may cause harmful interference to radio communications. However, there is no guarantee that interference will not occur in a particular installation. If this equipment does cause harmful interference to radio or television reception, which can be determined by turning the equipment off and on, the user is encouraged to try to correct the interference by one or more of the following measures:

- Reorient or relocate the receiving antenna.
- Increase the separation between the equipment and receiver.
- Connect the equipment into an outlet on a circuit different from that to which the receiver is connected.
- Consult the dealer or an experienced radio/TV technician for help.

Caution: Any changes or modifications to this device not explicitly approved by manufacturer could void your authority to operate this equipment.

This equipment complies with FCC radiation exposure limits set forth for an uncontrolled environment. This equipment should be installed and operated with minimum distance 20cm between the radiator and your body.