



# Antenna Datasheet

**Product OC (Antenna Only):** YC0009AA

**Product OC (Antenna + Rectangular EVB):** YC0009AAEVB

**Version:** 2.0

**Date:** 2024-01-11

**Status:** Released

**Product Name:** Wi-Fi Ceramic SMD Antenna

**Key Features:**

Frequency band: 2400–2500 MHz

Efficiency: Up to 69.9 %

Dimensions: 3.2 mm × 1.6 mm × 0.5 mm

RoHS Compliant

# Overview

Quectel Wi-Fi 2.4G antenna covers 2.4–2.5 GHz bands, fully satisfying customers' requirements for Wi-Fi/Zigbee/BT antennas. There are various antenna types, including built-in FPC/PCB antenna, ceramic patch antenna, and other external antennas of different shapes or sizes. The antenna performance meets the customers' demands for efficiency, gain, and radiation and ensures the superior experience of the customers' products in use.

# Contents

<b>Overview</b> .....	<b>1</b>
<b>Contents</b> .....	<b>2</b>
<b>1 Specification</b> .....	<b>3</b>
1.1. Electrical.....	3
1.2. Mechanical & Environmental .....	4
<b>2 Drawing</b> .....	<b>5</b>
2.1. Antenna.....	5
2.2. Rectangular EVB.....	6
<b>3 Detailed Performance</b> .....	<b>7</b>
3.1. S-Parameter Test .....	7
3.1.1. VSWR.....	7
3.1.2. Return Loss .....	8
3.2. Radiation Performance Test.....	9
3.2.1. Efficiency .....	9
3.2.2. Average Gain .....	10
3.2.3. Peak Gain.....	11
3.2.4. 3D & 2D Radiation Pattern.....	12
<b>4 Schematic Symbol and Pin Definition</b> .....	<b>14</b>
<b>5 Transmission Line</b> .....	<b>15</b>
<b>6 Recommended PCB Layout</b> .....	<b>16</b>
<b>7 Matching Circuit</b> .....	<b>17</b>
<b>8 Soldering Temperature</b> .....	<b>18</b>
<b>9 Reflow Profile</b> .....	<b>19</b>
<b>10 Packaging</b> .....	<b>20</b>
<b>Contact Us</b> .....	<b>22</b>
<b>Legal Notices</b> .....	<b>23</b>
<b>Revision History</b> .....	<b>25</b>

# 1 Specification

Test Condition: Assembled On 91 mm × 51 mm EVB

## 1.1. Electrical

Electrical	
Frequency Range	2400–2500 MHz
Impedance	50 Ω
Polarization	Linear
Radiation Pattern	Omni-directional

Electrical - Detail										
SPEC	Band	Band	B71	B12 /B13 /B28	B5 /B8 /B26	B1 /B2 /B3	B40	Wi-Fi 2G	B38 /B41	
		Freq. (MHz)	600– 698	700– 790	790– 960	1700– 2170	2300– 2400	2400– 2500	2500– 2690	
Max VSWR			-	-	-	-	-	2.3	-	
Max Return Loss (dB)			-	-	-	-	-	-8.2	-	
AVG Eff. (%)			-	-	-	-	-	64.0	-	
AVG Gain (dB)			-	-	-	-	-	-2.0	-	
Max Peak Gain (dBi)			-	-	-	-	-	0.1	-	
VSWR			≤2.3							
Return Loss			≤-8.2 dB							
Peak Gain			≤0.1 dBi							

## 1.2. Mechanical & Environmental

Mechanical	
Antenna Size	3.2 mm × 1.6 mm × 0.5 mm
Material & Color	Ceramic & Natural
Antenna Weight	Typ. 0.01 g
Mounting Type	SMD
Recommended EVB Size	Rectangular EVB: 91 mm × 51 mm
Environmental	
Operation Temperature	-40 °C to +85 °C
Storage Temperature	-40 °C to +85 °C
RoHS Compliant	Yes

# 2 Drawing

## 2.1. Antenna

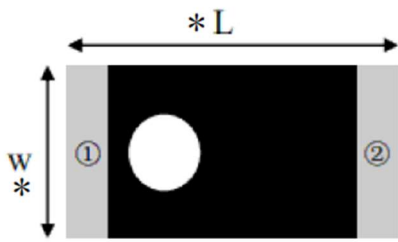

( Top View )

Number	Terminal Name
①	INPUT
②	NC



( Bottom View )

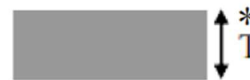

( Side View )

Symbols	L	W	T	A
Dimensions	3.2+/-0.2	1.6+/-0.2	0.5+/-0.1	0.4+/-0.1

All dimensions are in mm

## 2.2. Rectangular EVB

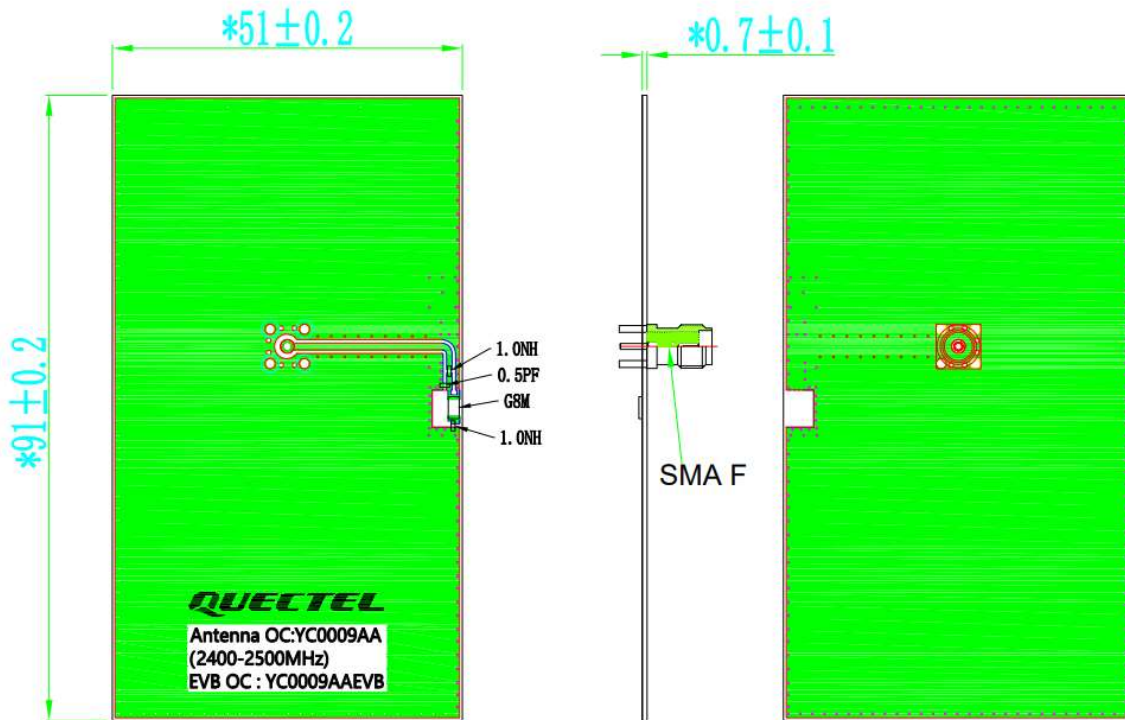

All dimensions are in mm.

# 3 Detailed Performance

## 3.1. S-Parameter Test

### 3.1.1. VSWR

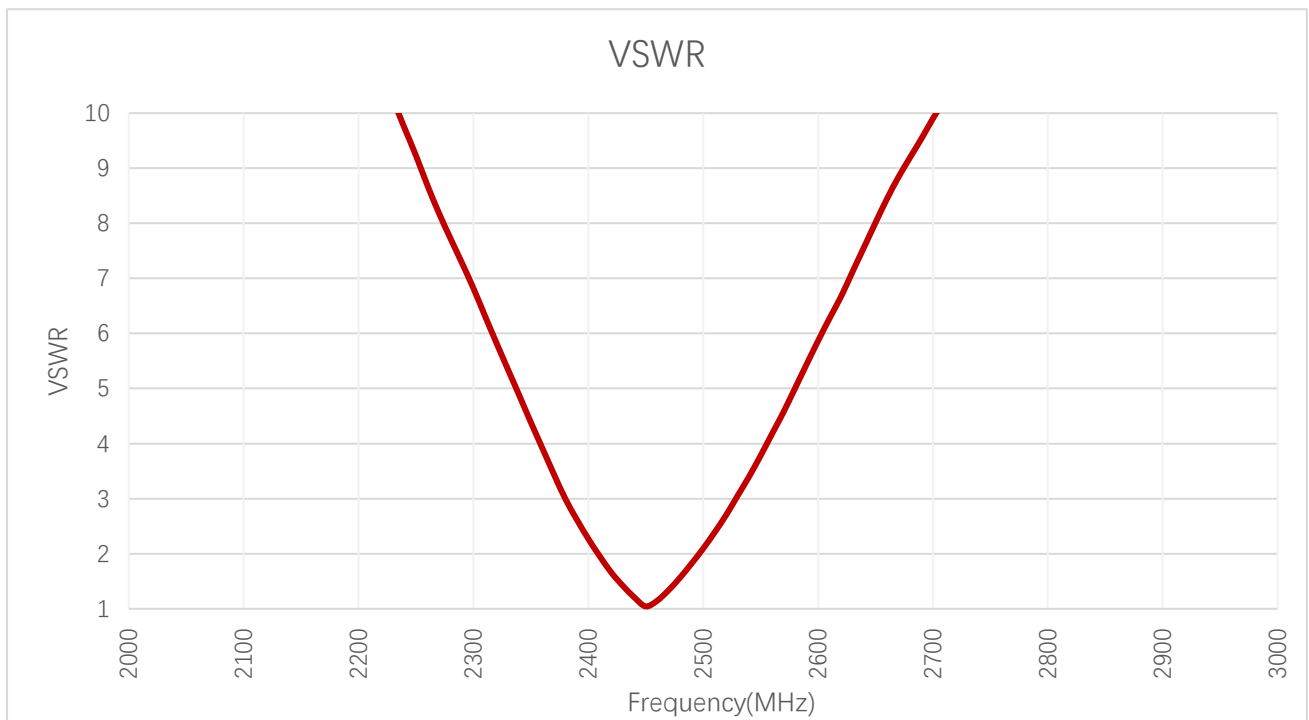

**VSWR**

Frequency (MHz)	2400	2450	2500	5150	5500	5850	5925	6325	6725	7125
On 91 × 51 mm EVB	2.3	1.0	2.1	-	-	-	-	-	-	-



**3.1.2. Return Loss**

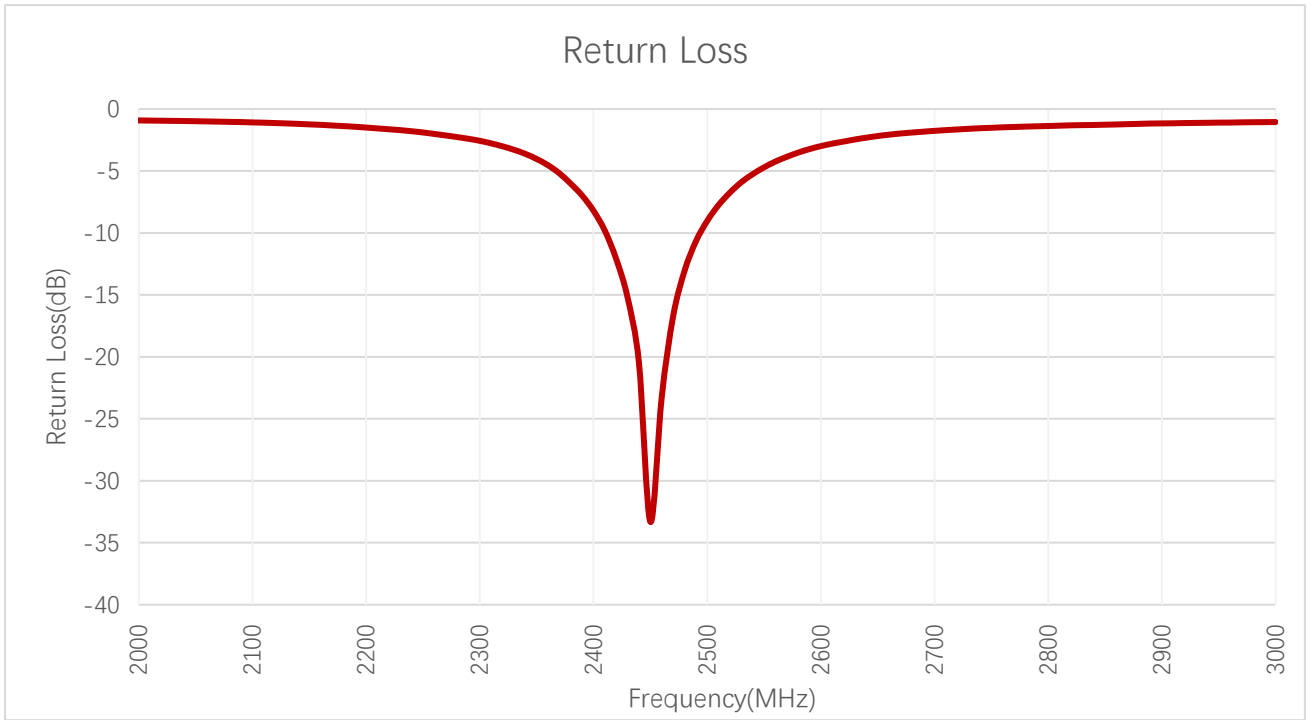

**Return Loss (dB)**

Frequency (MHz)	2400	2450	2500	5150	5500	5850	5925	6325	6725	7125
On 91 × 51 mm EVB	-8.2	-33.3	-9.0	-	-	-	-	-	-	-

### 3.2. Radiation Performance Test

#### 3.2.1. Efficiency

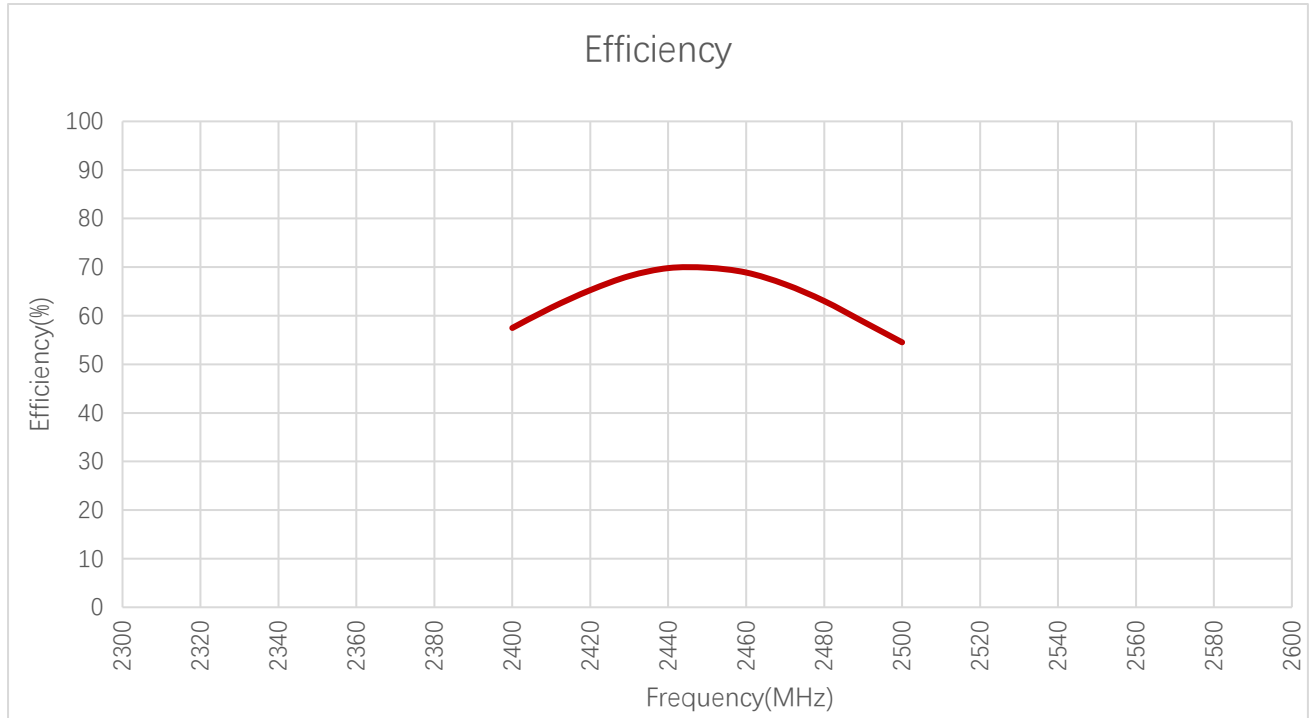

**Efficiency (%)**

Frequency (MHz)	2400	2450	2500	5150	5500	5850	5925	6325	6725	7125
On 91 × 51 mm EVB	57.5	69.9	54.5	-	-	-	-	-	-	-

**3.2.2. Average Gain**

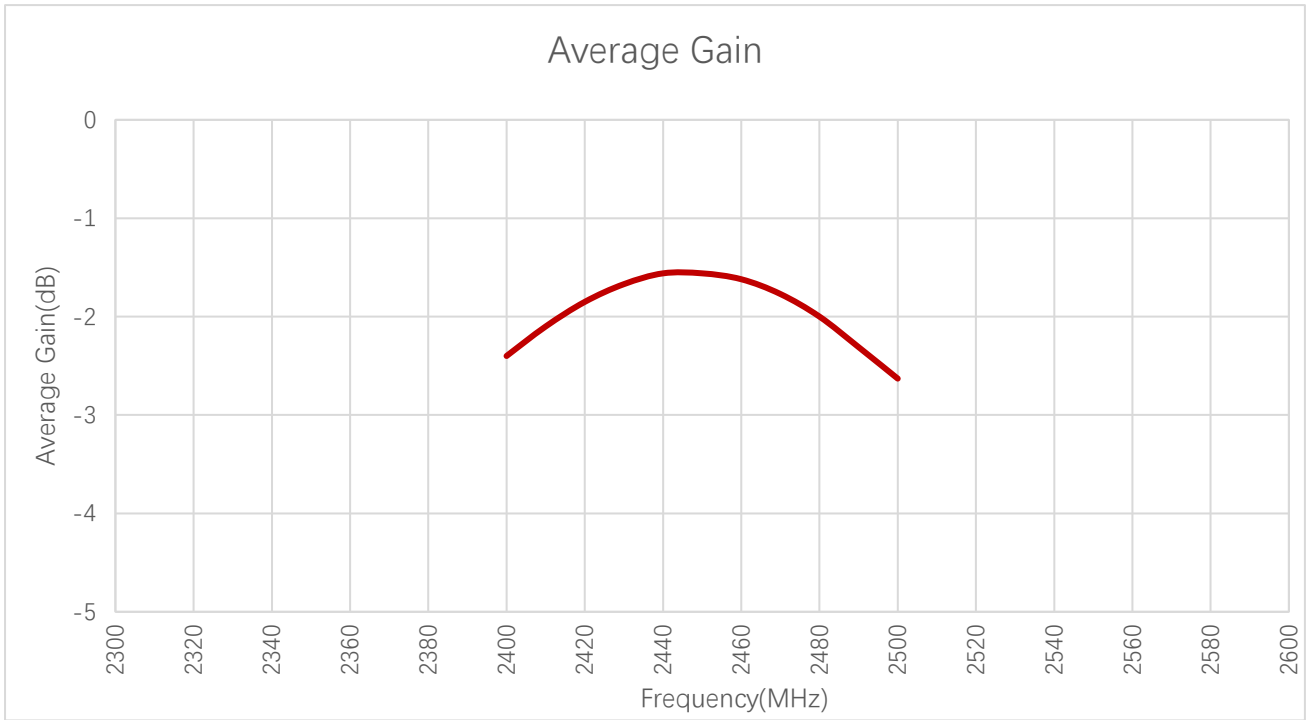

**Average Gain (dB)**

Frequency (MHz)	2400	2450	2500	5150	5500	5850	5925	6325	6725	7125
On 91 × 51 mm EVB	-2.4	-1.6	-2.6	-	-	-	-	-	-	-

**3.2.3. Peak Gain**

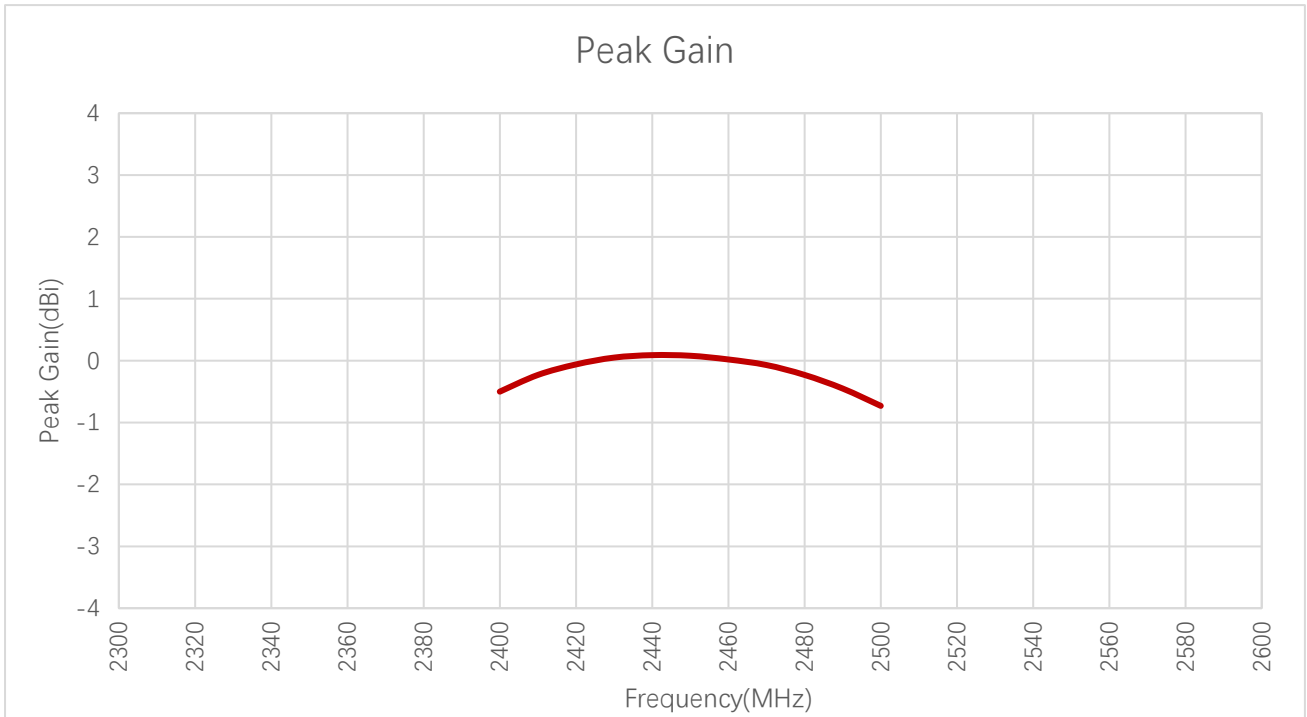

**Peak Gain (dBi)**

Frequency (MHz)	2400	2450	2500	5150	5500	5850	5925	6325	6725	7125
On 91 × 51 mm EVB	-0.5	0.1	-0.7	-	-	-	-	-	-	-

### 3.2.4. 3D & 2D Radiation Pattern

- Test Status: Assembled on 91 mm × 51 mm EVB
- Test Chamber: GL-S-1

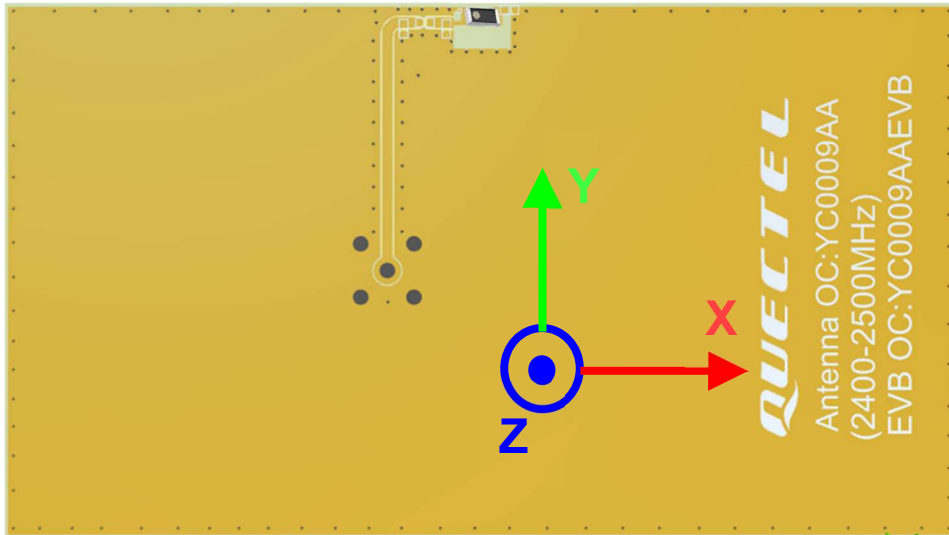

● Wi-Fi

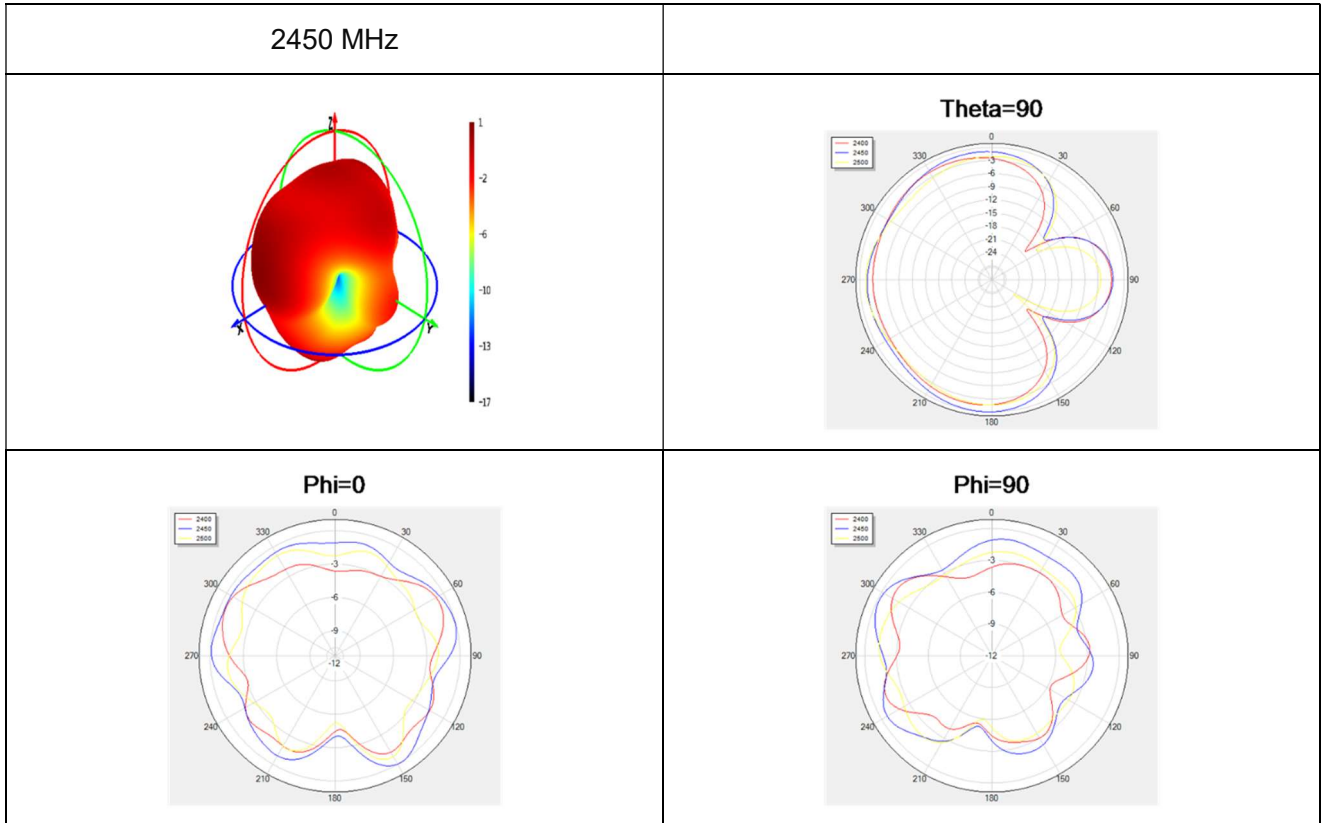

# 4 Schematic Symbol and Pin Definition

- The pin assignment for the antenna is as follows.
- The circuit symbol for the antenna is shown below. The antenna has 2 pins, only one of which works. All other pins are for mechanical strength.

Pin	Description
1	Return / GND
2	Feed

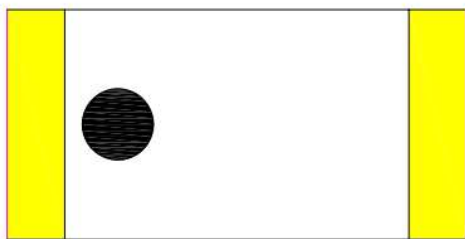

TOP

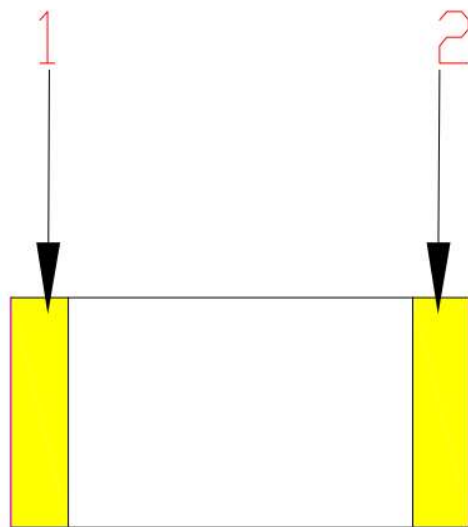

BOTTOM

## 5 Transmission Line

The characteristic impedance of all transmission lines shall be designed as 50  $\Omega$ .

- The length of the transmission lines should be kept as short as possible.
- Any other part of the RF system, such as transceiver, power amplifiers, etc., shall also be designed with an impedance of 50  $\Omega$ .

Once the material for the PCB has been chosen (PCB thickness and dielectric constant), a coplanar transmission line can easily be designed using any of the commercial software packages for transmission line design. For the chosen PCB thickness, copper thickness and substrate dielectric constant, the program will calculate the appropriate transmission line width and gaps on either side of the track so the characteristic impedance of the coplanar transmission is 50  $\Omega$ .



# 6 Recommended PCB Layout

The host PCB must be designed using the PCB footprint shown with the correct clearances. An example of the PCB layout shows the antenna footprint. Please note this clearance area is critical to the performance of the antenna and must be applied through all layers of the PCB.

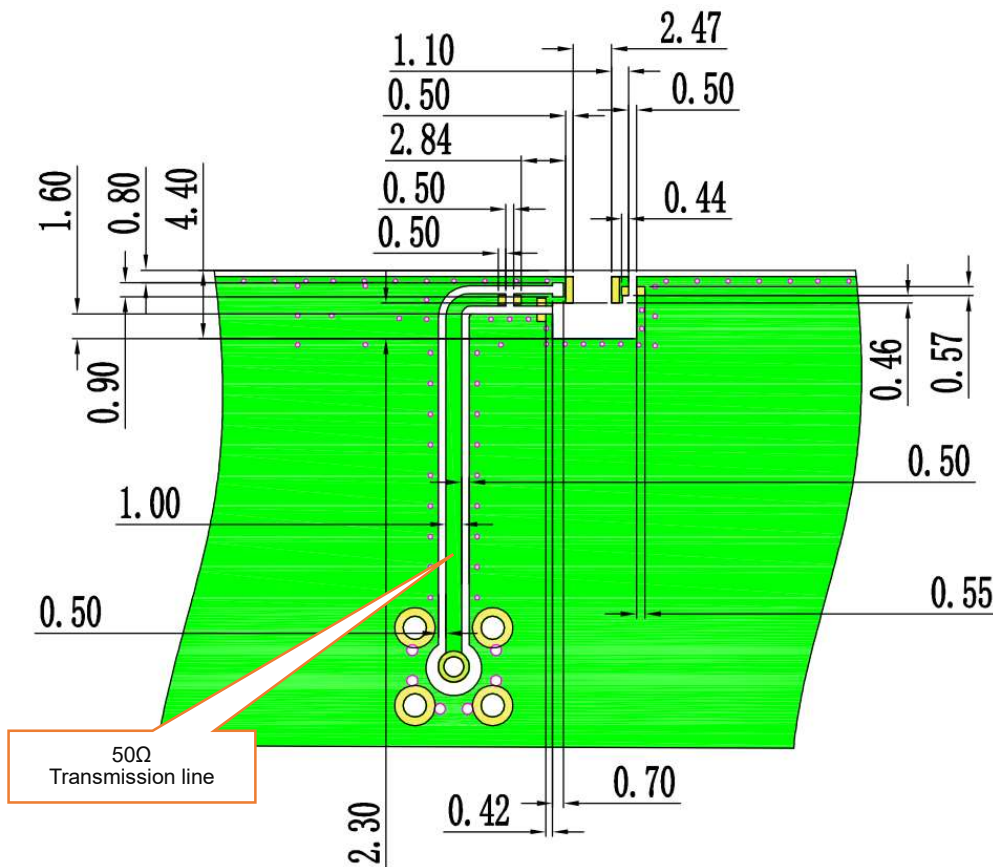

All dimensions are in mm.

# 7 Matching Circuit

Demo Board Top View

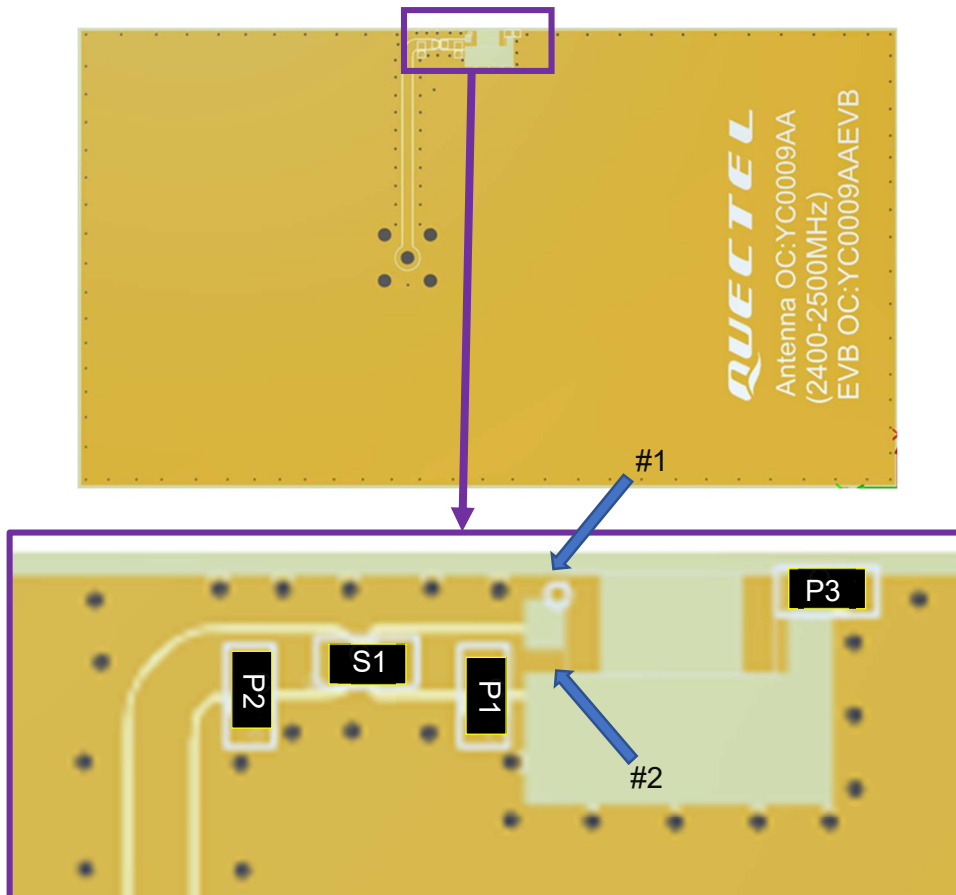

	P1	S1	P2	P3
Default Matching	0.5pF	1nH	NC	1nH
Tolerance	±5 %	±5 %	N/A	±5 %

Pin #	Description
1	Return / GND
2	Feed

# 8 Soldering Temperature

Phase	Profile Features	PB-Free Assembly
RAMP-UP	Avg. Ramp-up Rate (T <sub>smax</sub> to T <sub>p</sub> )	3 °C/second (Max.)
PREHEAT	Temperature Min (T <sub>smin</sub> ) Temperature Max (T <sub>smax</sub> ) Time (t <sub>smin</sub> to t <sub>smax</sub> )	150 °C 190 °C 110 seconds (Max.)
REFLOW	Temperature (TL) Total Time above TL (tl)	220 °C 90 seconds (Max.)
PEAK	Temperature (T <sub>p</sub> )	230–250 °C
RAMP-DOWN	Rate	-1 °C/second (Max.)

# 9 Reflow Profile

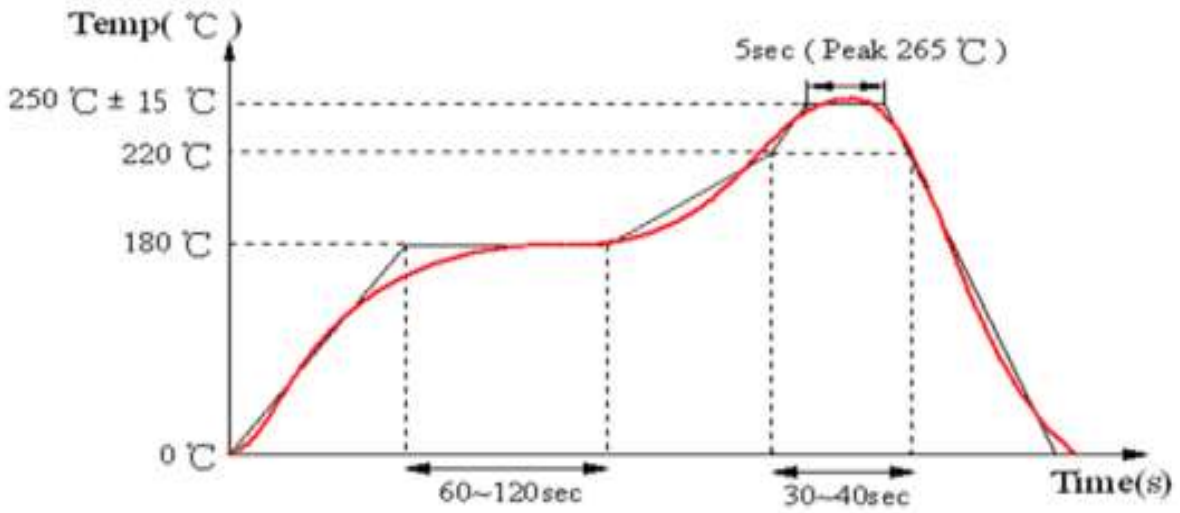

# 10 Packaging

Step	Packaging Picture / 2D Picture	Description
1		Reel
2		(6000 PCS Antennas / Reel)
3		Put the product into a vacuum bag and pump the true hole.

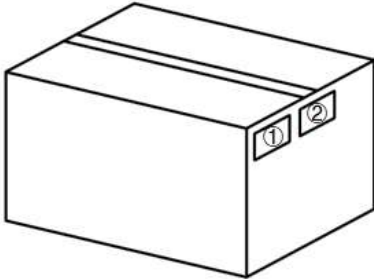
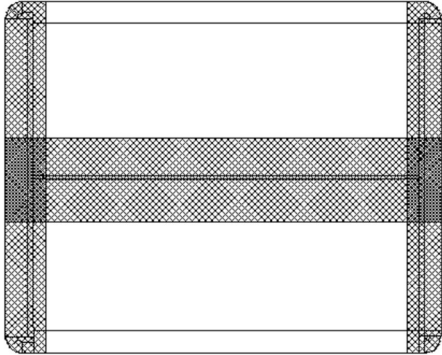
<p>4</p>		<p>(10 Reels / Carton Box) (60000 PCS Antennas / Carton Box)</p> <p><u>Carton Size:</u> <u>L × W × H = 300 × 250 × 200 mm</u></p>
<p>5</p>		<p><b>Position for Attaching Labels</b></p> <p>① Carton Label ② Quality Label</p>
<p>6</p>		<p><b>Sealing Cartons</b> “I” type sealing cartons</p>

## Contact Us

**At Quectel, our aim is to provide timely and comprehensive services to our customers. If you require any assistance, please contact our headquarters:**

**Quectel Wireless Solutions Co., Ltd.**

Building 5, Shanghai Business Park Phase III (Area B), No.1016 Tianlin Road, Minhang District, Shanghai 200233, China

Tel: +86 21 5108 6236

Email: [info@quectel.com](mailto:info@quectel.com)

**Or our local offices. For more information, please visit:**

<http://www.quectel.com/support/sales.htm>.

**For technical support, or to report documentation errors, please visit:**

<http://www.quectel.com/support/technical.htm>.

Or email us at: [support@quectel.com](mailto:support@quectel.com).

# Legal Notices

We offer information as a service to you. The provided information is based on your requirements and we make every effort to ensure its quality. You agree that you are responsible for using independent analysis and evaluation in designing intended products, and we provide reference designs for illustrative purposes only. Before using any hardware, software or service guided by this document, please read this notice carefully. Even though we employ commercially reasonable efforts to provide the best possible experience, you hereby acknowledge and agree that this document and related services hereunder are provided to you on an “as available” basis. We may revise or restate this document from time to time at our sole discretion without any prior notice to you.

## Use and Disclosure Restrictions

### License Agreements

Documents and information provided by us shall be kept confidential, unless specific permission is granted. They shall not be accessed or used for any purpose except as expressly provided herein.

### Copyright

Our and third-party products hereunder may contain copyrighted material. Such copyrighted material shall not be copied, reproduced, distributed, merged, published, translated, or modified without prior written consent. We and the third party have exclusive rights over copyrighted material. No license shall be granted or conveyed under any patents, copyrights, trademarks, or service mark rights. To avoid ambiguities, purchasing in any form cannot be deemed as granting a license other than the normal non-exclusive, royalty-free license to use the material. We reserve the right to take legal action for noncompliance with abovementioned requirements, unauthorized use, or other illegal or malicious use of the material.

### Trademarks

Except as otherwise set forth herein, nothing in this document shall be construed as conferring any rights to use any trademark, trade name or name, abbreviation, or counterfeit product thereof owned by Quectel or any third party in advertising, publicity, or other aspects.

### Third-Party Rights

This document may refer to hardware, software and/or documentation owned by one or more third parties (“third-party materials”). Use of such third-party materials shall be governed by all restrictions and obligations applicable thereto.



We make no warranty or representation, either express or implied, regarding the third-party materials, including but not limited to any implied or statutory, warranties of merchantability or fitness for a particular purpose, quiet enjoyment, system integration, information accuracy, and non-infringement of any third-party intellectual property rights with regard to the licensed technology or use thereof. Nothing herein constitutes a representation or warranty by us to either develop, enhance, modify, distribute, market, sell, offer for sale, or otherwise maintain production of any our products or any other hardware, software, device, tool, information, or product. We moreover disclaim any and all warranties arising from the course of dealing or usage of trade.

## Privacy Policy

To implement module functionality, certain device data are uploaded to Quectel's or third-party's servers, including carriers, chipset suppliers or customer-designated servers. Quectel, strictly abiding by the relevant laws and regulations, shall retain, use, disclose or otherwise process relevant data for the purpose of performing the service only or as permitted by applicable laws. Before data interaction with third parties, please be informed of their privacy and data security policy.

## Disclaimer

- a) We acknowledge no liability for any injury or damage arising from the reliance upon the information.
- b) We shall bear no liability resulting from any inaccuracies or omissions, or from the use of the information contained herein.
- c) While we have made every effort to ensure that the functions and features under development are free from errors, it is possible that they could contain errors, inaccuracies, and omissions. Unless otherwise provided by valid agreement, we make no warranties of any kind, either implied or express, and exclude all liability for any loss or damage suffered in connection with the use of features and functions under development, to the maximum extent permitted by law, regardless of whether such loss or damage may have been foreseeable.
- d) We are not responsible for the accessibility, safety, accuracy, availability, legality, or completeness of information, advertising, commercial offers, products, services, and materials on third-party websites and third-party resources.

***Copyright © Quectel Wireless Solutions Co., Ltd. 2024. All rights reserved.***

# Revision History

Version	Date	Author	Note
-	2020-09-20	Kenny YIN	Creation of the document
1.0	2020-09-20	Kenny YIN	First official release
1.1	2021-01-12	Kenny YIN	Updated the antenna image (Chapter 2).
1.2	2021-06-25	Aria CHU	Updated VSWR values (Chapter 3).
1.3	2021-07-25	Kenny YIN	Updated package quantity (Chapter 8).
1.4	2021-09-28	Aria CHU	Added the new OC YC0009AAEVB on the cover.
1.5	2021-11-30	Aria CHU	Updated the product description (Chapter 1).
1.6	2022-03-12	Aria CHU	Updated the data (Chapter 4.5).
1.7	2022-04-02	Aria CHU	Updated the data (Chapter 4.5).
1.8	2023-07-21	David LIU	Updated the packaging (Chapter 8).
2.0	2024-01-11	Tina GAN/ Lucky FENG/ David LIU/ Vinnie LIU	<ol style="list-style-type: none"><li>1. Numerous changes were made to this document. It should be read in its entirety.</li><li>2. Updated the template.</li></ol>

**QUECTEL**

[www.quectel.com](http://www.quectel.com)