

Antenna Specification

Specifications

Summary

ITEM	SPEC.	
Model Name	IBM 2.4 GHz	
Center Frequency	2405MHz	-3.04 dBi
	2441 MHz	-2.39dBi
	2475 MHz	-2.95 dBi
MAX. GAIN	-2.39 dBi	
Polarization	Horizontal	
Azimuth Beam Pattern	Omni-directional	
Impedance	50 Ω	
Antenna Length	3.78cm	

Manufacture:Dongguan Kingsheng Electronics & Technology Co.,Ltd

Applicant Address:Build 39,Arising Sun Industrial City, Lincun Village,

Tangxia Town,Dongguan, Guangdong, China

Antenna Photo & Length (mm)

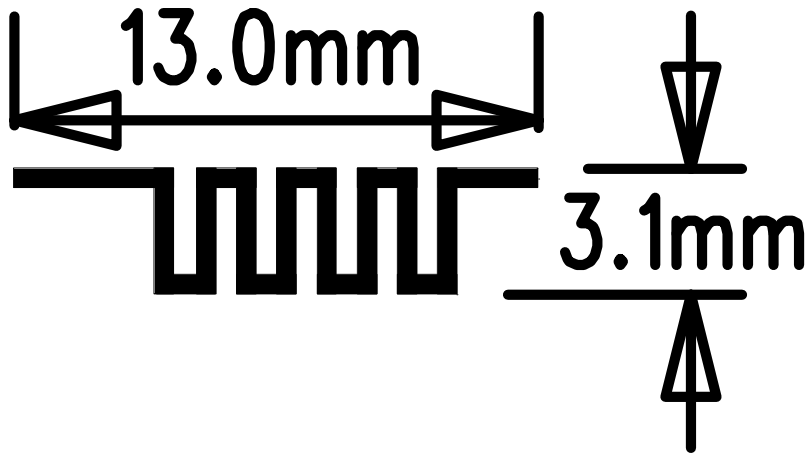

1.

Main antenna : 2405 MHz

1.1 Horizontal

◆ XY-plane

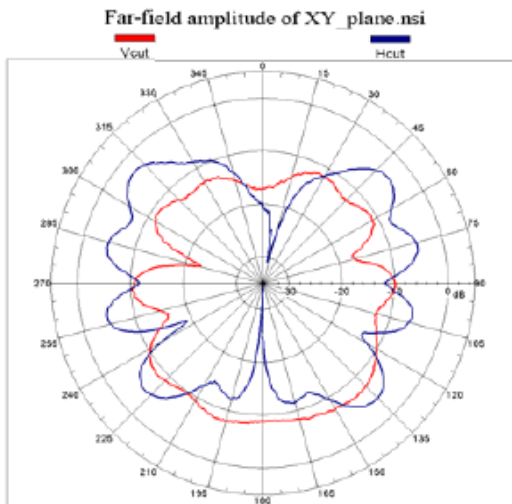

Unit : dBi

	Peak gain	Avg. gain
H cut	-3.04	-8.82
V cut	-7.19	-11.29
Total	-2.52	-6.53

1.2 Vertical

◆ XZ-plane

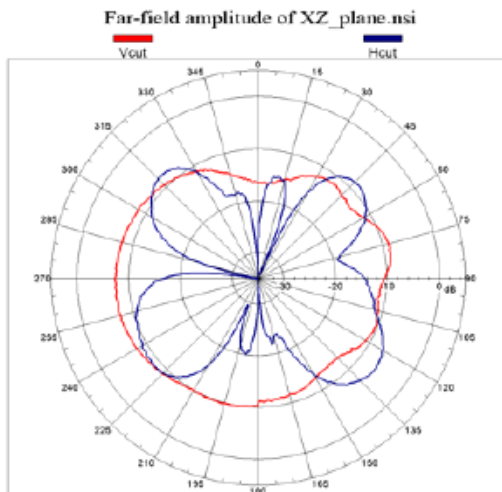

	Peak gain	Avg. gain
H cut	-6.44	-13.24
V cut	-7.34	-10.57
Total	-5.38	-8.35

1.

Main antenna : 2441 MHz

2.1 Horizontal

◆ XY-plane

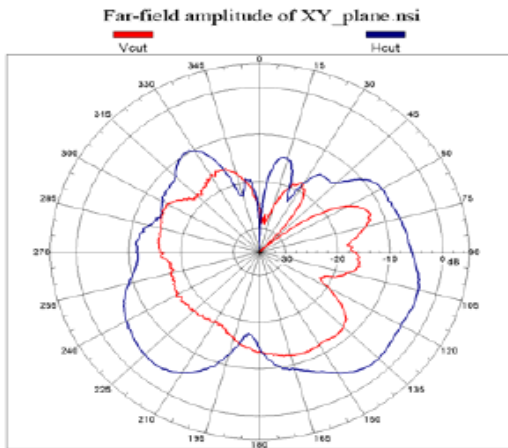

Unit : dBi

	Peak gain	Avg. gain
H cut	-2.89	-8.89
V cut	-11.81	-16.63
Total	-2.39	-8.05

2.2

Vertica

◆ XZ-plane

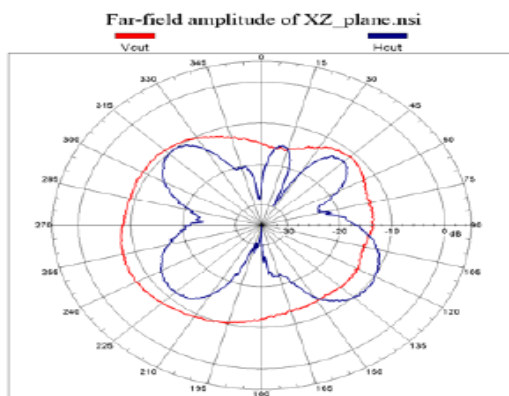

	Peak gain	Avg. gain
H cut	-9.56	-15.85
V cut	-7.29	-11.21
Total	-6.27	-9.66

3. Main antenna : 2475 MHz

3.1 Horizontal

◆ YZ-plane

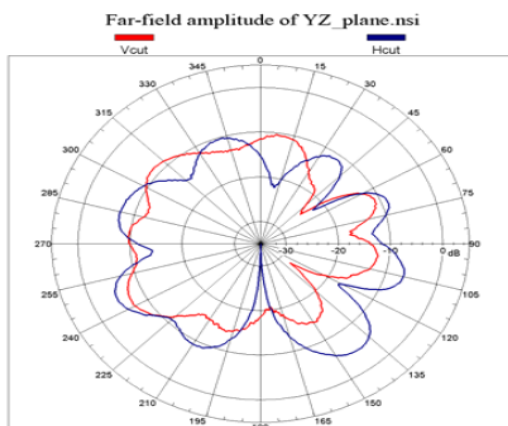

	Peak gain	Avg. gain
H cut	-4.74	-10.75
V cut	-7.09	-13.11
Total	-2.95	-8.49

3.2 Vertical

◆YZ-plane

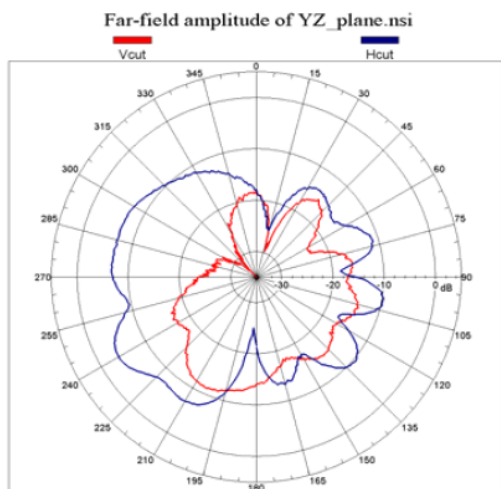

	Peak gain	Avg. gain
H cut	-3.99	-11.25
V cut	-11.31	-18.08
Total	-3.79	-10.11

4. Result

Center Frequency	Maximum Ant Gain	
2405MHz	H	-3.04 dBi
	V	-6.44 dBi
2441MHz	H	-2.39dBi
	V	-6.27 dBi
2475 MHz	H	-2.95 dBi
	V	-3.79dBi