

Version 1.0

Instruction Manual

ORION

X7

Original Instructions

Read the operator's manual carefully and make sure that you understand the instructions before you use the product.



SUNSEEKER®

Table of Contents

- 1. Platform X Overview** **1**
 - 1.1 Introduction 1
 - 1.2 Box Contents 1
 - 1.3 Parts and Functions 2
 - 1.4 Symbols and Decals 2
 - 1.5 Sunseeker All-Scenario Positioning 4
 - 1.6 Specifications 5

- 2.Safety Instructions** **6**
 - 2.1 General Safety Instructions 6
 - 2.2 Safety Instructions for Installation 7
 - 2.3 Safety Instructions for Daily Operation 7
 - 2.4 Safety Instructions for Maintenance 8
 - 2.5 Battery Safety 8

- 3.Installation** **8**
 - 3.1 Preparations 8
 - 3.2 Install the Charging Station 9
 - 3.3 Install the RTK Base Station 10
 - 3.4 Charge and Activate the Mower 12
 - 3.5 App Connection 12
 - 3.6 Robotic Mower app 15
 - 3.7 Set up Work Zone 16
 - 3.8 App Settings 21
 - 3.9 Notifications 21

- 4. Daily Operation** **22**
 - 4.1 Display and Control on the Mower 22
 - 4.2 IoT 23
 - 4.3 Obstacle Avoidance 23

- 5. Maintenance** **24**
 - 5.1 Cleaning 24
 - 5.2 Replace Blades 25
 - 5.3 Transportation 26
 - 5.4 Battery 26
 - 5.5 Power Supply 27
 - 5.6 Storage 27
 - 5.7 Recycling and End-of-life Disposal 28

- 6.FAQ & Troubleshooting** **28**
 - 6.1 FAQ 28
 - 6.2 Data Privacy 29
 - 6.3 Troubleshooting 30

- 7. Important Information** **30**
 - 7.1 Limited Warranty 30
 - 7.2 Disclaimers 30
 - 7.3 Contact Information 31

1. Platform X Overview

1.1 Introduction

Platform X Robotic Mower

The Sunseeker Platform X system contains a robotic lawn mower, a charging station and a RTK base station. The robotic lawn mower and the RTK base station can receive satellite signals for positioning. The mower employs advanced centimeter-level RTK, VSLAM and Sunseeker AIR (Artificial Intelligence Recognition) to create accurate real-time environmental maps, offering precise device location.

Robotic Mower APP

Sunseeker Robotic Mower app is used for settings and daily operation of the Sunseeker robotic lawn mowers.

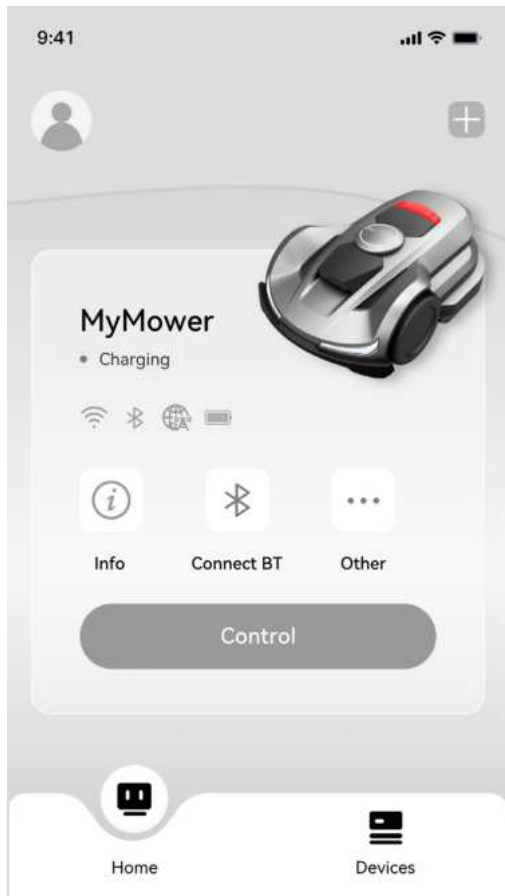

1.2 Box Contents

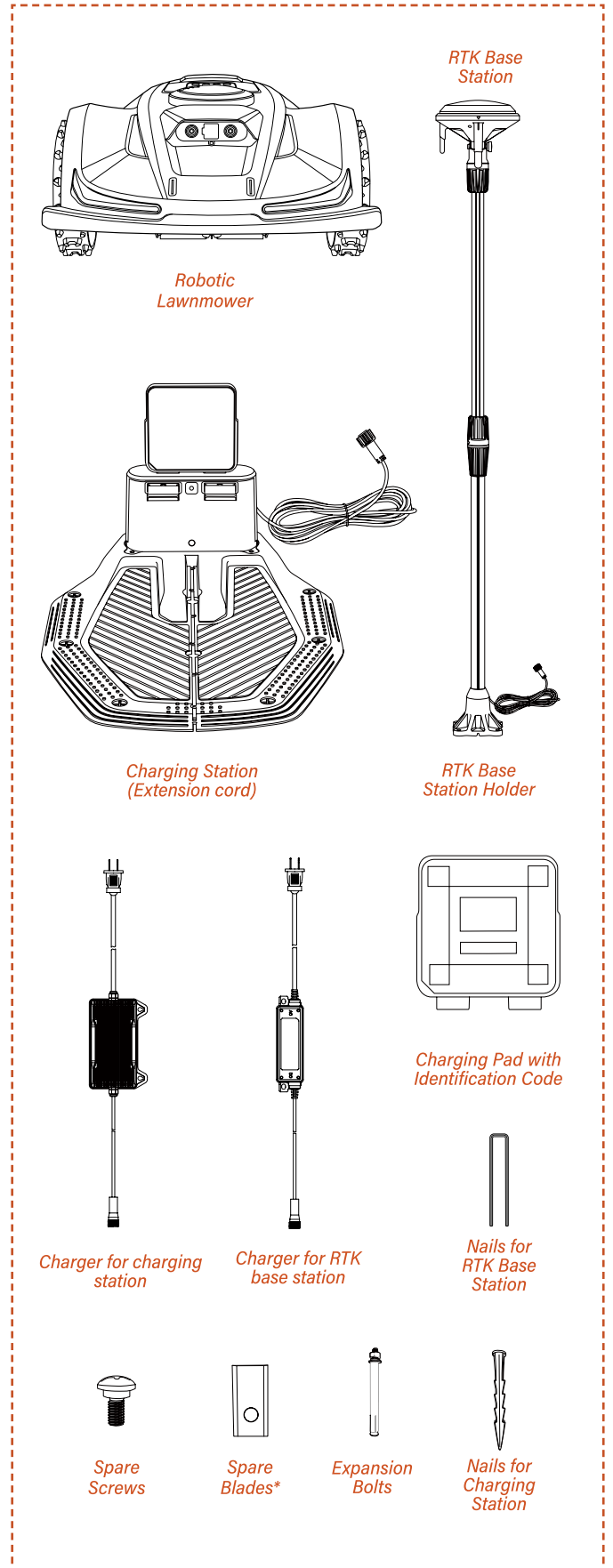

* X7-3000: 12 pcs, X7-6000: 18 pcs, X7-12000: 24 pcs

1.3 Parts and Functions

Top view

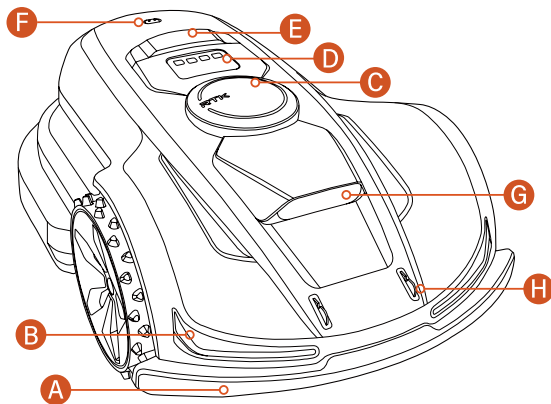

Bottom View

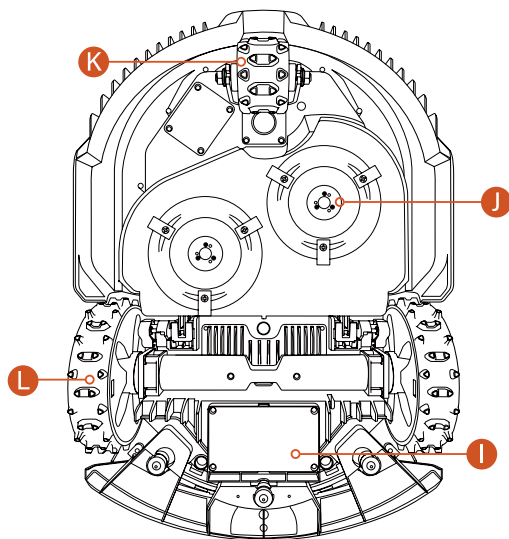

NOTE: Do not immerse the machine in water, as this may damage the components and void the warranty within the specified period.

A - Collision Bumper - When visual positioning is not available, the collision bumper can ensure the machine's normal operation.

B - LED Lights - Different interacting LED lights on the mower will indicate the machine's operating status.

C - RTK Positioning Antenna - Interactive positioning device for the RTK base station, the machine and satellites.

D - Control Panel - The panel to turn the machine's power on and off; to command the machine to work or return; and etc.

E - STOP Button - Emergency stop button to stop the machine in case of any urgent situation.

F - Rain Sensor - The rain sensor can detect rain and the machine can return to the charging station automatically to avoid rain according to the user's setting.

G - Binocular Camera - The AI-assisted binocular camera helps the mower to detect and avoid obstacles.

H - Charging Electrodes - The charging electrodes on the machine connect to the charging station electrodes to charge the machine's battery.

I - Battery Compartment - The storage for the battery.

J - Rotating Cutting Plate - Device for trimming the lawn when the machine is in operation.







K - Wheel Hub Motor - An excellent steering control device and power supply for operation.

L - Drive Wheels - Power output for movement with excellent off-road capabilities.





1.4 Symbols and Decals

These symbols can be found on the product. Please read them carefully.



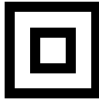

	<p>WARNING: Read the user instructions before operating the product.</p>
	<p>WARNING: Disable the product before working on or lifting the machine. Never touch the rotating blade</p>
	<p>WARNING: Keep a safe distance from the machine when operating. Keep other persons out of the danger area.</p>
	<p>WARNING: Do not ride on the machine.</p>

	<i>Read the user instructions.</i>
	<i>ETL conformity mark.</i>
	<i>Sound power level, determined by European outdoor noise directive. The product's emissions are set out in Technical data on page 5 and on the rating plate.</i>
	<i>It is not permitted to dispose this product as normal household waste. Ensure that the product is recycled in accordance with local legal requirements.</i>
	<i>Class III</i>
	<i>DC</i>





Symbols on charger



	<i>Read the user instructions.</i>
T3.15A 	<i>Replace with fuse in accordance with rating</i>
T5A 	<i>Replace with fuse in accordance with rating</i>
	<i>Class II construction.</i>
	<i>Do not discarded as unsorted waste but must be sent to separate collection facilities for recovery and recycling in accordance with local legal requirements.</i>

Symbols on battery pack

	<i>Read the user instructions.</i>
	<i>Do not discard the battery into fire and do not expose the battery to a heat source.</i>
	<i>Do not immerse the battery into water.</i>
 Li-ion	<i>Recyclable mark.</i>
 Li-ion	<i>It is not permitted to dispose this battery pack as normal household waste. Ensure that the battery pack is recycled in accordance with local legal requirements.</i>

Symbols on robot screen

	<i>Power on/off</i>
	<i>Start button</i>
	<i>Home button</i>
	<i>Ok button</i>
	<i>PIN code setting</i>

	<i>Times setting</i>
	<i>Bluetooth</i>
	<i>Wi-Fi</i>

1.5 Sunseeker All-Scenario Positioning

RTK full-frequency satellite positioning technology assists the lawnmower in acquiring high-precision location information. Combined with VSLAM technology and Sunseeker AIR (Artificial Intelligence Recognition), the robot can perform positioning and navigation tasks in all scenarios, including complex environments, ensuring high-quality lawn maintenance at all times.

Sunseeker's combination of advanced hardware and software (intelligent algorithms) significantly improves the mower's environment recognition, positioning accuracy, and work performance. Mirroring a human brain, Sunseeker advanced algorithms can process information gathered from RTK (Real-Time Kinematic), VSLAM (Visual Simultaneous Localization and Mapping), IMU (Inertial Measurement Unit), and odometers, to optimize the method of environment recognition under all sorts of conditions.

Sunseeker RTK technology, by receiving full-frequency satellite signals and conducting real-time positioning, allows users to set virtual boundaries for their lawnmowers to work **without traditional boundary wires**. Within the virtual boundaries, the lawnmower can plan mowing paths with high-precision and efficiency, and therefore, reach ultimate mowing coverage.

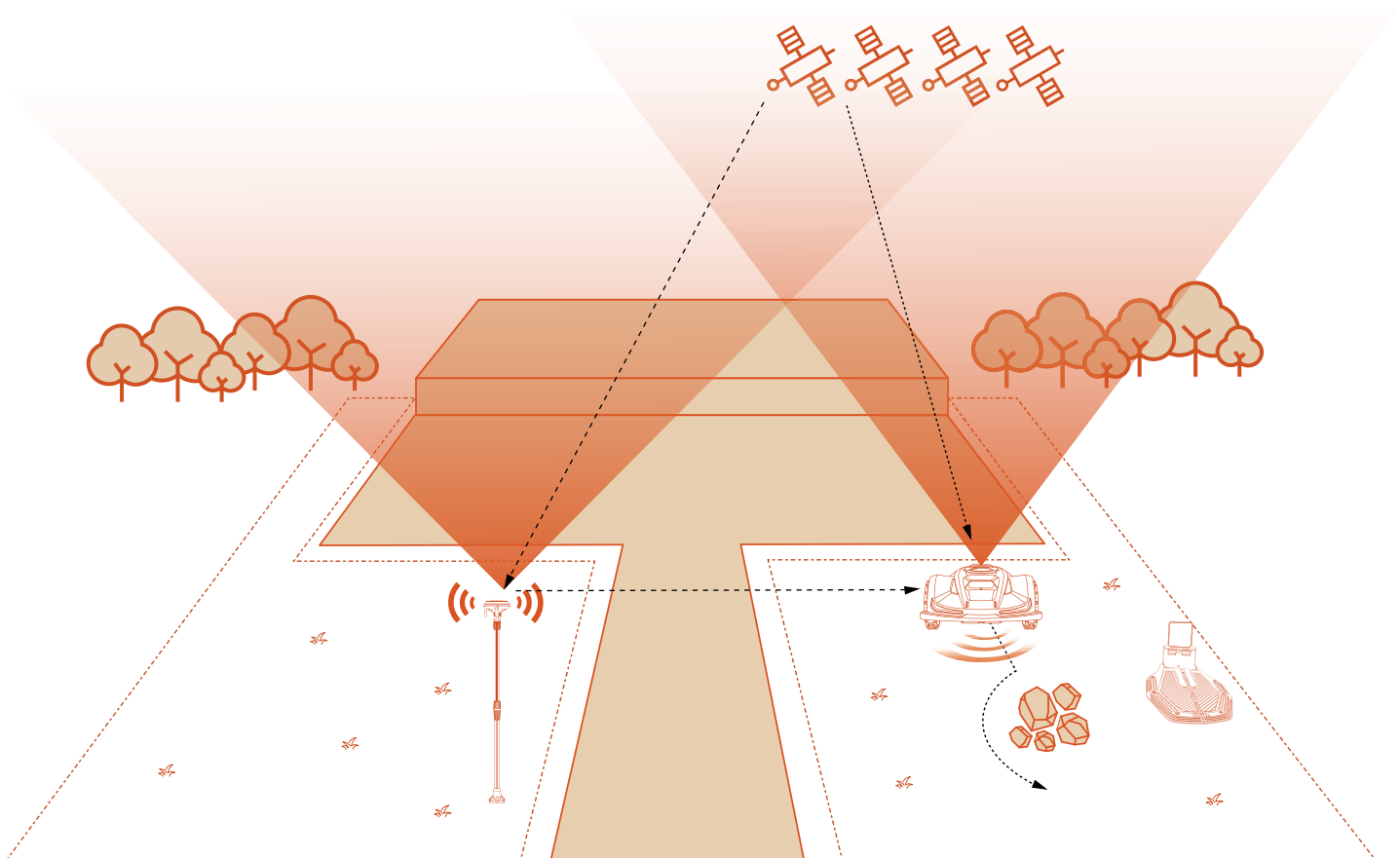

1.6 Specifications

TECHNICAL SPECIFICATION	X7-3000 RMX3000K20VU	X7-6000 RMX6000K20VU	X7-12000 RMX12000K20VU
Boundary wire	Wireless / boundary free	Wireless / boundary free	Wireless / boundary free
Max mowing area	0.75 acre	1.5 acre	3 acre
Cutting height min/max	0.8-4.0 in.	0.8-4.0 in.	0.8-4.0 in.
Height adjustment	Via APP	Via APP	Via APP
Cutting width	14.0 in.	14.0 in.	14.0 in.
Battery Capacity	5 Ah	10 Ah	10 Ah
User interface	APP & keypad display	APP & keypad display	APP & keypad display
Max slope	28° (53%)	35° (70%)	35° (70%)
Robot dimensions	29.2*20.2*10.2 in	29.2*20.2*10.2 in	29.2*20.2*10.2 in
Certificates	ETL, FCC, DOE	ETL, FCC, DOE	ETL, FCC, DOE
Net weight	30.5 lbs	31 lbs	31 lbs
Sound power level	68 dB (A)	68 dB (A)	68 dB (A)
FEATURES			
Wifi / Bluetooth	●	●	●
Intelligent mapping	●	●	●
Path planning	3 options	3 options	3 options
VSLAM	●	●	●
Super Wifi	●	●	●
FOTA	●	●	●
Quick return to charging station	●	●	●
AWD (all wheel driven) wheels	3 wheels	3 wheels	3 wheels
Garden Map on APP	●	●	●
Multi-zones	Up to 10	Up to 15	Up to 20
Working schedule (setted in APP)	Automatic or manual setting via APP	Automatic or manual setting via APP	Automatic or manual setting via APP
Electronic Cutting Height Adjustment	●	●	●
Bump sensor	●	●	●
Water wash	●	●	●
Anti-theft: by GPS + 4G*	○	●	●
Google assistant & Amazon Alexa	●	●	●
PIN code	●	●	●
Lift & Tilt sensor	●	●	●
Rain sensor	●	●	●
Eco mode	●	●	●
Night mode	-	●	●
LED head lights	●	●	●
ACCESSORIES			
Base fitting nails	8pcs	8pcs	8pcs
Charger	3A (CGF253)	5A (CGF255)	7A (CGF257)
Power supply charger	1A (CGF251)	1A (CGF251)	1A (CGF251)

YES:● NO: - OPTIONAL:○

2. Safety and Regulations

2.1 General Safety Instructions

WARNING Read all safety warnings, instructions, illustrations and specifications provided with this product. Failure to follow all instructions listed below may result in electric shock, fire and/or serious injury.

This product is not intended for use by children or persons with reduced physical, sensory or mental capabilities (that could affect a safe handling of the product), or lack of experience and knowledge, unless they have been given supervision or instruction concerning the use of the product by a person responsible for their safety.



WARNING:

- Automatic lawn mower! Keep away from the machine! Supervise children!
- Save all warnings and instructions for future reference.

1) Work area safety

a) Do not operate machines in explosive atmospheres, such as in the presence of flammable liquids, gases or dust. *Machines create sparks which may ignite the dust or fumes.*

b) Read the instructions carefully. Be familiar with the controls and the proper use of the machine.

c) Never allow people unfamiliar with these instructions or children to use the machine.

Local regulations may restrict the age of the operator.

d) The operator or user is responsible for accidents or hazards occurring to other people or their property.

2) Electrical safety

a) Mains plugs must match the outlet. Never modify the plug in any way. Do not use any charger plugs with earthed (grounded) devices. *Unmodified plugs and matching outlets will reduce risk of electric shock.*

b) Avoid body contact with earthed or grounded surfaces, such as pipes, radiators, ranges and refrigerators. *There is an increased risk of electric shock if your body is earthed or grounded.*

c) Do not abuse power cords. Never use the power cord for carrying, pulling or unplugging a device. Keep power cords away from heat, oil, sharp edges or moving parts. *Damaged or entangled power cords increase the risk of electric shock.*

d) If operating a mains-powered device in a damp location is unavoidable, use a residual current device (RCD) protected supply. *Use of an RCD reduces the risk of electric shock.*

e) Ensure the correct installation of the automatic perimeter delineation system as instructed.

f) Periodically inspect the area where the machine is to be used and remove all stones, sticks, wires, bones, and other foreign objects.

g) Periodically visually inspect to see that the blades, blade bolts and cutter assembly are not worn or damaged. *Replace worn or damaged blades and bolts in sets to preserve balance.*

h) On multi-spindle machines, take care as rotating one blade can cause other blades to rotate.

3) Personal safety

a) Do not allow persons unfamiliar with the machine or these instructions to operate the machine.

Machines are dangerous in the hands of untrained users.

b) Stay alert, watch what you are doing and use common sense when operating a device. Do not use a device while you are tired or under the influence of drugs, alcohol or medication. *A moment of inattention while operating devices may result in 1094 serious personal injury.*

c) Remove any adjusting key or wrench before operating the machine. *A wrench or a key left attached to a rotating part of the machine may result in personal injury.*

d) When controlling the machine manually, keep proper footing and balance at all times. *This enables better control of the machine in unexpected situations.*

e) Do not let familiarity gained from frequent use of machines allow you to become complacent and ignore machine safety principles. *A careless action can cause 1101 severe injury within a fraction of a second.*

4) Machine use and care

a) Disconnect the plug from the power source and/or remove the battery pack, if detachable, from the machine or other devices before making any adjustments, changing accessories, or storing. *Such preventive safety measures reduce the risk of unintended starting.*

b) Maintain machines and accessories. Check for misalignment or binding of moving parts, breakage of parts and any other condition that may affect the machine's operation. If damaged, have the machine repaired before use. *Many accidents are caused by poorly maintained machines and accessories.*

c) Use the machine and accessories in accordance with these instructions, taking into account the working conditions and the work to be performed. *Use of the machine for operations different from those intended could result in a hazardous situation.*

d) Never operate the machine with defective guards, or without safety devices. *For example deflectors and/or grass catchers, in place.*

e) Do not put hands or feet near or under rotating parts. *Keep clear of the discharge opening at all times.*

f) Never pick up or carry an machine while the motor is running.

- g) Activate device lock/Set into "LOCK" to the machine
- before clearing a blockage;
- before checking, cleaning or working on the machine.

h) Do not leave the machine to operate unattended if you know that there are pets, children or people in the vicinity.

5) Service

a) Have your machine serviced by a qualified repair person using only identical replacement parts. This will ensure that the safety of the machine is maintained.

b) Keep all nuts, bolts, and screws tight to be sure the machine is in safe working condition.

c) Check the grass catcher frequently for wear or deterioration.

e) Replace worn or damaged parts for safety.

e) Ensure that only replacement cutting means of the right type are used.

f) Ensure that batteries are charged using the correct charger recommended by the manufacturer. Incorrect use may result in electric shock, overheating or leakage of corrosive liquid from the battery.

g) In the event of leakage of electrolyte flush with water/neutralizing agent, seek medical help if it comes into contact with the eyes, etc.

h) Servicing of the machine should be according to manufacturers' instructions.

6) BATTERY tool use and care

a) Recharge only with the charger specified by the manufacturer. A charger that is suitable for one type of BATTERY pack may create a risk of fire when used with another BATTERY pack.

b) Use power tools only with specifically designated BATTERY packs. Use of any other BATTERY packs may create a risk of injury and fire.

c) When BATTERY pack is not in use, keep it away from other metal objects, like paper clips, coins, keys, nails, screws or other small metal objects, that can make a connection from one terminal to another. Shorting the BATTERY terminals together may cause burns or a fire.

d) Under abusive conditions, liquid may be ejected from the BATTERY; avoid contact. If contact accidentally occurs, flush with water. If liquid contacts eyes, additionally seek medical help. Liquid ejected from the BATTERY may cause irritation or burns.

e) Do not use a BATTERY pack or tool that is damaged or modified. Damaged or modified batteries may exhibit unpredictable behaviour resulting in fire, EXPLOSION or risk of injury.

f) Do not expose a BATTERY pack or tool to fire or excessive temperature. Exposure to fire or temperature above 130 °C may cause explosion.

g) Follow all charging instructions and do not charge the BATTERY pack or tool outside the temperature range specified in the instructions. Charging improperly or at temperatures outside the specified range may damage the BATTERY and increase the risk of fire..

2.2 Safety Instructions for Installation

- 1) Do not install the charging station, including any accessory, at a location that is below, or within 24 in. from, any combustible material. In case of malfunction, heating of the charging station and the power supply may occur and create a potential risk of fire.
- 2) Do not put the power supply at a height where there is a risk it can be put in water. Do not put the power supply on the ground.
- 3) Do not encapsulate the power supply. Condensed water can harm the power supply and increase the risk of electrical shock.
- 4) Applicable to USA/Canada. If power supply is installed outdoors: Risk of Electric Shock. Install only to a covered Class A GFCI receptacle (RCD) that has an enclosure that is weatherproof with the attachment plug cap inserted or removed.
- 5) Do not install the charging station where there is a risk of standing water.

2.3 Safety Instructions for Daily Operation

- 1) Keep your hands and feet away from the rotating blades. Do not put your hands or feet near or below the product when it is set to ON.
- 2) Use the park mode or set the product to OFF when persons, especially children or animals are in the work area
- 3) Make sure that there are no objects such as stones, branches, tools or toys on the lawn. The blades can be damaged if it hits an object.
- 4) Do not lift the product or move it when it is set to ON.
- 5) Do not let the product collide with persons or animals. If a person or animal comes in the way of the product, stop the product immediately.
- 6) Do not put objects on top of the product, the charging station or the RTK reference station.
- 7) Do not use the product if the STOP button does not work.
- 8) Always set the product to OFF when it is not in operation.
- 9) Do not use the product at the same time as a pop-up sprinkler. Use the Schedule function so the product and pop-up sprinkler do not operate at the same time.
- 10) Do not let the product operate when there is standing water in the work area. For example, when heavy rain forms pools of water.

2.4 Safety Instruction for Maintenance

- 1) Set the product to OFF when you do maintenance on the product.
- 2) Do not use a high-pressure washer to clean the product. Do not use solvents to clean the product.
- 3) Disconnect the plug to the charging station before you clean or do maintenance of the charging station.

2.5 Battery Safety

Lithium-ion batteries can explode or cause fire if disassembled, short-circuited, exposed to water, fire, or high temperatures. Handle carefully, do not dismantle, open the battery or use any type of electrical/mechanical abuse. Avoid storage in direct sunlight.

3. Installation

3.1 Preparations

Prepare the app

For a successful setup, please scan the QR code to download the Robotic Mower app. Alternatively, you can go to the Google Play Store (Android) or the Apple App Store (iOS) and search for "Robotic Mower".

Once you have installed the app, you need to register and log in. Please make sure to complete the registration process before logging in.

NOTE: When necessary, the app will request access to Bluetooth and Wi-Fi networking. To ensure proper setup and future functionality, it is recommended to grant all access to these features.

Prepare the lawn

- A. Clear away any debris, piles of leaves, toys, wires, stones, or other obstacles.
- B. To ensure safety, please make sure that children and pets are off the lawn.
- C. Please cut your lawn to a height of no more than **4.0** in. before using the robotic mower.

Recommended lawn types:

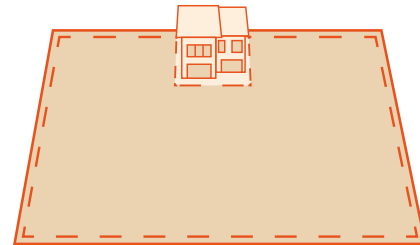
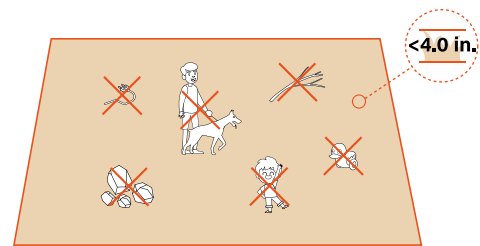

Total lawn size is between 0.05 acre to 3 acre.

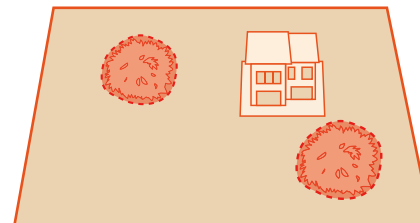

High covers such as tall walls or trees takes $< 30\%$ space on your lawn.

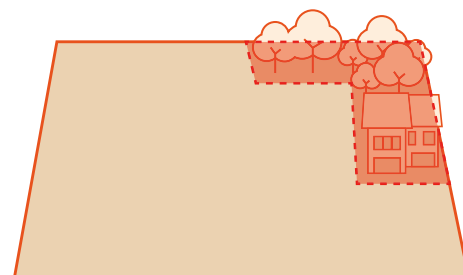

Lawn boundary cover with tall trees/walls takes $< 50\%$ space on your lawn.



Narrow lane with width < 9.84 ft and length > 16.4 ft, and with tall trees & wall on both sides, takes $< 30\%$ space on your lawn.

Not recommended lawn types:

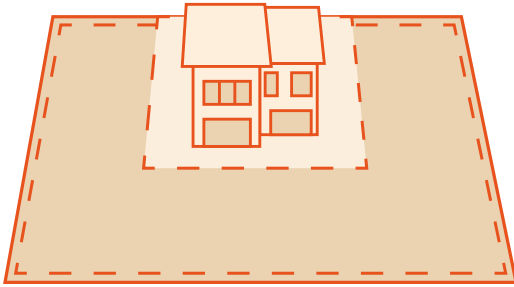

Total lawn size is smaller than 0.05 acre.

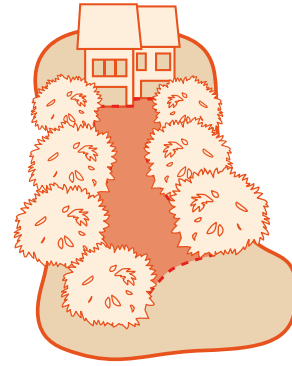

Narrow lane with width < 9.84 ft and length > 16.4 ft, and with tall trees & wall on both sides, takes $> 30\%$ space on your lawn.

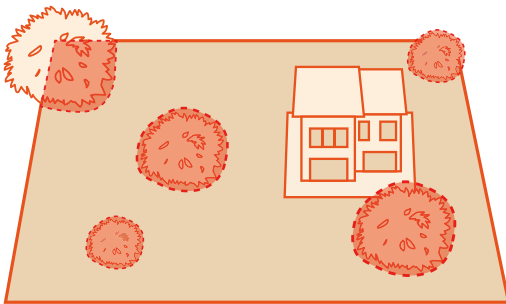

High covers such as tall walls or trees takes $> 30\%$ space on your lawn.

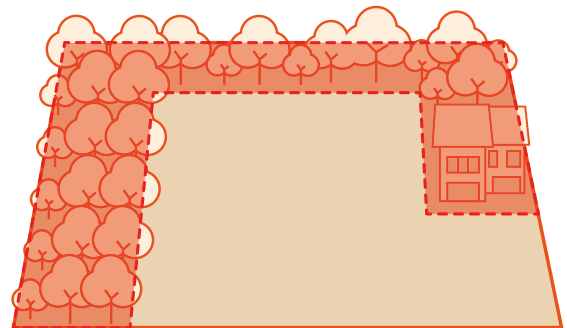

Lawn boundary cover with tall trees/walls takes $> 50\%$ space on your lawn.

3.2 Install the Charging Station

Step 1: Assemble the charging station:

Insert the charging pad with identification code on it into the card slot.

Step 2: Find a good location:

- A. Please install the charging station on an open area with a flat ground.
- B. There should be no obstacles within 60 in. in the front of the charging station. The 180° space at the front of the station needs to be as open as possible.
- C. The height of the grass in front of the charging station needs to be less than 4 in. to ensure that the mower can exit and return to the station successfully.
- D. The location should be covered with your household Wi-Fi.

Step 3: Install the charging station:

- A. Nail the charging station on a non-hardened and flat ground.
- B. Connect the power charger and wire to the power supply. If there is a certain distance from the charging station and the power supply, the charging wire needs to be properly fixed to the ground and wall to ensure a safe operation.

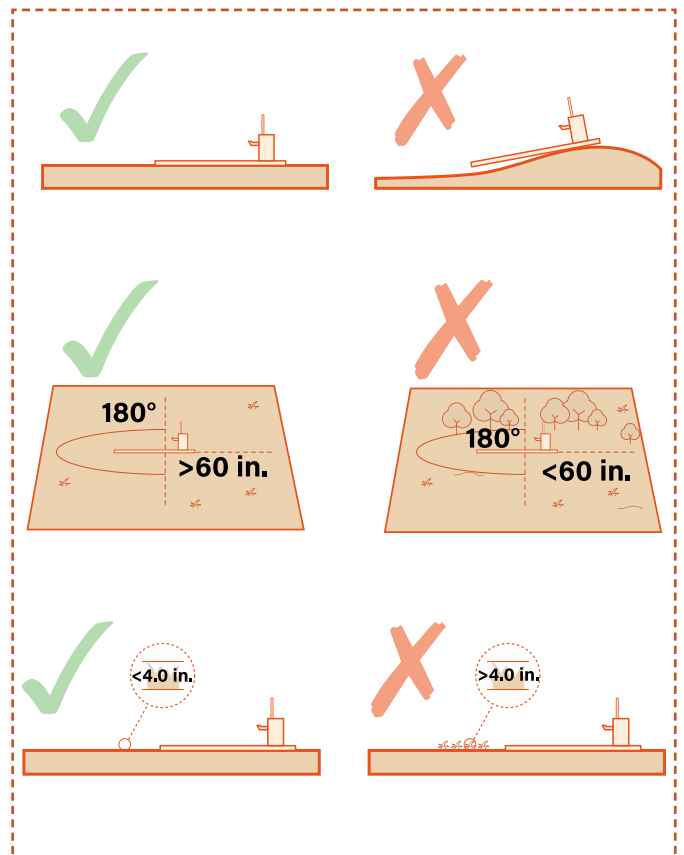

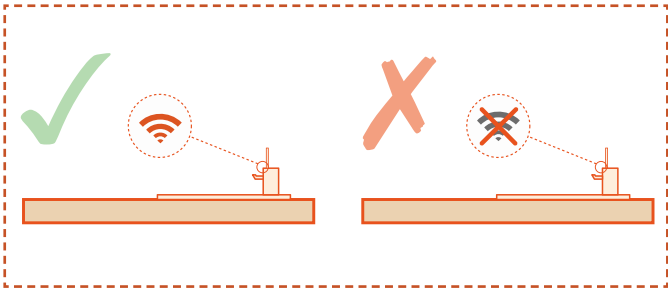

3.3 Install the RTK Base Station

Step 1: Find a good location:

A. The location should be covered with your household Wi-Fi.

B. Please place the RTK base station upright. Do not install the RTK base station on a slope.

C. In order to ensure a good reception of satellite signals, install the station in an open space with nothing blocking the signal, where it has a at least 100° clear signal-receiving angle with unobstructed sky. The distance between the RTK base station and the fences or walls must be greater than 20 in.

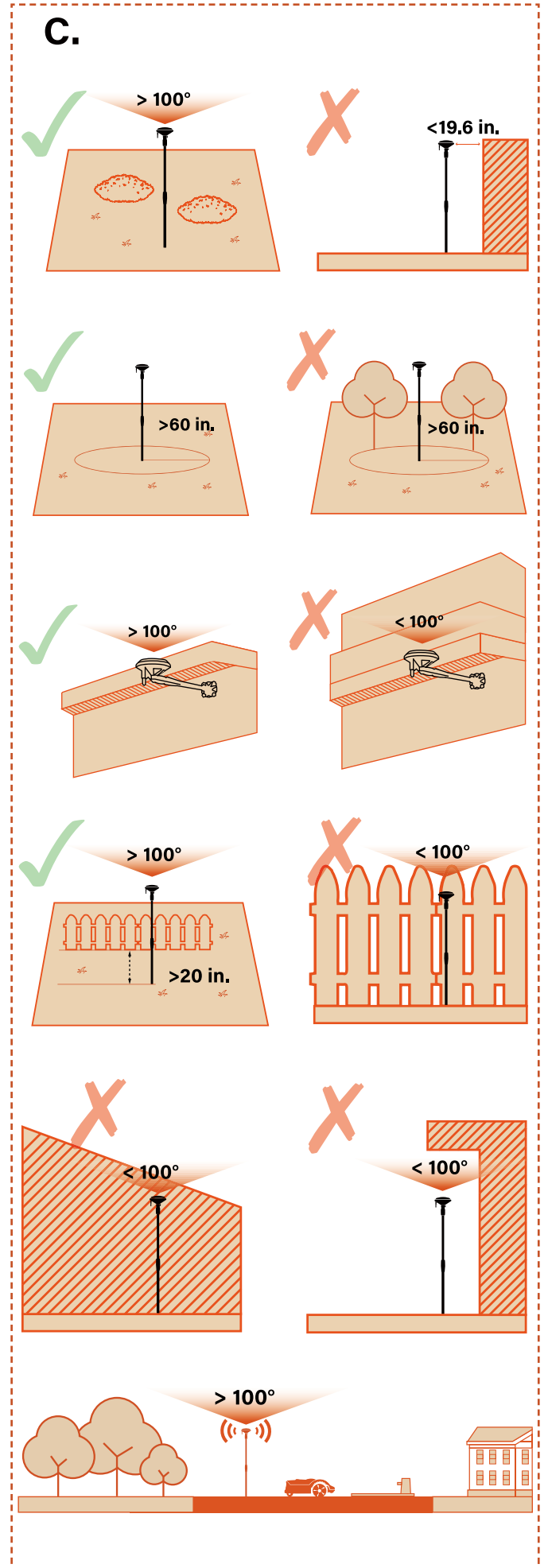
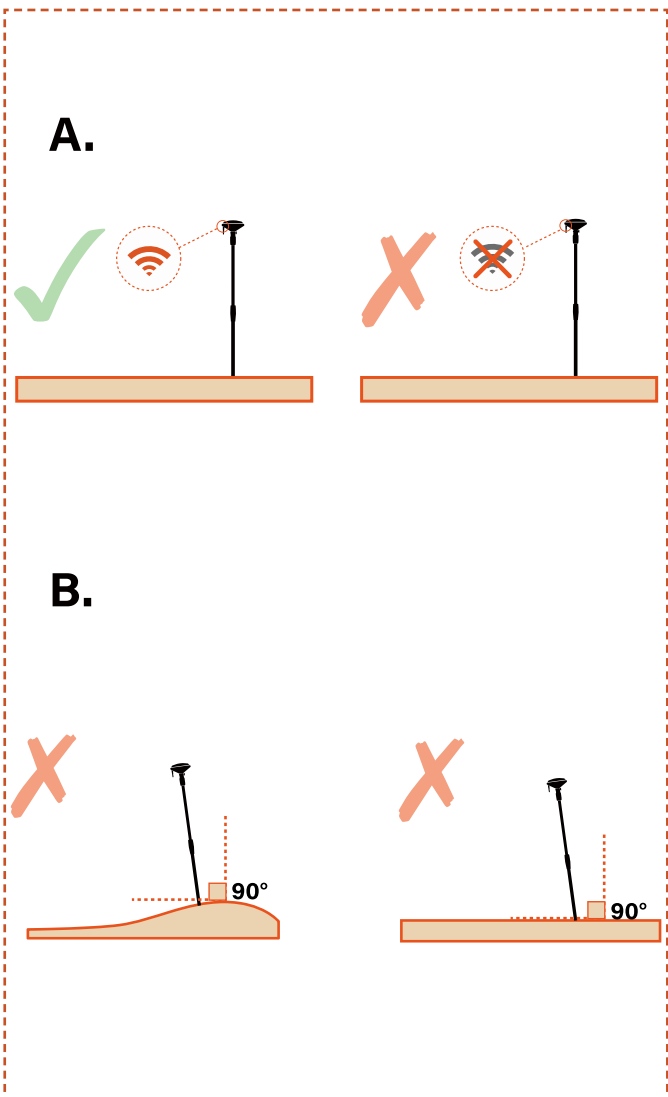

Step 2: Install the RTK base station:

- A. On a level and open ground (Installation Procedure);
- B. Under the eaves, on the roof or other high places with great signal reception (Installation Procedure).

Installation Procedure:

- A. Place the RTK base station in a location with an approachable power source.
- B. Connect the RTK base station's extension cable and charger.
- C. Plug the RTK base station into the power source.

Recommended location for the RTK base station based on the lawn shapes:

If you have separate lawns or your lawn shapes like the letter "O", "U", we recommend that you install the RTK base station on the roof or the wall.

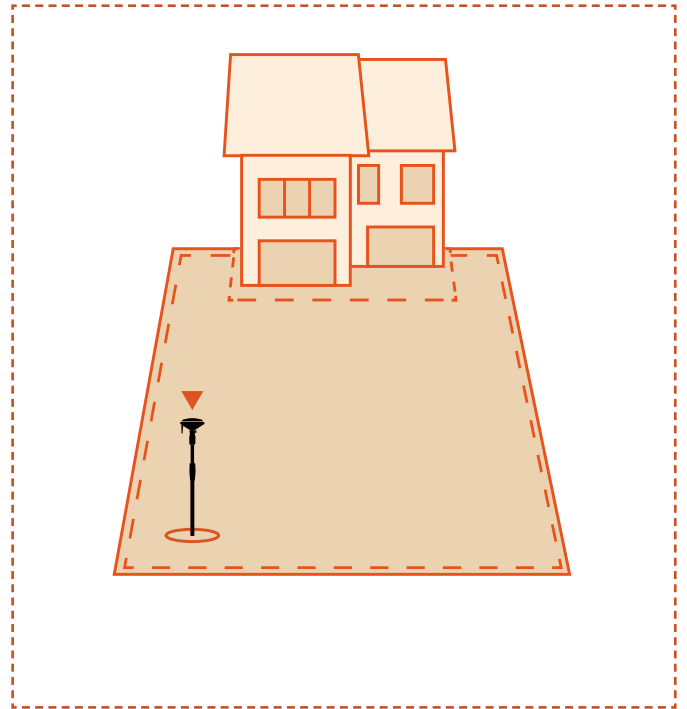
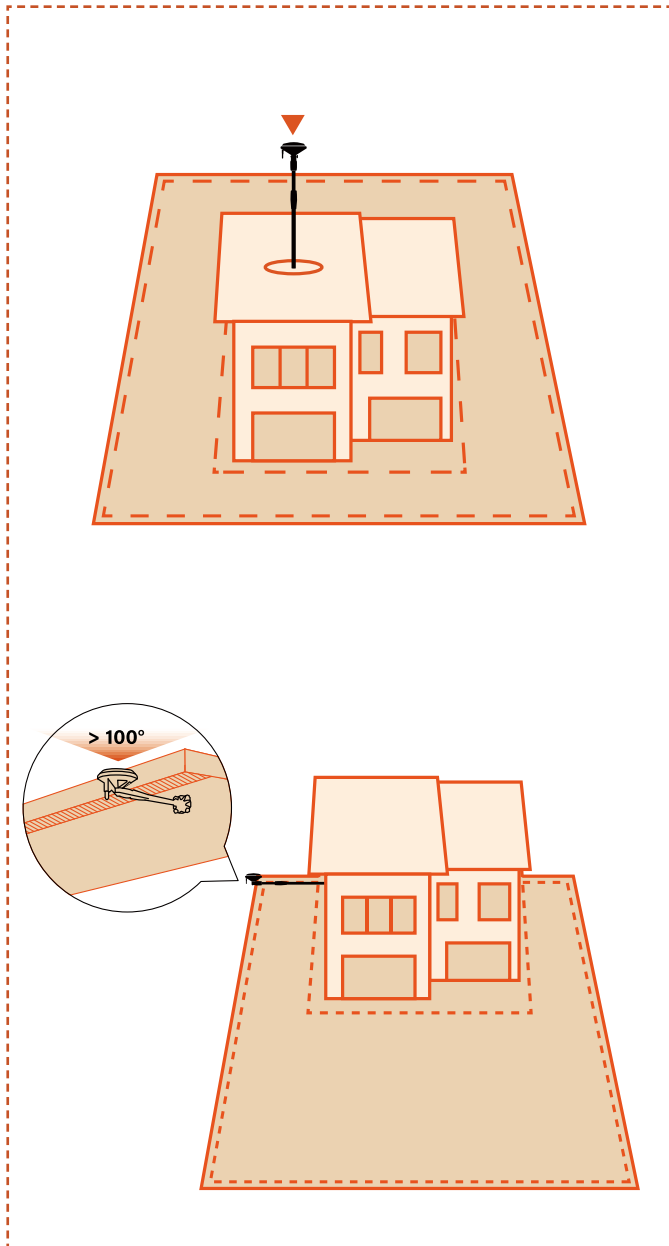

Step 3: Check the satellite signal:



From left to right:

📍 Location Indicator Light

- Solid green: Good satellite signal at this location.
- Solid orange: Weak satellite signal at this location; it is recommended to reinstall the base station in an area with better signal, free from obstructions.
- Solid red: Very weak satellite signal at this location; you must reinstall the base station in an area with a better signal, free from obstructions.

📶 Wi-Fi Indicator Light

- Solid green: Wi-Fi connected and server access established
- Blinking green: Wi-Fi connecting or not connected to the server
- No green light: Wi-Fi not connected

📶 Super Wi-Fi Indicator Light

- Solid green: Normal communication
- Blinking green: Pairing in progress
- No green light: Communication abnormality

🔌 Power Indicator Light

- Solid green: Power abnormality
- Blinking green: Power normal
- No green light: No power

3.4 Charge and Activate the Mower

Step 1 Charge the mower

Place the mower into the charging station with the charging electrodes connecting properly. The green light on the charging station flashing indicates normal charging.

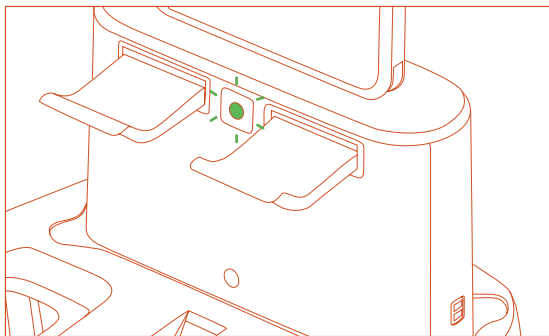

Enter the default password 0000 on the mower and press "OK" to complete the setting process. (see below)

Step 2 Activate the mower

A. Long press the Start and Home button to change the password.

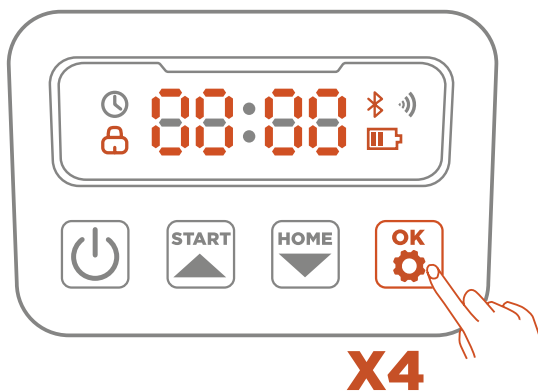

NOTE: If the indicator light remains off even when there is power supplied properly, please contact customer support.

Attention:

A. Chargers cannot be dropped on the ground within the virtual boundaries.

B. If the charging station is installed within the virtual boundaries, the extension cord of the charging station needs to be nailed to the ground to ensure the proper operation of the mower.



WARNING:

- DO NOT charge if the machine, the charger, the charging station, or the power socket are damaged.
- DO NOT charge the mower when the temperature is above 40°C (104°F), or below 5°C (41°F). When the temperature limit is exceeded, the battery will not charge.
- Immediately stop charging if an abnormal smell, sound, or light appears.
- Avoid charging near flammable or explosive materials.

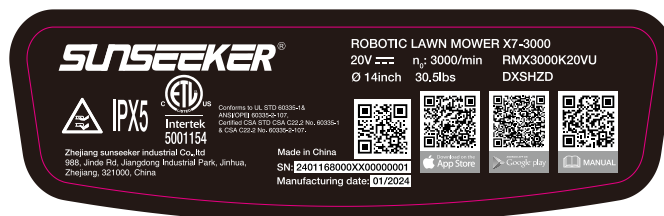

3.5 App Connection

> Ensure that the machine is on the charging station and being charged properly.

> Download the Robotic Mower app by scanning the QR code on the machine or from App Store/Google play.

Step 1: Create a new account and sign in. Turn on your phone's Bluetooth and Wi-Fi. Scan the machine's SN QR code to add your robotic lawn mower. After pairing successfully, enter the default machine password 0000. Passwords can be changed on the app anytime.