



SMD CERAMIC ANTENNA

Data Sheet

CA-2450-31

For 2400-2484MHz
3.2x1.6mm [EIA1206]

FEATURES

- Light weight,compact
- Wide bandwidth,lowcost
- Built-in antenna with high gain

APPLICATIONS

- Bluetooth
- IEEE802.11g/b
- Zigbee systems,etc...

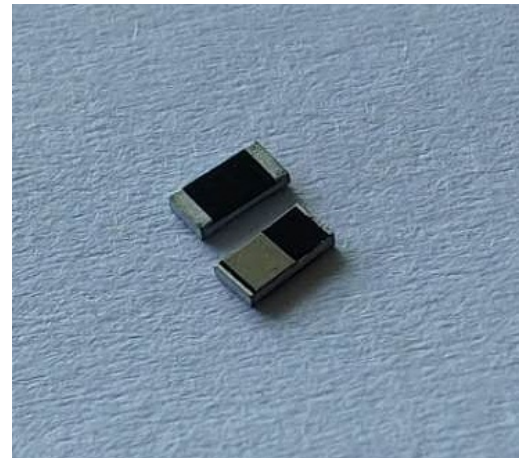

SHAPES AND DIMENSIONS Dimensions in mm

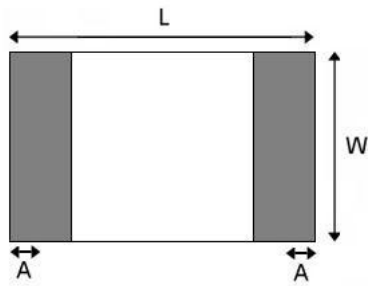

L	W	A	H
3.10±0.10	1.55±0.10	0.40±0.20	0.50±0.10



■ ELECTRIC SPECIFICATIONS

Product type	CA-2450-31
Center Frequency Range	2450MHZ
Input Impedance	50 Ω

■ PART NUMBERING SYSTEM

CA - **2450** - **31**
 Material Frequency Size

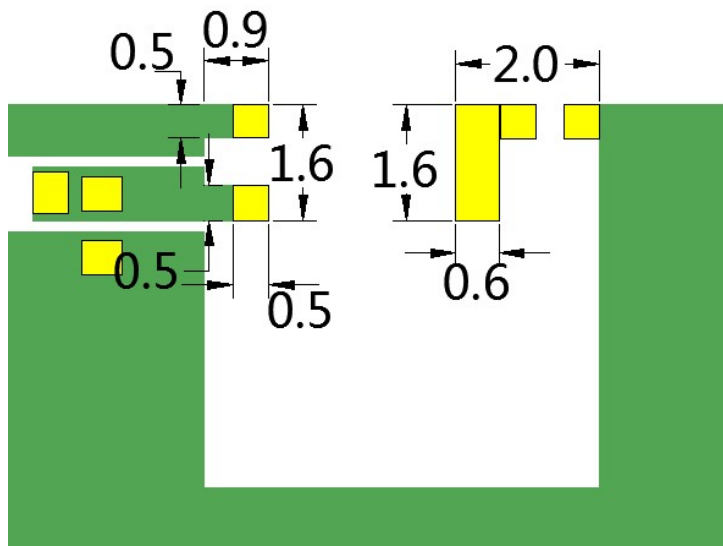

■ EVALUATION BOARD

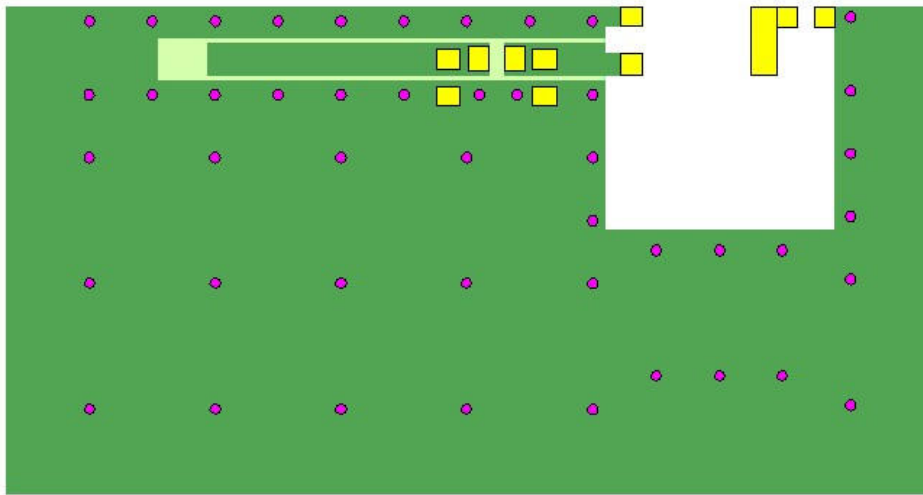

-  PAD
-  底层铺铜
-  顶层铺铜
-  打孔

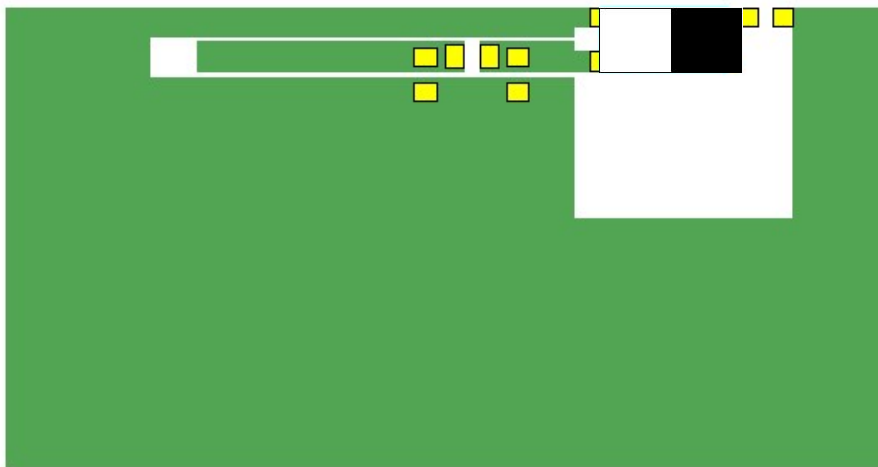

-  天线
-  PAD
-  底层铺铜
-  顶层铺铜

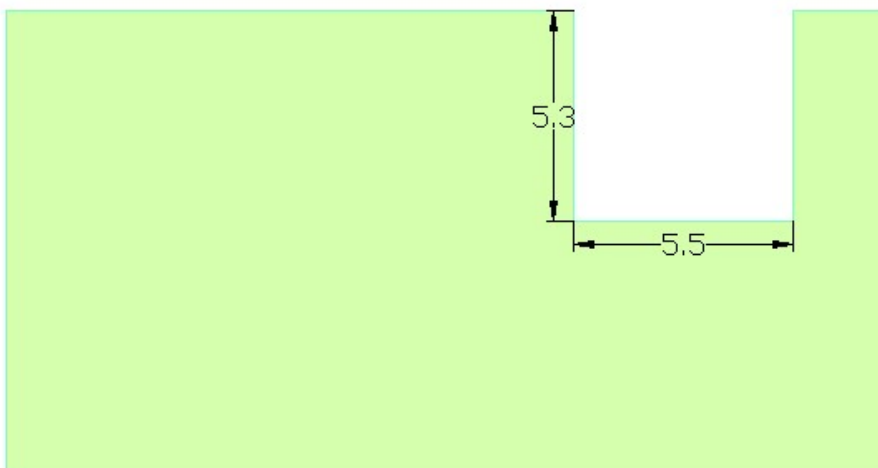

RADIATION PATTERNS

2.4GHz WLAN BAND

3D Gain Pattern (2400 MHz)

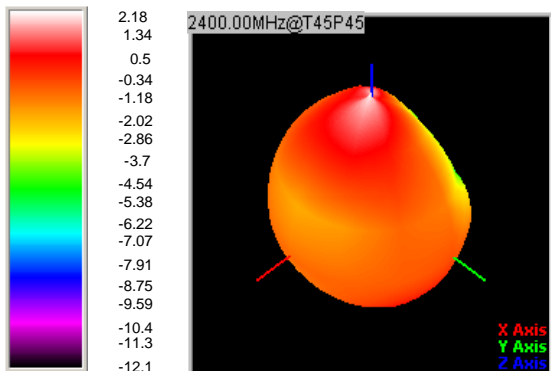

3D Gain Pattern (2440 MHz)

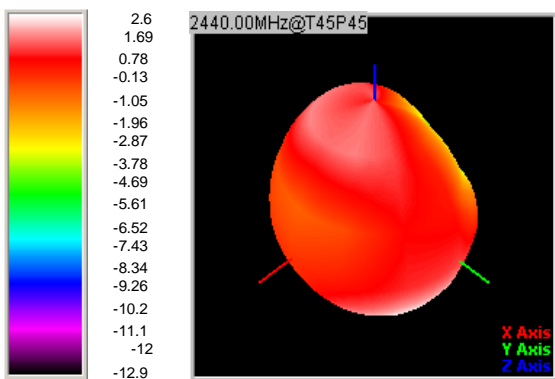

3D Gain Pattern (2480 MHz)

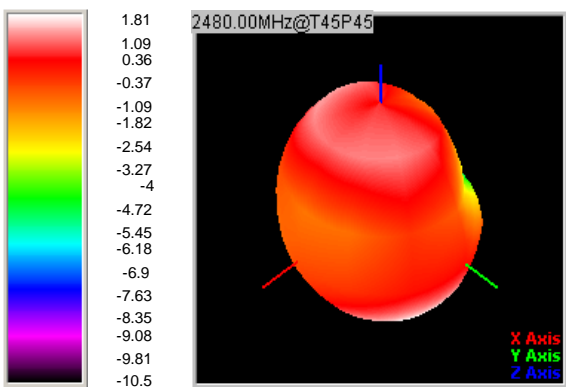

Freq (MHz)	Effi (%)	Gain (dBi)
2400	74.8	2.67
2410	72.59	2.54
2420	71.6	2.25
2430	70.29	2.07
2440	71.23	2.16
2450	72.3	2.37
2460	71.04	2.52
2470	65.95	2.35
2480	64.42	2.42
2490	62.59	2.31
2500	60.01	2.07

FREQUENCY CHARACTERISTICS

EFFICIENCY AND VSWR

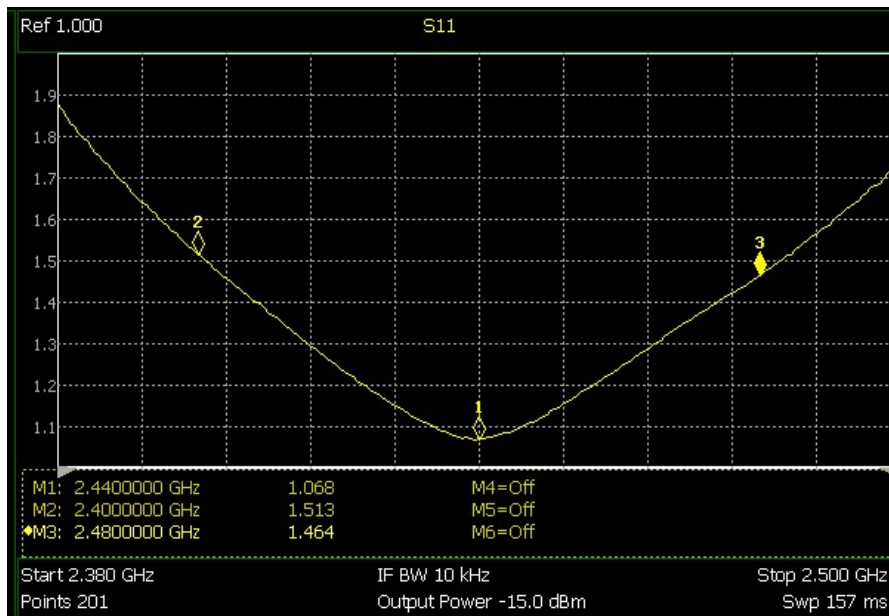
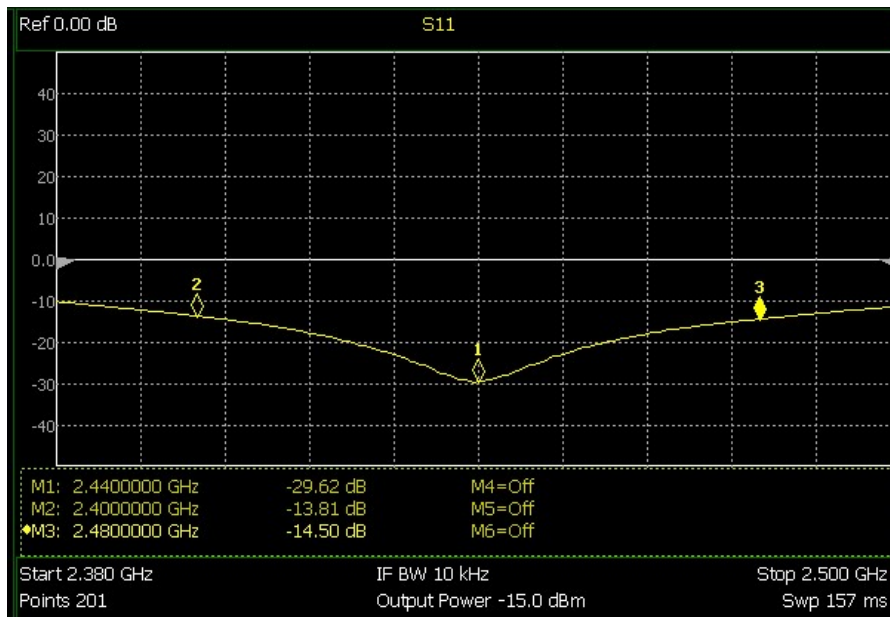

■ RECOMMENDED REFLOW PROFILE

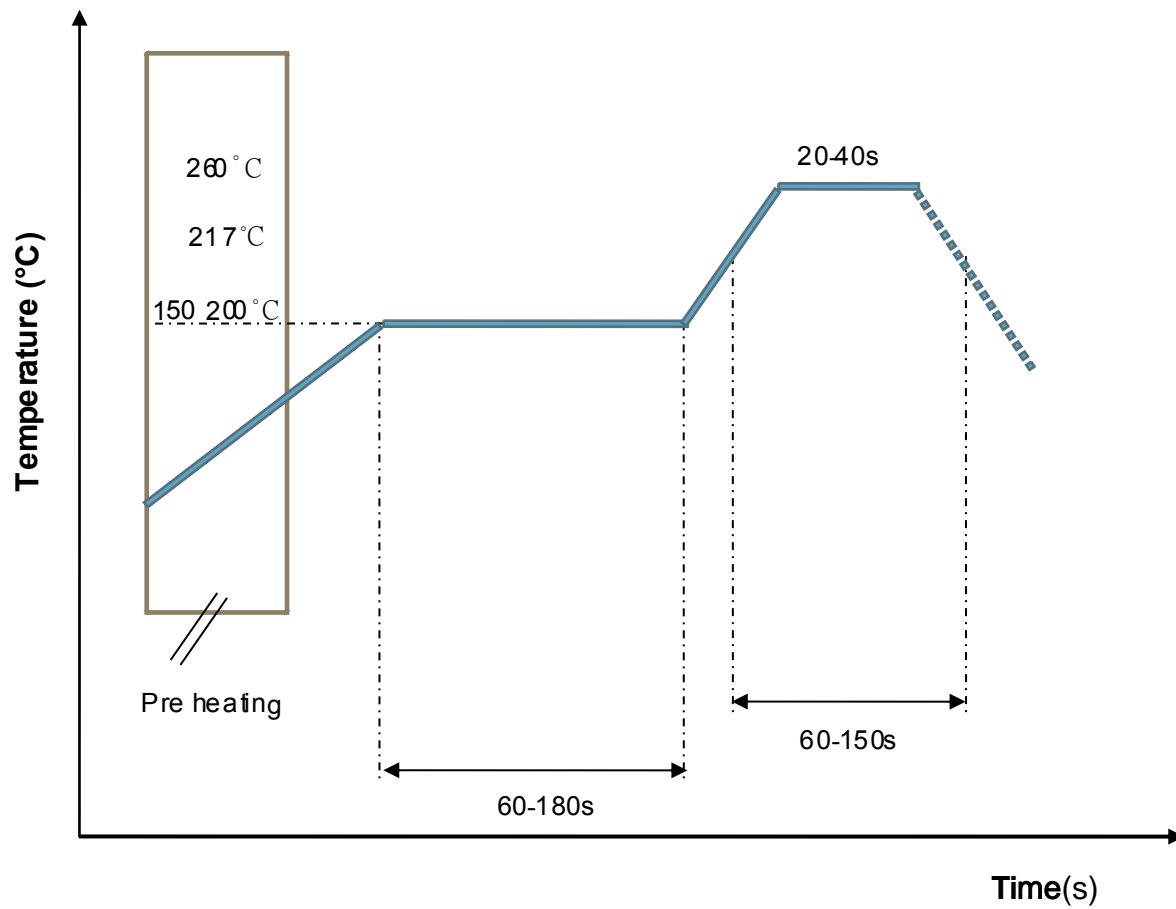

PACKAGING STYLE

REEL DIMENSIONS

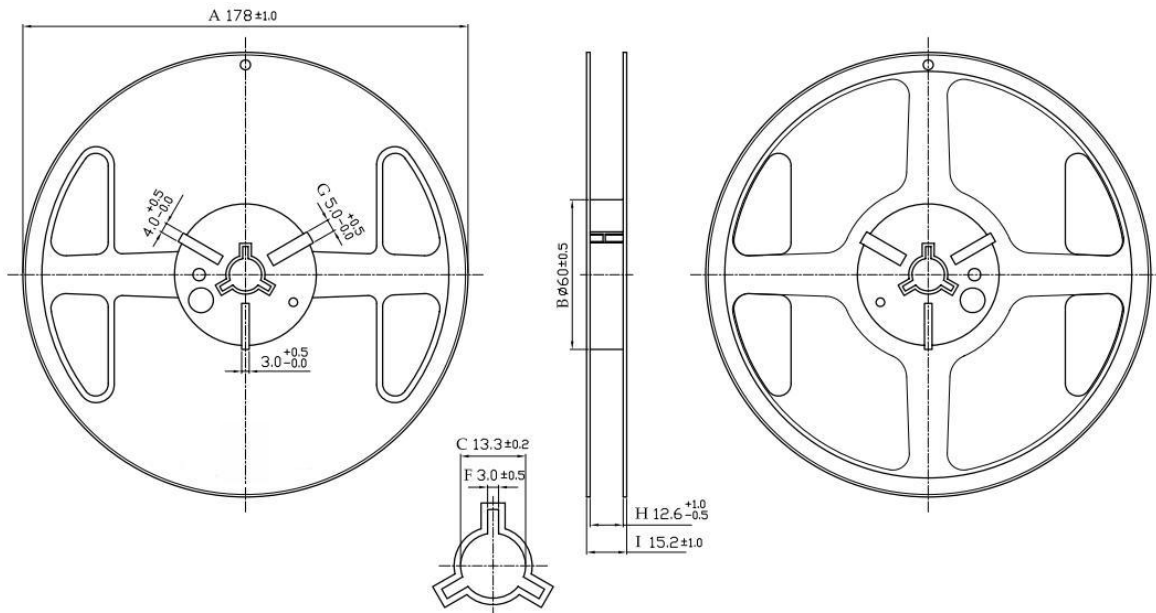

TAPE DIMENSIONS

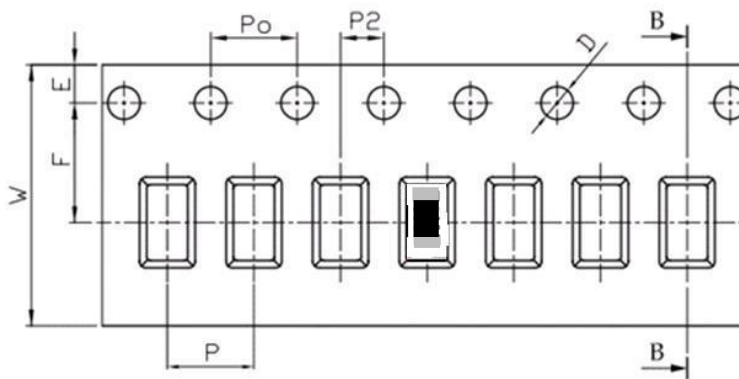

Feature	Specifications	Tolerances
W	8.00	± 0.30
P	4.00	± 0.10
E	1.75	± 0.10
F	3.50	± 0.10
P2	2.00	± 0.10
D	1.50	+0.10 -0.00
P ₀	4.00	± 0.10
10P ₀	40.00	± 0.20

Typing Quantity: 5000 pieces per 7" reel

Order Information

Device	Package	Net Weight	Carrier	Quantity	HSF Status
CA-2450-31	3216	0.0089g	Tape&Reel	5000pcs	RoHS compliant

Revision history

Date	Revision	Description of changes
2018-11-5	1.0	First Version
2022- 8-5	1.1	Update the package information

The contents of this data sheet are subject to change without notice.
Please confirm the specifications and delivery conditions when placing your order.

© Copyright 2015, Keweixin Electronics

All rights reserved