

# Jartoo

**Jartoo**  
www.jartoo.com

**Email**  
Support@Jartoo.com

## MANUFACTURER

Shenzhen Core Shadow Feiyang Technology Co.,Ltd.  
Room 702,Building 11,Phase II(02-08 Plot),Tianan Yungu Industrial Park,Gangtuo  
Community,Bantian Street,Longgang Distrct,Shenzhen.



MADE IN CHINA



## USER MANUAL

Model: JT-VBM002  
Jartoo Baby Monitor

## CONTENTS

1.SAFETY INSTRUCTIONS .....	00
2. CAUTION .....	00
3. PACKAGE CONTENTS .....	00
4.PRODUCT DIAGRAM .....	00
5.GETTING STARTED .....	00
6.FUNCTIONS & OPERATIONS.....	00
7.SPECIFICATIONS .....	00
8.TROUBLESHOOTING .....	00
9.WARRANTY & CUSTOMER SERVICE .....	00

# SAFETY INSTRUCTIONS

- Keep cord out of the reach of children (more than 3ft / 0.9m away) in case of STRANGULATION.

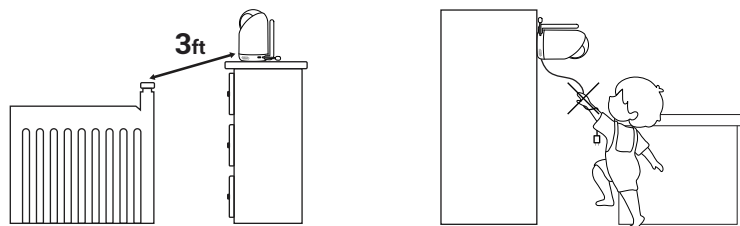

- NEVER place the camera or cord in or near the crib or playpen.
- NEVER mount the camera directly above the crib or playpen to avoid the risk of injury.
- Only use the AC adapters provided.
- Never use the unit near water, including near a bathtub, sink, laundry machine tube, wet basement, etc.
- Do not install near any heat sources such as radiators, heat registers, stoves, or other devices that produce heat.
- Only use attachments and accessories specified by the manufacturer.
- Unplug this device when unused for long periods of time.

# CAUTION

- NOT toys. Do not allow children to play with them.
- This product is NOT intended to replace the proper supervision of children. You MUST check your child's activity regularly.
- This product is not intended for use as a medical camera and its use should not replace adult supervision.
- Unplug the product during lightning storms.
- Please check the operating range and condition of the camera carefully at the initial installation, and on a regular basis after that.
- Check the reception regularly. Test the camera before use and after changing the camera's location.

- Clean the camera with a dry cloth only.
- Do not block any ventilation openings.
- Microphone feedback might occur when the monitor is too close to the camera. Please keep them at least 1.5m / 4.9ft apart.

# PACKAGE CONTENTS

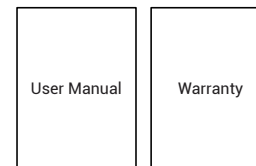
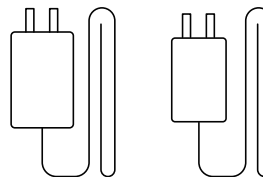
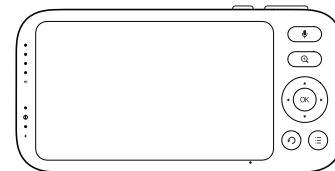
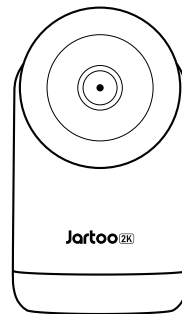

- Jartoo Baby Monitor & Camera (Model: JT-VBM002)
- Monitor Adapter (5V 2A )
- Camera Adapter (5V 1.2A)
- Micro USB Cable \*2
- User Manual
- Warranty

# PRODUCT DIAGRAM

## Camera

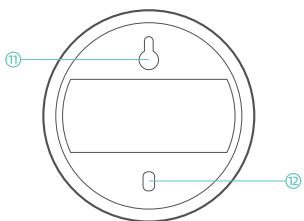
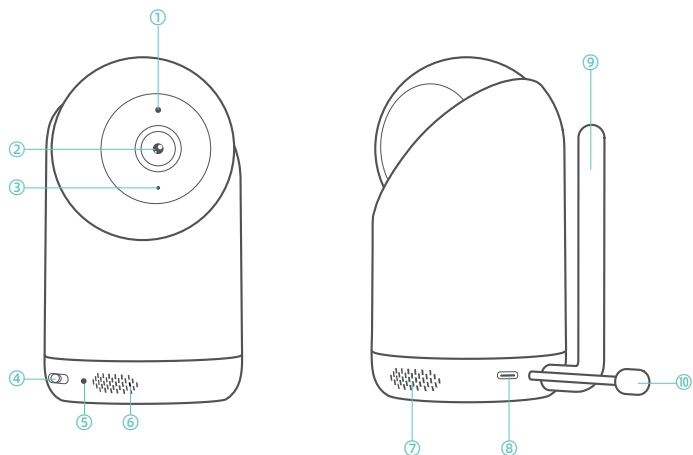

- ① Light sensor
- ② Lens
- ③ Microphone
- ④ Power Switch
- ⑤ Power indicator
- ⑥ Microphone
- ⑦ Speaker
- ⑧ USB-C
- ⑨ Camera Antenna
- ⑩ Temperature Sensor
- ⑪ Mounting Hole
- ⑫ Pairing Button

## Baby Monitor

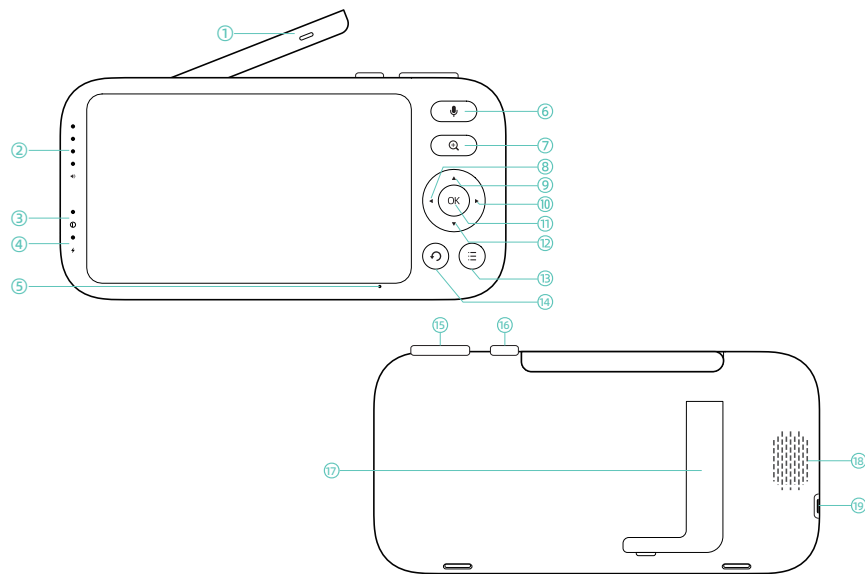

- ① Antenna
- ② Volume Indicators
- ③ Power Indicator
- ④ Charging Indicator
- ⑤ Microphone
- ⑥ Talk Button
- ⑦ Zoom Button
- ⑧ Left Button
- ⑨ Up Button
- ⑩ Right Button
- ⑪ OK Button
- ⑫ Down Button
- ⑬ Menu Button
- ⑭ Back Button
- ⑮ Volume Control
- ⑯ Power Button
- ⑰ Back Stand
- ⑱ Speaker
- ⑲ USB-C Port



Press and hold the Talk button to speak the camera.  
Press Power button to switch on/off the monitor screen. Press and hold the Power button 2 seconds to switch on/off the monitor.

# GETTING STARTED

## 1. Charging & Powering Baby Monitor

- 1) Connect the monitor adapter to the monitor and a power outlet.
- 2) Unplug the unit when its power indicator turns off, indicating a full charge.
- 3) Press and hold the Power button on the monitor to power on

## 2. Powering Camera

- 1) Connect the camera to power source via the TYPE-C cable and camera adapter.
- 2) Slide the Power Switch on camera to power on. Make sure the power indicator light is green.



- Only use the power adapters included in the package.
- Do not place the camera and power cord within the reach of your baby.

## 3. Pairing the Baby Monitor & the Camera

By default, one camera has been paired with the monitor when manufactured. When you power on the monitor and camera, the two will automatically pair.

To add more cameras, press the Pair Button at the the camera, press Menu button, select through -> Add-> , and then the monitor will auto-pair with the camera.



- Once they're paired successfully, the camera number with icon will be shown at the top left.
- Microphone feedback might occur when the monitor is too close to the camera. Please keep them at least 1.5m / 4.9ft apart.
- It is recommended to pair in the baby's room, or wherever you intend to place the camera.

## 4. Placing the Camera

Place the camera 2m / 6.6ft away from your baby for safety reason and for a better view when in night vision mode.

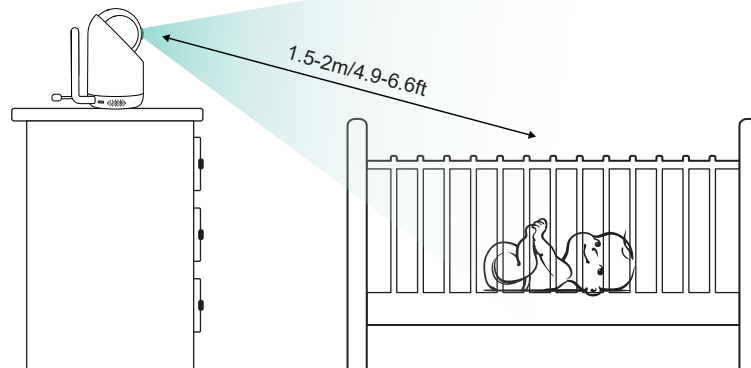

## 5. Wall Mounting Camera

- 1) Select the spot to mount the camera, keeping it beyond your baby's reach.
- 2) Insert the screw (not included) pre-installed on wall into the mounting hole of the camera.

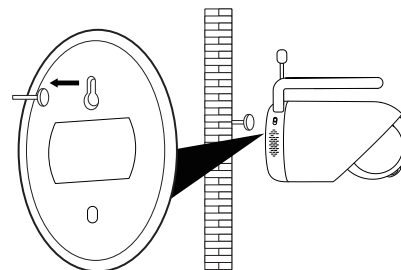

- It's strongly recommended to use a screw and screw anchor. Don't release the camera until you're sure it is firmly mounted.

# FUNCTIONS & OPERATIONS

## Monitor Interface overview

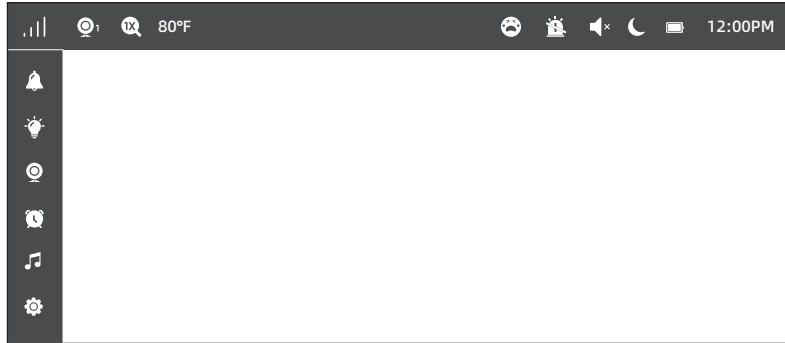

## Top Status Indications

	Signal	4 levels
	Current Camera	Camera 1 / Camera 2 / Camera 3/Camera 4
	Zoom	2X/4X
	Current Temperature	°C/ °F
	Cry Detection	???
	Warning	???
	Mute	Mute all system sounds
	Night Vision	Auto ON in a dim environment
	Battery	4 levels
PM12:00	Current Time	12Hr/24Hr

	Speaker Volume	0-7 levels
	Brightness	1-8 levels
	Camera	<ul style="list-style-type: none"> <li> To add (Max 4 Camera)</li> <li> Split</li> <li> Scan (select to view or scan each at a time)</li> <li> Delete cameras (select to delete camera)</li> </ul>
	Alarm	1 Hr/3 Hr/5 Hr/Set Time
	Lullaby	Accommodates 4 lullabies
	Settings	<ul style="list-style-type: none"> <li> Time</li> <li> Cry Detection</li> <li> Warning</li> <li> Temp Unit</li> <li> Display</li> <li> Language</li> <li> Reset</li> <li> Help</li> </ul>

## 1. Talkback

Press and hold the Talk button to talk to camera and release to exit. When monitor on Under Split Screen Mode: Press Left / Right Button to select the camera (Camera 1 or 2) you want to talk to. Hold to talk and release to exit.



- When you enter the talking mode, the icon will be shown on the monitor.
- When it's mute or the speaker volume is too low, you may not be able to hear the baby.
- When you're pressing the Talk Button, the camera will not transfer the sound to the monitor. Please release the button to listen to your baby.

## 2. Digital Zoom & Circulating

- 1) Under split screen mode, press Left / Right Button -> OK Button to select the camera (Camera 1 or 2) you want to view or zoom in.
- 2) Press Zoom Button to zoom in to 2X / 4X when viewing the camera. A third pressing of the button will restore to the original image.
- 3) Long press "OK" key for 3 seconds, the PTZ will cruise automatically twice, and then press "OK" key again to end the cruise.



The current zoom level number will be shown with the Zoom icon **1X** on the monitor

## 3. Pan-n-Tilt

When viewing the camera, press Left / Right / Up / Down Button to view at different angles, 108 degrees vertically and 350 degrees horizontally.

## 4. Night Vision

The night vision is automatically activated in a dim environment. The camera has high-intensity infrared LEDs for picking up clear images in the dark. Black and white images can be captured within 6m distance.

## 5. Volume Adjustment

- 1) Use the volume + - button on the top of monitor to quickly adjust the volume

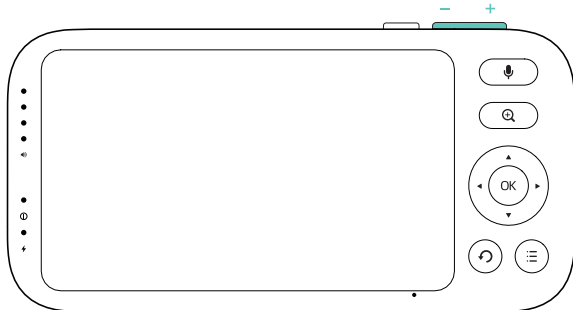

- 2) Or you can press Menu Button: Choose **▲** -> OK Button -> **◀** / **▶** Left / Right Button to volume down / up

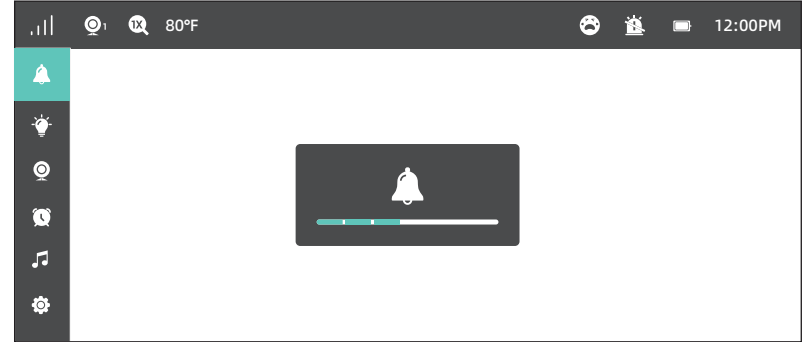

When the monitor is mute, you may not be able to hear the baby.

## 6. Display Brightness Adjustment

Press Menu Button: Choose **💡** -> OK Button -> Left / Right Button to adjust the brightness

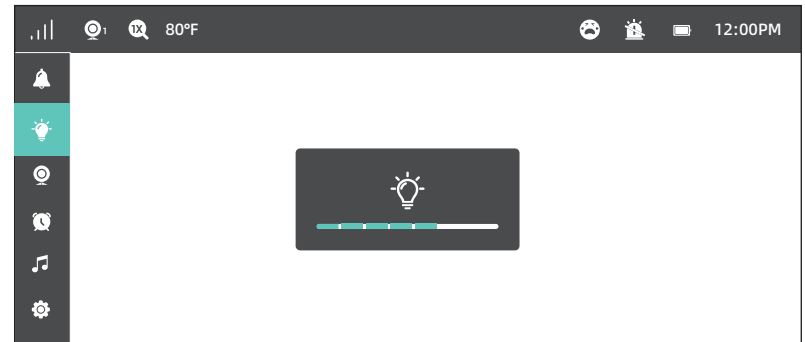

## 7.Camera

### Add Camera

1) Press Menu button, select through -> ADD -> to add a camera.

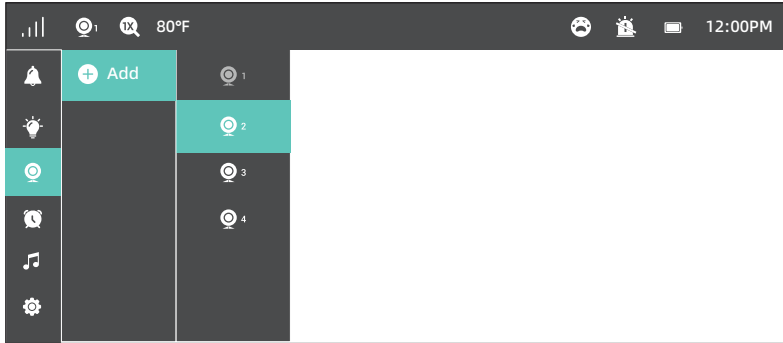

2) Press and hold the Pair Button on the camera for 3 seconds

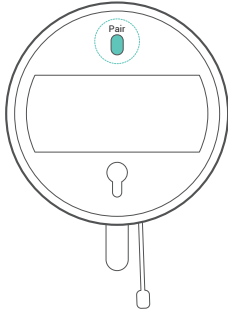

### Split Screen

1) Press Menu button, select through -> .

2) Then select two cameras (Camera 1/2/3/4) for Split screen display.

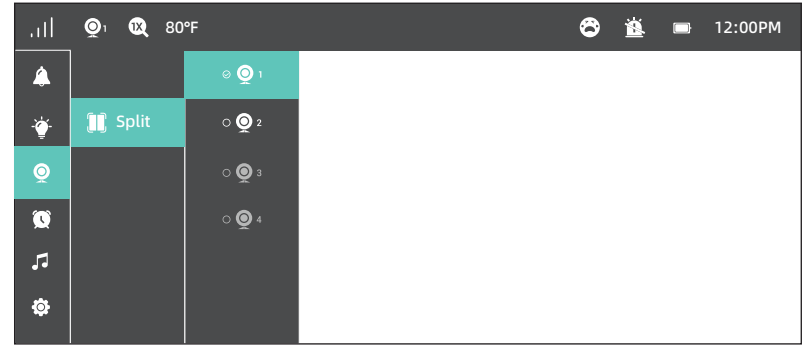

3) Once set, you can view two cameras at one time without delay. The sound of the two rooms will be switched every 15 seconds



4) Under Split screen mode, you can also press Left / Right Button -> Button to select one camera (Camera 1 or 2) you want to view or zoom in. Press the Button to return to Split screen mode.



## View Camera

- 1) Press Menu button, select through -> Scan-> to view a camera.  
·If there are 2 or more cameras, select to cyclethrough the added cameras every 15 seconds.  
·Select the camera number (1/2/3/4) to view the corresponding camera.

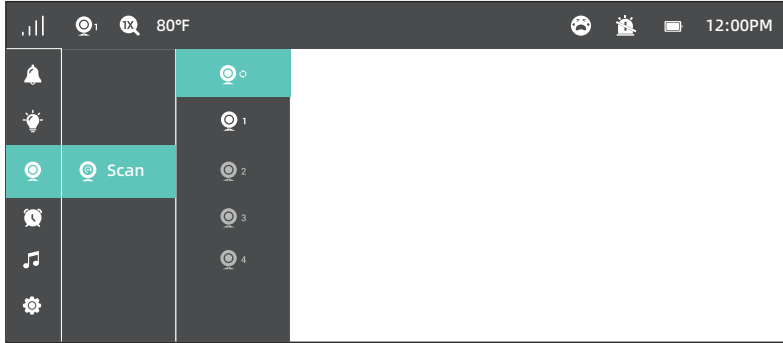

You can switch viewing different cameras; the current camera number will be shown with the Camera icon on the monitor.

## Delete Camera

- 1) Press Menu button, select through -> to delete a camera.

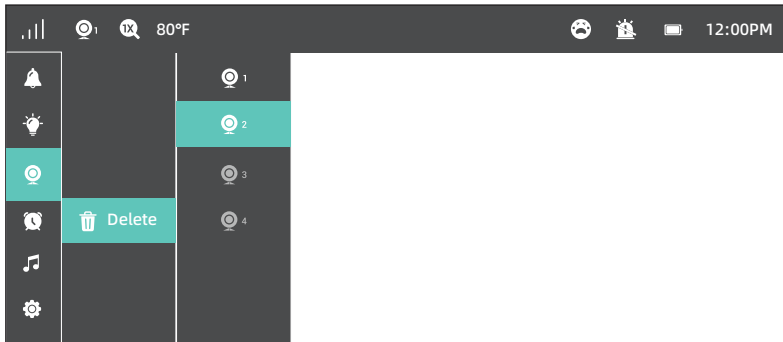

At least one camera shall be added. Do not delete all the cameras. If necessary, please add a new camera before deletion.

## 8. Alarm

- 1) Explanation:This function is to remind you of feeding your baby. OFF means you shut down the function; 3 hour means it reminds you every 3 hours and so on for the other options
- 2) Press Menu button, Choose -> 3Hr-> OK Button.
- 3) Select the time you want. or set the hour and minute otherwise. When the alarm time is reached, a beep will be heard. Press OK Button to stop; otherwise it'll keep beeping for 10s, beeping again in 1min, stops after it's alerted 4 times.

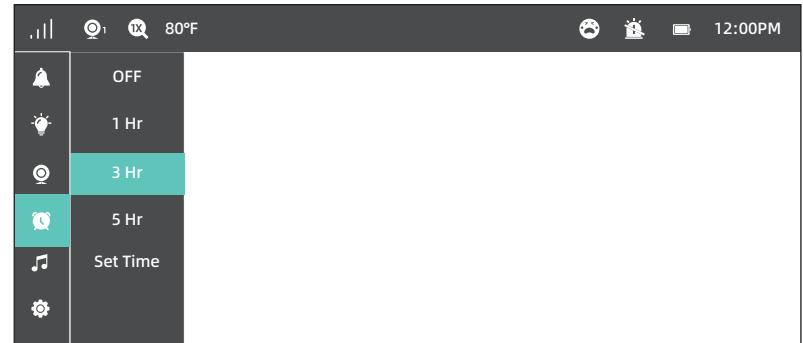

- When the timer is set, the Alarm icon will be shown on the monitor.
- Before setting, please check that the monitor time is your current time.

## 9. Lullabies

- 1) Explanation: This function is to comfort baby when needed.
- 2) Press Menu button, Choose 🎵 -> 🎵 Button.
- 3) Select the lullaby you want. Select 🎵 -> OK to play the lullabies in a loop, and press OK again to stop playing.
- 4) choose ◀ ▶ Left / Right Button to adjust the volume of the lullaby.

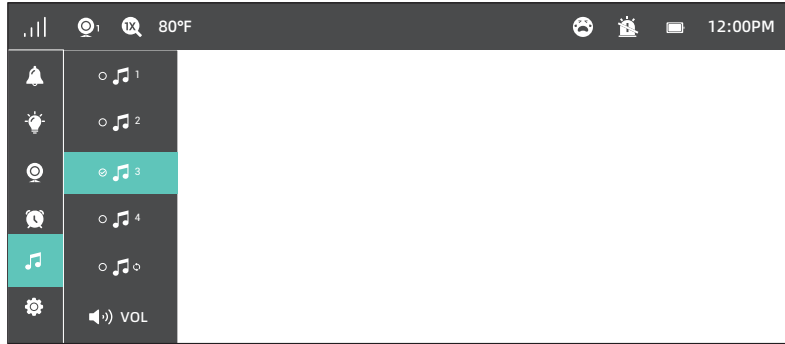

The lullaby will automatically stop looping after 1 hour

## 10. Cry Detection

- 1) Explanation:**
- There are three options of Cry detection, LOW 78dB, MEDIUM 65dB and 60dB. LOW HIGH means the sound of Baby cry can be detected if it reached 78dB, and so on for MEDIUM and HIGH.
  - Setting " off " turns off the alarm sound in Cry Detection mode.
- 2) Press Menu button, Choose Cry 🗸 -> OK Button.
  - 3) Select the option you want. Press OK Button.

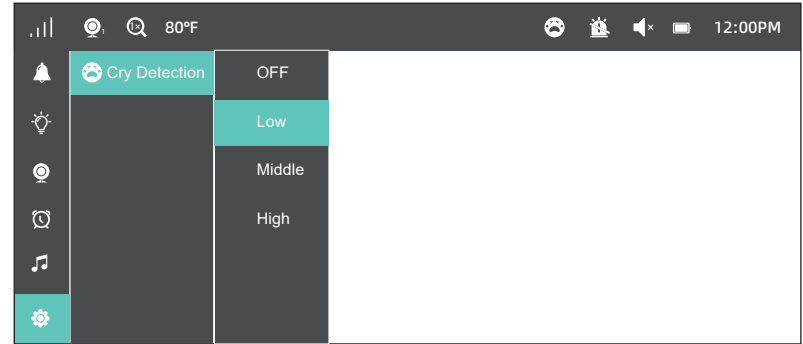

·When Cry Detection is turned off, the monitor will no longer emit an alarm sound, nor will it trigger a bright screen and icon alarm.

## 11. Temperature Alert

The monitor will prompt too high (>35°C / 95°F) and too low (<0°C / 32°F) temperatures with the "HH" and "LL" icon, accompanied with a 🌡️ & 🌡️ and a beep alert



when the monitor is mute, you may not be able to hear the baby

## 12. Monitor Settings

- Press Menu Button, Left and Right Buttons, and then OK Button to set the monitor
- 1) Time setting: Set the current time by setting hour, minute, and AM/ PM.
  - 2) Cry Detection: Automatically detect the baby's crying, wake up the display screen, and send out a prompt tone; the sensitivity can be set to OFF, Low, middle or High
  - 3) Warning volume: Select between Low, High, and Mute.
  - 4) Temperature unit: Select between °C and °F.
  - 5) Display (Screen auto-sleep time): Select between 1min, 2min, 5min, and Always on.

6)Language:English, French, German, Spanish, Italian

7)Reset: Press OK Button to confirm factory resetting screen;

"confirm factory resetting screen" will be shown when restoring, and you can't press any button to control the device during this period. The monitor will auto restart when it's done.

8)Help: Check the email for customer service

## SPECIFICATIONS

### Screen

Model	JT-VBM002
Resolution	IPS1920*1080 PPI=400
Image	16:9
Image compression	h.264
Operating Range	600m(antenna vertically positioned at 90°)
Temperature Alert	Yes
Baby Cry Alert	Yes
Volume Control	8 Levels
Brightness	8 Levels
Antenna	Rotatable (max. 90 degree)
Zoom	Zoom In (2X)
	Zoom In (4X)
Auto-Pilot	2 cycles
Two-Way Talk	Max. 4 cameras
Power Input	5V/2A (1.5m long USB C cable)
Storage Temperature	-10°C ~ 55°C / 14°F - 131°
Operation Temperature	0°C ~ 40°C / 32°F - 104°F

### Camera

Cmos	2K
Image compression	h.264
Pan-n-Tilt	108 degrees vertical (Up=90, Down=18) 270 degrees horizontal (Left=135, Right=135)
Zoom	Zoom In (2X) Zoom In (4X)
Auto-Pilot	2 cycles
View Angle	60°
Depth of Field	1.5m to 8m
Night Vision	Black & White image, 2m clear range, up to 8m
IR LED	Non-visible IR LED with wavelength 940nm
Light Sensor	Yes
Two-Way Talk	Yes
Temperature sensor	Yes
Power Input	5V/1.2A (1.5m long USB C cable)
Storage Temperature	-10°C ~ 55°C / 14°F - 131°
Operation Temperature	0°C ~ 40°C / 32°F - 104°F

## WARRANTY & CUSTOMER SERVICE

12 months warranty

Lifetime customer service (contacts on the monitor, and back cover of this User Guide)

# TROUBLESHOOTING

## 1.Product not powering on?

Check that the camera and monitor are turned on.

Check the camera is connected to power properly (it cannot be charged; it's power off once disconnected from power).

Check that the monitor is of enough battery (it'll auto shut off when battery level icon flashes red slowly on the monitor).

Check the intactness of the power cable.



## 2.Baby monitor can't connect with the camera?

Check whether the monitor is of low battery. Charge it in time to restore good connection.

Check whether the camera is well connected to power.

Check whether there are any large metallic objects including doors, refrigerators, mirrors, etc., are placed between the camera and monitor thus blocking the radio signals.

Check whether there's any other 900MHZ product is used nearby , which may interfere the connection.

Check whether the camera is placed on a metallic table Or put it directly on the ground  
If nothing above is involved, please retry to restart the monitor or to repair the camera:  
press the Pair Button at the bottom of the camera, press Menu button, select through  ->  , and then the monitor will auto-pair with the camera.

## 3.Too much noise?

-Volume may be set too high. Press volume - button which is on the top of the screen to volume down

-Microphone feedback might occur when the monitor is too close to the camera. Please keep them at least 1.5m / 4.9ft apart.

-The camera may be too out of range. Please keep it within 10m / 32.8ft to the monitor.

## 4.The Video is not clear?

-Make sure the camera lens and display screen are clean, otherwise you can use a lens cloth to wipe them.

-Confirm that the camera is not obstructed around

## 4. Black and white pictures?

Night vision LED may be ON. Please turn on room lights to force it out of the night mode.

## 5.Choppy videos?

-Check whether the camera is near the monitor and that there're no obstacles between them.

-Adjust the monitor antenna to vertical position for better signal transfer.

## Operating bands(Tx and Rx) and maximum power

Frequency Band(s):

902MHz-928MHz(TX/RX)

Maximum output power:

Jartoo Baby Monitor: 0.6266W

Jartoo Baby Camera: 0.4256W

# FCC STATEMENT

## FCC Radiation Exposure Statement:

For Jartoo Baby Monitor:

This equipment complies with FCC radiation exposure limits set forth for an uncontrolled environment. This equipment should be installed and operated with minimum distance 0cm between the radiator & your body.

For Jartoo Baby Camera:

This equipment complies with FCC radiation exposure limits set forth for an uncontrolled environment. This equipment should be installed and operated with minimum distance 20cm between the radiator & your body.