

FCC PART 15 SUBPART C TEST REPORT

FCC PART 15.247

Report Reference No..... : BSL24010193P01-R02

FCC ID..... : 2BEZXMOKX-1

Compiled by
(position+printed name+signature)..: Engineer/ Cindy Zheng

Cindy Zheng

Supervised by
(position+printed name+signature)..: Manager/Haley Wen

Haley Wen

Approved by
(position+printed name+signature)..: RF Manager/ Vivian Jiang

Vivian Jiang

Date of issue.....: April 8, 2024

Testing Laboratory Name.....: BSL Testing Co., Ltd.

Address.....: 1/F, Building B, Xinshidai GR Park,Shiyan Street, Bao'an District, Shenzhen,Guangdong, 518052, People's Republic of China

Applicant's name.....: Shenzhen Meiyaxuan Technology Co., Ltd

Address.....: 2/F, Building B, Factory Building, Area C, Shangxue Science and Technology Industrial City, Xinxue Community, Bantian Street, Longgang District, Shenzhen

Test specification..... :

FCC Part 15.247

ANSI C63.10:2013

Standard.....: **KDB558074 D01 v05r02**

KDB353028 D01v01r01

KDB662911 D01 v02r01

BSL Testing Co., Ltd. All rights reserved.

This publication may be reproduced in whole or in part for non-commercial purposes as long as the BSL Testing Co., Ltd.is acknowledged as copyright owner and source of the material. BSL Testing Co., Ltd.takes no responsibility for and will not assume liability for damages resulting from the reader's interpretation of the reproduced material due to its placement and context.

Test item description.....: Repeater

Trade Mark.....: MOKBOXES

Manufacturer.....: Shenzhen Meiyaxuan Technology Co., Ltd

Model/Type reference.....: MOKX-1

Listed Models: MOKX-2, MOKX-3, MOKX-4, MOKX-5, MOKX-6, MOKX-7, MOKX-8, MOKX-9, MOKX-10, MOKX-11, MOKX-12, MOKX-13, MOKX-14, MOKX-15, MOKX-16, MOKX-17, MOKX-18, MOKX-19, MOKX-20, MOKX-21, MOKX-22, MOKX-23, MOKX-24, MOKX-25, MOKX-26, MOKX-27, MOKX-28, MOKX-29, MOKX-30

Modulation Type.....: CCK/DSSS/ OFDM

Operation Frequency.....: From 2412 - 2462MHz

Rating.....: AC 120V

Result.....: **PASS**

TEST REPORT

Equipment under Test : **Repeater**

Model /Type : MOKX-1

Series Model No. MOKX-2, MOKX-3, MOKX-4, MOKX-5, MOKX-6, MOKX-7, MOKX-8, MOKX-9, MOKX-10, MOKX-11, MOKX-12, MOKX-13, MOKX-14, MOKX-15, MOKX-16, MOKX-17, MOKX-18, MOKX-19, MOKX-20, MOKX-21, MOKX-22, MOKX-23, MOKX-24, MOKX-25, MOKX-26, MOKX-27, MOKX-28, MOKX-29, MOKX-30

Model Declaration : All the models are electrical identical including the same software parameter and hardware design, same mechanical structure and design, the only difference is the model named different.

Applicant : **Shenzhen Meiyaxuan Technology Co., Ltd**

Address : 2/F, Building B, Factory Building, Area C, Shangxue Science and Technology Industrial City, Xinxue Community, Bantian Street, Longgang District, Shenzhen

Manufacturer : **Shenzhen Meiyaxuan Technology Co., Ltd**

Address : 2/F, Building B, Factory Building, Area C, Shangxue Science and Technology Industrial City, Xinxue Community, Bantian Street, Longgang District, Shenzhen

Test Result:	PASS
---------------------	-------------

The test report merely corresponds to the test sample.
It is not permitted to copy extracts of these test result without the written permission of the test laboratory.

Contents

1	TEST STANDARDS	4
2	SUMMARY	5
2.1	General Remarks	5
2.2	Product Description	5
2.3	Equipment Under Test	5
2.4	Short description of the Equipment under Test (EUT)	6
2.5	EUT operation mode	6
2.6	Block Diagram of Test Setup	6
2.7	Related Submittal(s) / Grant (s)	6
2.8	Modifications	6
3	TEST ENVIRONMENT	7
3.1	Address of the test laboratory	7
3.2	Test Facility	7
3.3	Environmental conditions	7
3.4	Test Description	8
3.5	Statement of the measurement uncertainty	8
3.6	Equipments Used during the Test	9
4	TEST CONDITIONS AND RESULTS	11
4.1	AC Power Conducted Emission	11
4.2	Radiated Emission	14
4.3	Maximum Peak Conducted Output Power	22
4.4	Power Spectral Density	24
4.5	6dB Bandwidth	33
4.6	Out-of-band Emissions	42
4.7	Antenna Requirement	49
5	TEST SETUP PHOTOS OF THE EUT	50
6	PHOTOS OF THE EUT	51

1 TEST STANDARDS

The tests were performed according to following standards:

[FCC Rules Part 15.247](#): Frequency Hopping, Direct Spread Spectrum and Hybrid Systems that are in operation within the bands of 902-928 MHz, 2400-2483.5 MHz, and 5725-5850 MHz.

[ANSI C63.10-2013](#): American National Standard for Testing Unlicensed Wireless Devices

[KDB558074 D01 v05r02](#): Guidance for Compliance Measurements on Digital Transmission Systems (DTS) ,Frequency Hopping Spread Spectrum System(HFSS), and Hybrid System Devices Operating Under §15.247 of The FCC rules.

[KDB353028 D01v01r01](#): BASIC EQUIPMENT AUTHORIZATION GUIDANCE FOR ANTENNAS USED WITH PART 15 INTENTIONAL RADIATORS

[KDB662911 D01v02r01](#) : Multiple Transmitter Output v02r01

2 SUMMARY

2.1 General Remarks

Date of receipt of test sample	:	February 18, 2024
Testing commenced on	:	February 18, 2024
Testing concluded on	:	April 8, 2024

2.2 Product Description

Product Name:	Repeater
Model/Type reference:	MOKX-1
Power supply:	AC 120V
Adapter information	N/A
Testing sample ID:	BSL24010193P01-R02-1# (Engineer sample), BSL24010193P01-R02-2# (Normal sample)
Hardware version:	V2.2
Software version:	1.112.e65c9d3c
WIFI :	
Supported type:	802.11b/802.11g/802.11n(H20)/ 802.11n(H40)
Modulation:	802.11b: DSSS 802.11g/802.11n(H20)/ 802.11n(H40): OFDM
Operation frequency:	802.11b/802.11g/802.11n(H20): 2412MHz~2462MHz 802.11n(H40): 2422MHz~2452MHz
Channel number:	802.11b/802.11g/802.11n(H20): 11 802.11n(H40):7
Channel separation:	5MHz
Antenna type:	PCB Antenna
Antenna gain:	ANT 1: 1.15 dBi ANT 2: 1.15 dBi ANT 3: 1.15 dBi ANT 4: 1.15 dBi
	The 2.4GHz WIFI has 4 antennas and support Multiple Outputs for 802.11n mode for this report; Antenna 1/2/3/4 Gain is 1.15dBi; For this function is belong to Correlated Categorization equipment According to KDB 662911, for same directional gain. Directional gain = $G_{ANT} + 10 \log(N_{ANT})$ dBi = $1.15+10\log(4)$ dBi=7.17dBi

2.3 Equipment Under Test

Power supply system utilised

Power supply voltage	:	<input type="radio"/> 230V / 50 Hz	<input checked="" type="radio"/> 120V / 60Hz
		<input type="radio"/> 12 V DC	<input type="radio"/> 24 V DC
		<input type="radio"/> Other (specified in blank below)	

2.4 Short description of the Equipment under Test (EUT)

This is MOKX-1 Repeater.

For more details, refer to the user's manual of the EUT.

2.5 EUT operation mode

The application provider specific test software(MP_Kit_RTL11n_FTV_USB_v1.25) to control sample in continuous TX and RX (Duty Cycle >98%) for testing meet KDB558074 test requirement.

IEEE 802.11b/g/n: Thirteen channels are provided to the EUT.

IEEE 802.11n(H40): Seven channels are provided to the EUT.

IEEE 802.11b/g/n

Channel	Frequency(MHz)	Channel	Frequency(MHz)
1	2412	8	2447
2	2417	9	2452
3	2422	10	2457
4	2427	11	2462
5	2432		
6	2437		
7	2442		

IEEE 802.11n(H40)

Channel	Frequency(MHz)		
3	2422		
4	2427		
5	2432		
6	2437		
7	2442		
8	2447		
9	2452		

2.6 Block Diagram of Test Setup

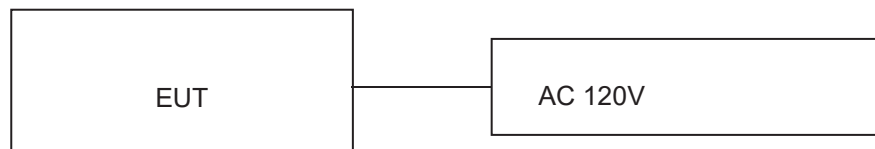

2.7 Related Submittal(s) / Grant (s)

This submittal(s) (test report) is intended for filing to comply with Section 15.247 of the FCC Part 15, Subpart C Rules.

2.8 Modifications

No modifications were implemented to meet testing criteria.

3 TEST ENVIRONMENT

3.1 Address of the test laboratory

BSL Testing Co., Ltd.

1/F, Building B, Xinshidai GR Park,Shiyan Street, Bao'an District, Shenzhen,Guangdong, 518052, People's Republic of China

3.2 Test Facility

FCC-Registration No.: 562200 Designation Number: CN1338

BSL Testing Co.,Ltd. has been listed on the US Federal Communications Commission list of test facilities recognized to perform electromagnetic emissions measurements.

Industry Canada Registration Number. Is: 11093A CAB identifier: CN0019

The Laboratory has been registered by Certification and Engineering Bureau of Industry Canada for radio equipment testing.

A2LA-Lab Cert. No.: 4707.01

BSL Testing Co.,Ltd. has been listed by American Association for Laboratory Accreditation to perform electromagnetic emission measurement.

The 3m-Semi anechoic test site fulfils CISPR 16-1-4 according to ANSI C63.10 and CISPR 16-1-4:2010.

3.3 Environmental conditions

During the measurement the environmental conditions were within the listed ranges:

Radiated Emission:

Temperature:	25 ° C
Humidity:	45 %
Atmospheric pressure:	950-1050mbar

Conducted testing:

Temperature:	25 ° C
Humidity:	44 %
Atmospheric pressure:	950-1050mbar

AC Power Conducted Emission

Temperature:	24 ° C
Humidity:	44 %
Atmospheric pressure:	950-1050mbar

3.4 Test Description

FCC PART 15.247		
FCC Part 15.207	AC Power Conducted Emission	PASS
FCC Part 15.247(a)(2)	6dB Bandwidth	PASS
FCC Part 15.247(d)	Spurious RF Conducted Emission	PASS
FCC Part 15.247(b)	Maximum Peak Conducted Output Power	PASS
FCC Part 15.247(e)	Power Spectral Density	PASS
FCC Part 15.109/ 15.205/ 15.209	Radiated Emissions	PASS
FCC Part 15.247(d)	Band Edge	PASS
FCC Part 15.203/15.247 (b)	Antenna Requirement	PASS

Data Rate Used:

Preliminary tests were performed in different data rate to find the worst radiated emission. The data rate shown in the table below is the worst-case rate with respect to the specific test item. Investigation has been done on all the possible configurations for searching the worst cases. The following table is a list of the test modes shown in this test report.

Test Items	Mode	Data Rate	Channel
Maximum Peak Conducted Output Power Power Spectral Density 6dB Bandwidth Spurious RF conducted emission Radiated Emission 9KHz~1GHz& Radiated Emission 1GHz~10 th Harmonic	11b/DSSS	1 Mbps	1/6/11
	11g/OFDM	6 Mbps	1/6/11
	11n(20MHz)/OFDM	6.5Mbps	1/6/11
	11n(40MHz)/OFDM	13.5Mbps	3/6/9
Band Edge	11b/DSSS	1 Mbps	1/11
	11g/OFDM	6 Mbps	1/11
	11n(20MHz)/OFDM	6.5Mbps	1/11
	11n(40MHz)/OFDM	13.5Mbps	3/9

3.5 Statement of the measurement uncertainty

The data and results referenced in this document are true and accurate. The reader is cautioned that there may be errors within the calibration limits of the equipment and facilities. The measurement uncertainty was calculated for all measurements listed in this test report acc. to TR-100028-01 "Electromagnetic compatibility and Radio spectrum Matters (ERM);Uncertainties in the measurement of mobile radio equipment characteristics; Part 1" and TR-100028-02 "Electromagnetic compatibility and Radio spectrum Matters (ERM);Uncertainties in the measurement of mobile radio equipment characteristics; Part 2 " and is documented in the BSL Testing Co., Ltd.quality system acc. to DIN EN ISO/IEC 17025. Furthermore, component and process variability of devices similar to that tested may result in additional deviation. The manufacturer has the sole responsibility of continued compliance of the device.

Hereafter the best measurement capability for BSL Testing Co., Ltd.

Test	Range	Measurement Uncertainty	Notes
Radiated Emission	30~1000MHz	4.06 dB	(1)
Radiated Emission	1~18GHz	5.14 dB	(1)
Radiated Emission	18-40GHz	5.38 dB	(1)
Conducted Disturbance	0.15~30MHz	2.14 dB	(1)

(1) This uncertainty represents an expanded uncertainty expressed at approximately the 95% confidence level using a coverage factor of k=2.

3.6 Equipments Used during the Test

Conducted Emission					
Test Equipment	Manufacturer	Model	Serial No.	Date of Cal.	Due Date
Shielding Room	ZhongYu Electron	7.3(L)x3.1(W)x2.9(H)	BSL252	2023-10-28	2024-10-27
EMI Test Receiver	R&S	ESCI 7	BSL552	2023-10-28	2024-10-27
Coaxial Switch	ANRITSU CORP	MP59B	BSL225	2023-10-28	2024-10-27
ENV216 2-L-V-NETZNACHB.DE	ROHDE&SCHWARZ	ENV216	BSL226	2023-10-28	2024-10-27
Coaxial Cable	BSL	N/A	BSL227	N/A	N/A
EMI Test Software	AUDIX	E3	N/A	N/A	N/A
Thermo meter	KTJ	TA328	BSL233	2023-10-28	2024-10-27
Absorbing clamp	Elektronik-Feinmechanik	MDS21	BSL229	2023-10-28	2024-10-27
LISN	R&S	ENV216	308	2023-10-28	2024-10-27
LISN	R&S	ENV216	314	2023-10-28	2024-10-27

Radiation Test equipment					
Test Equipment	Manufacturer	Model	Serial No.	Date of Cal.	Due Date
3m Semi- Anechoic Chamber	ZhongYu Electron	9.2(L)*6.2(W)* 6.4(H)	BSL250	2023-10-28	2024-10-27
Control Room	ZhongYu Electron	6.2(L)*2.5(W)* 2.4(H)	BSL251	N/A	N/A
EMI Test Receiver	Rohde & Schwarz	ESU26	BSL203	2023-10-28	2024-10-27
BiConiLog Antenna	SCHWARZBECK MESS-ELEKTRONIK	VULB9163	BSL214	2023-10-28	2024-10-27
Double -ridged waveguide horn	SCHWARZBECK MESS-ELEKTRONIK	BBHA 9120 D	BSL208	2023-10-28	2024-10-27
Horn Antenna	ETS-LINDGREN	3160	BSL217	2023-10-28	2024-10-27
EMI Test Software	AUDIX	E3	N/A	N/A	N/A
Coaxial Cable	BSL	N/A	BSL213	2023-10-28	2024-10-27
Coaxial Cable	BSL	N/A	BSL211	2023-10-28	2024-10-27
Coaxial cable	BSL	N/A	BSL210	2023-10-28	2024-10-27
Coaxial Cable	BSL	N/A	BSL212	2023-10-28	2024-10-27
Amplifier(100kHz-3GHz)	HP	8347A	BSL204	2023-10-28	2024-10-27
Amplifier(2GHz-20GHz)	HP	84722A	BSL206	2023-10-28	2024-10-27
Amplifier (18-26GHz)	Rohde & Schwarz	AFS33-18002 650-30-8P-44	BSL218	2023-10-28	2024-10-27
Band filter	Amindeon	82346	BSL219	2023-10-28	2024-10-27
Power Meter	Anritsu	ML2495A	BSL540	2023-10-28	2024-10-27
Power Sensor	Anritsu	MA2411B	BSL541	2023-10-28	2024-10-27
Wideband Radio Communication Tester	Rohde & Schwarz	CMW500	BSL575	2023-10-28	2024-10-27
Splitter	Agilent	11636B	BSL237	2023-10-28	2024-10-27
Loop Antenna	ZHINAN	ZN30900A	BSL534	2023-10-28	2024-10-27



Breitband hornantenne	SCHWARZBECK	BBHA 9170	BSL579	2023-10-28	2024-10-27
Amplifier	TDK	PA-02-02	BSL574	2023-10-28	2024-10-27
Amplifier	TDK	PA-02-03	BSL576	2023-10-28	2024-10-27
PSA Series Spectrum Analyzer	Rohde & Schwarz	FSP	BSL578	2023-10-28	2024-10-27

RF Conducted Test:					
Test Equipment	Manufacturer	Model	Serial No.	Date of Cal.	Due Date
MXA Signal Analyzer	Agilent	N9020A	BSL566	2023-10-28	2024-10-27
EMI Test Receiver	R&S	ESCI 7	BSL552	2023-10-28	2024-10-27
Spectrum Analyzer	Agilent	E4440A	BSL533	2023-10-28	2024-10-27
MXG vector Signal Generator	Agilent	N5182A	BSL567	2023-10-28	2024-10-27
ESG Analog Signal Generator	Agilent	E4428C	BSL568	2023-10-28	2024-10-27
USB RF Power Sensor	DARE	RPR3006W	BSL569	2023-10-28	2024-10-27
RF Switch Box	Shongyi	RFSW3003328	BSL571	2023-10-28	2024-10-27
Programmable Constant Temp & Humi Test Chamber	WEWON	WHTH-150L-40-880	BSL572	2023-10-28	2024-10-27

4 TEST CONDITIONS AND RESULTS

4.1 AC Power Conducted Emission

TEST CONFIGURATION

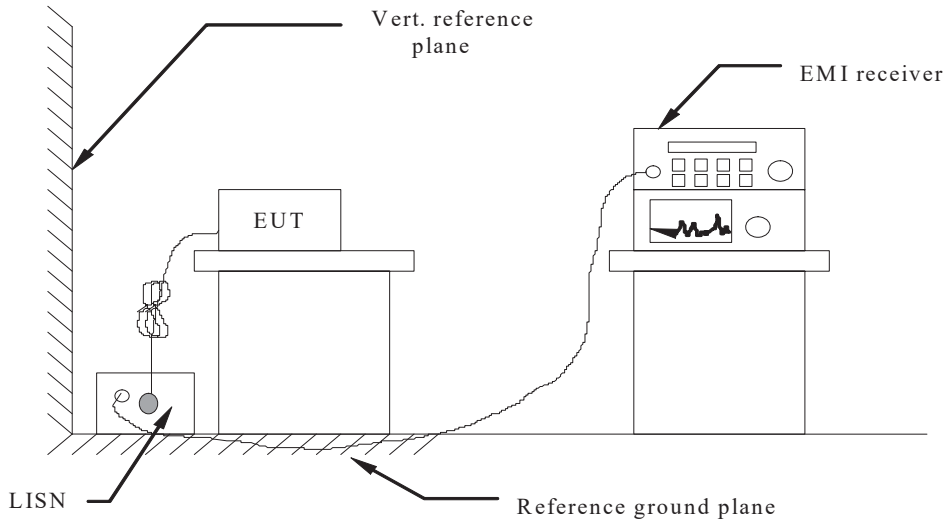

TEST PROCEDURE

- 1 The equipment was set up as per the test configuration to simulate typical actual usage per the user's manual. The EUT is a tabletop system, a wooden table with a height of 0.8 meters is used and is placed on the ground plane as per ANSI C63.10-2013.
- 2 Support equipment, if needed, was placed as per ANSI C63.10-2013
- 3 All I/O cables were positioned to simulate typical actual usage as per ANSI C63.10-2013
- 4 The EUT received power from adapter, the adapter received AC120V/60Hz and AC 240V/60Hz power through a Line Impedance Stabilization Network (LISN) which supplied power source and was grounded to the ground plane.
- 5 All support equipments received AC power from a second LISN, if any.
- 6 The EUT test program was started. Emissions were measured on each current carrying line of the EUT using a spectrum Analyzer / Receiver connected to the LISN powering the EUT. The LISN has two monitoring points: Line 1 (Hot Side) and Line 2 (Neutral Side). Two scans were taken: one with Line 1 connected to Analyzer / Receiver and Line 2 connected to a 50 ohm load; the second scan had Line 1 connected to a 50 ohm load and Line 2 connected to the Analyzer / Receiver.
- 7 Analyzer / Receiver scanned from 150 KHz to 30MHz for emissions in each of the test modes.
- 8 During the above scans, the emissions were maximized by cable manipulation.

AC Power Conducted Emission Limit

For intentional device, according to § 15.207(a) AC Power Conducted Emission Limits is as following:

Frequency range (MHz)	Limit (dBuV)	
	Quasi-peak	Average
0.15-0.5	66 to 56*	56 to 46*
0.5-5	56	46
5-30	60	50

* Decreases with the logarithm of the frequency.

TEST RESULTS

Power supply:	AC 120V/60Hz	Polarization	L
---------------	--------------	--------------	---

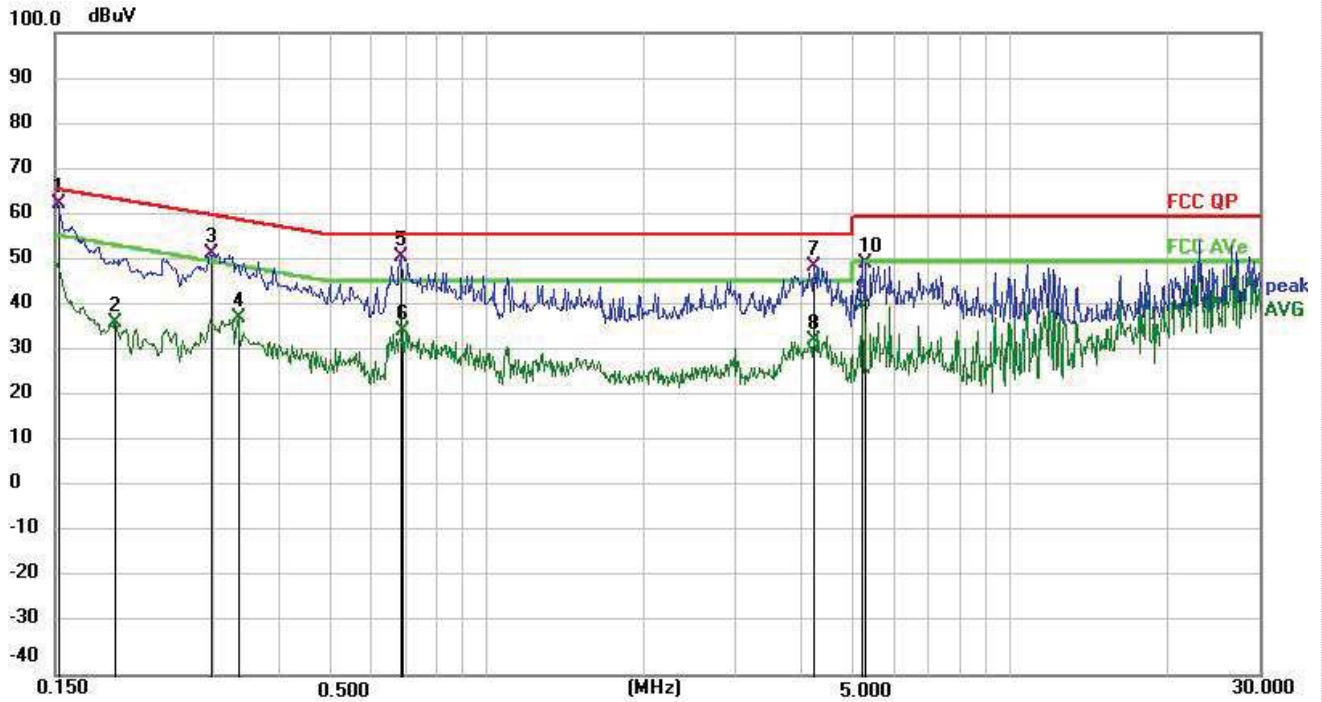

No.	Frequency (MHz)	Reading (dBuV)	Factor (dB)	Level (dBuV)	Limit (dBuV)	Margin (dB)	Detector	P/F
1 *	0.1515	45.98	16.59	62.57	65.92	-3.35	QP	P
2	0.1944	20.04	16.73	36.77	53.85	-17.08	AVG	P
3	0.2971	35.25	16.71	51.96	60.32	-8.36	QP	P
4	0.3345	21.13	16.71	37.84	49.34	-11.50	AVG	P
5	0.6854	34.66	16.66	51.32	56.00	-4.68	QP	P
6	0.6945	18.57	16.65	35.22	46.00	-10.78	AVG	P
7	4.2270	33.00	16.19	49.19	56.00	-6.81	QP	P
8	4.2270	16.65	16.19	32.84	46.00	-13.16	AVG	P
9	5.2350	24.63	16.15	40.78	50.00	-9.22	AVG	P
10	5.2980	33.75	16.16	49.91	60.00	-10.09	QP	P

- Note:1). Level (dBμV)= Reading (dBμV)+ Factor (dB)
 2). Factor (dB)=insertion loss of LISN (dB) + Cable loss (dB)
 3). Margin(dB) = Limit (dBμV) - Level (dBμV)

Power supply:	DC 12V from Adapter AC 120V/60Hz	Polarization	N
---------------	-------------------------------------	--------------	---

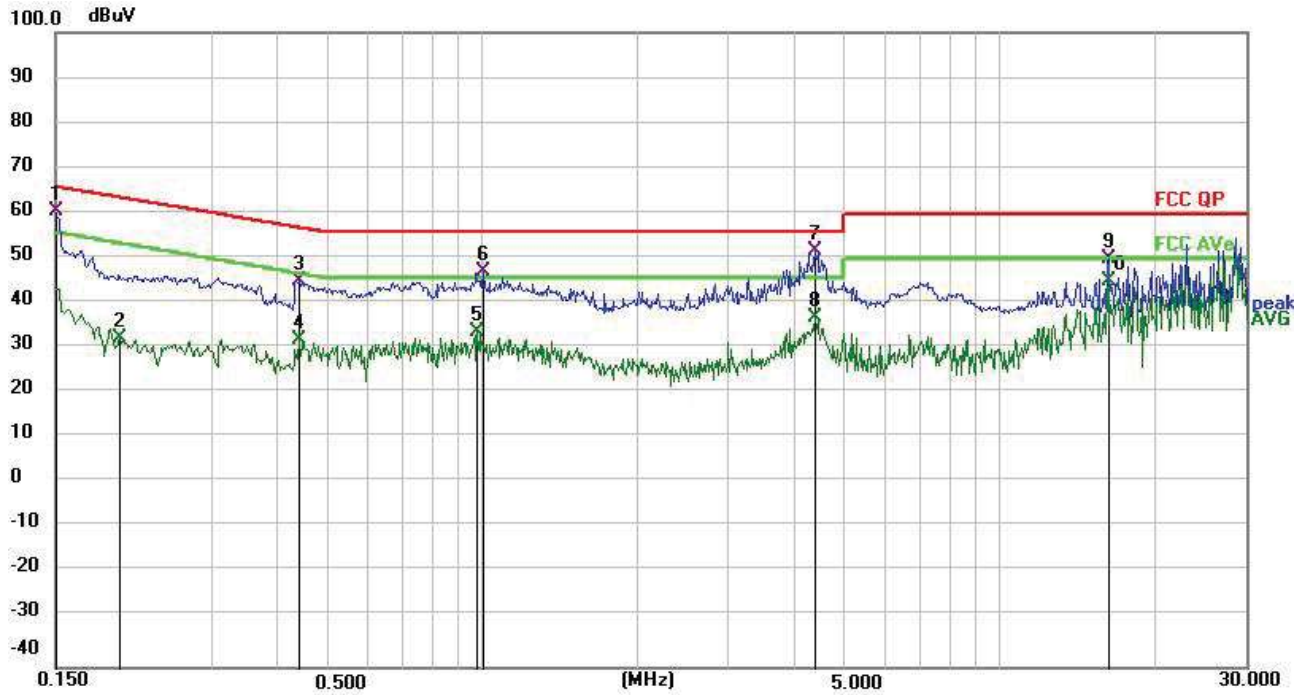

No.	Frequency (MHz)	Reading (dBuV)	Factor (dB)	Level (dBuV)	Limit (dBuV)	Margin (dB)	Detector	P/F
1	0.1500	43.16	17.53	60.69	66.00	-5.31	QP	P
2	0.1995	15.12	17.53	32.65	53.63	-20.98	AVG	P
3	0.4420	27.77	17.52	45.29	57.02	-11.73	QP	P
4	0.4425	14.89	17.52	32.41	47.01	-14.60	AVG	P
5	0.9825	16.51	17.51	34.02	46.00	-11.98	AVG	P
6	1.0095	29.77	17.50	47.27	56.00	-8.73	QP	P
7 *	4.4115	34.33	17.41	51.74	56.00	-4.26	QP	P
8	4.4115	19.89	17.41	37.30	46.00	-8.70	AVG	P
9	16.2285	30.99	19.07	50.06	60.00	-9.94	QP	P
10	16.2285	26.02	19.07	45.09	50.00	-4.91	AVG	P

Note:1).Level (dBμV)= Reading (dBμV)+ Factor (dB)
 2). Factor (dB)=insertion loss of LISN (dB) + Cable loss (dB)
 3). Margin(dB) = Limit (dBμV) - Level (dBμV)

4.2 Radiated Emission

TEST CONFIGURATION

Frequency range 9KHz – 30MHz

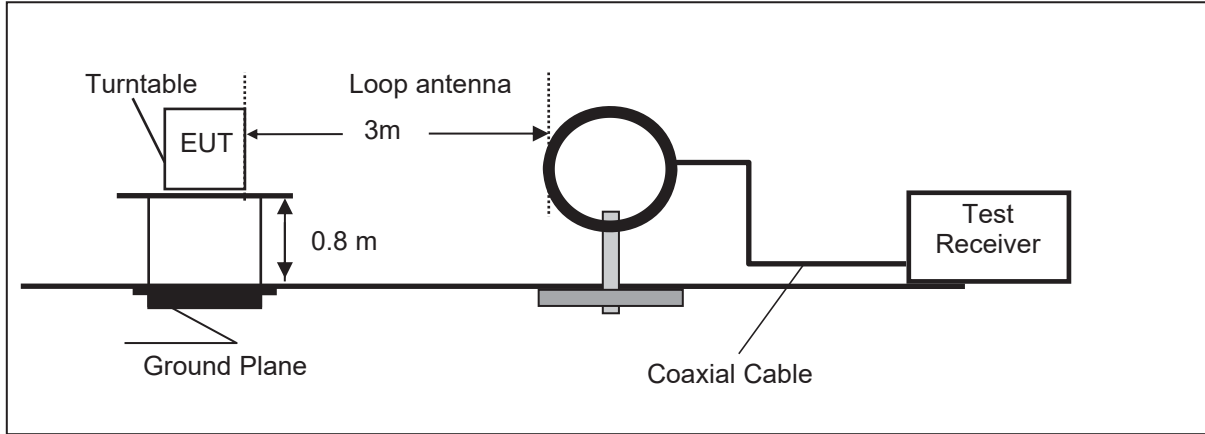

Frequency range 30MHz – 1000MHz

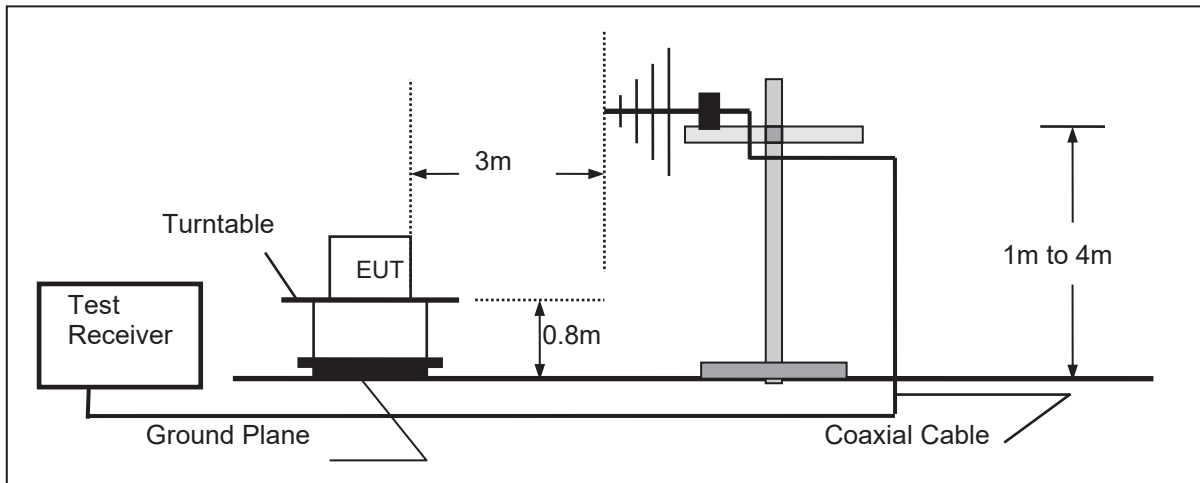

Frequency range above 1GHz-25GHz

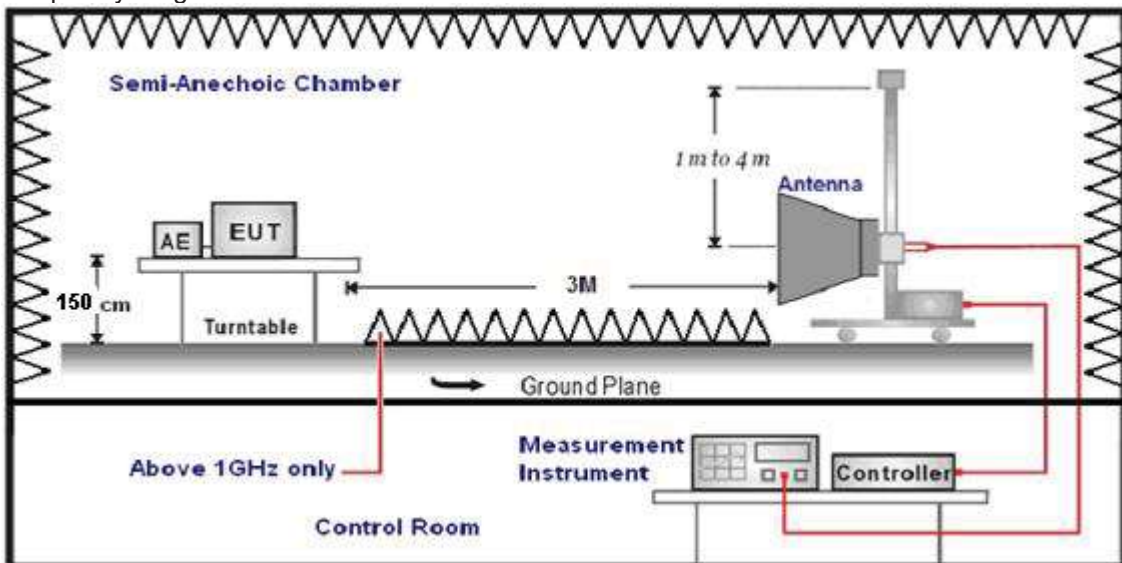

TEST PROCEDURE

1. The EUT was placed on a turn table which is 0.8m above ground plane when testing frequency range 9 KHz –1GHz;the EUT was placed on a turn table which is 1.5m above ground plane when testing frequency range 1GHz – 25GHz.
2. Maximum procedure was performed by raising the receiving antenna from 1m to 4m and rotating the turn table from 0° to 360° to acquire the highest emissions from EUT.
3. And also, each emission was to be maximized by changing the polarization of receiving antenna both horizontal and vertical.
4. Repeat above procedures until all frequency measurements have been completed.
5. Radiated emission test frequency band from 9KHz to 25GHz.
6. The distance between test antenna and EUT as following table states:

Test Frequency range	Test Antenna Type	Test Distance
9KHz-30MHz	Active Loop Antenna	3
30MHz-1GHz	Ultra-Broadband Antenna	3
1GHz-18GHz	Double Ridged Horn Antenna	3
18GHz-25GHz	Horn Antenna	1

7. Setting test receiver/spectrum as following table states:

Test Frequency range	Test Receiver/Spectrum Setting	Detector
9KHz-150KHz	RBW=200Hz/VBW=3KHz, Sweep time=Auto	QP
150KHz-30MHz	RBW=9KHz/VBW=100KHz, Sweep time=Auto	QP
30MHz-1GHz	RBW=120KHz/VBW=1000KHz, Sweep time=Auto	QP
1GHz-40GHz	Peak Value: RBW=1MHz/VBW=3MHz, Sweep time=Auto Average Value: RBW=1MHz/VBW=10Hz, Sweep time=Auto	Peak

Field Strength Calculation

The field strength is calculated by adding the Antenna Factor and Cable Factor and subtracting the Amplifier Gain and Duty Cycle Correction Factor(if any) from the measured reading. The basic equation with a sample calculation is as follows:

$$FS = RA + AF + CL - AG$$

Where FS = Field Strength	CL = Cable Attenuation Factor (Cable Loss)
RA = Reading Amplitude	AG = Amplifier Gain
AF = Antenna Factor	

$$Transd=AF +CL-AG$$

RADIATION LIMIT

For intentional device, according to § 15.209(a), the general requirement of field strength of radiated emission from intentional radiators at a distance of 3 meters shall not exceed the following table. According to § 15.247(d), in any 100kHz bandwidth outside the frequency band in which the EUT is operating, the radio frequency power that is produced by the intentional radiator shall be at least 20dB below that in the100kHz bandwidth within the band that contains the highest level of desired power.

The pre-test have done for the EUT in three axes and found the worst emission at position shown in test setup photos.

Frequency (MHz)	Distance (Meters)	Radiated (dBµV/m)	Radiated (µV/m)
0.009-0.49	3	20log(2400/F(KHz))+40log(300/3)	2400/F(KHz)
0.49-1.705	3	20log(24000/F(KHz))+ 40log(30/3)	24000/F(KHz)
1.705-30	3	20log(30)+ 40log(30/3)	30
30-88	3	40.0	100
88-216	3	43.5	150
216-960	3	46.0	200
Above 960	3	54.0	500

TEST RESULTS

Remark:

1. This test was performed with EUT in X, Y, Z position and the worse case was found when EUT in X position.
2. All three channels (lowest/middle/highest) of each mode were measured below 1GHz and recorded worst case at 802.11b low channel.
3. The emission from 9 kHz to 30MHz was pre-tested and found the result was 20dB lower than the limit, and according to 15.31(o) & RSS-Gen 6.13, the test result no need to reported.

For 30MHz-1GHz

Note:Pre-scan all mode, ANT 1 Power> ANT 2 Power> ANT 3 Power> ANT 4 Power, Both ANT 1, 2, 3 and 4 have been test, Only show the worst data of ANT 1.

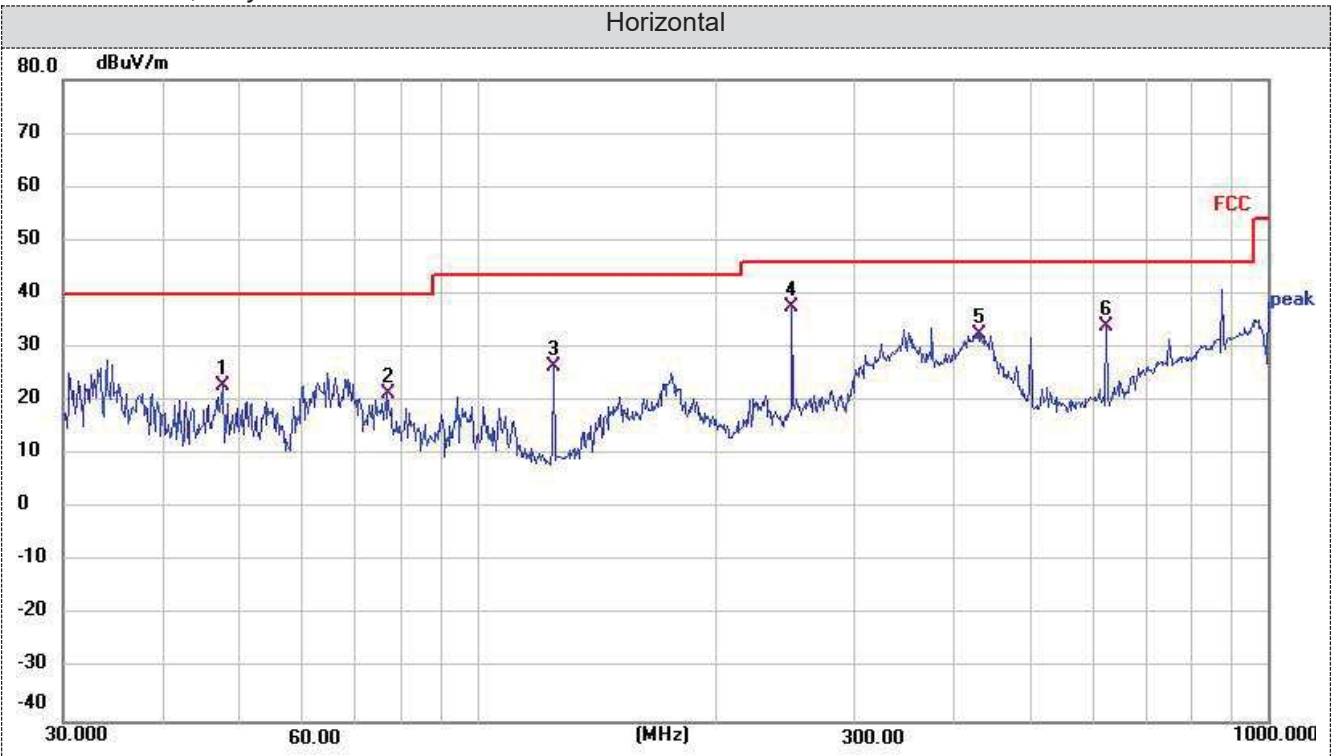

No.	Frequency (MHz)	Reading (dBuV)	Factor (dB/m)	Level (dBuV/m)	Limit (dBuV/m)	Margin (dB)	Detector
1	47.8260	39.43	-16.45	22.98	40.00	-17.02	QP
2	77.0503	41.42	-20.06	21.36	40.00	-18.64	QP
3	125.0065	43.89	-17.56	26.33	43.50	-17.17	QP
4 *	250.3009	54.80	-17.37	37.43	46.00	-8.57	QP
5	432.5455	44.70	-12.16	32.54	46.00	-13.46	QP
6	625.0778	41.40	-7.45	33.95	46.00	-12.05	QP

Note:1).Level (dBuV/m)= Reading (dBuV)+ Factor (dB/m)

2). Factor(dB/m)=Antenna Factor (dB/m) + Cable loss (dB) - Pre Amplifier gain (dB)

3). Margin(dB) = Limit (dBuV/m) - Level (dBuV/m)

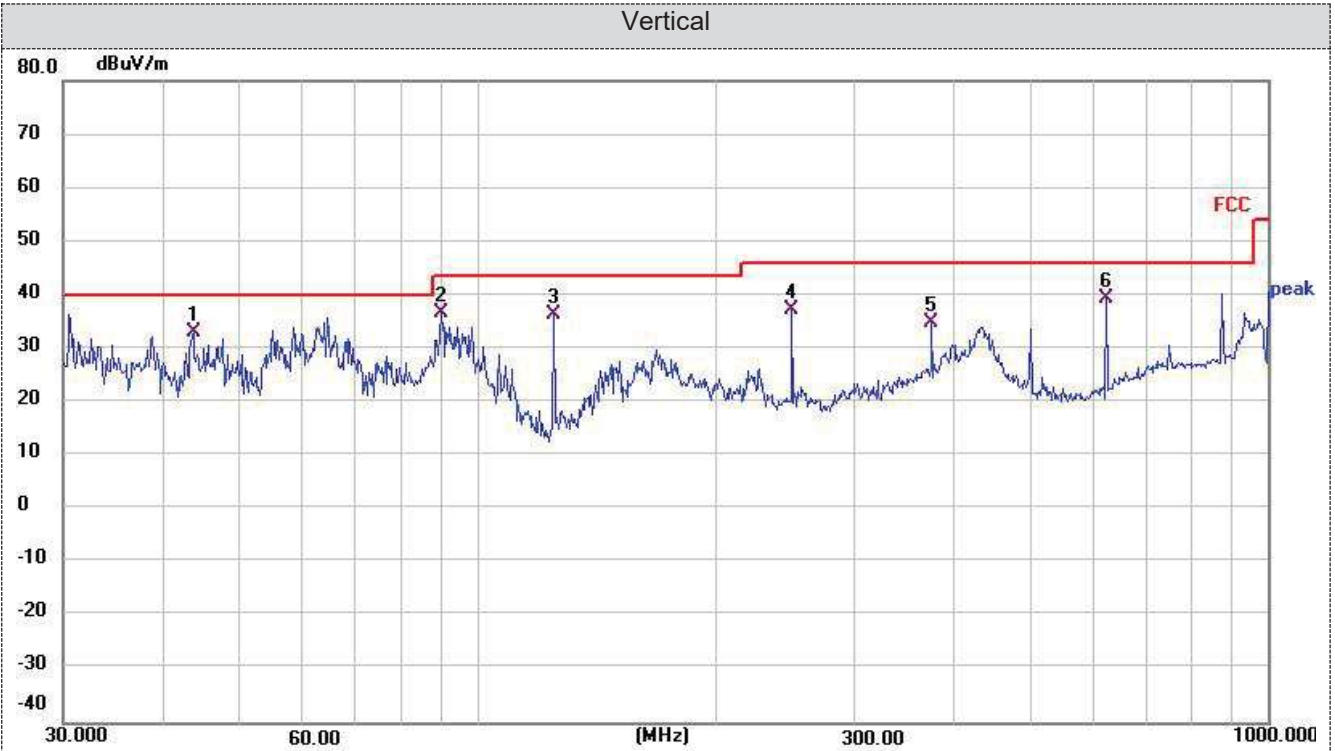

No.	Frequency (MHz)	Reading (dBuV)	Factor (dB/m)	Level (dBuV/m)	Limit (dBuV/m)	Margin (dB)	Detector
1	43.8119	49.50	-16.46	33.04	40.00	-6.96	QP
2	90.2202	57.23	-20.64	36.59	43.50	-6.91	QP
3	125.0065	53.79	-17.56	36.23	43.50	-7.27	QP
4	250.3009	54.51	-17.37	37.14	46.00	-8.86	QP
5	375.9384	48.48	-13.69	34.79	46.00	-11.21	QP
6 *	625.0778	46.77	-7.45	39.32	46.00	-6.68	QP

Note: 1). Level (dBuV/m) = Reading (dBuV) + Factor (dB/m)

2). Factor (dB/m) = Antenna Factor (dB/m) + Cable loss (dB) - Pre Amplifier gain (dB)

3). Margin (dB) = Limit (dBuV/m) - Level (dBuV/m)

For 1GHz to 25GHz

Note: Both ANT 1, 2, 3 and 4 have been test, 802.11b/802.11g/802.11n (H20)/ 802.11n (H40) Mode all have been tested, Only show the worst data of ANT 1 802.11b mode is reported. **(above 1GHz)**

Frequency(MHz):			2412		Polarity:		HORIZONTAL		
Frequency (MHz)	Emission Level (dBuV/m)		Limit (dBuV/m)	Margin (dB)	Raw Value (dBuV)	Antenna Factor (dB/m)	Cable Factor (dB)	Pre-amplifier (dB)	Correction Factor (dB/m)
4824.00	57.09	PK	74	16.91	61.45	32.40	5.11	41.87	-4.36
4824.00	46.53	AV	54	7.47	50.89	32.40	5.11	41.87	-4.36
7236.00	55.11	PK	74	18.89	55.74	36.58	6.43	43.64	-0.63
7236.00	44.58	AV	54	9.42	45.21	36.58	6.43	43.64	-0.63

Frequency(MHz):			2412		Polarity:		VERTICAL		
Frequency (MHz)	Emission Level (dBuV/m)		Limit (dBuV/m)	Margin (dB)	Raw Value (dBuV)	Antenna Factor (dB/m)	Cable Factor (dB)	Pre-amplifier (dB)	Correction Factor (dB/m)
4824.00	56.59	PK	74	17.41	60.95	32.40	5.11	41.87	-4.36
4824.00	46.1	AV	54	7.90	50.46	32.40	5.11	41.87	-4.36
7236.00	55.24	PK	74	18.76	55.87	36.58	6.43	43.64	-0.63
7236.00	44.71	AV	54	9.29	45.34	36.58	6.43	43.64	-0.63

Frequency(MHz):			2437		Polarity:		HORIZONTAL		
Frequency (MHz)	Emission Level (dBuV/m)		Limit (dBuV/m)	Margin (dB)	Raw Value (dBuV)	Antenna Factor (dB/m)	Cable Factor (dB)	Pre-amplifier (dB)	Correction Factor (dB/m)
4874.00	56.92	PK	74	17.08	60.87	32.56	5.34	41.85	-3.95
4874.00	46.50	AV	54	7.50	50.45	32.56	5.34	41.85	-3.95
7311.00	55.18	PK	74	18.82	55.54	36.54	6.81	43.71	-0.36
7311.00	44.85	AV	54	9.15	45.21	36.54	6.81	43.71	-0.36

Frequency(MHz):			2437		Polarity:		VERTICAL		
Frequency (MHz)	Emission Level (dBuV/m)		Limit (dBuV/m)	Margin (dB)	Raw Value (dBuV)	Antenna Factor (dB/m)	Cable Factor (dB)	Pre-amplifier (dB)	Correction Factor (dB/m)
4874.00	56.92	PK	74	17.08	60.87	32.56	5.34	41.85	-3.95
4874.00	46.50	AV	54	7.50	50.45	32.56	5.34	41.85	-3.95
7311.00	55.18	PK	74	18.82	55.54	36.54	6.81	43.71	-0.36
7311.00	44.85	AV	54	9.15	45.21	36.54	6.81	43.71	-0.36

Frequency(MHz):			2462		Polarity:		HORIZONTAL		
Frequency (MHz)	Emission Level (dBuV/m)		Limit (dBuV/m)	Margin (dB)	Raw Value (dBuV)	Antenna Factor (dB/m)	Cable Factor (dB)	Pre-amplifier (dB)	Correction Factor (dB/m)
4924.00	58.39	PK	74	15.61	61.85	32.73	5.64	41.83	-3.46
4924.00	47.96	AV	54	6.04	51.42	32.73	5.64	41.83	-3.46
7386.00	55.79	PK	74	18.21	55.85	36.50	7.23	43.79	-0.06
7386.00	45.26	PK	54	8.74	45.32	36.50	7.23	43.79	-0.06

Frequency(MHz):			2462		Polarity:		VERTICAL		
Frequency (MHz)	Emission Level (dBuV/m)		Limit (dBuV/m)	Margin (dB)	Raw Value (dBuV)	Antenna Factor (dB/m)	Cable Factor (dB)	Pre-amplifier (dB)	Correction Factor (dB/m)
4924.00	57.41	PK	74	16.59	60.87	32.73	5.64	41.83	-3.46
4924.00	47.20	AV	54	6.80	50.66	32.73	5.64	41.83	-3.46
7386.00	55.39	PK	74	18.61	55.45	36.50	7.23	43.79	-0.06
7386.00	45.15	PK	54	8.85	45.21	36.50	7.23	43.79	-0.06

- 1) Emission level (dBuV/m) = Meter Reading+ antenna Factor+ cable loss- preamp factor.
- 2) Margin value = Limits-Emission level.
- 3) -- Mean the PK detector measured value is below average limit.
- 4) The other emission levels were very low against the limit.
- 5) RBW1MHz VBW3MHz Peak detector is for PK value; RBW 1MHz VBW10Hz Peak detector is for AV value.
- 6) The amplitude of spurious emissions which are attenuated by more than 20dB below the permissible value has no need to be reported(18-25G).

Results of Band Edges Test (Radiated)

Note: Both ANT 1, 2, 3 and 4 have been test, 802.11b/802.11g/802.11n (H20)/ 802.11n (H40) Mode all have been tested, Only show the worst data of ANT 1 802.11b mode is reported.

Test Frequency(MHz):			Lowest channel		Polarity:		HORIZONTAL		
Frequency (MHz)	Emission Level (dBuV/m)		Limit (dBuV/m)	Margin (dB)	Raw Value (dBuV)	Antenna Factor (dB/m)	Cable Factor (dB)	Pre-amplifier (dB)	Correction Factor (dB/m)
2390.00	51.35	PK	74	22.65	61.64	27.55	4.35	42.19	-10.29
2390.00	41.56	AV	54	12.44	51.85	27.55	4.35	42.19	-10.29
2400.00	49.49	PK	74	24.51	59.68	27.70	4.39	42.28	-10.19
2400.00	40.28	AV	54	13.72	50.47	27.70	4.39	42.28	-10.19

Test Frequency(MHz):			Lowest channel		Polarity:		VERTICAL		
Frequency (MHz)	Emission Level (dBuV/m)		Limit (dBuV/m)	Margin (dB)	Raw Value (dBuV)	Antenna Factor (dB/m)	Cable Factor (dB)	Pre-amplifier (dB)	Correction Factor (dB/m)
2390.00	49.95	PK	74	24.05	60.24	27.55	4.35	42.19	-10.29
2390.00	39.83	AV	54	14.17	50.12	27.55	4.35	42.19	-10.29
2400.00	49.45	PK	74	24.55	59.64	27.70	4.39	42.28	-10.19
2400.00	38.44	AV	54	15.56	48.63	27.70	4.39	42.28	-10.19

Test Frequency(MHz):			Highest channel		Polarity:		HORIZONTAL		
Frequency (MHz)	Emission Level (dBuV/m)		Limit (dBuV/m)	Margin (dB)	Raw Value (dBuV)	Antenna Factor (dB/m)	Cable Factor (dB)	Pre-amplifier (dB)	Correction Factor (dB/m)
2483.50	49.02	PK	74	24.98	59.65	27.55	4.38	42.56	-10.63
2483.50	39.23	AV	54	14.77	49.86	27.55	4.38	42.56	-10.63
2500.00	46.96	PK	74	27.04	57.69	27.69	4.46	42.88	-10.73
2500.00	37.38	AV	54	16.62	48.11	27.69	4.46	42.88	-10.73

Test Frequency(MHz):			Highest channel		Polarity:		VERTICAL		
Frequency (MHz)	Emission Level (dBuV/m)		Limit (dBuV/m)	Margin (dB)	Raw Value (dBuV)	Antenna Factor (dB/m)	Cable Factor (dB)	Pre-amplifier (dB)	Correction Factor (dB/m)
2483.50	48.00	PK	74	26.00	58.63	27.55	4.38	42.56	-10.63
2483.50	38.22	AV	54	15.78	48.85	27.55	4.38	42.56	-10.63
2500.00	46.90	PK	74	27.10	57.63	27.69	4.46	42.88	-10.73
2500.00	36.13	AV	54	17.87	46.86	27.69	4.46	42.88	-10.73

Note:

- 1) Emission level (dBuV/m) = Meter Reading+ antenna Factor+ cable loss- preamp factor.
- 2) Margin value = Limits-Emission level.
- 3) -- Mean the PK detector measured value is below average limit.
- 4) The other emission levels were very low against the limit.
- 5) RBW1MHz VBW3MHz Peak detector is for PK value; RBW 1MHz VBW10Hz Peak detector is for AV value.

4.3 Maximum Peak Conducted Output Power

Limit

The Maximum Peak Output Power Measurement is 30dBm.

Test Procedure

Remove the antenna from the EUT and then connect a low loss RF cable from the antenna port to the power sensor.

Test Configuration



Test Results

Type	Channel	Output power PK ANT 1 (dBm)	Output power PK ANT 2 (dBm)	Output power PK ANT 3 (dBm)	Output power PK ANT 4 (dBm)	Total Power PK ANT 1+2+3+4 (dBm)	Limit (dBm)	Result
802.11b	01	15.656	14.619	13.062	11.424	/	30	Pass
	06	14.881	13.112	12.254	10.709	/		
	11	13.894	12.658	11.354	9.862	/		
802.11g	01	15.103	14.025	13.121	11.254	/	30	Pass
	06	14.756	13.546	12.746	10.621	/		
	11	14.097	13.321	12.145	10.856	/		
802.11n (HT20)	01	14.956	13.652	12.235	10.635	19.180	28.83	Pass
	06	14.562	12.653	11.695	9.951	18.553		
	11	14.194	12.983	11.235	9.421	18.337		
802.11n (HT40)	03	12.574	10.568	9.625	7.541	16.467	28.83	Pass
	06	12.123	11.236	9.568	7.125	16.416		
	09	11.906	9.856	8.123	6.546	15.586		

Note:

- 1) Measured output power at difference data rate for each mode and recorded worst case for each mode.
- 2) Test results including cable loss.
- 3) Worst case data at 1Mbps at IEEE 802.11b; 6Mbps at IEEE 802.11g; 6.5Mbps at IEEE 802.11n HT20; 13.5Mbps at IEEE 802.11n HT40;

Type	Channel	Output power AV ANT 1 (dBm)	Output power AV ANT 2 (dBm)	Output power AV ANT 3 (dBm)	Output power AV ANT 4 (dBm)	Total Power AV ANT 1+2+3+4	Limit (dBm)	Result
802.11b	01	11.562	10.322	9.211	7.245	/	30	Pass
	06	10.321	9.654	8.245	7.362	/		
	11	9.654	8.265	7.121	6.213	/		
802.11g	01	10.426	9.654	8.123	6.542	/	30	Pass
	06	10.352	8.965	7.256	6.111	/		
	11	10.124	9.235	8.124	6.854	/		
802.11n (HT20)	01	10.562	9.263	7.842	5.652	14.710	28.83	Pass
	06	10.234	9.132	7.456	5.632	14.466		
	11	10.025	8.654	6.874	4.851	14.034		
802.11n (HT40)	03	8.695	7.235	6.123	4.521	12.928	28.83	Pass
	06	8.421	7.325	6.452	4.623	12.938		
	09	7.362	6.325	5.635	3.856	11.994		

Note:

- 1) Measured output power at difference data rate for each mode and recorded worst case for each mode.
- 2) Test results including cable loss.
- 3) Worst case data at 1Mbps at IEEE 802.11b; 6Mbps at IEEE 802.11g; 6.5Mbps at IEEE 802.11n HT20; 13.5Mbps at IEEE 802.11n HT40;

4.4 Power Spectral Density

Limit

For digitally modulated systems, the power spectral density conducted from the intentional radiator to the antenna shall not be greater than 8 dBm in any 3 kHz band during any time interval of continuous transmission.

Test Procedure

1. Use this procedure when the maximum peak conducted output power in the fundamental emission is used to demonstrate compliance.
2. Set the RBW \geq 3 kHz.
3. Set the VBW \geq 3 \times RBW.
4. Set the span to 1.5 times the DTS channel bandwidth.
5. Detector = peak.
6. Sweep time = auto couple.
7. Trace mode = max hold.
8. Allow trace to fully stabilize.
9. Use the peak marker function to determine the maximum power level.
10. If measured value exceeds limit, reduce RBW (no less than 3 kHz) and repeat.
11. The resulting peak PSD level must be 8dBm.

Test Configuration



Test Results

Type	Channel	Power Spectral Density (dBm/3KHz)					Limit (dBm/3 KHz)	Result
		ANT 1	ANT 2	ANT 3	ANT 4	Total ANT 1+2+3+4		
802.11b	01	-15.806	-19.155	-22.268	-25.822	/	8	Pass
	06	-16.399	-19.982	-22.337	-26.523	/		
	11	-16.458	-20.746	-22.343	-26.350	/		
802.11g	01	-16.023	-19.662	-24.135	-27.579	/	8	Pass
	06	-16.117	-20.444	-21.683	-27.580	/		
	11	-16.641	-21.031	-23.154	-27.226	/		
802.11n (HT20)	01	-17.355	-20.895	-24.362	-28.218	-14.990	6.83	Pass
	06	-15.599	-19.293	-20.941	-26.367	-13.038		
	11	-16.512	-20.416	-22.840	-27.840	-14.173		
802.11n (HT40)	03	-20.928	-23.967	-26.113	-29.615	-18.061	6.83	Pass
	06	-19.016	-23.502	-25.880	-29.371	-16.831		
	09	-20.555	-23.616	-28.098	-29.961	-18.039		

Note:

- 1) Measured peak power spectrum density at difference data rate for each mode and recorded worst case for each mode.
- 2) Test results including cable loss;
- 3) Worst case data at 1Mbps at IEEE 802.11b; 6Mbps at IEEE 802.11g; 6.5Mbps at IEEE 802.11n HT20; 13.5Mbps at IEEE 802.11n HT40;

Please refer to following plots;

ANT 1

802.11b



802.11g



CH01



CH01

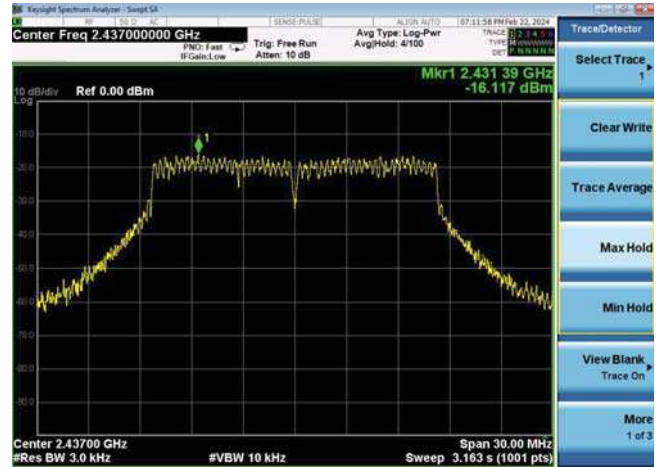

CH06



CH06



CH11

CH11

802.11n(HT20)

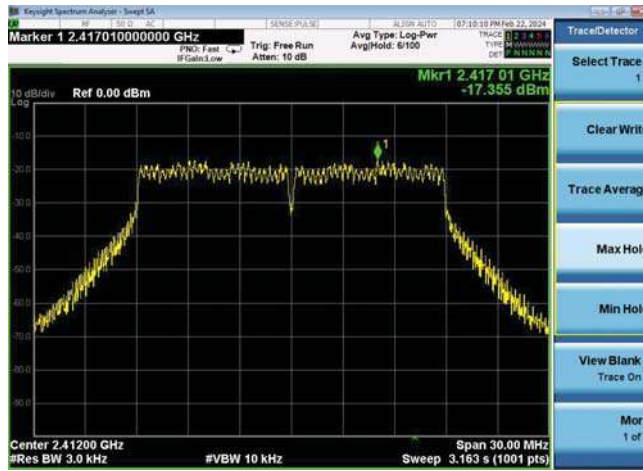

802.11n(HT40)



CH01



CH03



CH06

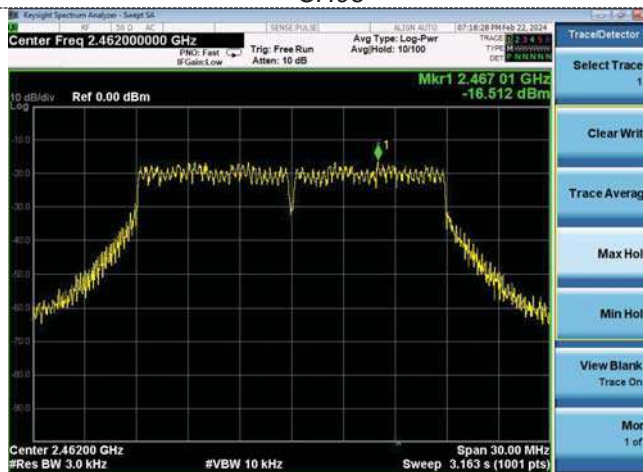

CH06

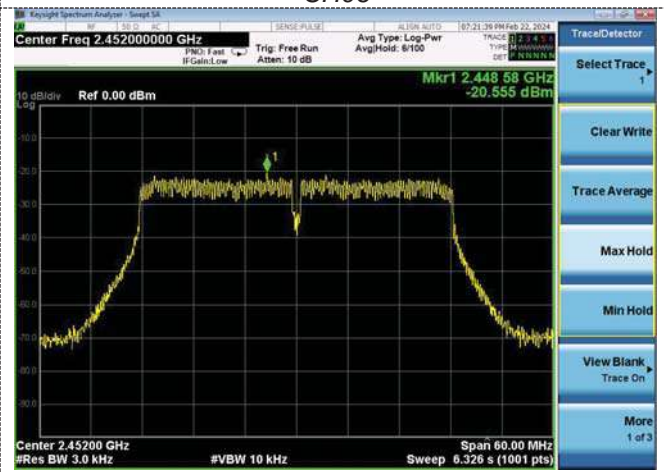

CH11

CH09

ANT 2

802.11b



802.11g

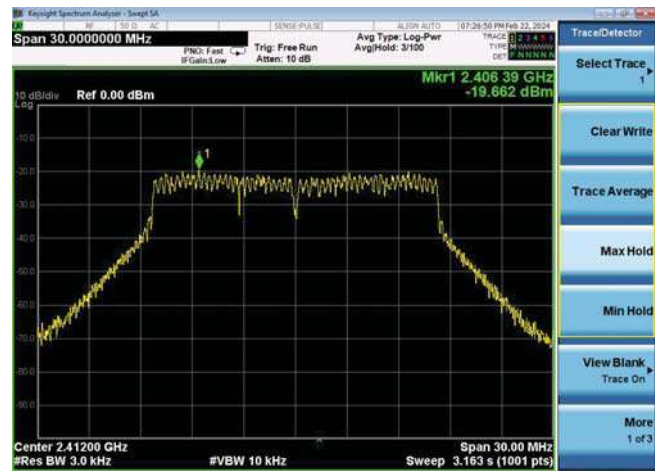

CH01



CH01

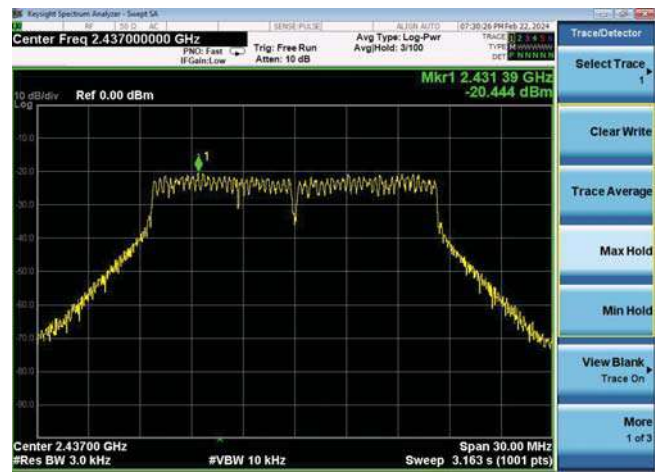

CH06



CH06

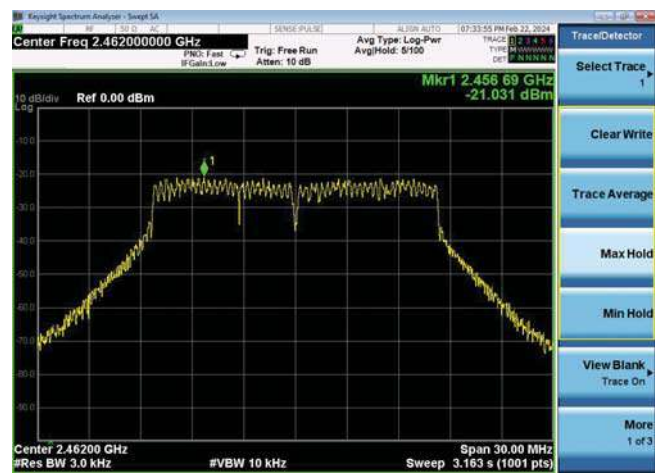

CH11



CH11



802.11n(HT20)

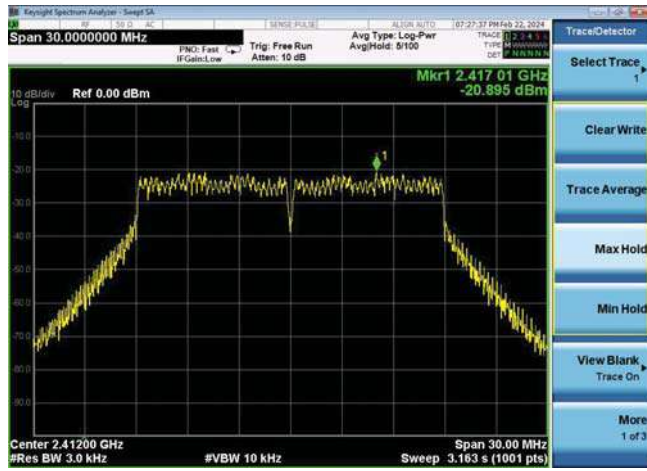

802.11n(HT40)

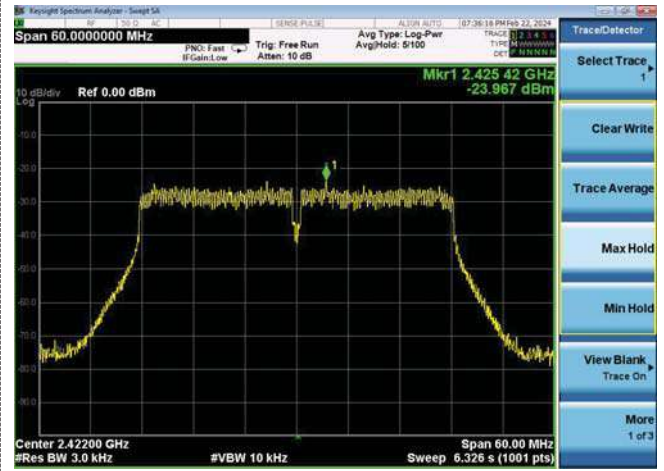

CH01

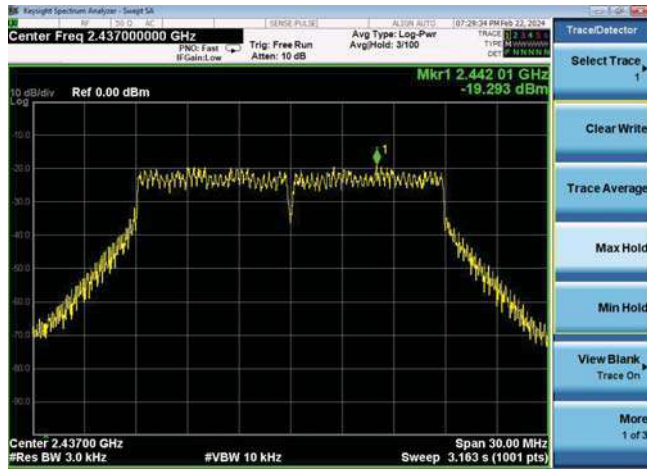

CH03



CH06



CH06



CH11

CH09

ANT 3

802.11b



802.11g

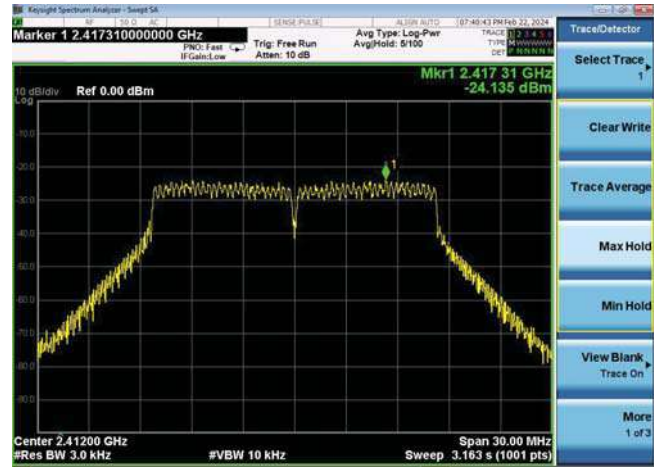

CH01



CH01

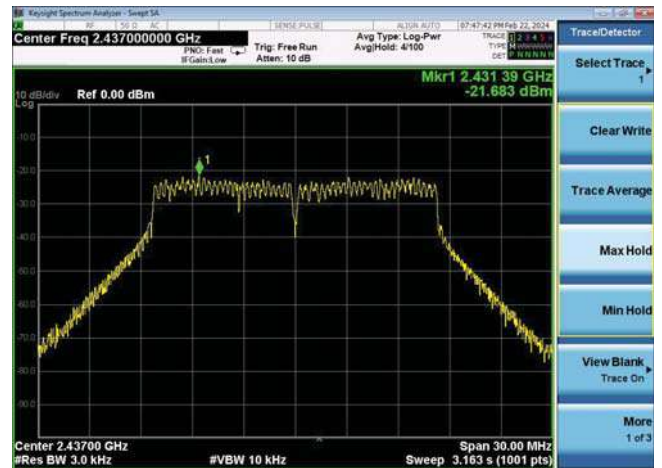

CH06



CH06

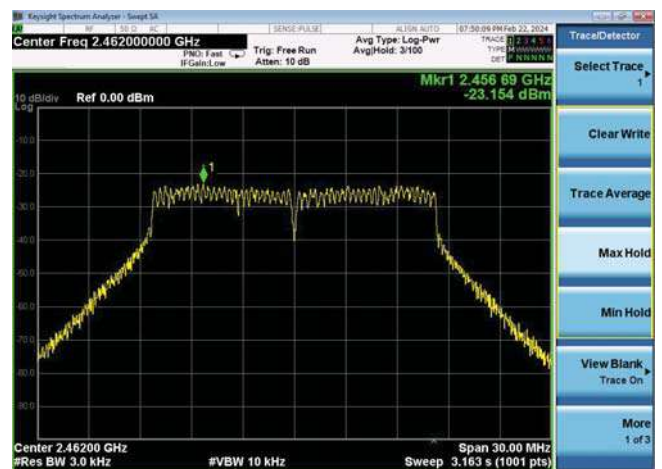

CH11



CH11

802.11n(HT20)

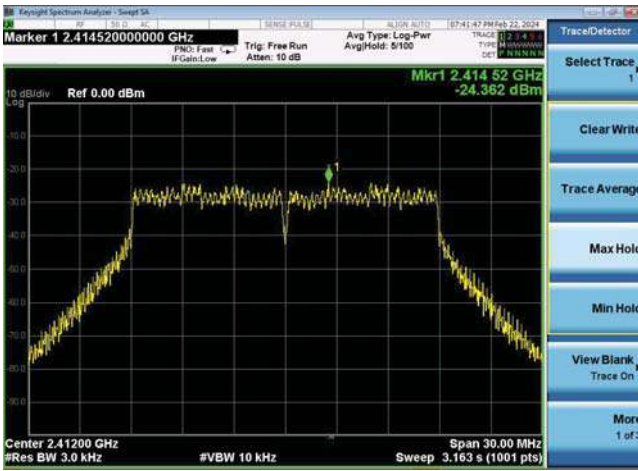

802.11n(HT40)

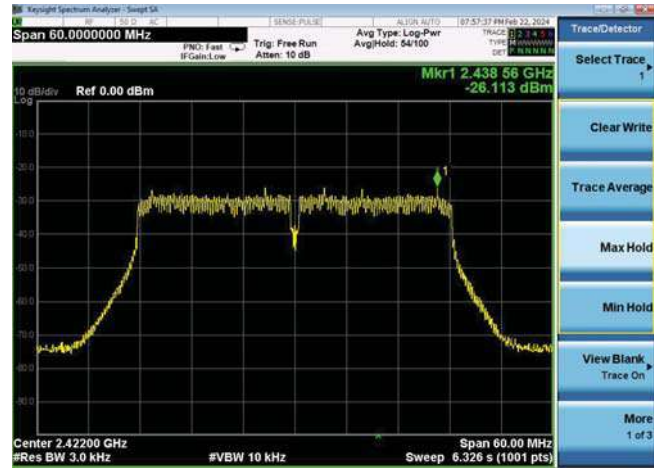

CH01



CH03



CH06

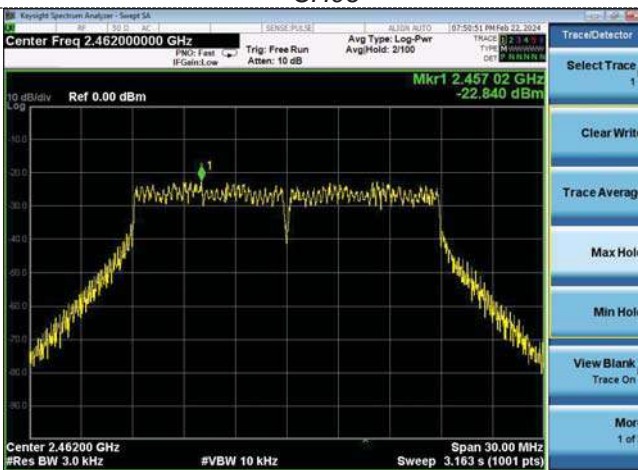

CH06



CH11

CH09

ANT 4

802.11b



802.11g



CH01



CH01



CH06



CH06

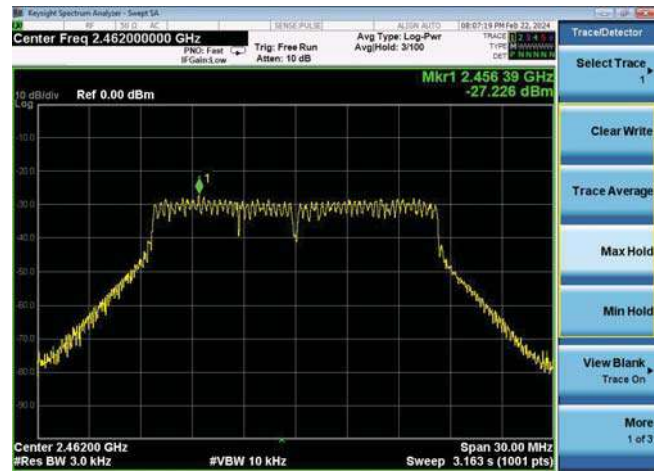

CH11

CH11

802.11n(HT20)

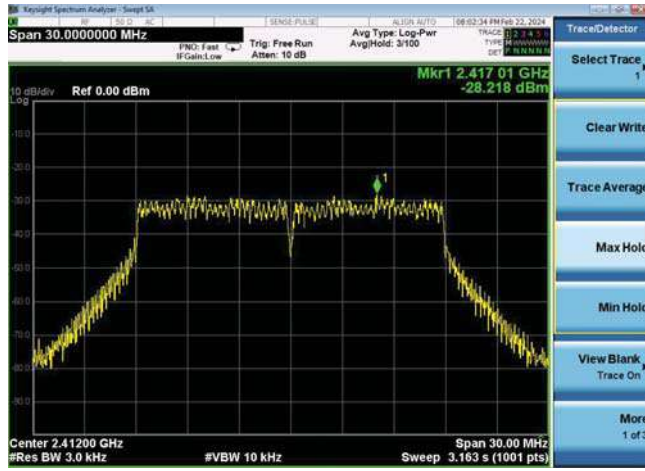

802.11n(HT40)



CH01



CH03



CH06

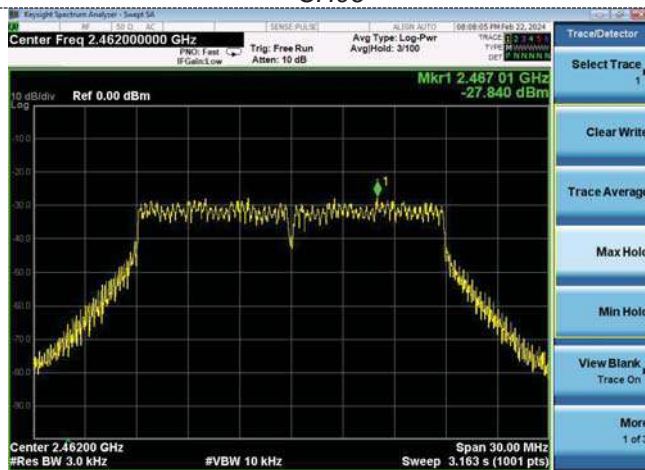

CH06

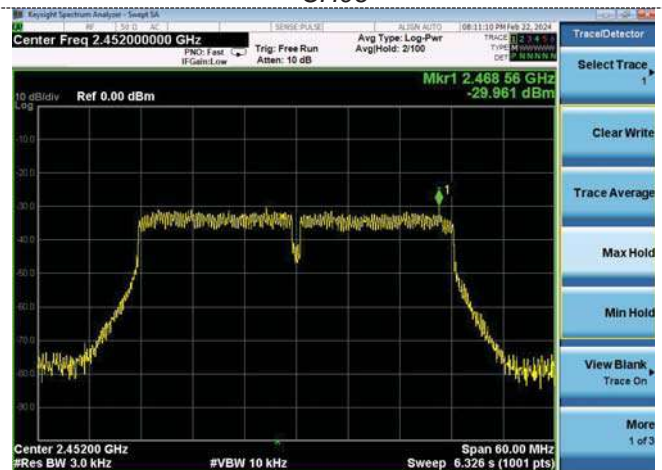

CH11

CH09

4.5 6dB Bandwidth

Limit

For digital modulation systems, the minimum 6 dB bandwidth shall be at least 500 kHz

Test Procedure

The transmitter output was connected to the spectrum analyzer through an attenuator. The bandwidth of the fundamental frequency was measured by spectrum analyzer with 100 KHz RBW and 300 KHz VBW. The 6dB bandwidth is defined as the total spectrum the power of which is higher than peak power minus 6dB.

Test Configuration



Test Results

Type	Channel	6dB Bandwidth (MHz)				Limit (KHz)	Result
		ANT 1	ANT 2	ANT 3	ANT 4		
802.11b	01	14.15	14.05	13.02	12.05	≥500	Pass
	06	14.12	13.55	12.73	11.08		
	11	13.60	13.07	12.11	11.08		
802.11g	01	16.54	16.53	16.52	16.52	≥500	Pass
	06	16.53	16.53	16.52	16.52		
	11	16.54	16.50	16.52	16.52		
802.11n (HT20)	01	17.80	17.75	17.74	17.74	≥500	Pass
	06	17.79	17.74	17.72	17.70		
	11	17.76	17.74	17.72	17.72		
802.11n (HT40)	03	36.48	36.47	36.48	36.48	≥500	Pass
	06	36.47	36.48	36.48	36.49		
	09	36.46	36.47	36.47	36.47		

Note:

- 1) Measured peak power spectrum density at difference data rate for each mode and recorded worst case for each mode.
 - 2) Test results including cable loss;
 - 3) Worst case data at 1Mbps at IEEE 802.11b; 6Mbps at IEEE 802.11g; 6.5Mbps at IEEE 802.11n HT20; 13.5Mbps at IEEE 802.11n HT40;
- Please refer to following plots;

ANT 1

802.11b



802.11g

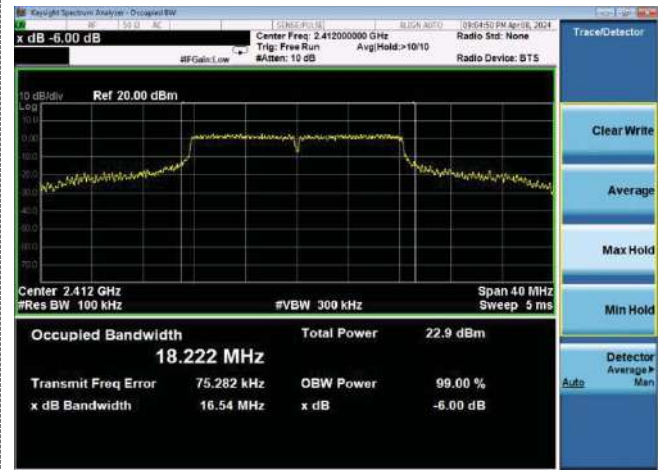

CH01



CH01

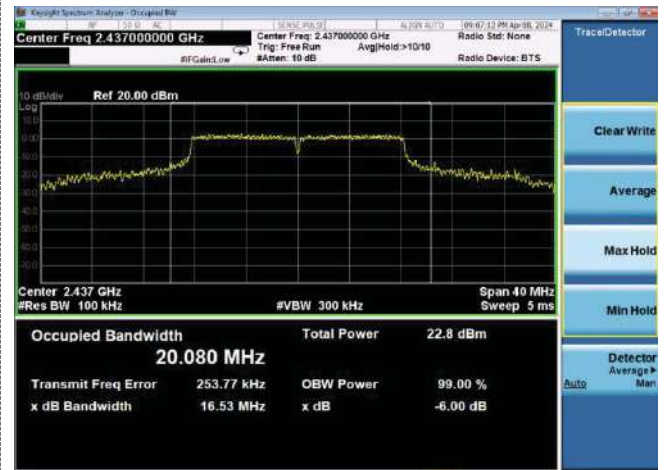

CH06

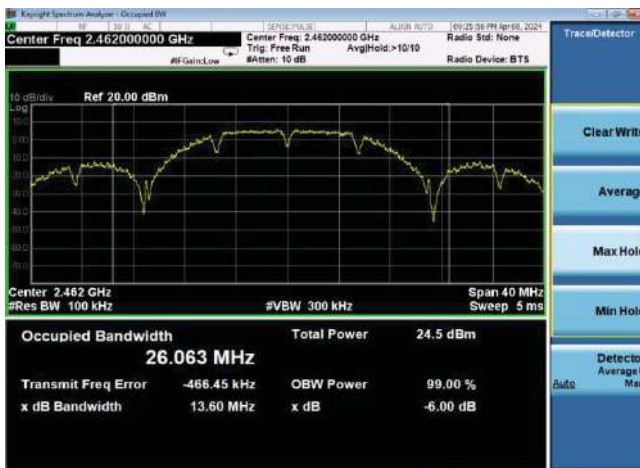

CH06

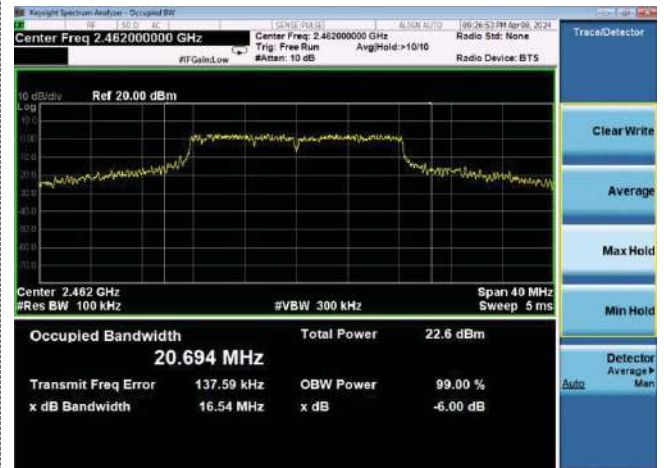

CH11



CH11



802.11n(HT20)

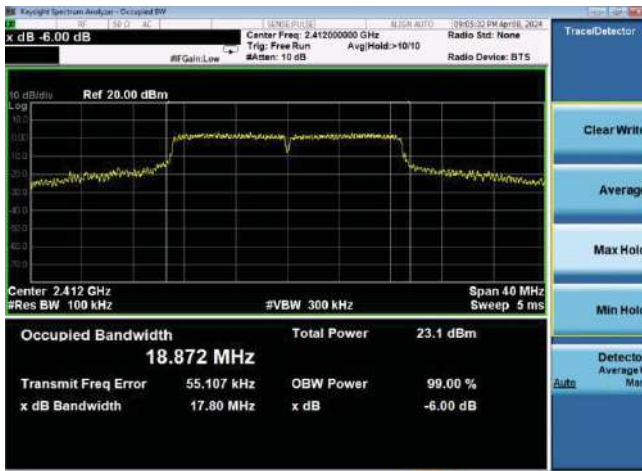

802.11n(HT40)

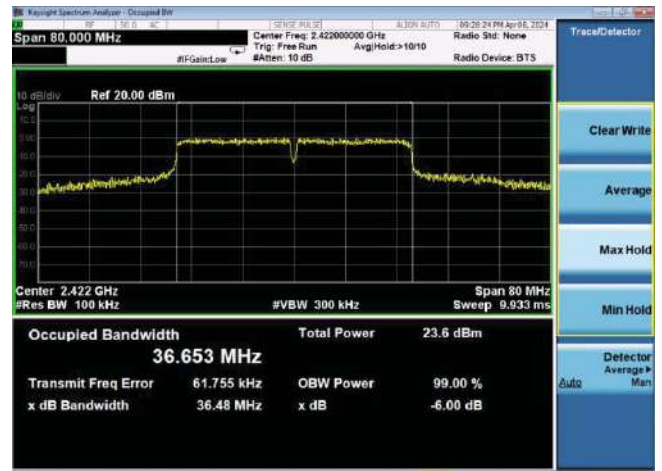

CH01

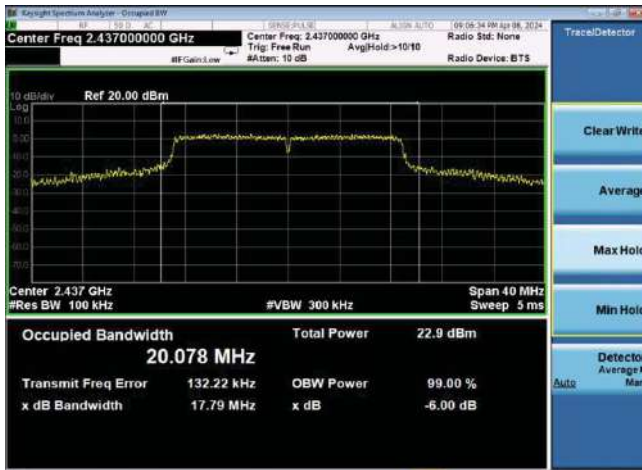

CH03

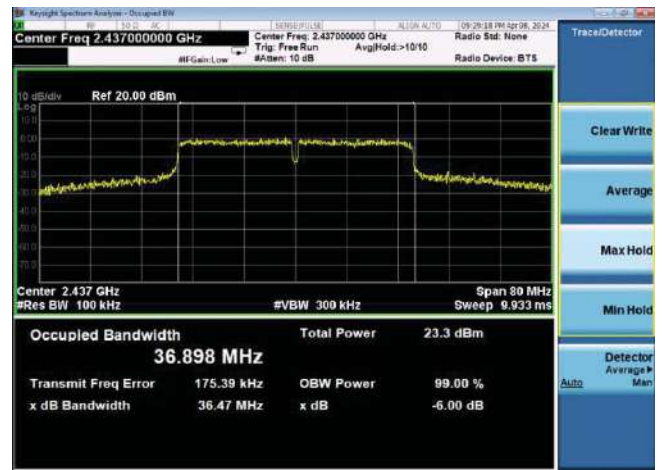

CH06



CH06

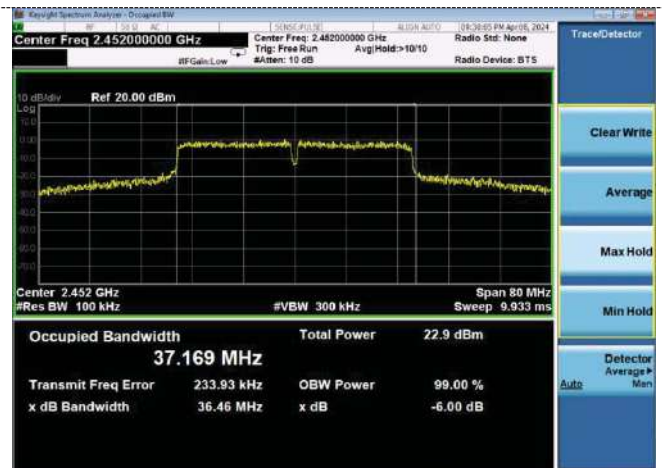

CH11

CH09

ANT 2

802.11b

802.11g

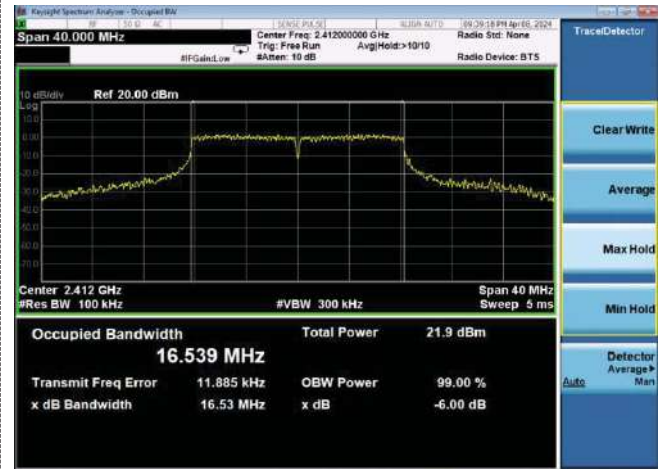
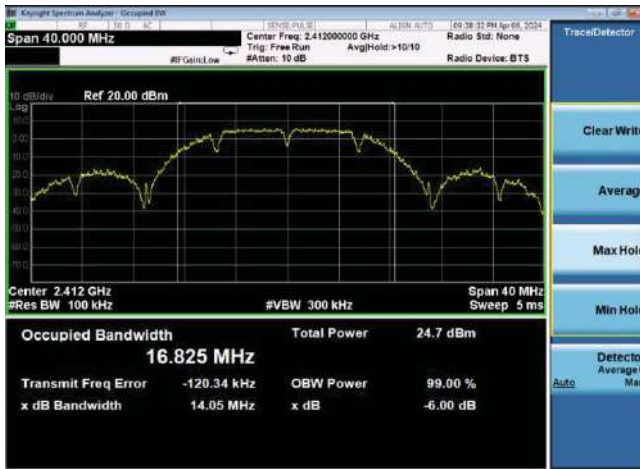

CH01

CH01

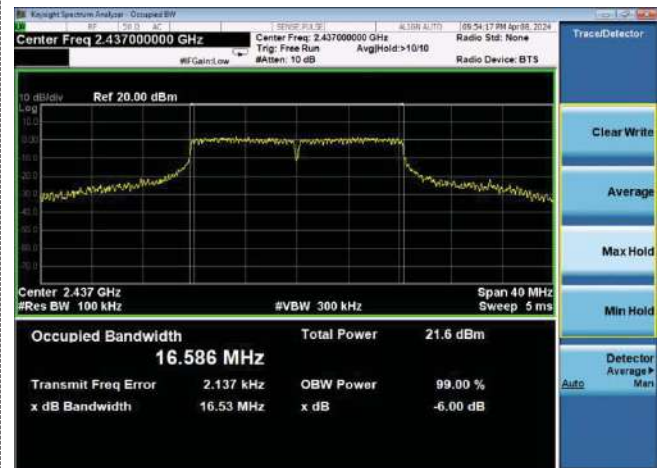
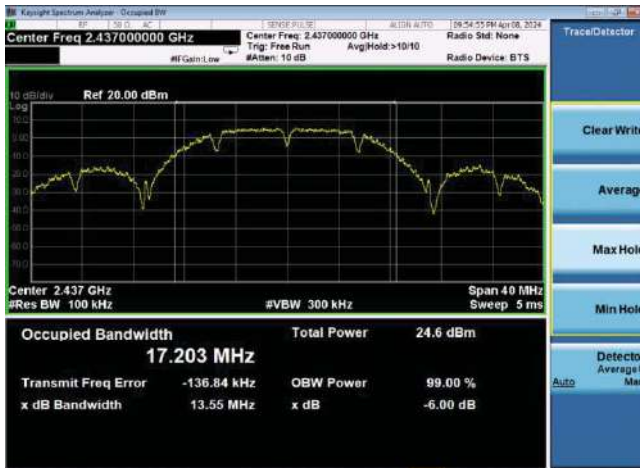

CH06

CH06

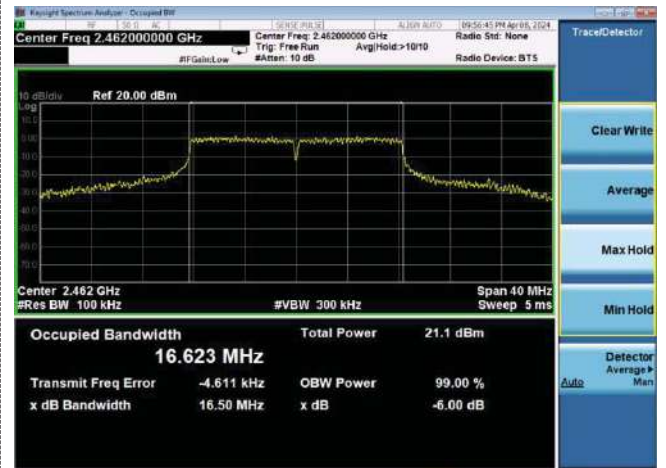
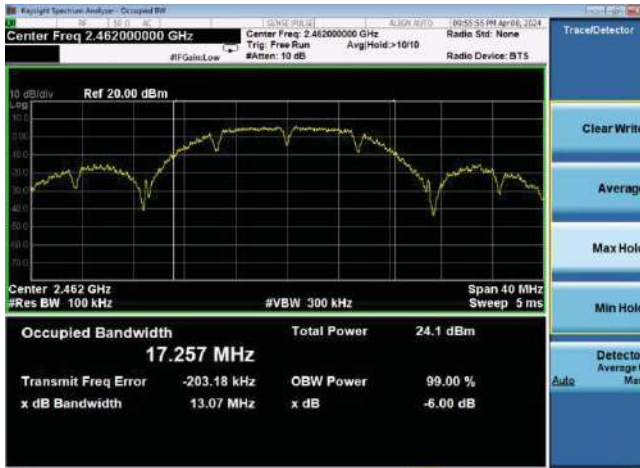

CH11

CH11

802.11n(HT20)

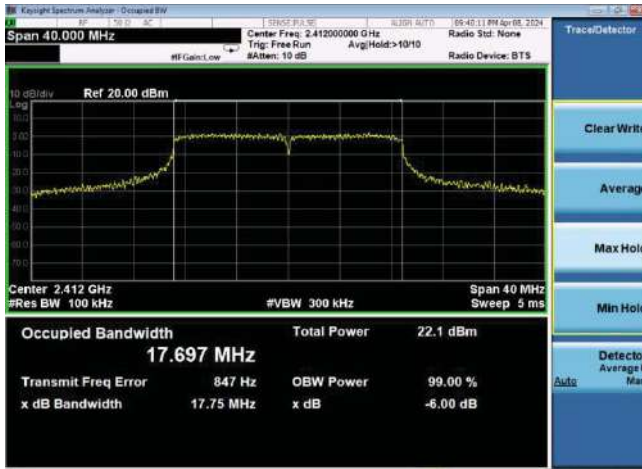

802.11n(HT40)

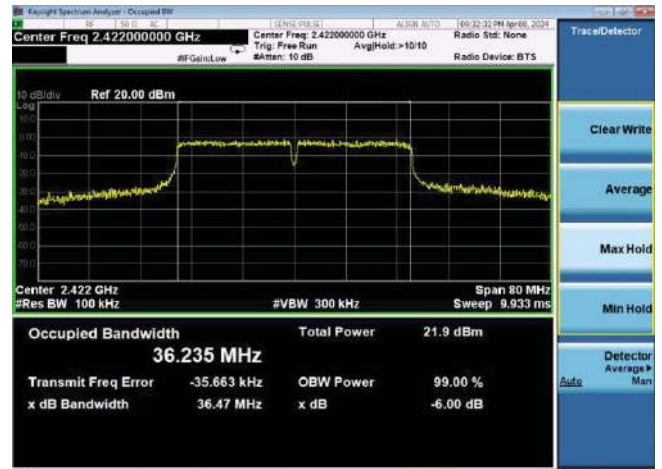

CH01

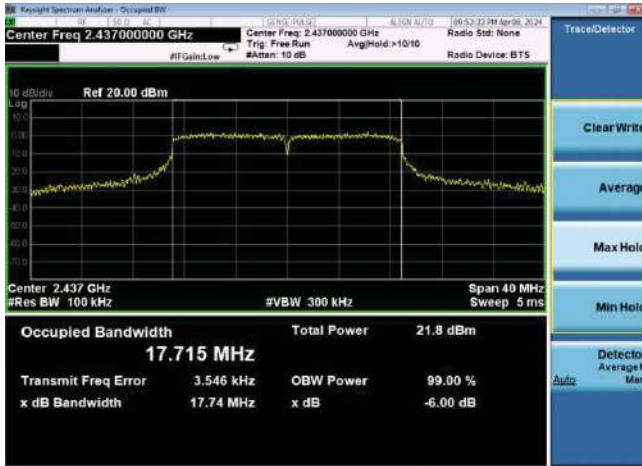

CH03

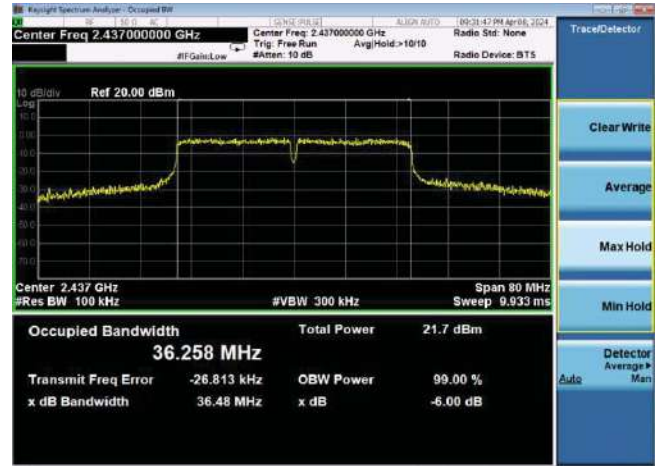

CH06

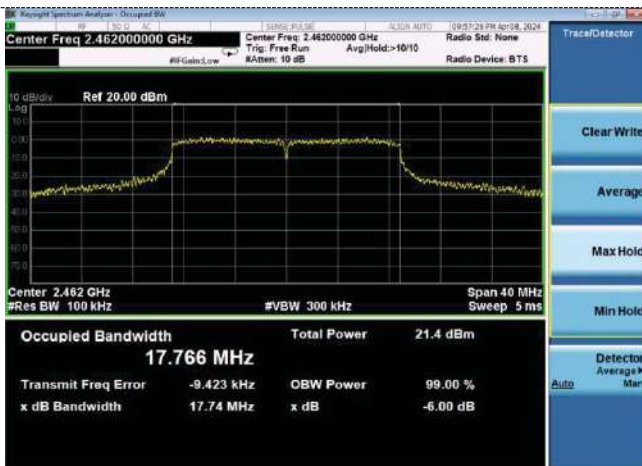

CH06

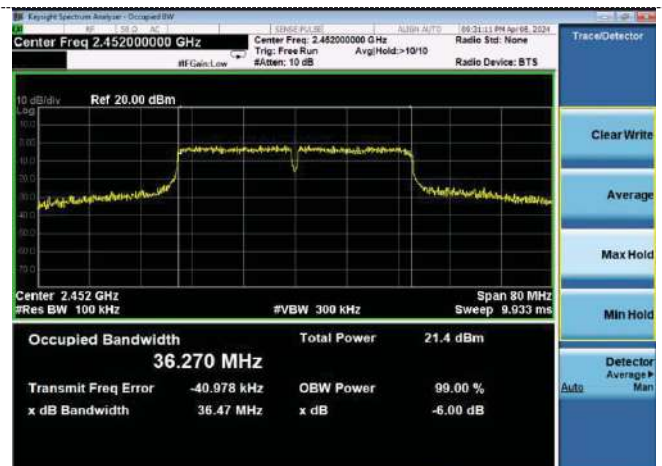

CH11

CH09

ANT 3

802.11b

802.11g

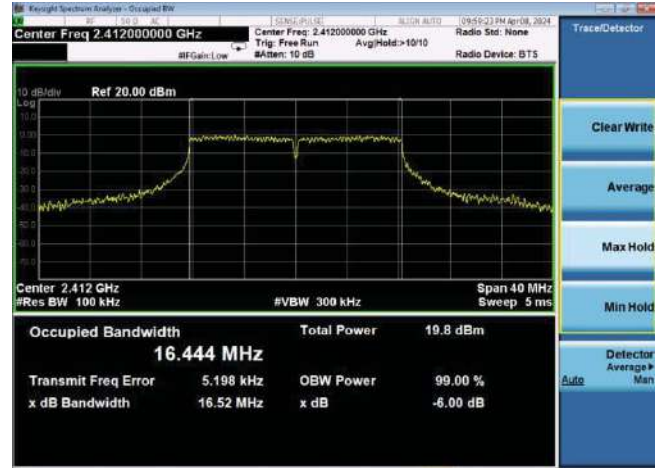

CH01

CH01

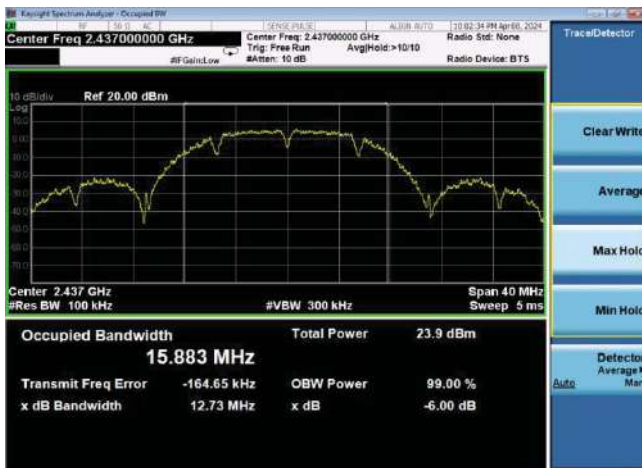

CH06

CH06

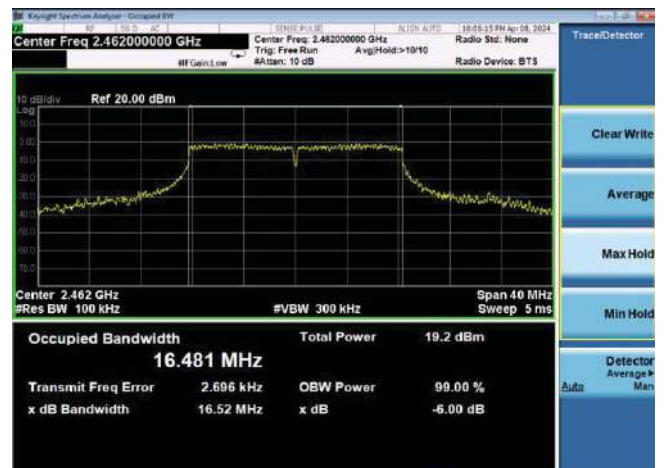

CH11

CH11

802.11n(HT20)

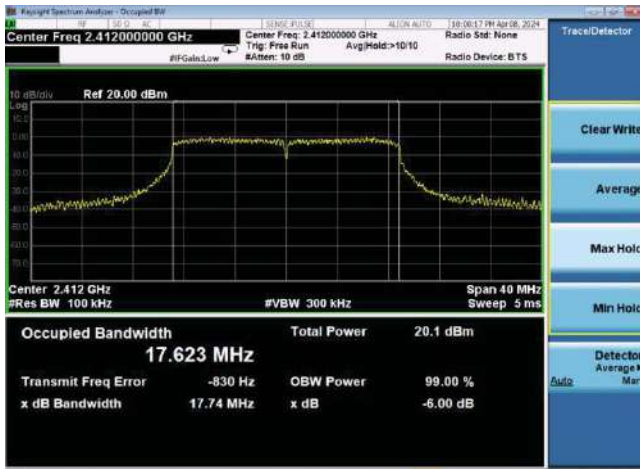

802.11n(HT40)

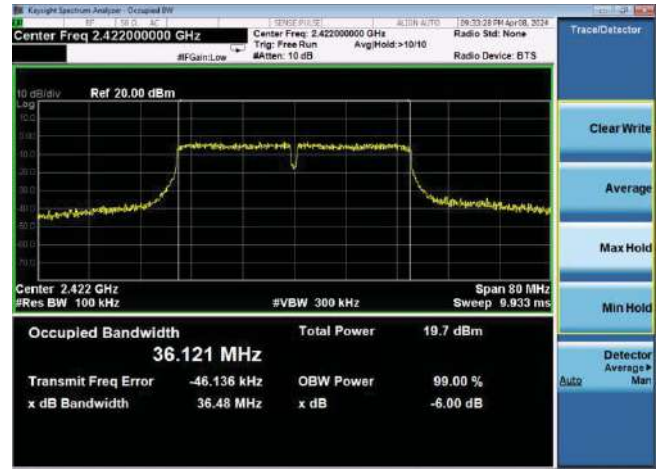

CH01

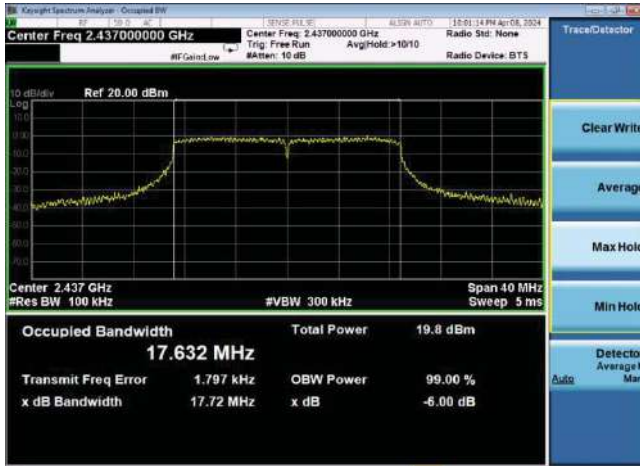

CH03

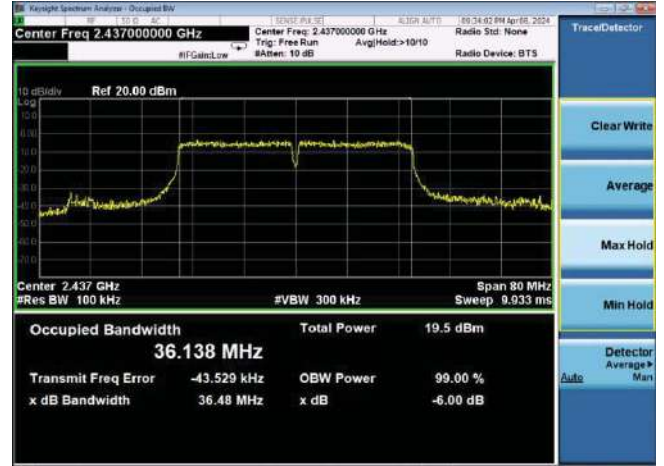

CH06

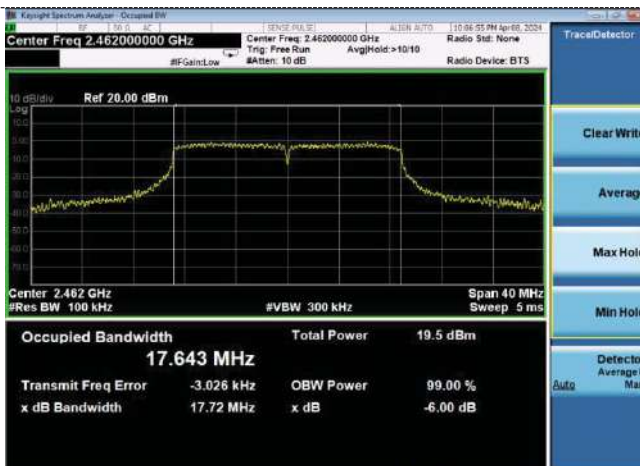

CH06



CH11

CH09

ANT 4

802.11b



802.11g

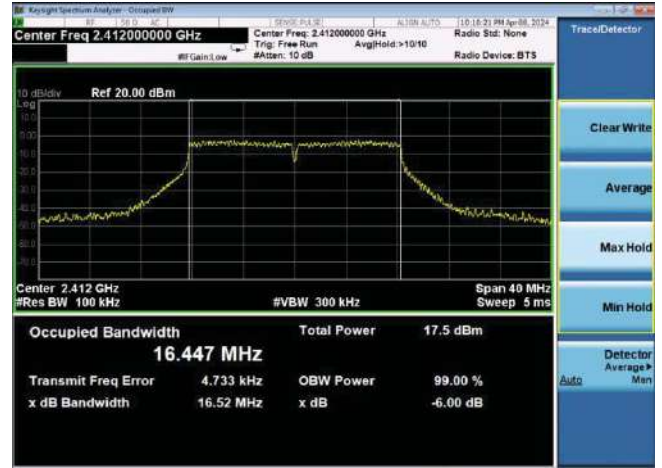

CH01

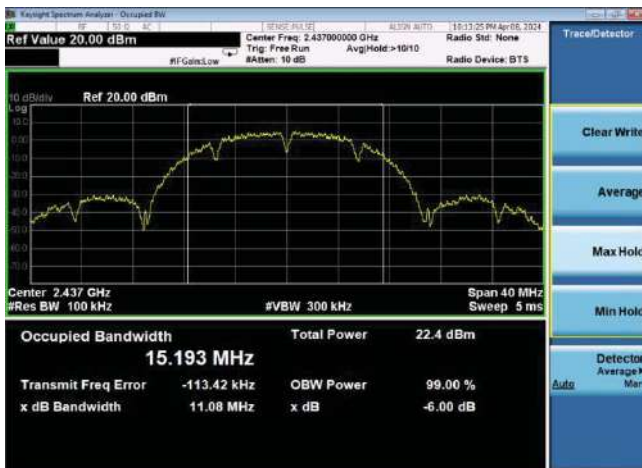

CH01

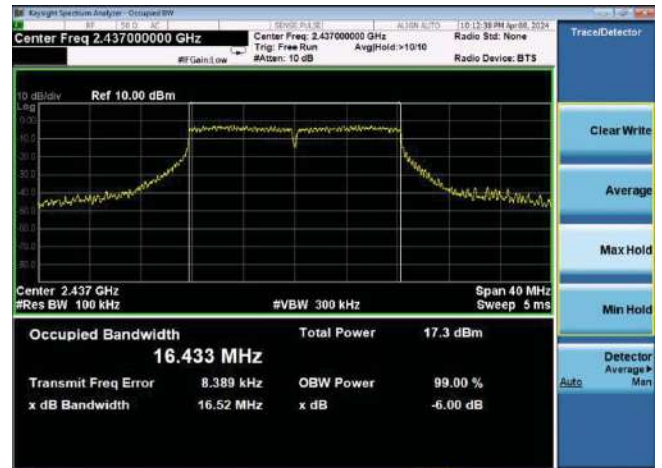

CH06



CH06

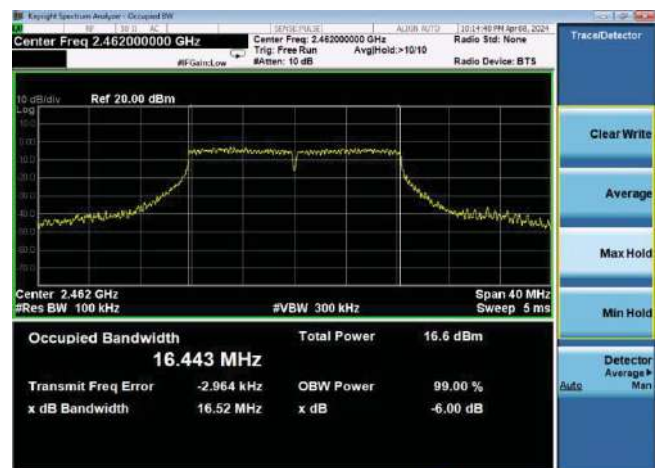

CH11



CH11



802.11n(HT20)

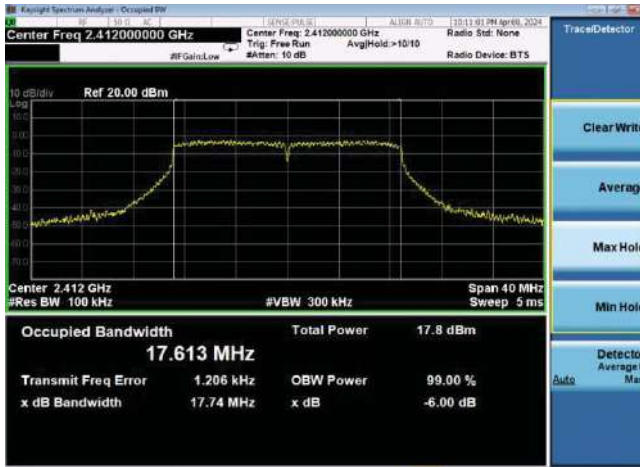

802.11n(HT40)

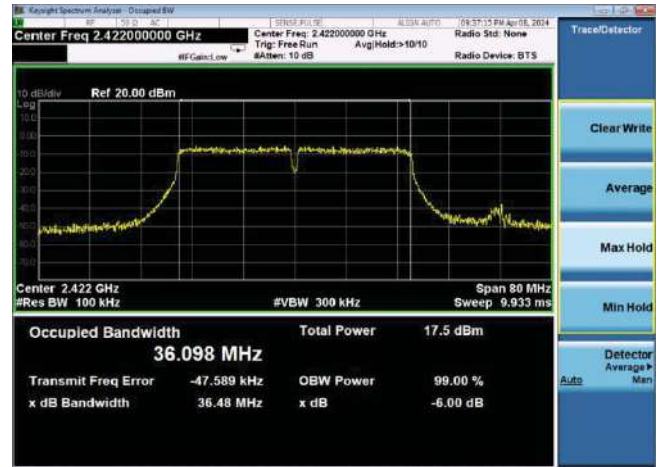

CH01

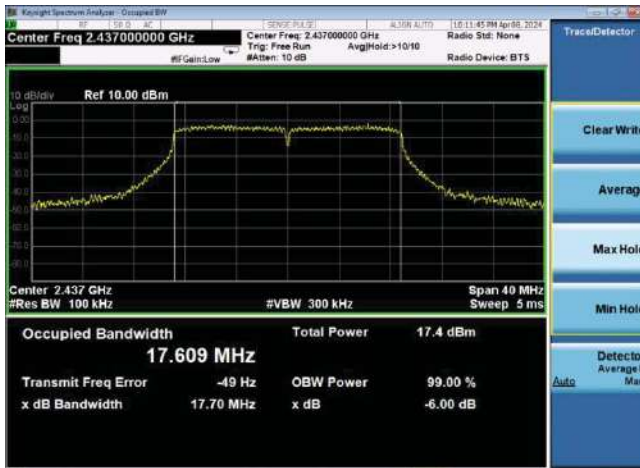

CH03

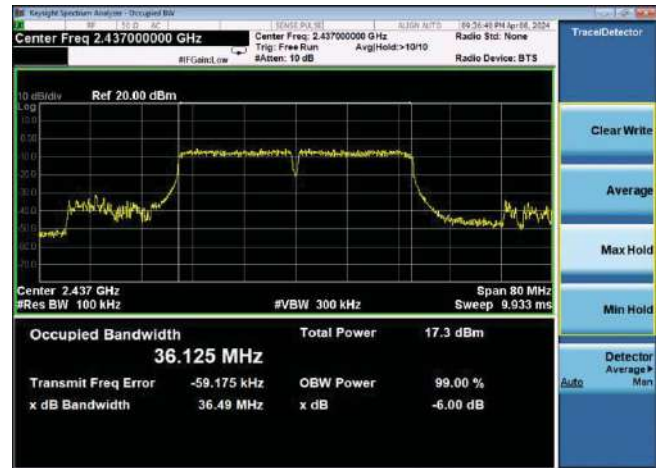

CH06



CH06

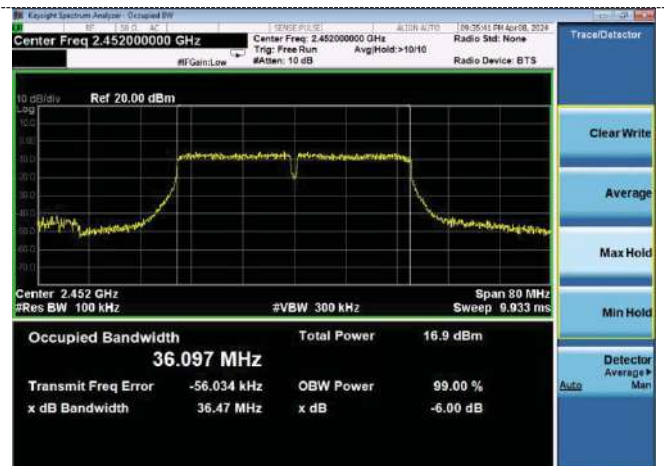

CH11

CH09

4.6 Out-of-band Emissions

Limit

In any 100 kHz bandwidth outside the frequency band in which the spread spectrum or digitally modulated intentional radiator is operating, the radio frequency power that is produced by the intentional radiator shall be at least 20 dB below that in the 100 kHz bandwidth within the band that contains the highest level of the desired power, based on either an RF conducted or a radiated measurement, provided the transmitter demonstrates compliance with the peak conducted power limits. If the transmitter complies with the conducted power limits based on the use of RMS averaging over a time interval, as permitted under paragraph (b)(3) of this section, the attenuation required under this paragraph shall be 30 dB instead of 20 dB. Attenuation below the general limits specified in §15.209(a) is not required.

Test Procedure

Connect the transmitter output to spectrum analyzer using a low loss RF cable, and set the spectrum analyzer to RBW=100 kHz, VBW= 300 kHz, peak detector, and max hold. Measurements utilizing these settings are made of the in-band reference level, bandedge and out-of-band emissions.

Test Configuration



Test Results

Remark: The measurement frequency range is from 30MHz to the 10th harmonic of the fundamental frequency. The lowest, middle and highest channels are tested to verify the spurious emissions and bandedge measurement data. And record the worst data in the report.

Test plot as follows:

Note: ANT 1 Power > ANT 2 Power > ANT 3 Power > ANT 4 Power, Both ANT 1, 2, 3 and 4 have been test, Only show the worst data of ANT 1.

802.11b

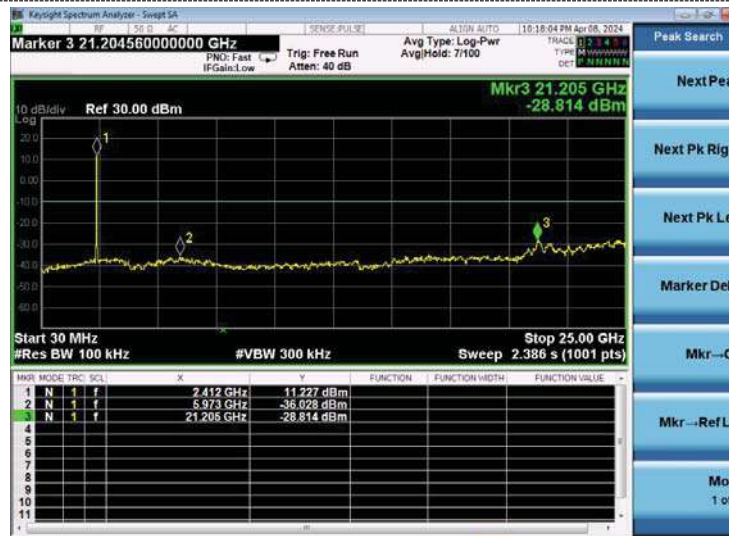

CH01

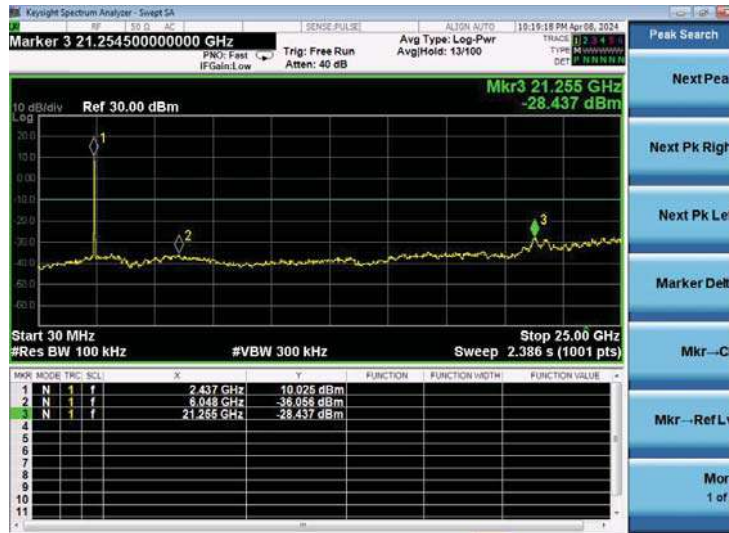

CH06

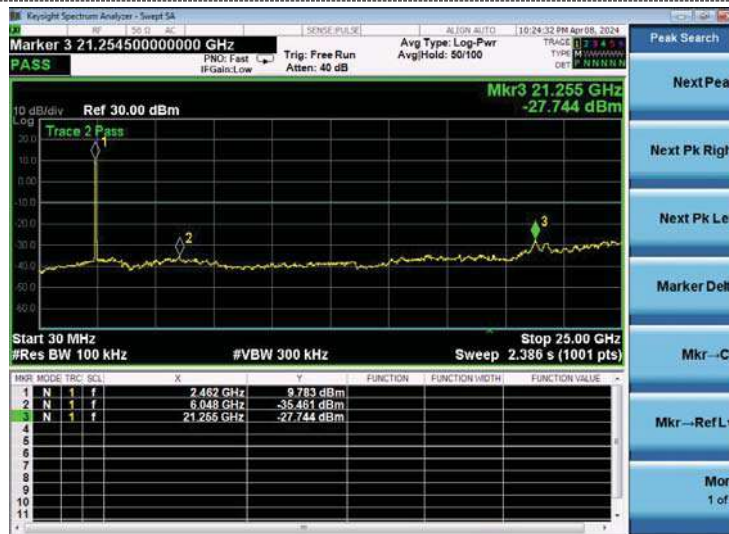

CH011

802.11g

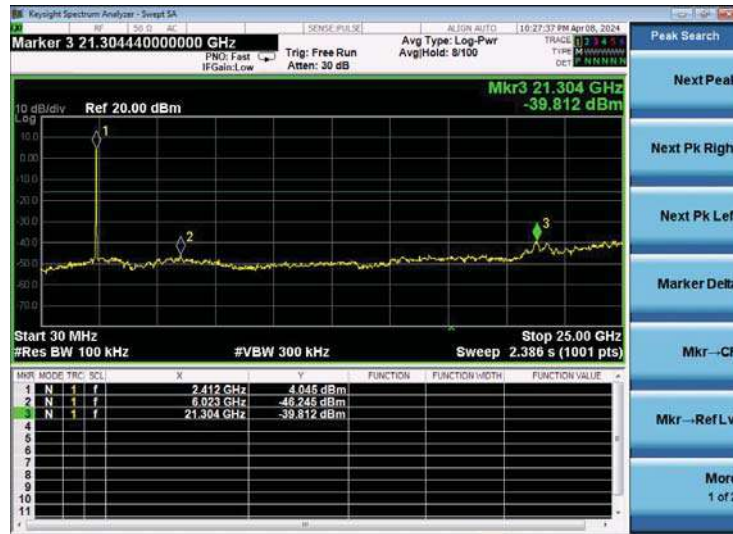

CH01

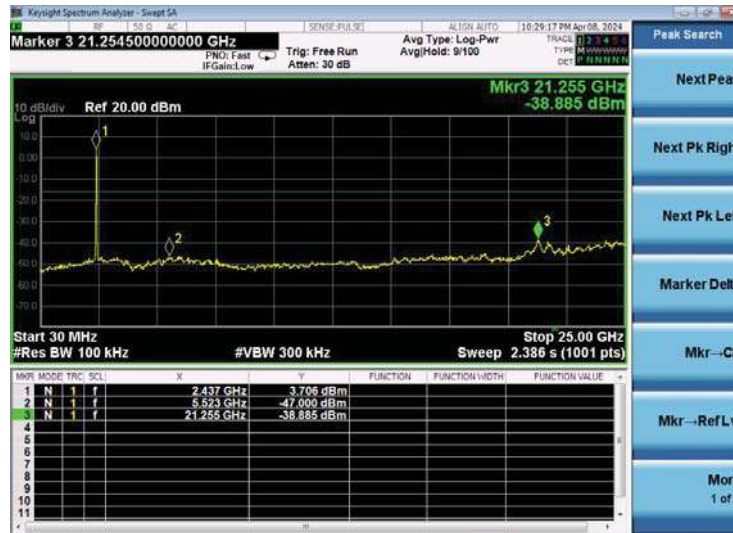

CH06

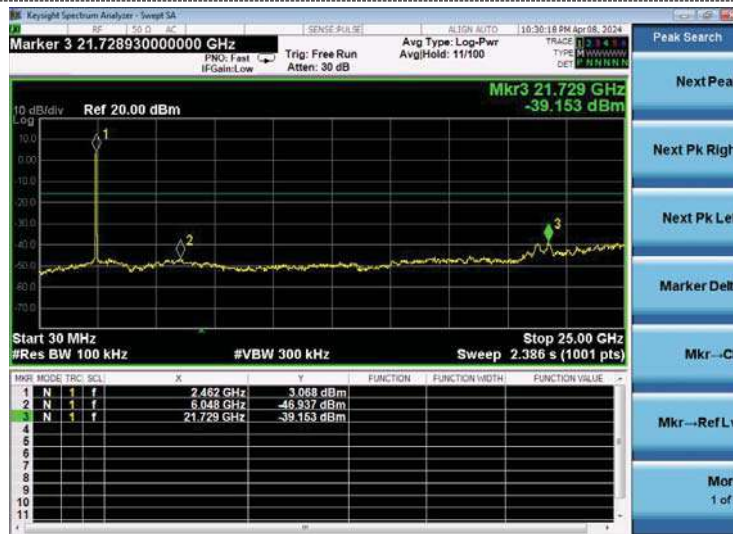

CH011

802.11n20

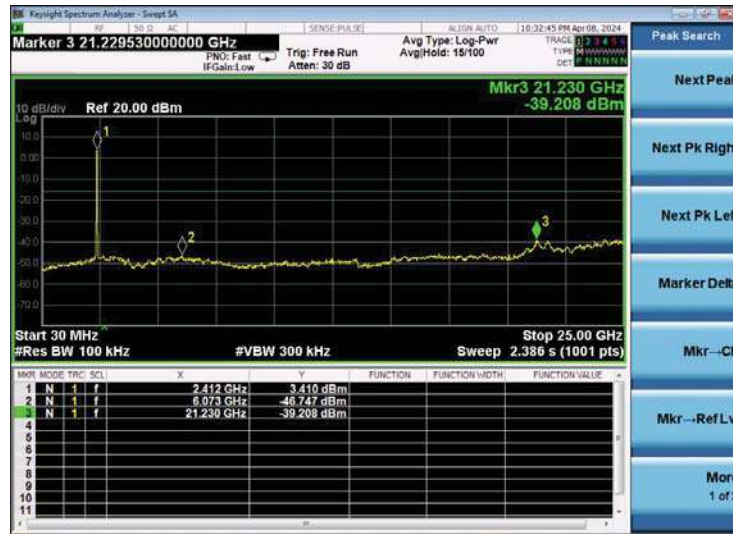

CH01

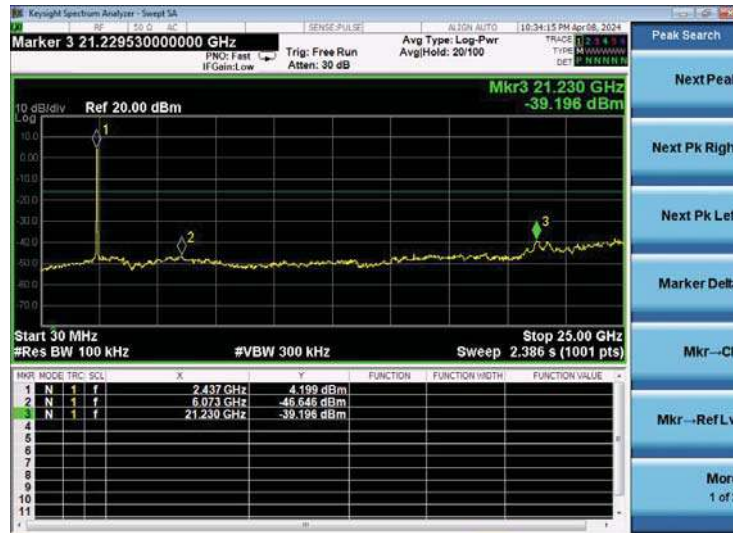

CH06

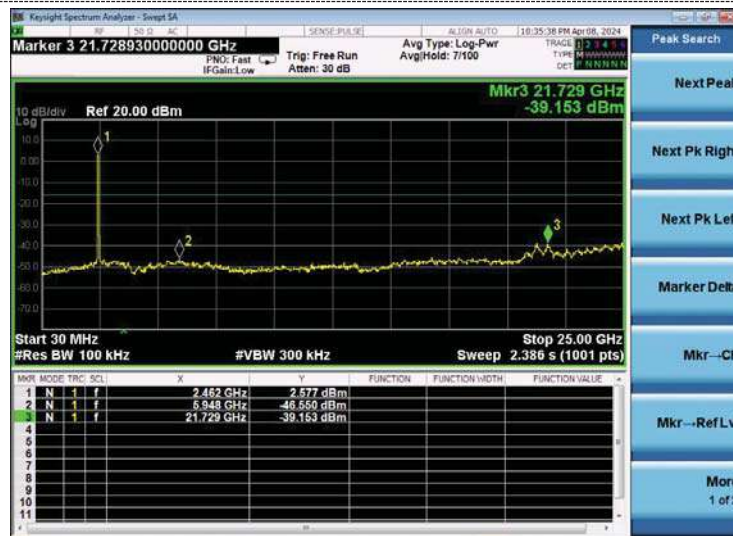

CH011

802.11n40

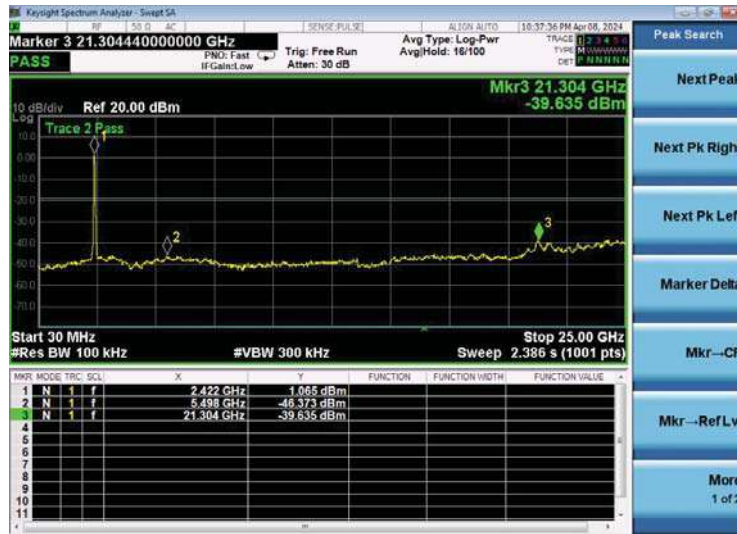

CH03



CH06

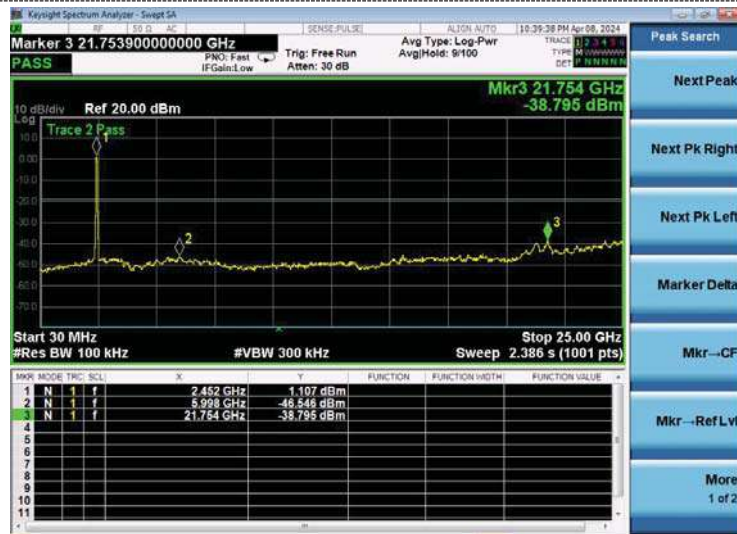

CH09

Band-edge Measurements for RF Conducted Emissions:

802.11b

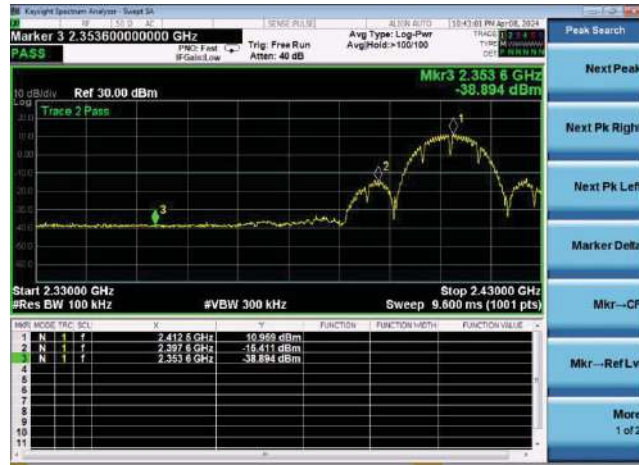

Left bandedge



Right bandedge

802.11g



Left bandedge



Right bandedge

802.11n(HT20)

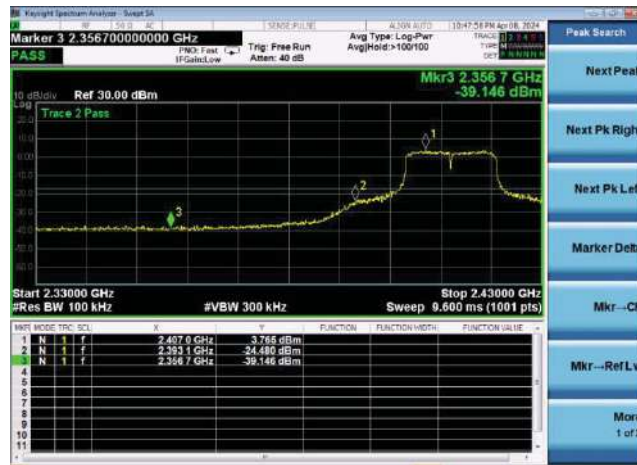

Left bandedge

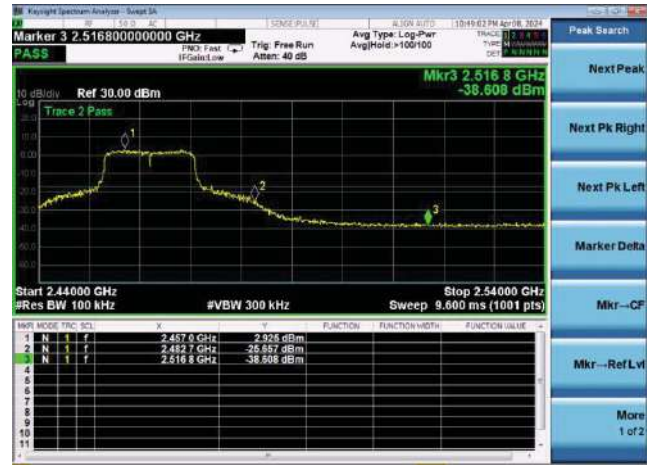

Right bandedge

802.11n(HT40)



Left bandedge



Right bandedge

4.7 Antenna Requirement

Standard Applicable

For intentional device, according to FCC 47 CFR Section 15.203:

An intentional radiator shall be designed to ensure that no antenna other than that furnished by the responsible party shall be used with the device. The use of a permanently attached antenna or of an antenna that uses a unique coupling to the intentional radiator, the manufacturer may design the unit so that a broken antenna can be replaced by the user, but the use of a standard antenna jack or electrical connector is prohibited

FCC CFR Title 47 Part 15 Subpart C Section 15.247(c) (1) (I):

(i) Systems operating in the 2400-2483.5 MHz band that is used exclusively for fixed. Point-to-point operations may employ transmitting antennas with directional gain greater than 6dBi provided the maximum conducted output power of the intentional radiator is reduced by 1 dB for every 3 dB that the directional gain of the antenna exceeds 6dBi.

Test Result:

The maximum gain of antenna was 1.13 dBi.

Remark: The antenna gain is provided by the customer, if the data provided by the customer is not accurate, BSL Testing Co., Ltd. does not assume any responsibility.

5 Test Setup Photos of the EUT

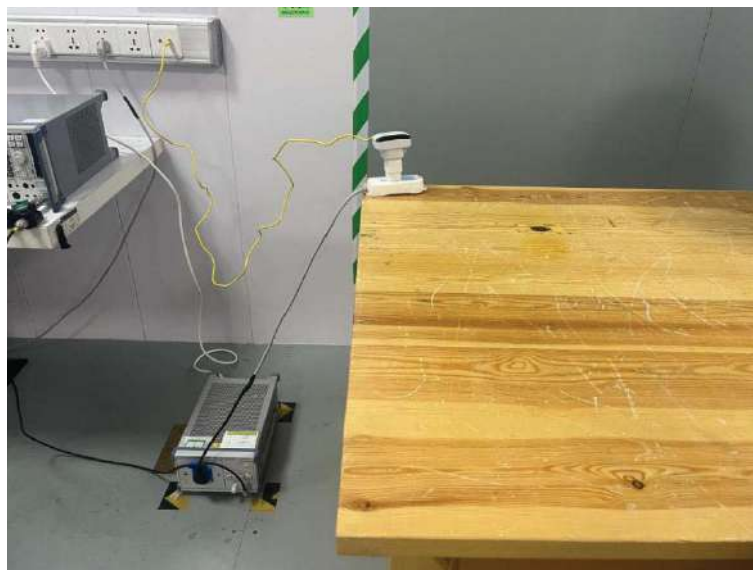
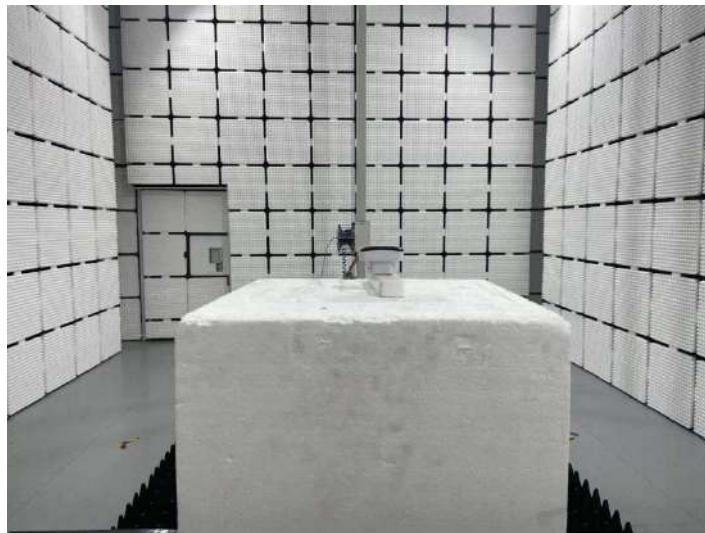



6 Photos of the EUT

Reference to the report ANNEX A of external photos and ANNEX B of internal photos.

******* End of Report *******