

RF MEASUREMENT REPORT

FCC ID: 2BEY3LCUR57WWDB
Applicant: NETPRISMA INC.
Product: LTE-A Cat 16 M.2 Module
Model No.: LCUR57-WWD
Brand Name: Vrileg
FCC Rule(s): Part 2, 22 (H), 24 (E), 27
Result: Complies
Received Date: 2024-04-22
Test Date: 2024-04-28 ~ 2024-05-27

Reviewed By:

Sunny Sun

Approved By:

Robin Wu



The test results relate only to the samples tested.

This equipment has been shown to be capable of compliance with the applicable technical standards as indicated in the measurement report and was tested in accordance with the measurement procedures specified in ANSI C63.26-2015. Test results reported herein relate only to the item(s) tested.

The test report shall not be reproduced except in full without the written approval of MRT Technology (Suzhou) Co., Ltd.

Revision History

Report No.	Version	Description	Issue Date	Note
2404RSU035-U1	V01	Initial Report	2024-06-07	Valid

CONTENTS

Description	Page
1. General Information	5
1.1. Applicant	5
1.2. Manufacturer.....	5
1.3. Testing Facility	5
1.4. Product Information	6
1.5. Radio Specification under Testing	6
1.6. Description of Available Antennas	7
1.7. Test Methodology	7
2. Test Configuration	8
2.1. Test System Connection Diagram	8
2.2. Test Environment Condition.....	8
3. Measuring Instrument	9
4. Decision Rules and Measurement Uncertainty	11
4.1. Decision Rules.....	11
4.2. Measurement Uncertainty	11
5. Test Result.....	12
5.1. Summary	12
5.2. Occupied Bandwidth Measurement	13
5.2.1. Test Limit.....	13
5.2.2. Test Procedure	13
5.2.3. Test Setting	13
5.2.4. Test Setup.....	13
5.2.5. Test Result	13
5.3. Frequency Stability Measurement	14
5.3.1. Test Limit.....	14
5.3.2. Test Procedure	14
5.3.3. Test Setting	14
5.3.4. Test Setup.....	15
5.3.5. Test Result	15
5.4. Transmitter Output Power Measurement	16
5.4.1. Test Limit.....	16
5.4.2. Test Procedure	16
5.4.3. Test Setting	16
5.4.4. Test Setup.....	17

5.4.5.	Test Result	17
5.5.	Peak to Average Ratio Measurement	18
5.5.1.	Test Limit	18
5.5.2.	Test Procedure	18
5.5.3.	Test Setting	18
5.5.4.	Test Setup	18
5.5.5.	Test Result	18
5.6.	Transmitter unwanted emissions (band-edge) Measurement	19
5.6.1.	Test Limit	19
5.6.2.	Test Procedure	19
5.6.3.	Test Setting	19
5.6.4.	Test Setup	20
5.6.5.	Test Result	20
5.7.	Transmitter unwanted emissions (spurious) Measurement	21
5.7.1.	Test Limit	21
5.7.2.	Test Procedure	21
5.7.3.	Test Setting	21
5.7.4.	Test Setup	22
5.7.5.	Test Result	22
5.8.	Radiated Spurious Emissions Measurement	23
5.8.1.	Test Limit	23
5.8.2.	Test Procedure	23
5.8.3.	Test Setting	23
5.8.4.	Test Setup	24
5.8.5.	Test Result	24
Appendix A - Test Result		25
A.1	Occupied Bandwidth Test Result	25
A.2	Frequency Stability Test Result	28
A.3	Transmitter Output Power Test Result	31
A.4	Peak to Average Radio Test Result	34
A.5	Transmitter unwanted emissions (band-edge) Test Result	36
A.6	Transmitter unwanted emissions (spurious) Test Result	38
A.7	Radiated Spurious Emissions Test Result	42
Appendix B - Test Setup Photograph		48
Appendix C - EUT Photograph		49

1.4. Product Information

Product Name	LTE-A Cat 16 M.2 Module
Model No.	LCUR57-WWD
Brand Name	Vrileg
Serial No.	D1C24CG1D000013 (Conducted) D1C24CG1D000108 (Radiated)
3GPP Specification	WCDMA Band II/IV/V LTE Band 2, 4, 5, 7, 12, 13, 14, 25, 26, 30, 38, 41, 42, 43, 48, 66
Operating Temperature Range	-25 ~ 75 °C
Supply Voltage Rating	3.135 – 4.4Vdc, typical 3.7Vdc
Antenna Specification	Refer to Section 1.6
Remark: The information of EUT was provided by the manufacturer, and the accuracy of the information shall be the responsibility of the manufacturer.	

1.5. Radio Specification under Testing

UMTS Specification	
TX Frequency Range:	WCDMA Band II: 1850 ~ 1910MHz, WCDMA Band IV: 1710 ~ 1755MHz WCDMA Band V: 824 ~ 849MHz
RX Frequency Range:	WCDMA Band II: 1930 ~ 1990MHz, WCDMA Band IV: 2110 ~ 2155MHz WCDMA Band V: 869 ~ 894MHz
Support Power Class	PC3
Modulation	UL up to QPSK, DL up to 64QAM
Category	HSDPA: 24; HSUPA: 6

1.6. Description of Available Antennas

Technology	Frequency Range (MHz)	Antenna Type	Max Peak Gain (dBi)
WCDMA Band II	1850 ~ 1910	PIFA	3.87
WCDMA Band IV	1710 ~ 1755		3.91
WCDMA Band V	824 ~ 849		3.32
Note 1: All antenna information (Antenna type and Peak Gain) is provided by the manufacturer. Note 2: The typical antennas used to calculate the ERP (EIRP).			

1.7. Test Methodology

According to the specifications of the manufacturer, the EUT must comply with the requirements of the following standards:

- ANSI C63.26:2015
- FCC CFR 47 Part 2, Part 22, Part 24, Part 27
- FCC KDB 971168 D01 v03r01: Power Meas License Digital Systems
- FCC KDB 971168 D02 v02r01: Misc Rev Approv License Devices
- FCC KDB 412172 D01 v01r01: Determining ERP and EIRP

2. Test Configuration

2.1. Test System Connection Diagram

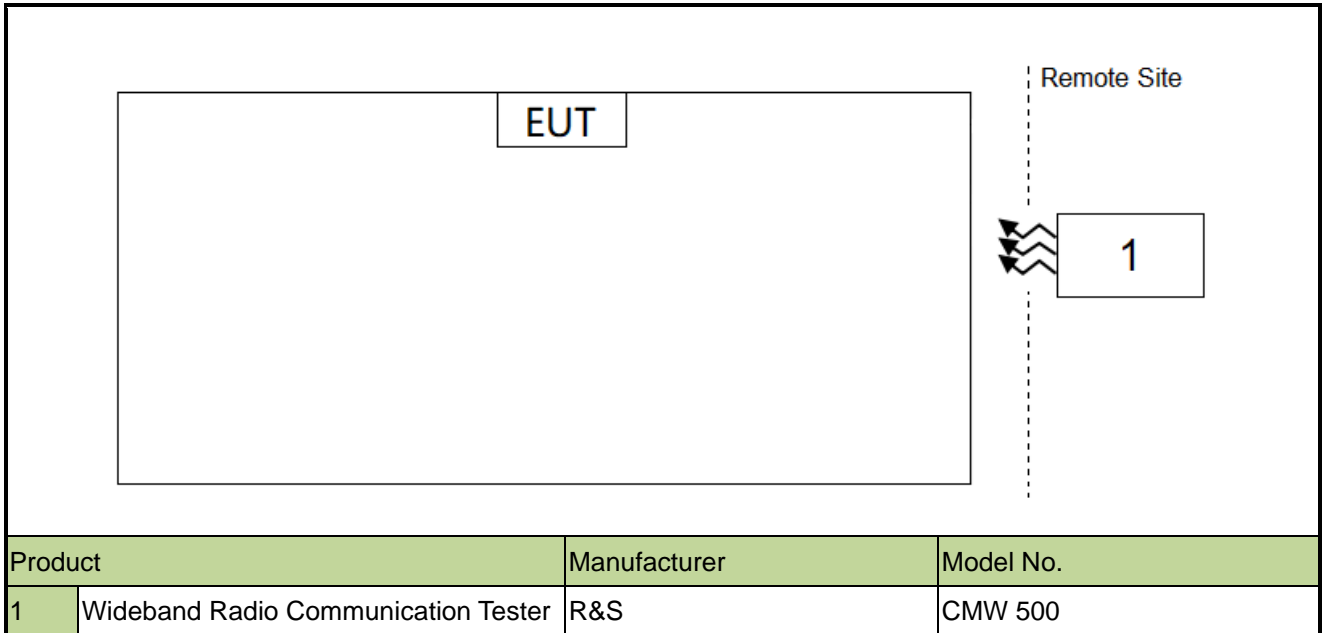

2.2. Test Environment Condition

Ambient Temperature	15 ~ 35°C
Relative Humidity	20% ~ 75%RH

3. Measuring Instrument

Instrument	Manufacturer	Model No.	Asset No.	Cali. Interval	Cali. Due Date	Test Site
Communication Tester	R&S	CMW500	MRTSUE06243	1 year	2024-09-27	SIP-SR1
Thermohygrometer	testo	622	MRTSUE06629	1 year	2024-12-21	SIP-SR1
Communication Tester	R&S	CMW500	MRTSUE06881	1 year	2024-05-09	SIP-SR1
				1 year	2025-05-08	SIP-SR1
Temperature Chamber	BAOYT	BYG-80CL	MRTSUE06932	1 year	2025-02-03	SIP-SR1
Shielding Room	MIX-BEP	SIP-SR1	MRTSUE06948	N/A	N/A	SIP-SR1
Directional Coupler	MVE	MVE4912-10	MRTSUE07052	1 year	2024-08-24	SIP
Attenuator	MVE	MVE2213	MRTSUE11111	1 year	2024-08-02	SIP
Signal Analyzer	Keysight	N9010B	MRTSUE07028	1 year	2024-10-23	SIP-SR1
Directional Coupler	MVE	MVE4816-10	MRTSUE11120	1 year	2024-08-24	SIP
Communication Tester	R&S	CMW500	MRTSUE06108	1 year	2024-10-23	WZ-SR6
Thermohygrometer	testo	608-H1	MRTSUE06362	1 year	2025-02-04	WZ-SR6
Shielding Room	HUAMING	WZ-SR6	MRTSUE06443	N/A	N/A	WZ-SR6
Radio Communication Analyzer	Anritsu	MT8821C	MRTSUE06960	1 year	2024-07-06	WZ-SR6
Temperature Chamber	BAOYT	BYH-150CL	MRTSUE06051	1 year	2024-09-27	WZ-TR3
Thermohygrometer	testo	608-H1	MRTSUE11268	1 year	2024-12-14	WZ-TR3
Thermohygrometer	testo	608-H1	MRTSUE06362	1 year	2025-02-04	WZ-SR6
Shielding Room	HUAMING	WZ-SR6	MRTSUE06443	N/A	N/A	WZ-SR6
Signal Analyzer	Keysight	N9020B	MRTSUE06583	1 year	2024-09-27	WZ-SR6
USB Power Sensor	Keysight	U8488A	MRTSUE06958	5 years	2026-07-08	SIP-SR3
Thermohygrometer	testo	608-H1	MRTSUE06616	1 year	2024-10-28	SIP-AC1
Horn Antenna	R&S	HF907	MRTSUE06610	1 year	2024-06-17	SIP-AC1
EMI Test Receiver	R&S	ESR3	MRTSUE06185	1 year	2024-12-17	SIP-AC1
Anechoic Chamber	RIKEN	SIP-AC1	MRTSUE06554	1 year	2024-12-21	SIP-AC1
Signal Analyzer	Keysight	N9010B	MRTSUE06559	1 year	2024-05-09	SIP-AC1
				1 year	2025-05-08	SIP-AC1
Horn Antenna	Schwarzbeck	BBHA 9170	MRTSUE06599	1 year	2024-09-24	SIP-AC1
Preamplifier	EMCI	EMC184045SE	MRTSUE06602	1 year	2024-10-09	SIP-AC1
Loop Antenna	Schwarzbeck	FMZB 1519 B	MRTSUE06937	1 year	2025-01-27	SIP-AC1
Signal Analyzer	Keysight	N9010B	MRTSUE07028	1 year	2024-10-23	SIP-AC1
Active Loop Antenna	Schwarzbeck	FMZB 1519-60 D	MRTSUE07075	1 year	2024-12-04	SIP-AC1
Cable	HUBER+SUHNER	SF106	MRTSUE06594	1 year	2024-12-21	SIP-AC1
Cable	HUBER+SUHNER	SF106	MRTSUE06874	1 year	2024-12-21	SIP-AC1

Software	Version	Function
EMI Software	V3.0.0	EMI Test Software
Controller_MF 7802BS	1.02	RE Antenna & Turntable
CMWrun	V 1.9.10.20	license 2G & 3G & 4G
UCTS	V 6.23.217.99	license 3G & 4G & 5G
Agilent Power Analyzer/Agilent Power Panel	V R03.09.00	Power

4. Decision Rules and Measurement Uncertainty

4.1. Decision Rules

The Decision Rule is based on Simple Acceptance in accordance with ISO Guide 98-4: 2012 Clause 8.2. (Measurement uncertainty is not taken into account when stating conformity with a specified requirement.)

4.2. Measurement Uncertainty

Where relevant, the following test uncertainty levels have been estimated for tests performed on the EUT as specified in CISPR 16-4-2. This uncertainty represents an expanded uncertainty expressed at approximately the 95% confidence level using a coverage factor of $k = 2$.

Radiated Spurious Emissions
Measurement Uncertainty for a Level of Confidence of 95% ($U=2Uc(y)$):
Coaxial: 9kHz~30MHz: 2.61dB
Coplanar: 9kHz~30MHz: 2.62dB
Horizontal: 30MHz~200MHz: 3.79dB
200MHz~1GHz: 3.91dB
1GHz~40GHz: 4.99dB
Vertical: 30MHz~200MHz: 4.06dB
200MHz~1GHz: 5.21dB
1GHz~40GHz: 4.90dB
Conducted Spurious Emissions
Measuring Uncertainty for a Level of Confidence of 95% ($U=2Uc(y)$):
1.47dB
Output Power
Measuring Uncertainty for a Level of Confidence of 95% ($U=2Uc(y)$):
0.66dB
Occupied Bandwidth
Measuring Uncertainty for a Level of Confidence of 95% ($U=2Uc(y)$):
69.28kHz
Frequency Stability
Measuring Uncertainty for a Level of Confidence of 95% ($U=2Uc(y)$):
8.04Hz

5. Test Result

5.1. Summary

FCC Part Section(s)	Test Description	Test Condition	Test Result
2.1049	Occupied Bandwidth	Conducted	Pass
2.1055, 22.355, 24.235, 27.54	Frequency Stability		Pass
22.913(a)(5), 24.232(c) 27.50(d)(4)	Transmitter Output Power		Pass
22.913(d), 24.232(d), 27.50(d)(5)	Peak to Average Ratio		Pass
2.1051, 22.917(a), 24.238(a) 27.53(h)	Transmitter unwanted emissions (band-edge)		Pass
2.1051, 22.917(a), 24.238(a) 27.53 (h)	Transmitter unwanted emissions (spurious)		
2.1051, 22.917(a), 24.238(a) 27.53 (h)	Transmitter Spurious Emissions	Radiated	Pass

Notes:

- 1) The analyzer plots shown in this section were all taken with a correction table loaded into the analyzer. The correction table was used to account for the losses of the cables and attenuators used as part of the system to connect the EUT to the analyzer at all frequencies of interest.
- 2) All supported modulation types were evaluated. The worst-case emission of modulation was selected. The power of HSDPA/HSUPA is lower than that of WCDMA. Therefore, the Frequency Stability, Transmitter unwanted emissions (band-edge), Transmitter unwanted emissions (spurious), Radiated Spurious Emission were presented worst-case in the test report.
- 3) For radiated emission tests, every axis (X, Y, Z) was also verified. The test results shown in the following sections represent the worst-case emissions.
- 4) This report is based on MRT Original "2404RSU035-U1" Report, FCC ID: 2BEY3LCUR57WWDA to copying report and updating the FCC ID.

5.2. Occupied Bandwidth Measurement

5.2.1. Test Limit

The occupied bandwidth, that is the frequency bandwidth such that, below its lower and above its upper frequency limits, the mean powers radiated are each equal to 0.5 percent of the total mean power radiated by a given emission shall be measured.

5.2.2. Test Procedure

ANSI C63.26-2015 - Section 5.4.4

5.2.3. Test Setting

1. Set center frequency to the nominal EUT channel center frequency
2. RBW = The nominal RBW shall be in the range of 1% to 5% of the anticipated OBW
3. VBW $\geq 3 \times$ RBW
4. Detector = Peak
5. Trace mode = max hold
6. Sweep = auto couple
7. Allow the trace to stabilize
8. Use the 99% power bandwidth function of the instrument and report the measured bandwidth.

5.2.4. Test Setup

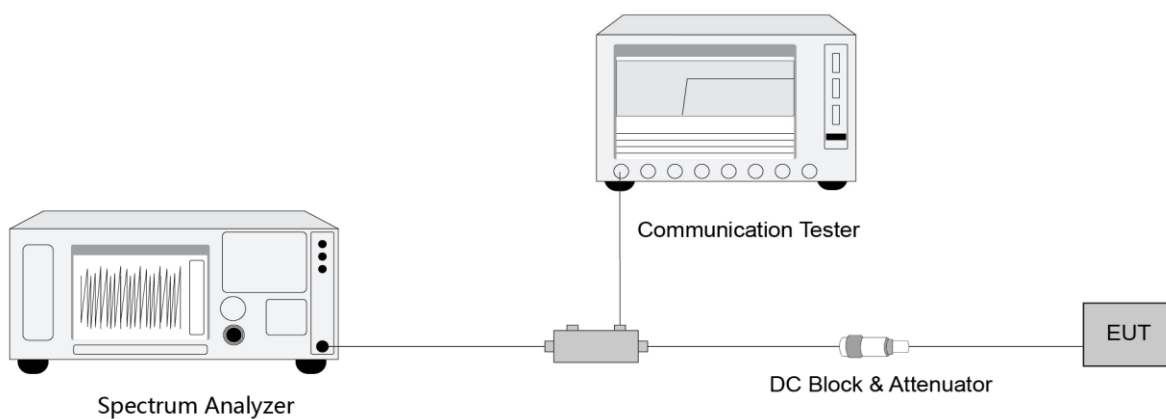

5.2.5. Test Result

Refer to Appendix A.1.

5.3. Frequency Stability Measurement

5.3.1. Test Limit

The frequency stability shall be measured by variation of ambient temperature and variation of primary supply voltage to ensure that the fundamental emission stays within the authorized frequency block.

5.3.2. Test Procedure

ANSI C63.26-2015 - Section 5.6

5.3.3. Test Setting

1. A reference point shall be established at the applicable unwanted emissions limit using a RBW equal to the RBW required by the unwanted emissions specification of the applicable regulatory standard. These reference points measured using the lowest and highest channel of operation shall be identified as f_L and f_H respectively.
2. Use the frequency error function of the instrument and record the frequency error.
3. Change the temperature of equipment and repeat Steps 2.
4. Change the Voltage of equipment and repeat Steps 2.
5. The frequency error offset determined in the above methods shall be added or subtracted from the values of f_L and f_H and the resulting frequencies must remain within the band

Frequency Stability Under Temperature Variations:

The equipment under test was connected to an external AC or DC power supply and input rated voltage. RF output was connected to a frequency counter or spectrum analyzer via feed through attenuators. The EUT was placed inside the temperature chamber. Set the spectrum analyzer RBW low enough to obtain the desired frequency resolution and measure EUT 20°C operating frequency as reference frequency. Turn EUT off and set the chamber temperature to highest. After the temperature stabilized for approximately 30 minutes recorded the frequency. Repeat step measure with 10°C decreased per stage until the lowest temperature reached.

Frequency Stability Under Voltage Variations:

Set chamber temperature to 20°C. Use a variable AC power supply / DC power source to power the EUT and set the voltage to rated voltage. Set the spectrum analyzer RBW low enough to obtain the desired frequency resolution and recorded the frequency.

Reduce the input voltage to specify extreme voltage variation ($\pm 15\%$) and endpoint, record the maximum frequency change.

5.3.4. Test Setup

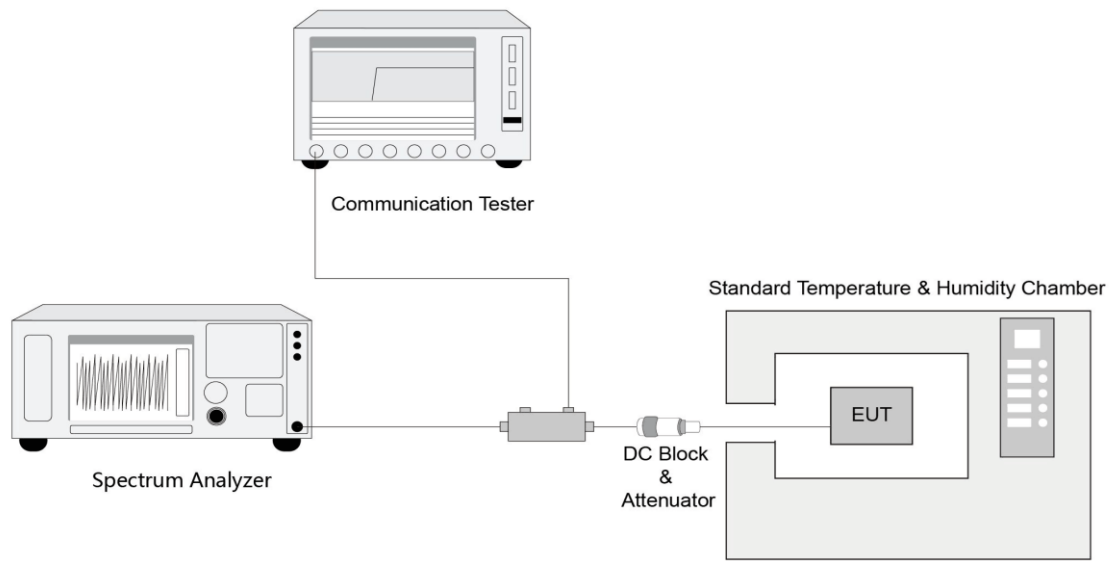

5.3.5. Test Result

Refer to Appendix A.2.

5.4. Transmitter Output Power Measurement

5.4.1. Test Limit

Band II:

Mobile and portable stations are limited to 2 watts EIRP and the equipment must employ a means for limiting power to the minimum necessary for successful communications.

Band IV:

Fixed, mobile stations operating in the 1710-1755 MHz band and mobile in the 1695-1710 MHz and 1755-1780 MHz bands are limited to 1 watt EIRP.

Band V:

The ERP of mobile transmitters and auxiliary test transmitters must not exceed 7 watts.

5.4.2. Test Procedure

ANSI C63.26-2015 - Section 5.2.4.2

5.4.3. Test Setting

Average power measurements were performed only when the EUT was transmitting at its maximum power control level using a broadband power meter with a pulse sensor. The power meter implemented triggering and gating capabilities which were set up such that power measurements were recorded only during the ON time of the transmitter.

The relevant equation for determining the maximum ERP or EIRP from the measured RF output power is given in Equation (1) as follows:

$$\text{ERP or EIRP} = P_{\text{Meas}} + G_T$$

where

ERP or EIRP effective radiated power or equivalent isotropically radiated power, respectively (expressed in the same units as P_{Meas} , e.g., dBm or dBW)

P_{Meas} measured transmitter output power or PSD, in dBm or dBW

G_T gain of the transmitting antenna, in dBd (ERP) or dBi (EIRP)

$$\text{ERP} = \text{EIRP} - 2.15$$

5.4.4. Test Setup

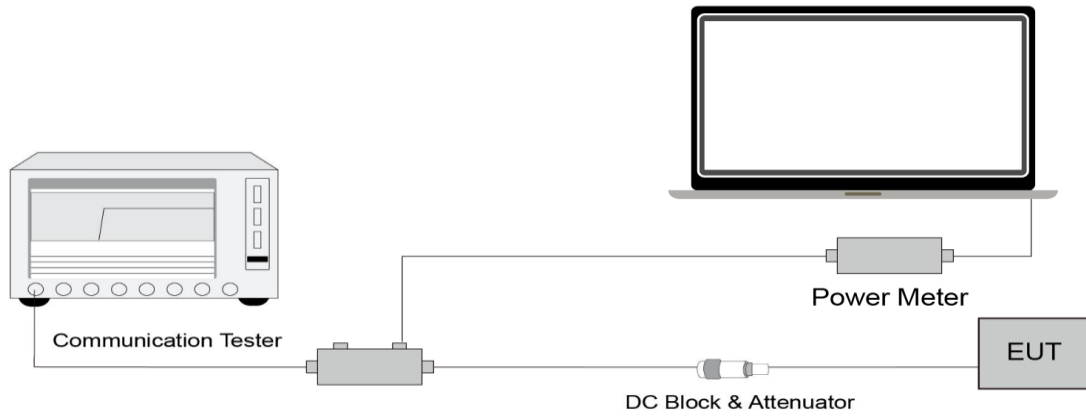

5.4.5. Test Result

Refer to Appendix A.3.

5.5. Peak to Average Ratio Measurement

5.5.1. Test Limit

A peak to average ratio measurement is performed at the conducted port of the EUT. The spectrum analyzers Complementary Cumulative Distribution Function (CCDF) measurement profile is used to determine the largest deviation between the average and the peak power of the EUT in a given bandwidth. The CCDF curve shows how much time the peak waveform spends at or above a given average power level. The percent of time the signal spends at or above the level defines the probability for that particular power level.

5.5.2. Test Procedure

ANSI C63.26-2015 - Section 5.2.3.4 (CCDF).

5.5.3. Test Setting

1. Set the resolution / measurement bandwidth \geq signal's occupied bandwidth
2. Set the number of counts to a value that stabilizes the measured CCDF curve
3. Record the maximum PARR level associated with a probability of 0.1%

5.5.4. Test Setup

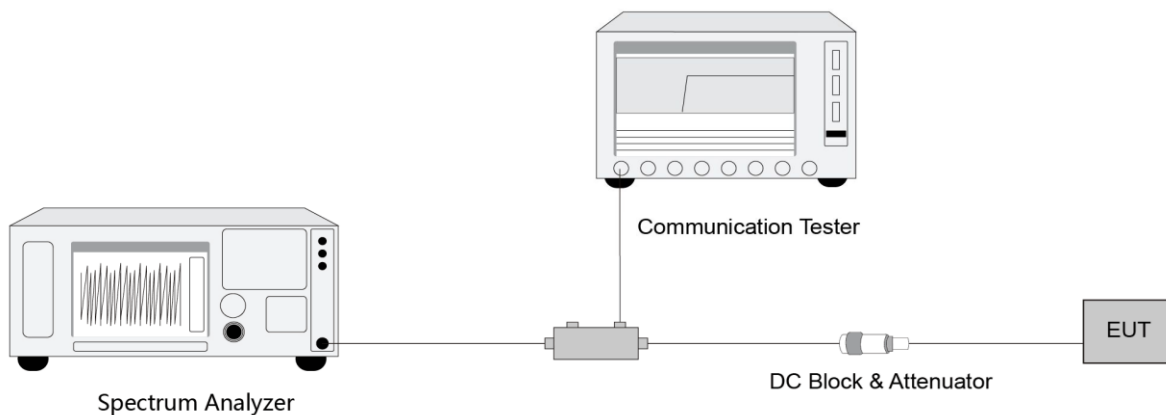

5.5.5. Test Result

Refer to Appendix A.4

5.6. Transmitter unwanted emissions (band-edge) Measurement

5.6.1. Test Limit

22.917(a), 24.238 (a), 27.53 (h)

For operations in the 824 ~ 849 MHz, 1850 ~ 1910 MHz, 1930 ~ 1990 MHz, and 1710 ~ 1755 MHz, the FCC limit is $43 + 10\log_{10}(P_{\text{Watts}})$ dB below the transmitter power P(Watts) in a 1 MHz bandwidth. However, in the 1MHz bands immediately outside and adjacent to the licensee's frequency block, a resolution bandwidth of at least one percent of the emission bandwidth of the fundamental emission of the transmitter may be employed.

5.6.2. Test Procedure

ANSI C63.26-2015 - Section 5.7

5.6.3. Test Setting

1. Set the analyzer frequency to Low or High channel
2. RBW = specified resolution bandwidth, for improvement of the accuracy in the measurement of the average power of a noise-like emission, a RBW narrower than the specified reference bandwidth can be used (generally limited to no less than 1% of the frequency block group, provided that a subsequent integration is performed over the full required measurement bandwidth. This integration should be performed using the spectrum analyzer's band power functions.
3. VBW $\geq 3 \cdot$ RBW
4. Sweep time = auto
5. Detector = power averaging (rms)
6. If the EUT can be configured to transmit continuously, then set the trigger to free run
7. If the EUT cannot be configured to transmit continuously, then use a sweep trigger with the level set to enable triggering only on full power bursts and configure the EUT to transmit at full power for the entire duration of each sweep. Verify that the sweep time is less than or equal to the transmission burst duration. Time gating can also be used under similar constraints
8. Trace average at least 100 traces in power averaging (rms) mode if sweep is set to auto-couple. To accurately determine the average power over the on and off time of the transmitter, it can be necessary to increase the number of traces to be averaged above 100, or if using a manually configured sweep time, increase the sweep time.
9. Compute the power by integrating the spectrum across the specified resolution bandwidth using the instrument's band or channel power measurement function, with the band/channel limits set equal to the specified resolution bandwidth, when using a measurement bandwidth smaller than the specified

bandwidth. Otherwise, Use the peak marker function to determine the maximum amplitude level.

5.6.4. Test Setup

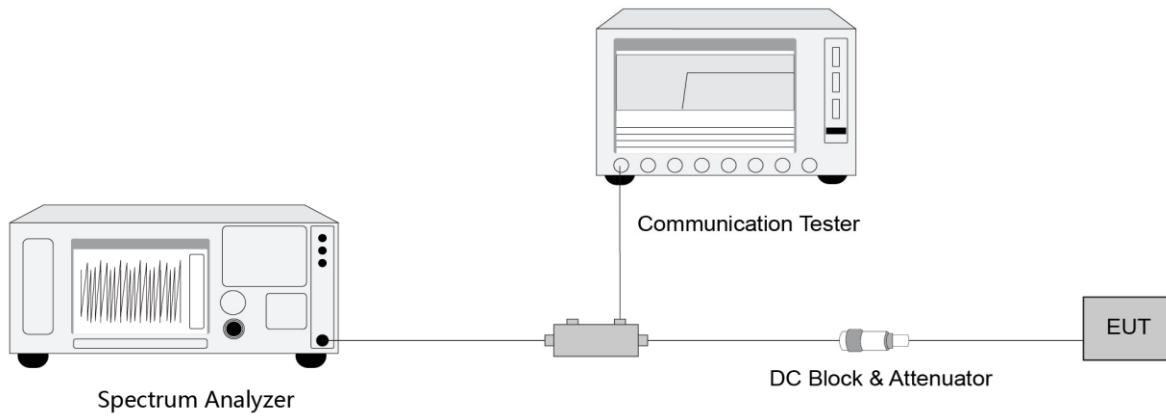

5.6.5. Test Result

Refer to Appendix A.5.

5.7. Transmitter unwanted emissions (spurious) Measurement

5.7.1. Test Limit

The level of the carrier and the various conducted spurious and harmonic frequencies is measured by means of a calibrated spectrum analyzer. The spectrum is scanned from the lowest frequency generated in the equipment up to a frequency including its 10th harmonic. All out of band emissions are measured with a spectrum analyzer connected to the antenna terminal of the EUT while the EUT is operating at its maximum duty cycle, at maximum power, and at the appropriate frequencies. All data rates were investigated to determine the worst-case configuration. All modes of operation were investigated and the worst-case configuration results are reported in this section.

The power of any emission outside of the authorized operating frequency ranges must be attenuated below the transmitting power (P) by a factor of at least $43 + 10 \log(P)$ dB.

5.7.2. Test Procedure

ANSI C63.26-2015 - Section 5.7

5.7.3. Test Setting

1. Set the analyzer frequency to low, Mid or high channel.
2. RBW = specified resolution bandwidth
3. VBW $\geq 3 \cdot$ RBW
4. Sweep time = auto
5. Detector = power averaging (rms)
6. If the EUT can be configured to transmit continuously, then set the trigger to free run
7. If the EUT cannot be configured to transmit continuously, then use a sweep trigger with the level set to enable triggering only on full power bursts and configure the EUT to transmit at full power for the entire duration of each sweep. Verify that the sweep time is less than or equal to the transmission burst duration.
Time gating can also be used under similar constraints
8. Trace average at least 100 traces in power averaging (rms) mode if sweep is set to auto-couple. To accurately determine the average power over the on and off time of the transmitter, it can be necessary to increase the number of traces to be averaged above 100, or if using a manually configured sweep time, increase the sweep time.
9. Use the peak marker function to determine the maximum amplitude level.

5.7.4. Test Setup

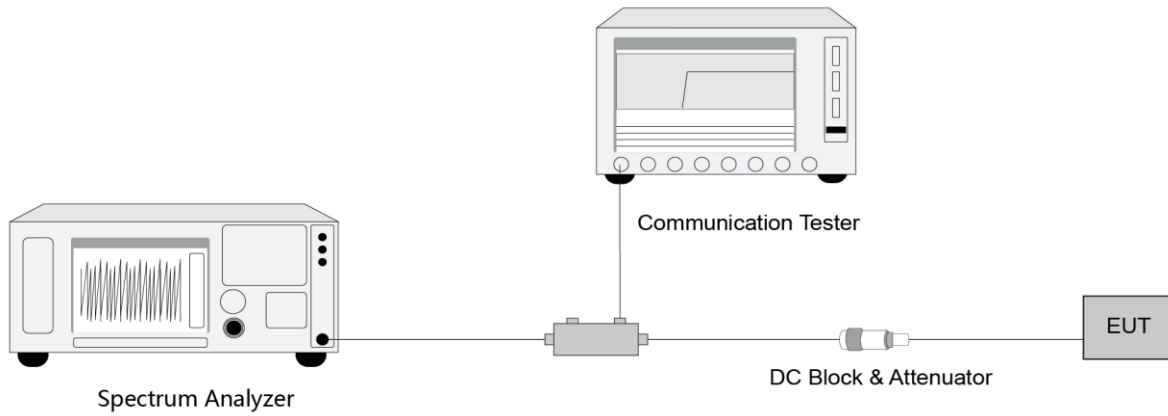

5.7.5. Test Result

Refer to Appendix A.6

5.8. Radiated Spurious Emissions Measurement

5.8.1. Test Limit

The power of any emission outside of the authorized operating frequency ranges must be attenuated below the transmitting power (P) by a factor of at least $43 + 10 \log(P)$ dB. The emission limit equal to -13dBm.

E (dB μ V/m) = EIRP (dBm) - 20 log D + 104.8; where D is the measurement distance in meters. The emission limit equal to 82.3dB μ V/m.

5.8.2. Test Procedure

ANSI C63.26-2015 - Section 5.2.7 & 5.5

5.8.3. Test Setting

1. RBW = 120kHz or 1MHz
2. VBW \geq 3*RBW
3. Sweep time \geq 10 \times (number of points in sweep) \times (transmission symbol period)
4. Detector = CISPR quasi-peak / average detector (Below 1 GHz, compliance with the limits shall be demonstrated using a CISPR quasi-peak detector and the related measurement bandwidth. Above 1 GHz, compliance with the limits shall be demonstrated using a linear average detector with a minimum resolution bandwidth of 1 MHz.)
5. The trace was allowed to stabilize

5.8.4. Test Setup

Below 1GHz Test Setup:

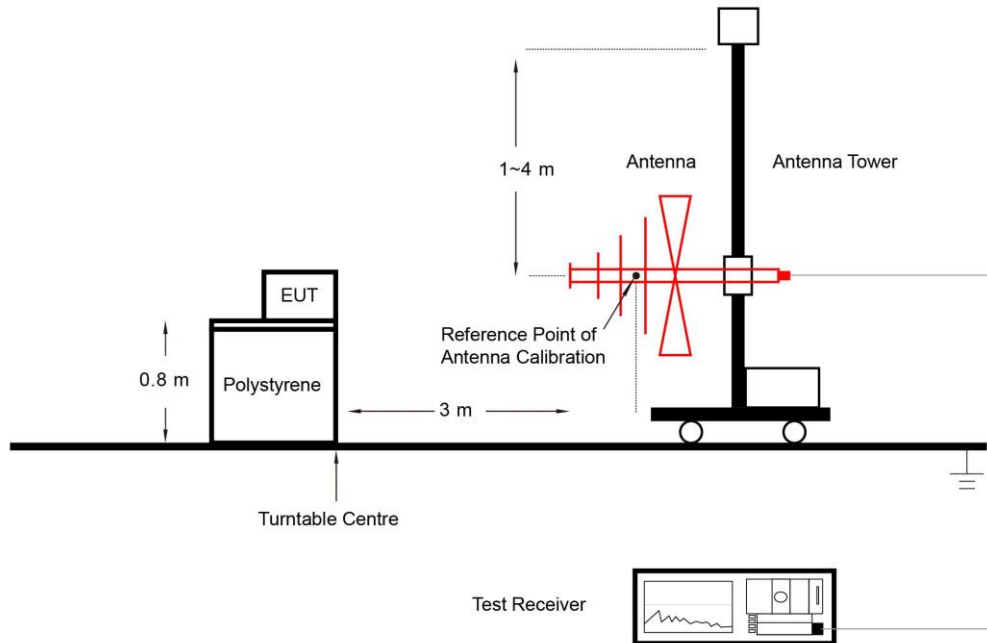

Above 1GHz Test Setup:

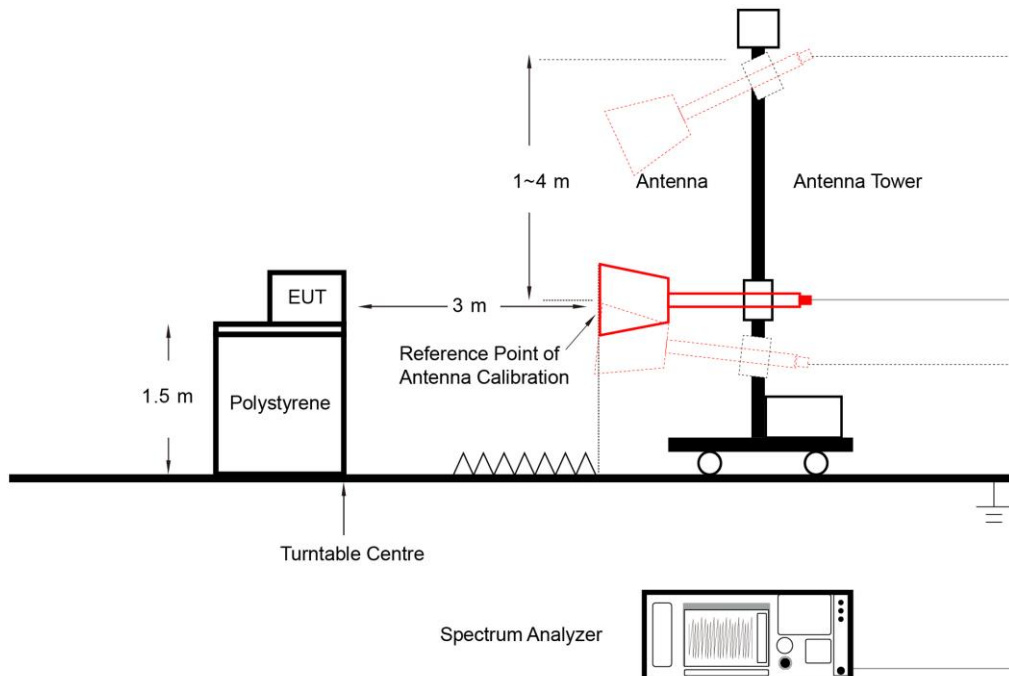

5.8.5. Test Result

Refer to Appendix A.7.

Appendix A - Test Result

A.1 Occupied Bandwidth Test Result

Test Site	SIP-SR1	Test Engineer	Yoniter Yang
Test Date	2024-05-17	Test Band	WCDMA Band II

Channel	Frequency (MHz)	99% Bandwidth (MHz)
Low	1852.4	4.14
Middle	1880.0	4.14
High	1907.6	4.14

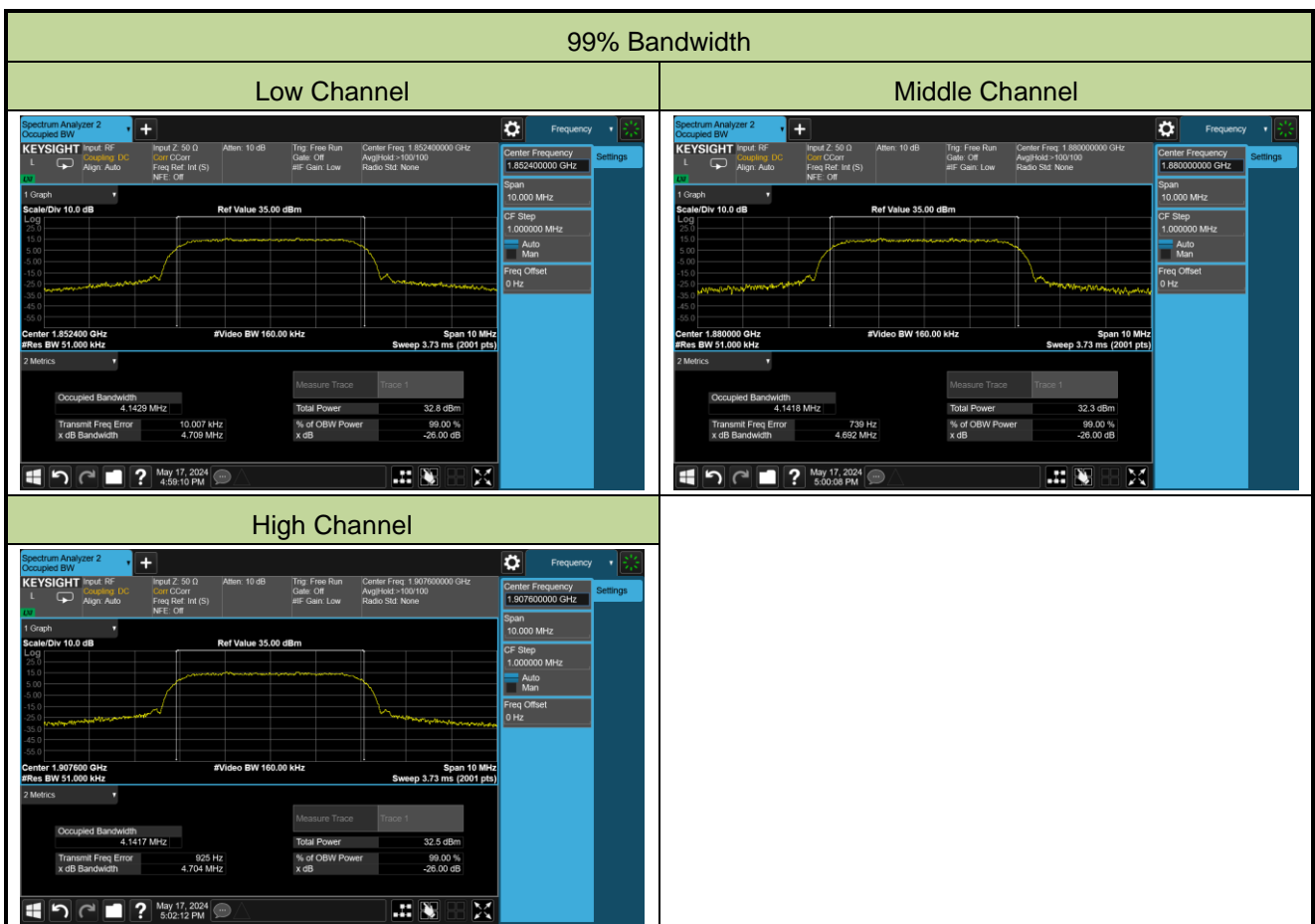

Test Site	SIP-SR1	Test Engineer	Yoniter Yang
Test Date	2024-05-17	Test Band	WCDMA Band IV

Channel	Frequency (MHz)	99% Bandwidth (MHz)
Low	1712.4	4.15
Middle	1732.4	4.14
High	1752.6	4.14

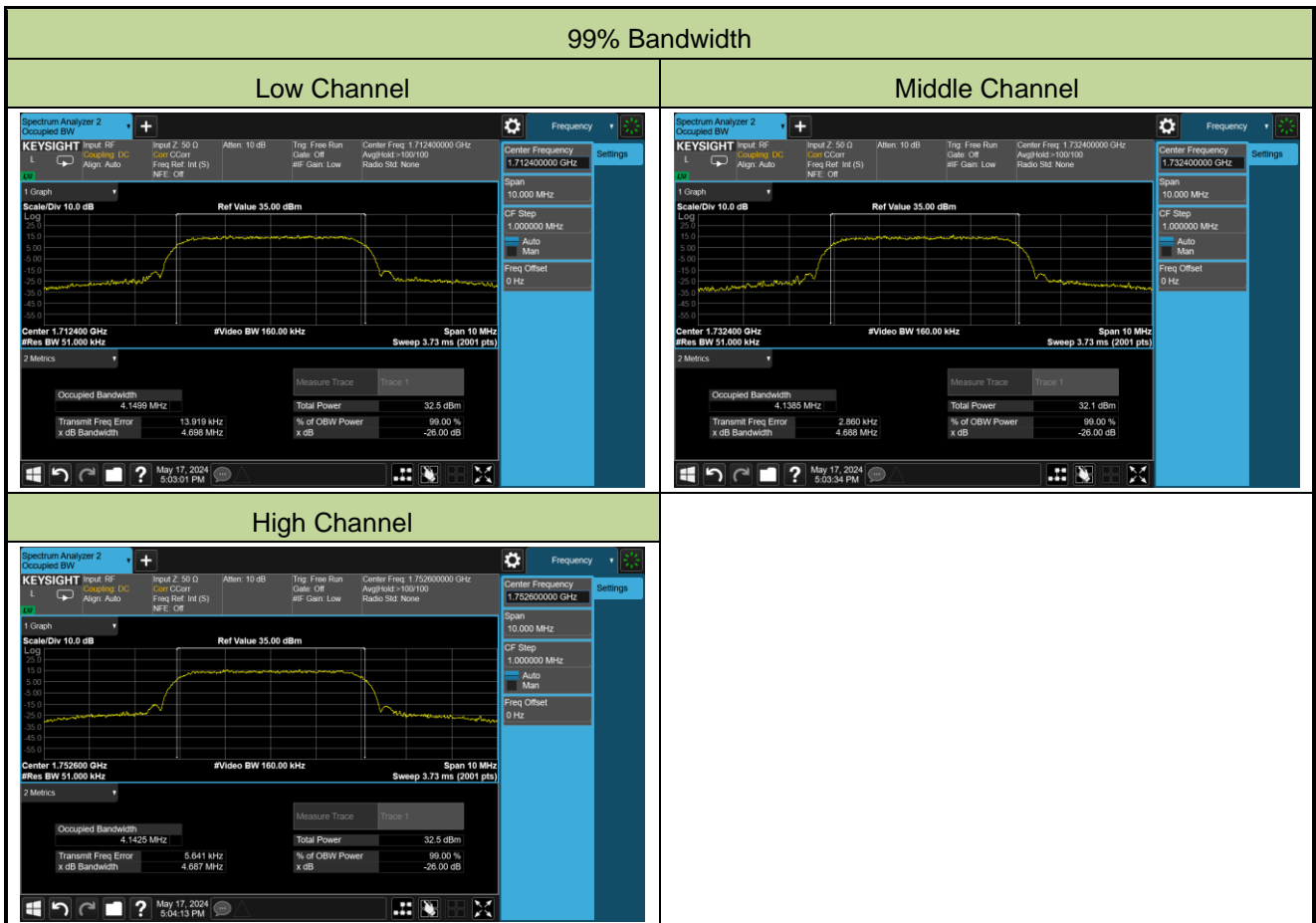

Test Site	SIP-SR1	Test Engineer	Yoniter Yang
Test Date	2024-05-17	Test Band	WCDMA Band V

Channel	Frequency (MHz)	99% Bandwidth (MHz)
Low	826.4	4.14
Middle	836.4	4.15
High	846.6	4.13

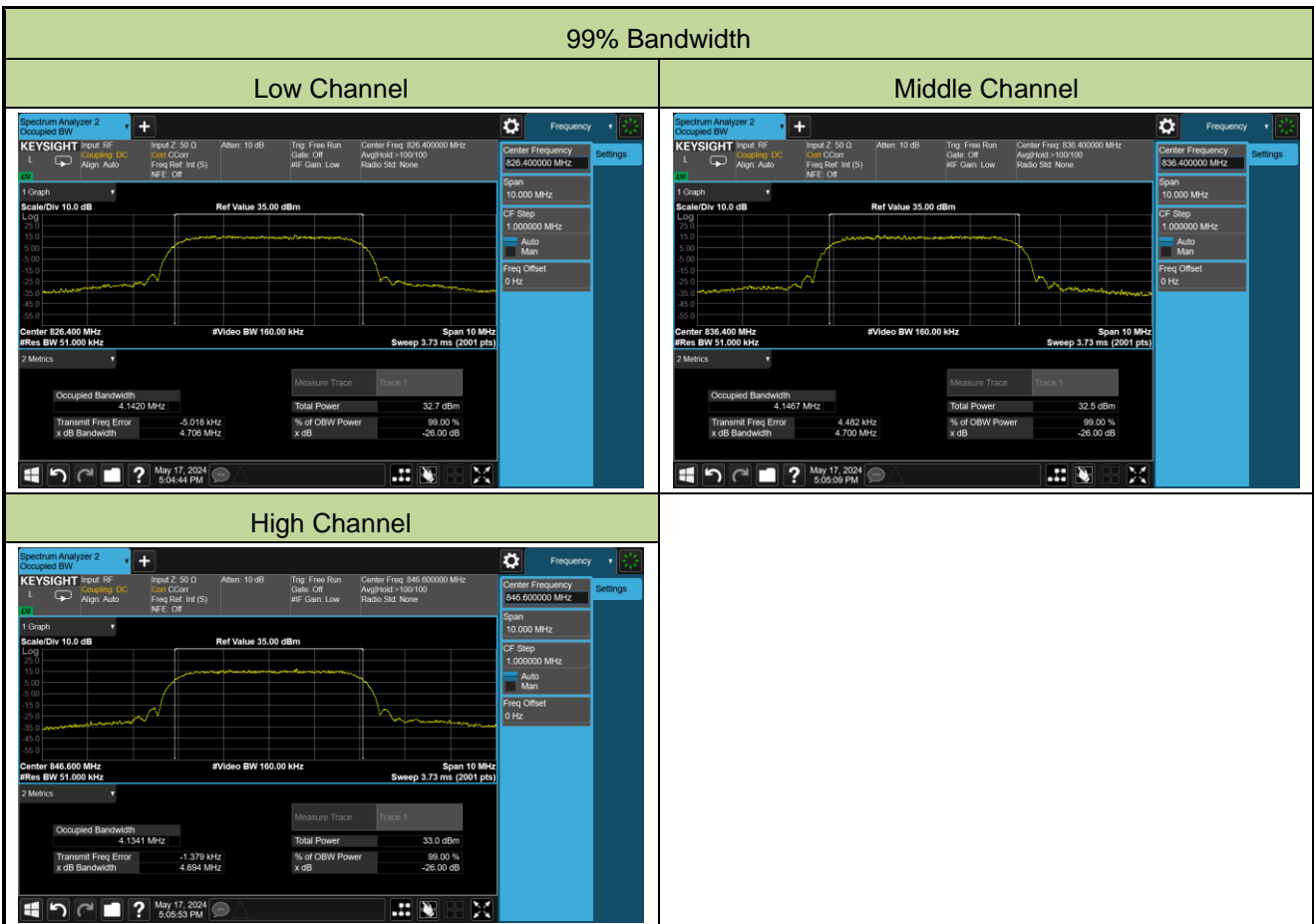

A.2 Frequency Stability Test Result

Test Site	WZ-TR3	Test Engineer	Jone Zhang
Test Date	2024-05-24 ~ 2024-05-27	Test Band	WCDMA Band II

Voltage	Temp (°C)	Frequency Range (MHz)		Delta (Hz)	Frequency stability (ppm)	Within Authorized Frequency Block
		1850.0	1910.0			
		f _L	f _H			
Normal	+ 20 (Ref)	1850.3200	1909.6950	0.00	0.0000	Pass
	+ 50	1850.3200	1909.6950	12.60	0.0067	Pass
	+ 40	1850.3200	1909.6950	13.00	0.0069	Pass
	+ 30	1850.3200	1909.6950	13.70	0.0073	Pass
	+ 10	1850.3200	1909.6950	16.20	0.0086	Pass
	0	1850.3200	1909.6950	16.10	0.0086	Pass
	- 10	1850.3200	1909.6950	15.80	0.0084	Pass
	- 20	1850.3200	1909.6950	15.50	0.0082	Pass
- 30	1850.3200	1909.6950	14.30	0.0076	Pass	
15%	+ 20	1850.3200	1909.6950	14.80	0.0079	Pass
-15%	+ 20	1850.3200	1909.6950	14.60	0.0078	Pass

Test Site	WZ-TR3	Test Engineer	Yoniter Yang
Test Date	2024-05-24 ~ 2024-05-27	Test Band	WCDMA Band IV

Voltage	Temp (°C)	Frequency Range (MHz)		Delta (Hz)	Frequency stability (ppm)	Within Authorized Frequency Block
		1710.0	1755.0			
		f _L	f _H			
Normal	+ 20 (Ref)	1710.3250	1754.7000	0.00	0.0000	Pass
	+ 50	1710.3250	1754.7000	-0.30	-0.0002	Pass
	+ 40	1710.3250	1754.7000	1.30	0.0008	Pass
	+ 30	1710.3250	1754.7000	5.40	0.0031	Pass
	+ 10	1710.3250	1754.7000	14.40	0.0083	Pass
	0	1710.3250	1754.7000	19.30	0.0111	Pass
	- 10	1710.3250	1754.7000	21.30	0.0123	Pass
	- 20	1710.3250	1754.7000	20.90	0.0121	Pass
- 30	1710.3250	1754.7000	16.20	0.0094	Pass	
15%	+ 20	1710.3250	1754.7000	13.00	0.0075	Pass
-15%	+ 20	1710.3250	1754.7000	12.40	0.0072	Pass

Test Site	WZ-TR3	Test Engineer	Jone Zhang
Test Date	2024-05-24 ~ 2024-05-27	Test Band	WCDMA Band V

Voltage	Temp (°C)	Frequency Range (MHz)		Delta (Hz)	Frequency stability (ppm)	Within Authorized Frequency Block
		824.0	849.0			
		f _L	f _H			
Normal	+ 20 (Ref)	824.3250	848.7000	0.00	0.0000	Pass
	+ 50	824.3250	848.7000	2.60	0.0031	Pass
	+ 40	824.3250	848.7000	3.40	0.0041	Pass
	+ 30	824.3250	848.7000	3.70	0.0044	Pass
	+ 10	824.3250	848.7000	0.20	0.0002	Pass
	0	824.3250	848.7000	2.80	0.0033	Pass
	- 10	824.3250	848.7000	4.00	0.0048	Pass
	- 20	824.3250	848.7000	3.20	0.0038	Pass
- 30	824.3250	848.7000	3.50	0.0042	Pass	
15%	+ 20	824.3250	848.7000	3.60	0.0043	Pass
-15%	+ 20	824.3250	848.7000	2.70	0.0032	Pass

A.3 Transmitter Output Power Test Result

Test Site	SIP-SR1	Test Engineer	Yoniter Yang
Test Date	2024-04-28	Test Band	WCDMA Band II

Mode	3GPP Subtest	Conducted Power (dBm)			Antenna Gain (dBi)	EIRP (dBm)		
		Channel				Channel		
		Low	Middle	High		Low	Middle	High
WCDMA R99	1	23.28	23.25	23.25	3.87	27.15	27.12	27.12
HSDPA	1	22.15	22.23	22.23	3.87	26.02	26.10	26.10
	2	22.22	22.20	22.19	3.87	26.09	26.07	26.06
	3	21.73	21.71	21.75	3.87	25.60	25.58	25.62
	4	21.73	21.74	21.68	3.87	25.60	25.61	25.55
HSUPA	1	22.19	22.15	22.28	3.87	26.06	26.02	26.15
	2	20.22	20.29	20.24	3.87	24.09	24.16	24.11
	3	21.19	21.27	21.23	3.87	25.06	25.14	25.10
	4	20.20	20.27	20.25	3.87	24.07	24.14	24.12
	5	22.22	22.23	22.29	3.87	26.09	26.10	26.16
Limit	33.01dBm							

Note: The EIRP (dBm) = Output Power (dBm) + Antenna Gain (dBi).

Test Site	SIP-SR1	Test Engineer	Yoniter Yang
Test Date	2024-04-28	Test Band	WCDMA Band IV

Mode	3GPP Subtest	Conducted Power (dBm)			Antenna Gain (dBi)	EIRP (dBm)		
		Channel				Channel		
		Low	Middle	High		Low	Middle	High
WCDMA R99	1	23.23	23.26	23.29	3.91	27.14	27.17	27.20
HSDPA	1	22.28	22.26	22.31	3.91	26.19	26.17	26.22
	2	22.25	22.27	22.28	3.91	26.16	26.18	26.19
	3	21.71	21.73	21.77	3.91	25.62	25.64	25.68
	4	21.74	21.74	21.77	3.91	25.65	25.65	25.68
HSUPA	1	22.29	22.33	22.30	3.91	26.20	26.24	26.21
	2	20.05	20.24	20.24	3.91	23.96	24.15	24.15
	3	21.29	21.27	21.05	3.91	25.20	25.18	24.96
	4	20.15	20.20	20.17	3.91	24.06	24.11	24.08
	5	22.23	22.24	22.19	3.91	26.14	26.15	26.10
Limit	30.00dBm							
Note: The EIRP (dBm) = Output Power (dBm) + Antenna Gain (dBi).								

Test Site	SIP-SR1	Test Engineer	Yoniter Yang
Test Date	2024-04-28	Test Band	WCDMA Band V

Mode	3GPP Subtest	Conducted Power (dBm)			Antenna Gain (dBi)	ERP (dBm)		
		Channel				Channel		
		Low	Middle	High		Low	Middle	High
WCDMA R99	1	23.43	23.41	23.28	3.32	24.60	24.58	24.45
HSDPA	1	22.41	22.42	22.30	3.32	23.58	23.59	23.47
	2	22.42	22.38	22.29	3.32	23.59	23.55	23.46
	3	21.89	21.93	21.78	3.32	23.06	23.10	22.95
	4	21.92	21.90	21.76	3.32	23.09	23.07	22.93
HSUPA	1	22.40	22.39	22.35	3.32	23.57	23.56	23.52
	2	20.49	20.44	20.28	3.32	21.66	21.61	21.45
	3	21.31	21.39	21.26	3.32	22.48	22.56	22.43
	4	20.42	20.47	20.23	3.32	21.59	21.64	21.40
	5	22.33	22.30	22.34	3.32	23.50	23.47	23.51
Limit	38.45dBm							

Note: The ERP (dBm) = Output Power (dBm) + Antenna Gain (dBi) – 2.15.

A.4 Peak to Average Radio Test Result

Test Site	SIP-SR1	Test Engineer	Yoniter Yang
Test Date	2024-05-17	Test Band	WCDMA Band II, IV, V

Frequency (MHz)	Channel Bandwidth (MHz)	Peak to Average Ratio (dB)	Limit (dB)	Result
1852.4	5	3.00	≤ 13.00	Pass
1880.0	5	2.95	≤ 13.00	Pass
1907.6	5	3.08	≤ 13.00	Pass
1712.4	5	3.30	≤ 13.00	Pass
1732.4	5	3.20	≤ 13.00	Pass
1752.6	5	3.36	≤ 13.00	Pass
826.4	5	3.03	≤ 13.00	Pass
836.4	5	3.03	≤ 13.00	Pass
846.6	5	3.11	≤ 13.00	Pass

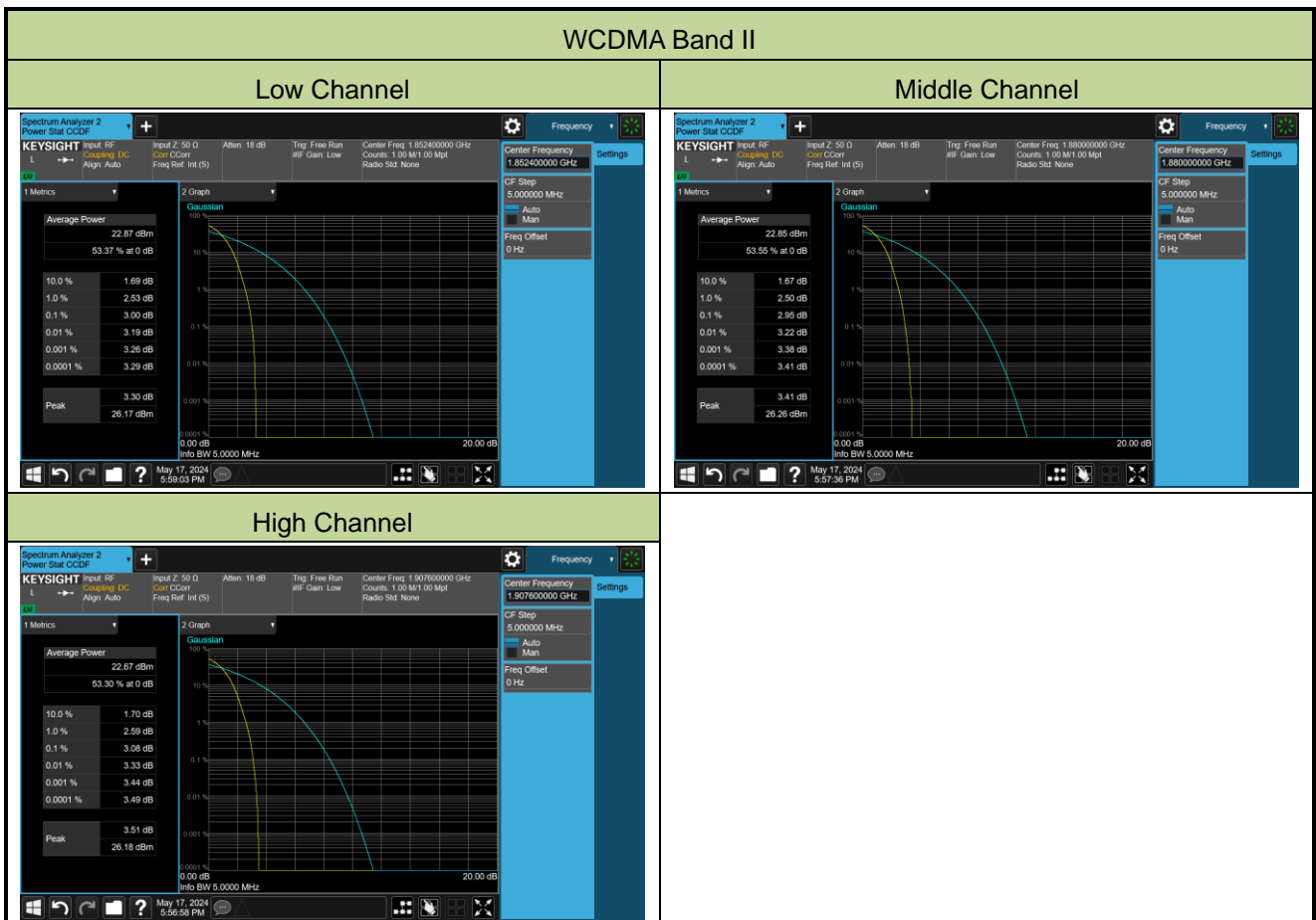

WCDMA Band IV

Low Channel

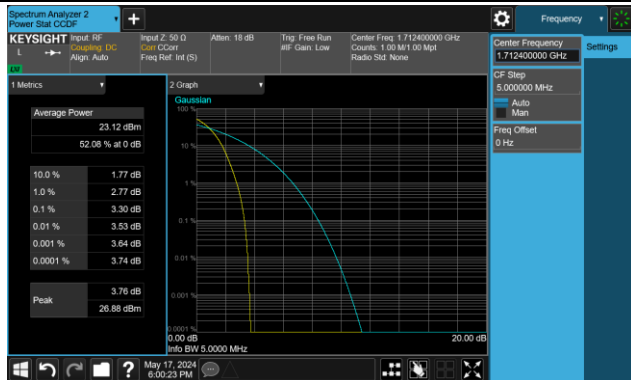

Middle Channel

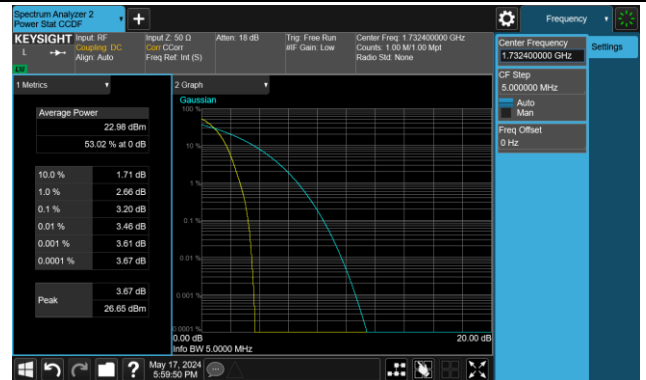

High Channel

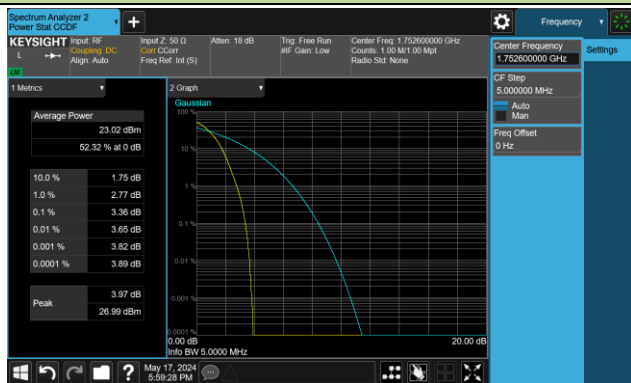

WCDMA Band V

Low Channel

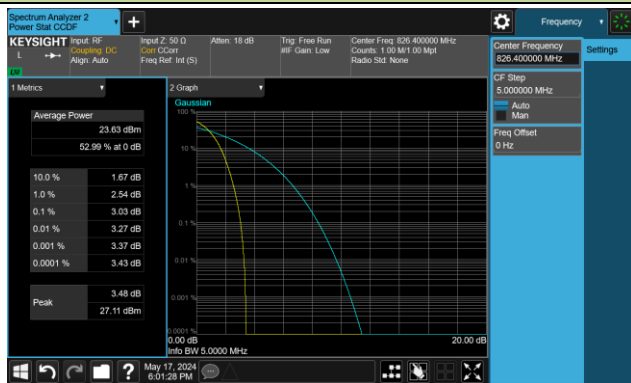

Middle Channel

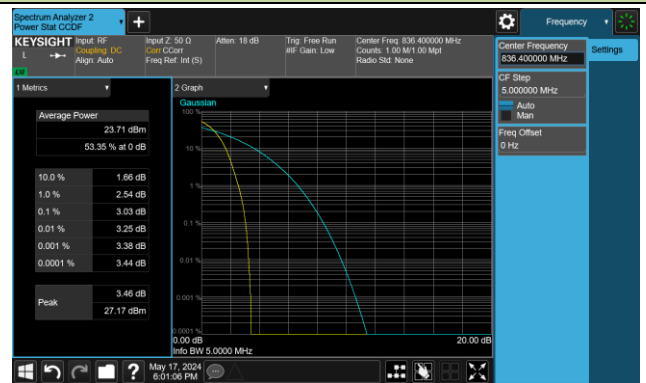

High Channel

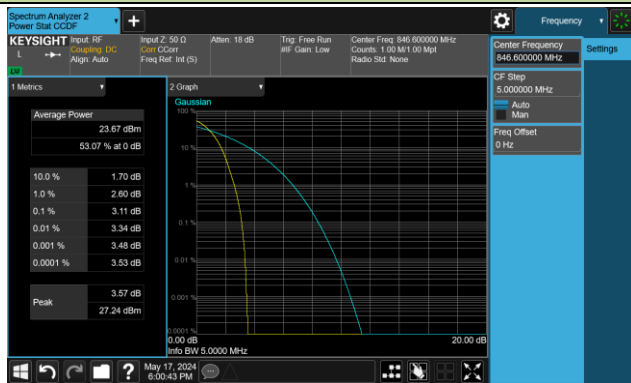

A.5 Transmitter unwanted emissions (band-edge) Test Result

Test Site	SIP-SR1	Test Engineer	Yoniter Yang
Test Date	2024-05-18	Test Band	WCDMA Band II, IV, V

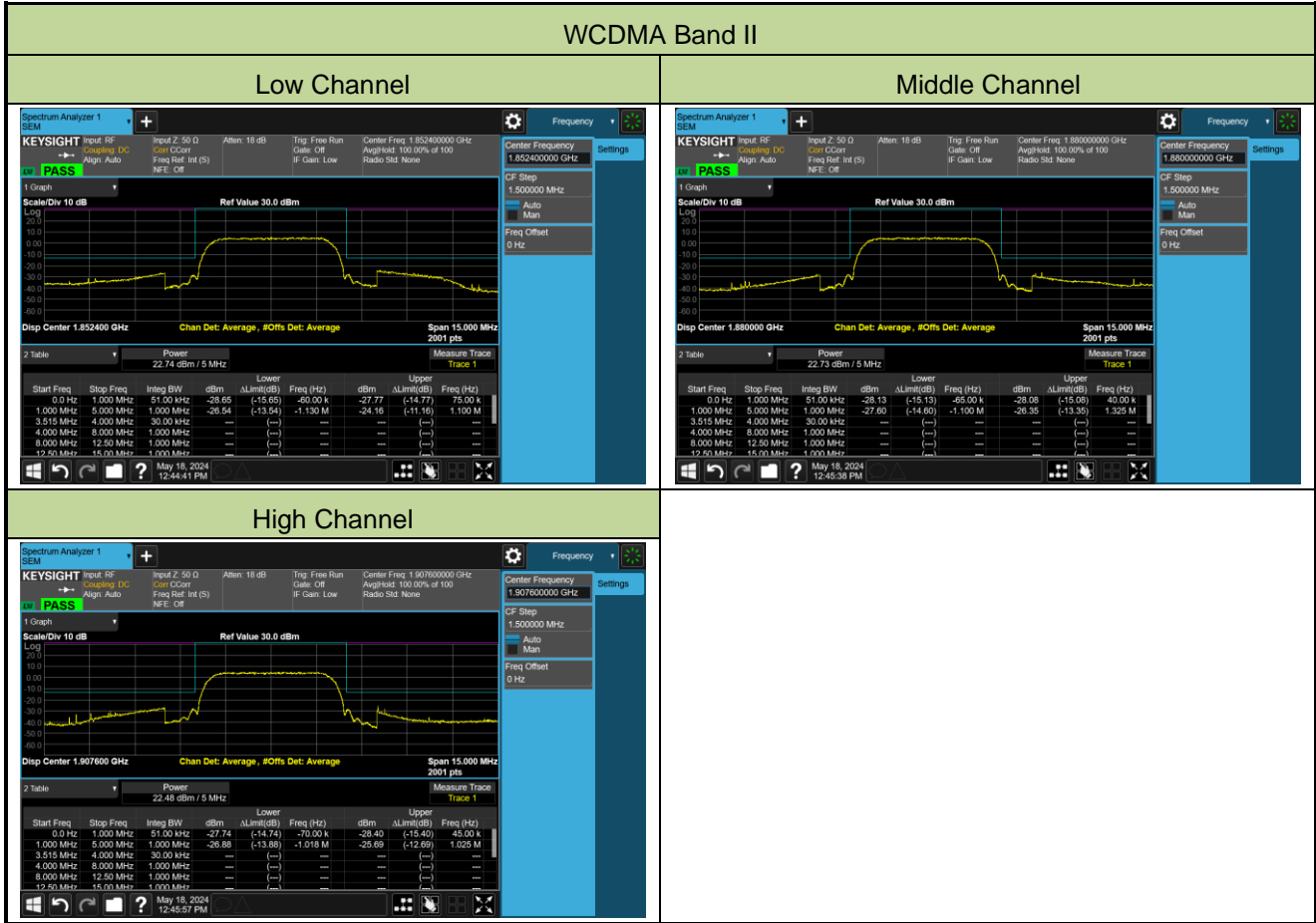

WCDMA Band IV

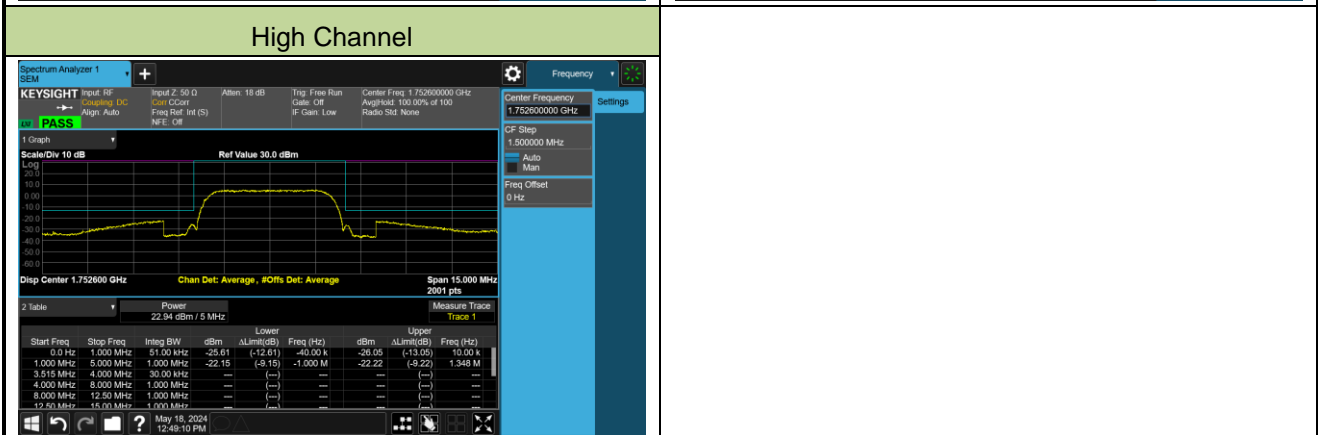
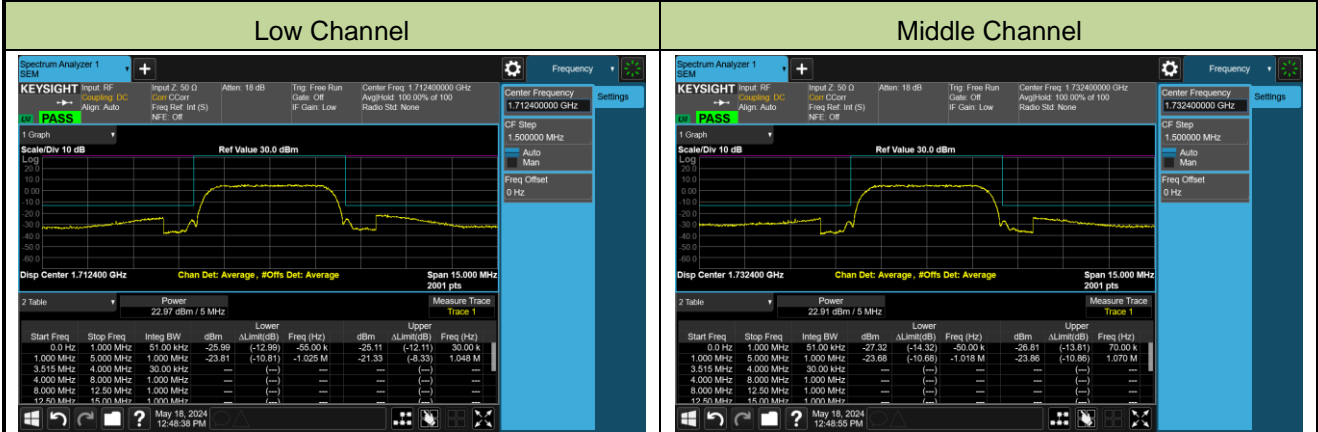

WCDMA Band V

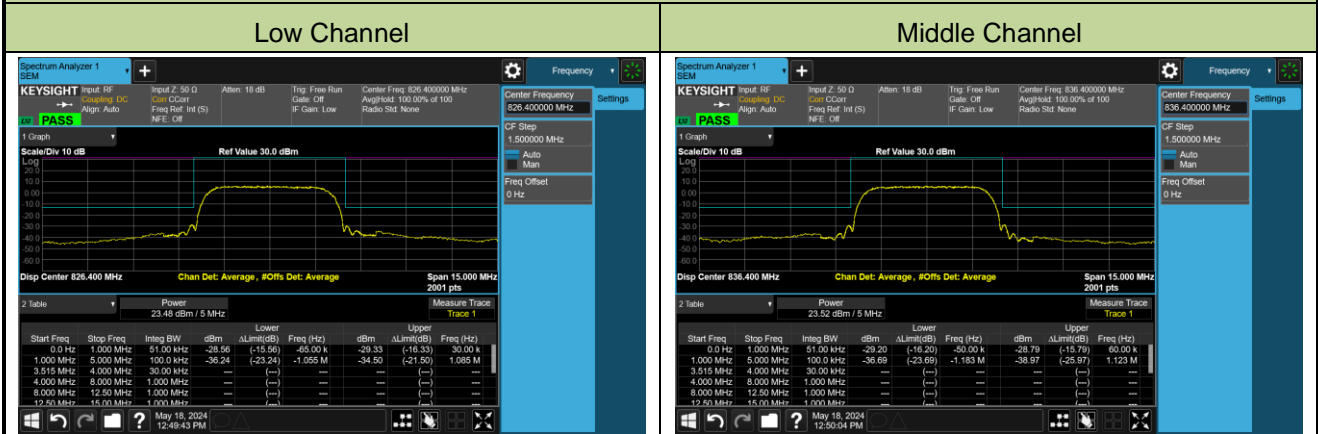

A.6 Transmitter unwanted emissions (spurious) Test Result

Test Site	SIP-SR1	Test Engineer	Yoniter Yang
Test Date	2024-05-25	Test Band	WCDMA Band II, IV, V

Mode	Frequency (MHz)	Frequency Range (MHz)	Max Spurious Emissions (dBm)	Limit (dBm)	Result
WCDMA Band II	1852.4	30 ~ 1000	-49.70	≤ -13.00	Pass
		1000 ~ 20000	-19.24	≤ -13.00	Pass
	1880.0	30 ~ 1000	-48.94	≤ -13.00	Pass
		1000 ~ 20000	-20.70	≤ -13.00	Pass
	1907.6	30 ~ 1000	-49.82	≤ -13.00	Pass
		1000 ~ 20000	-23.36	≤ -13.00	Pass
WCDMA Band IV	1712.4	30 ~ 1000	-49.53	≤ -13.00	Pass
		1000 ~ 18000	-21.26	≤ -13.00	Pass
	1732.4	30 ~ 1000	-49.94	≤ -13.00	Pass
		1000 ~ 18000	-18.08	≤ -13.00	Pass
	1752.6	30 ~ 1000	-50.17	≤ -13.00	Pass
		1000 ~ 18000	-24.01	≤ -13.00	Pass
WCDMA Band V	826.4	30 ~ 9000	-31.66	≤ -13.00	Pass
	836.4	30 ~ 9000	-32.80	≤ -13.00	Pass
	846.6	30 ~ 9000	-36.05	≤ -13.00	Pass

Note: The amplitude of Conducted Spurious emissions (frequency range from 9kHz to 30MHz) is that proximity to ambient noise, which also are attenuated more than 20 dB below the permissible value.

WCDMA Band II

Low Channel 30 ~ 1000MHz

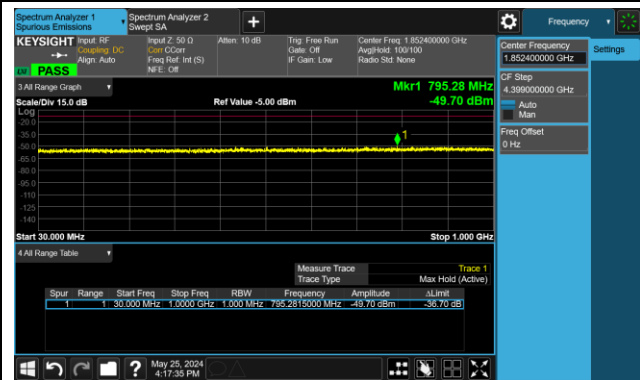

Low Channel 1000 ~ 20000MHz

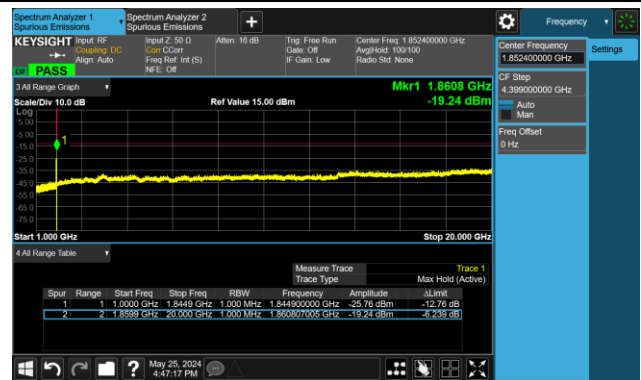

Middle Channel 30 ~ 1000MHz

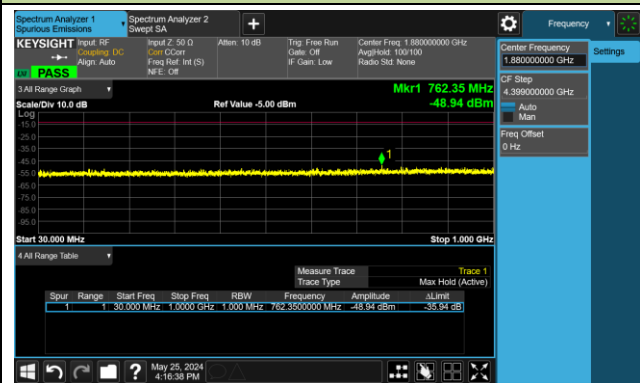

Middle Channel 1000 ~ 20000MHz

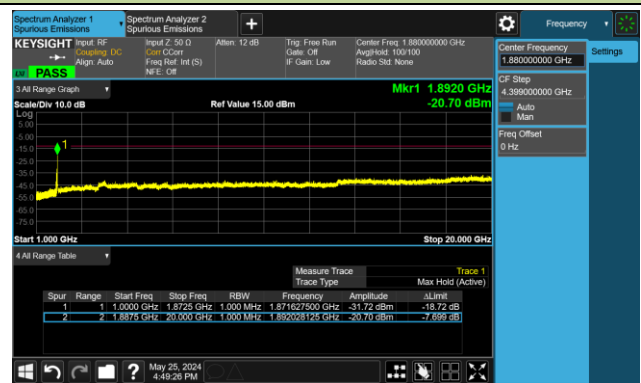

High Channel 30 ~ 1000MHz

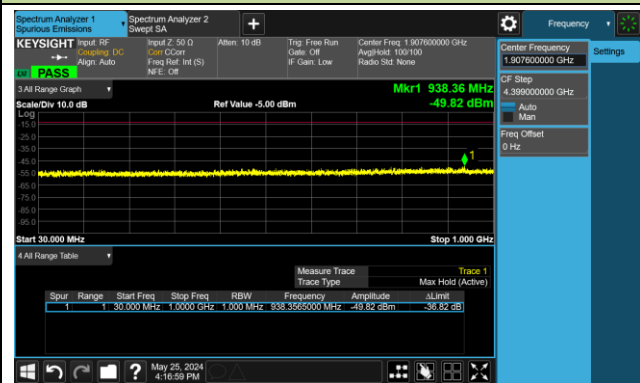

High Channel 1000 ~ 20000MHz

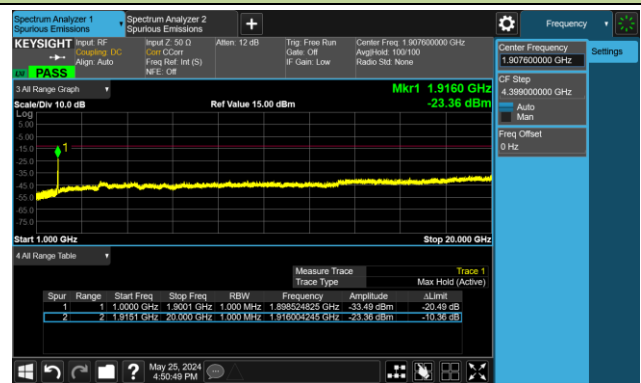

WCDMA Band IV

Low Channel 30 ~ 1000MHz

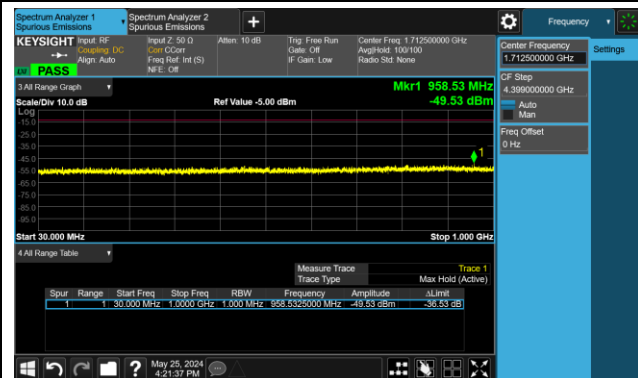

Low Channel 1000 ~ 20000MHz

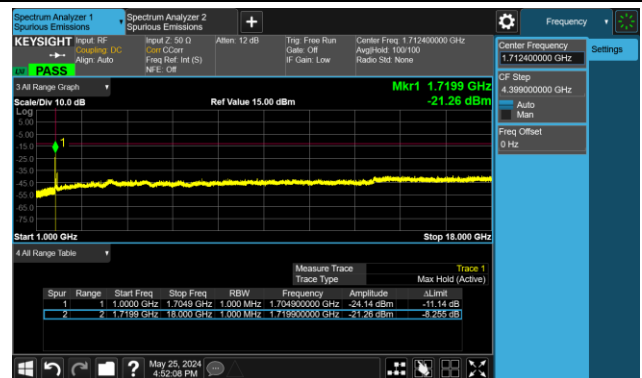

Middle Channel 30 ~ 1000MHz

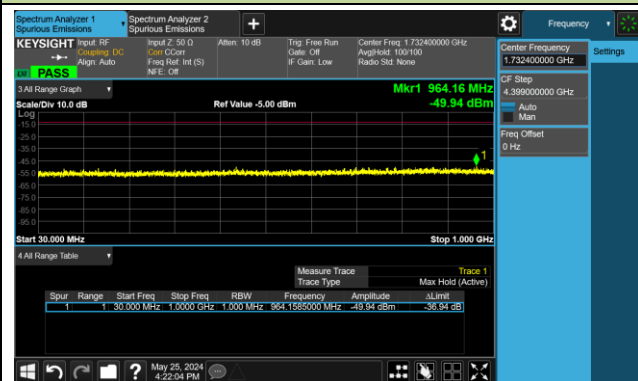

Middle Channel 1000 ~ 20000MHz

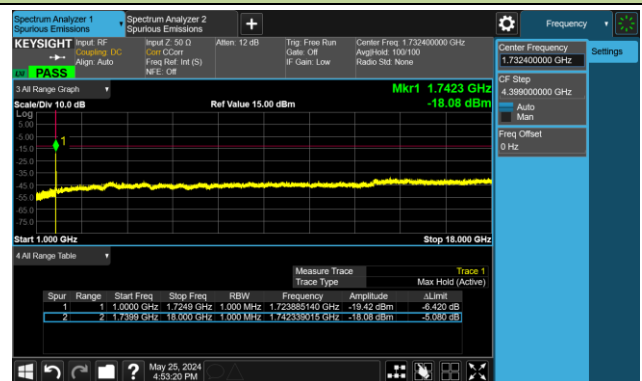

High Channel 30 ~ 1000MHz

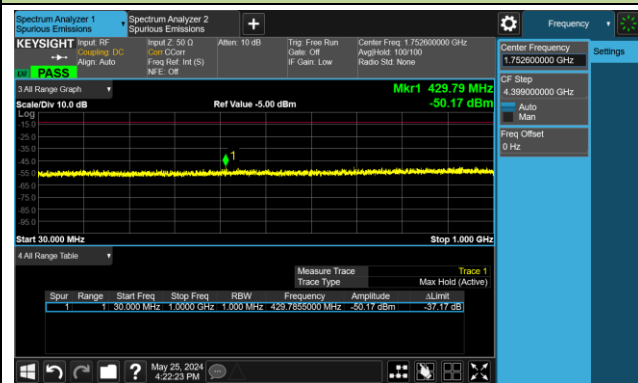

High Channel 1000 ~ 20000MHz

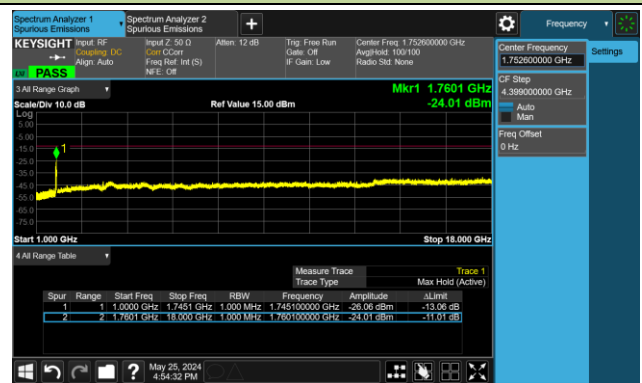

WCDMA Band V

Low Channel 30 ~ 9000MHz

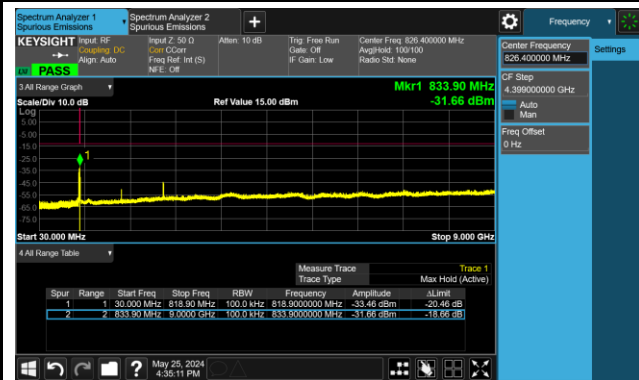

Middle Channel 30 ~ 9000MHz

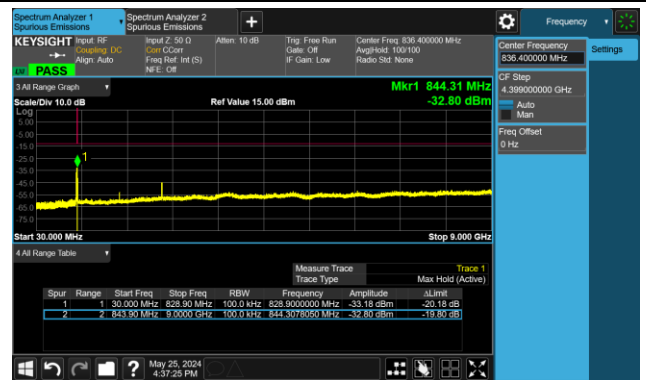

High Channel 30 ~ 9000MHz

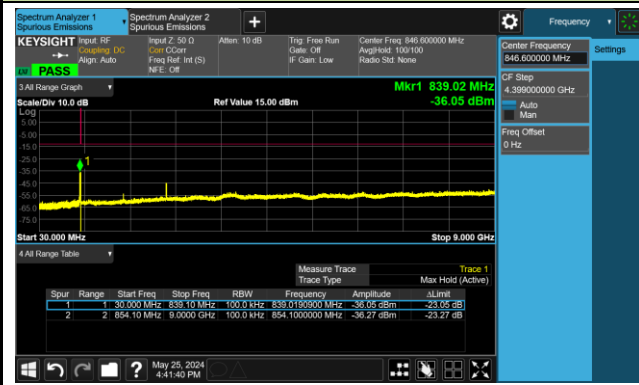

A.7 Radiated Spurious Emissions Test Result

Test Site	SIP-AC1	Test Engineer	Oliver Cheng
Test Date	2024-05-13 ~ 2024-05-14	Test Band	WCDMA Band II

Frequency (MHz)	Reading Level (dB μ V)	Factor (dB/m)	Measure Level (dB μ V/m)	Limit (dB μ V/m)	Margin (dB)	Detector	Polarization
Low Channel							
50.4	-4.2	18.0	13.8	82.3	-68.5	Quasi-Peak	Horizontal
920.9	-7.3	29.6	22.3	82.3	-60.0	Quasi-Peak	Horizontal
38.7	7.1	17.2	24.3	82.3	-58.0	Quasi-Peak	Horizontal
820.1	-9.4	28.3	18.9	82.3	-63.4	Quasi-Peak	Horizontal
3703.0	44.6	1.4	46.0	82.3	-36.3	Peak	Vertical
17932.0	33.1	23.4	56.5	82.3	-25.8	Peak	Vertical
3788.0	38.5	2.4	40.9	82.3	-41.4	Peak	Vertical
17243.5	32.5	21.9	54.4	82.3	-27.9	Peak	Vertical
Middle Channel							
54.7	-6.5	17.8	11.3	82.3	-71.0	Quasi-Peak	Horizontal
897.2	-7.3	29.6	22.3	82.3	-60.0	Quasi-Peak	Horizontal
38.7	8.2	17.2	25.4	82.3	-56.9	Quasi-Peak	Horizontal
808.4	-7.3	28.2	20.9	82.3	-61.4	Quasi-Peak	Horizontal
3762.5	43.7	2.2	45.9	82.3	-36.4	Peak	Vertical
17592.0	32.7	22.8	55.5	82.3	-26.8	Peak	Vertical
4196.0	38.5	3.3	41.8	82.3	-40.5	Peak	Vertical
17260.5	33.8	21.8	55.6	82.3	-26.7	Peak	Vertical
High Channel							
52.3	-5.2	17.9	12.7	82.3	-69.6	Quasi-Peak	Horizontal
829.3	-3.3	28.5	25.2	82.3	-57.1	Quasi-Peak	Horizontal
39.2	7.9	17.3	25.2	82.3	-57.1	Quasi-Peak	Horizontal
929.2	-3.2	29.7	26.5	82.3	-55.8	Quasi-Peak	Horizontal
3813.5	42.8	2.6	45.4	82.3	-36.9	Peak	Vertical
9534.0	40.3	9.7	50.0	82.3	-32.3	Peak	Vertical
4884.5	37.5	5.1	42.6	82.3	-39.7	Peak	Vertical
17456.0	32.5	22.0	54.5	82.3	-27.8	Peak	Vertical

Note1: Measure Level (dB μ V/m) = Reading Level (dB μ V) + Factor (dB/m)

Factor (dB/m) = Cable Loss (dB) + Antenna Factor (dB/m).

Note2: The peak-detection value will always be equal to or greater than average-detection value. In a result, the peak-detection value measured by spectrum analyzer shall represent the worst-case results.

Note 3: The amplitude of Radiated transmitter spurious emissions (Frequency range from 9kHz to 30MHz and above 18GHz) is that proximity to ambient noise, which also are attenuated more than 20 dB below the permissible value. Therefore, the data is not presented in the report.

Test Site	SIP-AC1	Test Engineer	Oliver Cheng
Test Date	2024-05-13 ~ 2024-05-14	Test Band	WCDMA Band IV

Frequency (MHz)	Reading Level (dBμV)	Factor (dB/m)	Measure Level (dBμV/m)	Limit (dBμV/m)	Margin (dB)	Detector	Polarization
Low Channel							
54.3	-8.7	17.9	9.2	82.3	-73.1	Quasi-Peak	Horizontal
830.3	-6.8	28.6	21.8	82.3	-60.5	Quasi-Peak	Horizontal
54.7	7.3	17.8	25.1	82.3	-57.2	Quasi-Peak	Horizontal
971.4	-8.0	29.9	21.9	82.3	-60.4	Quasi-Peak	Horizontal
10273.5	42.4	11.6	54.0	82.3	-28.3	Peak	Vertical
17218.0	33.3	21.8	55.1	82.3	-27.2	Peak	Vertical
14787.0	36.0	18.4	54.4	82.3	-27.9	Peak	Vertical
17243.5	33.9	21.9	55.8	82.3	-26.5	Peak	Vertical
Middle Channel							
54.7	-6.3	17.8	11.5	82.3	-70.8	Quasi-Peak	Horizontal
955.9	-6.3	29.8	23.5	82.3	-58.8	Quasi-Peak	Horizontal
39.2	8.2	17.3	25.5	82.3	-56.8	Quasi-Peak	Horizontal
947.6	-8.9	29.7	20.8	82.3	-61.5	Quasi-Peak	Horizontal
10435.0	40.1	11.1	51.2	82.3	-31.1	Peak	Vertical
17592.0	32.5	22.8	55.3	82.3	-27.0	Peak	Vertical
4349.0	38.4	3.8	42.2	82.3	-40.1	Peak	Vertical
17541.0	33.0	21.5	54.5	82.3	-27.8	Peak	Vertical
High Channel							
52.3	-2.9	17.9	15.0	82.3	-67.3	Quasi-Peak	Horizontal
832.2	-3.6	28.6	25.0	82.3	-57.3	Quasi-Peak	Horizontal
67.3	6.5	16.2	22.7	82.3	-59.6	Quasi-Peak	Horizontal
105.2	6.1	14.2	20.3	82.3	-62.0	Quasi-Peak	Horizontal
4493.5	38.9	3.8	42.7	82.3	-39.6	Peak	Vertical
17592.0	31.7	22.8	54.5	82.3	-27.8	Peak	Vertical
4961.0	36.8	5.1	41.9	82.3	-40.4	Peak	Vertical
17235.0	33.3	21.9	55.2	82.3	-27.1	Peak	Vertical

Note1: Measure Level (dBμV/m) = Reading Level (dBμV) + Factor (dB/m)

Factor (dB/m) = Cable Loss (dB) + Antenna Factor (dB/m).

Note2: The peak-detection value will always be equal to or greater than average-detection value. In a result, the peak-detection value measured by spectrum analyzer shall represent the worst-case results.

Note 3: The amplitude of Radiated transmitter spurious emissions (Frequency range from 9kHz to 30MHz and

above 18GHz) is that proximity to ambient noise, which also are attenuated more than 20 dB below the permissible value. Therefore, the data is not presented in the report.

Test Site	SIP-AC1	Test Engineer	Oliver Cheng
Test Date	2024-05-13 ~ 2024-05-14	Test Band	WCDMA Band V

Frequency (MHz)	Reading Level (dB μ V)	Factor (dB/m)	Measure Level (dB μ V/m)	Limit (dB μ V/m)	Margin (dB)	Detector	Polarization
Low Channel							
53.8	-2.1	17.9	15.8	82.3	-66.5	Quasi-Peak	Horizontal
947.1	-7.3	29.8	22.5	82.3	-59.8	Quasi-Peak	Horizontal
105.2	4.3	14.2	18.5	82.3	-63.8	Quasi-Peak	Horizontal
988.8	-7.2	29.6	22.4	82.3	-59.9	Quasi-Peak	Horizontal
1773.5	46.9	-7.1	39.8	82.3	-42.5	Peak	Vertical
15382.0	34.6	19.5	54.1	82.3	-28.2	Peak	Vertical
1314.5	45.5	-8.9	36.6	82.3	-45.7	Peak	Vertical
15254.5	33.9	19.7	53.6	82.3	-28.7	Peak	Vertical
Middle Channel							
55.2	-7.1	17.8	10.7	82.3	-71.6	Quasi-Peak	Horizontal
971.4	-9.8	29.9	20.1	82.3	-62.2	Quasi-Peak	Horizontal
39.2	3.5	17.3	20.8	82.3	-61.5	Quasi-Peak	Horizontal
936.5	7.5	29.7	37.2	82.3	-45.1	Quasi-Peak	Horizontal
1280.5	45.7	-9.1	36.6	82.3	-45.7	Peak	Vertical
15348.0	34.1	19.8	53.9	82.3	-28.4	Peak	Vertical
1323.0	46.0	-8.8	37.2	82.3	-45.1	Peak	Vertical
18000.0	32.2	22.5	54.7	82.3	-27.6	Peak	Vertical
High Channel							
49.4	-2.2	18.0	15.8	82.3	-66.5	Quasi-Peak	Horizontal
898.6	-8.6	29.7	21.1	82.3	-61.2	Quasi-Peak	Horizontal
54.7	8.9	17.8	26.7	82.3	-55.6	Quasi-Peak	Horizontal
973.8	-8.6	29.7	21.1	82.3	-61.2	Quasi-Peak	Horizontal
1748.0	44.5	-7.2	37.3	82.3	-45.0	Peak	Vertical
15118.5	34.5	19.2	53.7	82.3	-28.6	Peak	Vertical
1731.0	48.8	-7.2	41.6	82.3	-40.7	Peak	Vertical
15135.5	34.5	19.2	53.7	82.3	-28.6	Peak	Vertical

Note1: Measure Level (dB μ V/m) = Reading Level (dB μ V) + Factor (dB/m)

Factor (dB/m) = Cable Loss (dB) + Antenna Factor (dB/m).

Note2: The peak-detection value will always be equal to or greater than average-detection value. In a result, the peak-detection value measured by spectrum analyzer shall represent the worst-case results.

Note 3: The amplitude of Radiated transmitter spurious emissions (Frequency range from 9kHz to 30MHz) is

that proximity to ambient noise, which also are attenuated more than 20 dB below the permissible value. Therefore, the data is not presented in the report.

Appendix B - Test Setup Photograph

Refer to "2404RSU035-UT" file.

Appendix C - EUT Photograph

Refer to "2404RSU035-UE" file.