

RF MEASUREMENT REPORT

FCC ID: 2BEY3LCUR57WWDA
Applicant: NETPRISMA INC.
Product: LTE-A Cat 16 M.2 Module
Model No.: LCUR57-WWD
Brand Name: Vrileg
FCC Rule(s): Part 27 Subpart D
Result: Complies
Received Date: 2024-04-22
Test Date: 2024-05-05 ~ 2024-05-27

Reviewed By:

Sunny Sun

Approved By:

Robin Wu



The test results relate only to the samples tested.

This equipment has been shown to be capable of compliance with the applicable technical standards as indicated in the measurement report and was tested in accordance with the measurement procedures specified in ANSI C63.26-2015. Test results reported herein relate only to the item(s) tested.

The test report shall not be reproduced except in full without the written approval of MRT Technology (Suzhou) Co., Ltd.

Revision History

Report No.	Version	Description	Issue Date	Note
2404RSU035-U5	V01	Initial Report	2024-06-07	Valid

CONTENTS

Description	Page
1. General Information	5
1.1. Applicant	5
1.2. Manufacturer.....	5
1.3. Testing Facility	5
1.4. Product Information	6
1.5. Radio Specification under Test.....	6
1.6. Description of Available Antennas	7
1.7. Test Methodology	7
2. Test Configuration	8
2.1. Test System Connection Diagram	8
2.2. Test Environment Condition.....	8
3. Measuring Instrument	9
4. Decision Rules and Measurement Uncertainty	11
4.1. Decision Rules.....	11
4.2. Measurement Uncertainty	11
5. Test Result.....	12
5.1. Summary	12
5.2. Occupied Bandwidth Measurement	13
5.2.1. Test Limit.....	13
5.2.2. Test Procedure	13
5.2.3. Test Setting	13
5.2.4. Test Setup.....	13
5.2.5. Test Result	13
5.3. Frequency Stability Measurement	14
5.3.1. Test Limit.....	14
5.3.2. Test Procedure	14
5.3.3. Test Setting	14
5.3.4. Test Setup.....	15
5.3.5. Test Result	15
5.4. Transmitter Output Power Measurement	16
5.4.1. Test Limit.....	16
5.4.2. Test Procedure	16
5.4.3. Test Setting	16
5.4.4. Test Setup.....	17

5.4.5.	Test Result	17
5.5.	Transmitter unwanted emissions (band-edge) Measurement	18
5.5.1.	Test Limit.....	18
5.5.2.	Test Procedure	18
5.5.3.	Test Setting	18
5.5.4.	Test Setup.....	19
5.5.5.	Test Result	19
5.6.	Transmitter unwanted emissions (spurious) Measurement.....	20
5.6.1.	Test Limit.....	20
5.6.2.	Test Procedure	20
5.6.3.	Test Setting	20
5.6.4.	Test Setup.....	21
5.6.5.	Test Result	21
5.7.	Radiated Spurious Emissions Measurement	22
5.7.1.	Test Limit.....	22
5.7.2.	Test Procedure	22
5.7.3.	Test Setting	22
5.7.4.	Test Setup.....	23
5.7.5.	Test Result	23
Appendix A - Test Result.....		24
A.1	Occupied Bandwidth Test Result.....	24
A.2	Frequency Stability Test Result	28
A.3	Transmitter Output Power Test Result.....	29
A.4	Transmitter unwanted emissions (band-edge) Test Result	32
A.5	Transmitter unwanted emissions (spurious) Test Result	38
A.6	Radiated Spurious Emissions Test Result.....	41
Appendix B - Test Setup Photograph		43
Appendix C - EUT Photograph		44

1. General Information

1.1. Applicant

NETPRISMA INC.

1301 6TH AVE, SEATTLE, WA, 98101-2304, UNITED STATES

1.2. Manufacturer

NETPRISMA INC.

1301 6TH AVE, SEATTLE, WA, 98101-2304, UNITED STATES

1.3. Testing Facility

<input checked="" type="checkbox"/>	Test Site – MRT Suzhou Laboratory
	Laboratory Location (Suzhou - Wuzhong) D8 Building, No.2 Tian'edang Rd., Wuzhong Economic Development Zone, Suzhou, China
	Laboratory Location (Suzhou - SIP) 4b Building, Liando U Valley, No.200 Xingpu Rd., Shengpu Town, Suzhou Industrial Park, China
	Laboratory Accreditations
	A2LA: 3628.01 CNAS: L10551 FCC: CN1166 ISED: CN0001 VCCI: <input type="checkbox"/> R-20025 <input type="checkbox"/> G-20034 <input type="checkbox"/> C-20020 <input type="checkbox"/> T-20020 <input type="checkbox"/>R-20141 <input type="checkbox"/>G-20134 <input type="checkbox"/>C-20103 <input type="checkbox"/>T-20104
<input type="checkbox"/>	Test Site – MRT Shenzhen Laboratory
	Laboratory Location (Shenzhen) 1G, Building A, Junxiangda Building, Zhongshanyuan Road West, Nanshan District, Shenzhen, China
	Laboratory Accreditations
	A2LA: 3628.02 CNAS: L10551 FCC: CN1284 ISED: CN0105
<input type="checkbox"/>	Test Site – MRT Taiwan Laboratory
	Laboratory Location (Taiwan) No. 38, Fuxing 2nd Rd., Guishan Dist., Taoyuan City 333, Taiwan (R.O.C.)
	Laboratory Accreditations
	TAF: 3261 FCC: 291082, TW3261 ISED: TW3261

1.4. Product Information

Product Name	LTE-A Cat 16 M.2 Module
Model No.	LCUR57-WWD
Brand Name	Vrileg
Serial No.	D1C24CG1D000013 (Conducted) D1C24CG1D000108 (Radiated)
3GPP Specification	WCDMA Band II/IV/V LTE Band 2, 4, 5, 7, 12, 13, 14, 25, 26, 30, 38, 41, 42, 43, 48, 66
Operating Temperature Range	-25 ~ 75 °C
Supply Voltage Rating	3.135 – 4.4Vdc, typical 3.7Vdc
Antenna Specification	Refer to Section 1.6
Remark: The information of EUT was provided by the manufacturer, and the accuracy of the information shall be the responsibility of the manufacturer.	

1.5. Radio Specification under Test

E-UTRA Specification	
TX Frequency Range	Band 30: 2305 ~ 2315 MHz
RX Frequency Range	Band 30: 2350 ~ 2360 MHz
Support Bandwidth	5MHz, 10MHz
Support Power Class	PC3
Modulation	UL up to 64QAM & DL up to 256QAM

1.6. Description of Available Antennas

Technology	Frequency Range (MHz)	Antenna Type	MaxPeak Gain (dBi)
LTE Band 30	2305 ~ 2315	PIFA	0.98

Note 1: All antenna information (Antenna type and Peak Gain) is provided by the manufacturer.
Note 2: The typical antennas used to calculate the ERP (EIRP).

1.7. Test Methodology

According to the specifications of the manufacturer, the EUT must comply with the requirements of the following standards:

- ANSI C63.26:2015
- FCC CFR 47 Part 27
- FCC KDB 971168 D01 v03r01: Power Meas License Digital Systems
- FCC KDB 971168 D02 v02r01: Misc Rev Approv License Devices
- FCC KDB 412172 D01 v01r01: Determining ERP and EIRP

2. Test Configuration

2.1. Test System Connection Diagram

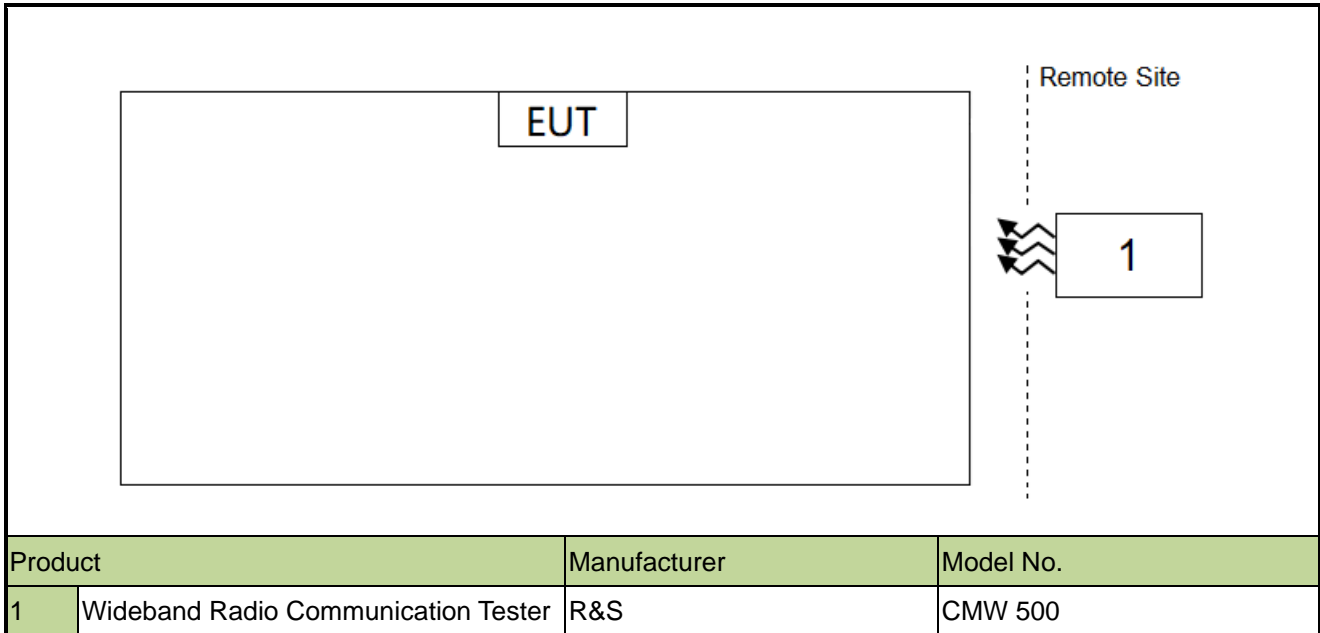

2.2. Test Environment Condition

Ambient Temperature	15 ~ 35°C
Relative Humidity	20% ~ 75%RH

3. Measuring Instrument

Instrument	Manufacturer	Model No.	Asset No.	Cali. Interval	Cali. Due Date	Test Site
Communication Tester	R&S	CMW500	MRTSUE06243	1 year	2024-09-27	SIP-SR1
Thermohygrometer	testo	622	MRTSUE06629	1 year	2024-12-21	SIP-SR1
Communication Tester	R&S	CMW500	MRTSUE06881	1 year	2024-05-09	SIP-SR1
				1 year	2025-05-08	SIP-SR1
Temperature Chamber	BAOYT	BYG-80CL	MRTSUE06932	1 year	2025-02-03	SIP-SR1
Shielding Room	MIX-BEP	SIP-SR1	MRTSUE06948	N/A	N/A	SIP-SR1
Directional Coupler	MVE	MVE4912-10	MRTSUE07052	1 year	2024-08-24	SIP
Attenuator	MVE	MVE2213	MRTSUE11111	1 year	2024-08-02	SIP
Signal Analyzer	Keysight	N9010B	MRTSUE07028	1 year	2024-10-23	SIP-SR1
Directional Coupler	MVE	MVE4912-10	MRTSUE07052	1 year	2024-08-24	SIP
Communication Tester	R&S	CMW500	MRTSUE06108	1 year	2024-10-23	WZ-SR6
Thermohygrometer	testo	608-H1	MRTSUE06362	1 year	2025-02-04	WZ-SR6
Shielding Room	HUAMING	WZ-SR6	MRTSUE06443	N/A	N/A	WZ-SR6
Radio Communication Analyzer	Anritsu	MT8821C	MRTSUE06960	1 year	2024-07-06	WZ-SR6
Temperature Chamber	BAOYT	BYH-150CL	MRTSUE06051	1 year	2024-09-27	WZ-TR3
Thermohygrometer	testo	608-H1	MRTSUE11268	1 year	2024-12-14	WZ-TR3
Thermohygrometer	testo	608-H1	MRTSUE06362	1 year	2025-02-04	WZ-SR6
Shielding Room	HUAMING	WZ-SR6	MRTSUE06443	N/A	N/A	WZ-SR6
Signal Analyzer	Keysight	N9020B	MRTSUE06583	1 year	2024-09-27	WZ-SR6
USB Power Sensor	Keysight	U8488A	MRTSUE06958	5 years	2026-07-08	SIP-SR3
Thermohygrometer	testo	608-H1	MRTSUE06616	1 year	2024-10-28	SIP-AC1
Horn Antenna	R&S	HF907	MRTSUE06610	1 year	2024-06-17	SIP-AC1
EMI Test Receiver	R&S	ESR3	MRTSUE06185	1 year	2024-12-17	SIP-AC1
Anechoic Chamber	RIKEN	SIP-AC1	MRTSUE06554	1 year	2024-12-21	SIP-AC1
Signal Analyzer	Keysight	N9010B	MRTSUE06559	1 year	2024-05-09	SIP-AC1
				1 year	2025-05-08	SIP-AC1
Horn Antenna	Schwarzbeck	BBHA 9170	MRTSUE06599	1 year	2024-09-24	SIP-AC1
Preamplifier	EMCI	EMC184045SE	MRTSUE06602	1 year	2024-10-09	SIP-AC1
Loop Antenna	Schwarzbeck	FMZB 1519 B	MRTSUE06937	1 year	2025-01-27	SIP-AC1
Signal Analyzer	Keysight	N9010B	MRTSUE07028	1 year	2024-10-23	SIP-AC1
Active Loop Antenna	Schwarzbeck	FMZB 1519-60 D	MRTSUE07075	1 year	2024-12-04	SIP-AC1
Cable	HUBER+SUHNER	SF106	MRTSUE06594	1 year	2024-12-21	SIP-AC1
Cable	HUBER+SUHNER	SF106	MRTSUE06874	1 year	2024-12-21	SIP-AC1

Software	Version	Function
EMI Software	V3.0.0	EMI Test Software
Controller_MF 7802BS	1.02	RE Antenna & Turntable
CMWrun	V 1.9.10.20	license 2G & 3G & 4G
UCTS	V 6.23.217.99	license 3G & 4G & 5G
Agilent Power Analyzer/Agilent Power Panel	V R03.09.00	Power

4. Decision Rules and Measurement Uncertainty

4.1. Decision Rules

The Decision Rule is based on Simple Acceptance in accordance with ISO Guide 98-4: 2012 Clause 8.2. (Measurement uncertainty is not taken into account when stating conformity with a specified requirement.)

4.2. Measurement Uncertainty

Where relevant, the following test uncertainty levels have been estimated for tests performed on the EUT as specified in CISPR 16-4-2. This uncertainty represents an expanded uncertainty expressed at approximately the 95% confidence level using a coverage factor of $k = 2$.

Radiated Spurious Emissions
Measurement Uncertainty for a Level of Confidence of 95% ($U=2Uc(y)$): Coaxial: 9kHz~30MHz: 2.61dB Coplanar: 9kHz~30MHz: 2.62dB Horizontal: 30MHz~200MHz: 3.79dB 200MHz~1GHz: 3.91dB 1GHz~40GHz: 4.99dB Vertical: 30MHz~200MHz: 4.06dB 200MHz~1GHz: 5.21dB 1GHz~40GHz: 4.90dB
Conducted Spurious Emissions
Measuring Uncertainty for a Level of Confidence of 95% ($U=2Uc(y)$): 1.47dB
Output Power
Measuring Uncertainty for a Level of Confidence of 95% ($U=2Uc(y)$): 0.66dB
Occupied Bandwidth
Measuring Uncertainty for a Level of Confidence of 95% ($U=2Uc(y)$): 69.28kHz
Frequency Stability
Measuring Uncertainty for a Level of Confidence of 95% ($U=2Uc(y)$): 8.04Hz

5. Test Result

5.1. Summary

FCC Part Section(s)	Test Description	Test Condition	Test Result
2.1049	Occupied Bandwidth	Conducted	Pass
2.1055, 27.54	Frequency Stability		Pass
27.50(a)(3)	Transmitter Output Power		Pass
2.1051, 27.53(a)(4)	Transmitter unwanted emissions (band-edge)		Pass
2.1051, 27.53(a)(4)	Transmitter unwanted emissions (spurious)		
2.1053, 27.53(a)(4)	Transmitter Spurious Emission	Radiated	Pass

Notes:

- 1) The analyzer plots shown in this section were all taken with a correction table loaded into the analyzer. The correction table was used to account for the losses of the cables and attenuators used as part of the system to connect the EUT to the analyzer at all frequencies of interest.
- 2) All supported modulation types were evaluated. The worst-case emission of modulation was selected. Therefore, the Frequency Stability, Transmitter unwanted emissions (band-edge), Transmitter unwanted emissions (spurious), Radiated Spurious Emission were presented worst-case in the test report.
- 3) For radiated emission tests, every axis (X, Y, Z) was also verified. The test results shown in the following sections represent the worst-case emissions.

5.2. Occupied Bandwidth Measurement

5.2.1. Test Limit

The occupied bandwidth, that is the frequency bandwidth such that, below its lower and above its upper frequency limits, the mean powers radiated are each equal to 0.5 percent of the total mean power radiated by a given emission shall be measured.

5.2.2. Test Procedure

ANSI C63.26-2015 - Section 5.4.4

5.2.3. Test Setting

1. Set center frequency to the nominal EUT channel center frequency
2. RBW = The nominal RBW shall be in the range of 1% to 5% of the anticipated OBW
3. VBW $\geq 3 \times$ RBW
4. Detector = Peak
5. Trace mode = max hold
6. Sweep = auto couple
7. Allow the trace to stabilize
8. Use the 99% power bandwidth function of the instrument and report the measured bandwidth.

5.2.4. Test Setup

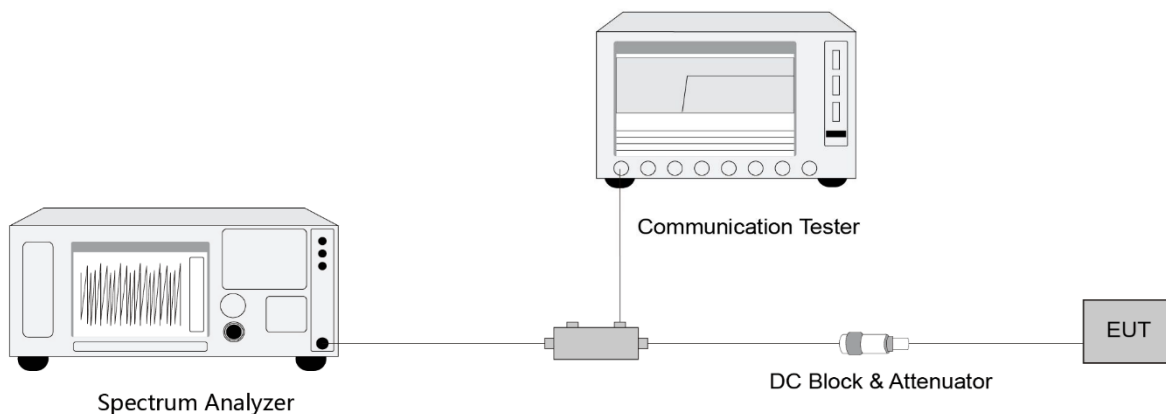

5.2.5. Test Result

Refer to Appendix A.1.

5.3. Frequency Stability Measurement

5.3.1. Test Limit

The frequency stability shall be sufficient to ensure that the fundamental emissions stay within the authorized bands of operation.

5.3.2. Test Procedure

ANSI C63.26-2015 - Section 5.6

5.3.3. Test Setting

1. A reference point shall be established at the applicable unwanted emissions limit using a RBW equal to the RBW required by the unwanted emissions specification of the applicable regulatory standard. These reference points measured using the lowest and highest channel of operation shall be identified as f_L and f_H respectively.
2. Use the frequency error function of the instrument and record the frequency error.
3. Change the temperature of equipment and repeat Steps 2.
4. Change the Voltage of equipment and repeat Steps 2.
5. The frequency error offset determined in the above methods shall be added or subtracted from the values of f_L and f_H and the resulting frequencies must remain within the band

Frequency Stability Under Temperature Variations:

The equipment under test was connected to an external AC or DC power supply and input rated voltage. RF output was connected to a frequency counter or spectrum analyzer via feed through attenuators. The EUT was placed inside the temperature chamber. Set the spectrum analyzer RBW low enough to obtain the desired frequency resolution and measure EUT 20°C operating frequency as reference frequency. Turn EUT off and set the chamber temperature to highest. After the temperature stabilized for approximately 30 minutes recorded the frequency. Repeat step measure with 10°C decreased per stage until the lowest temperature reached.

Frequency Stability Under Voltage Variations:

Set chamber temperature to 20°C. Use a variable AC power supply / DC power source to power the EUT and set the voltage to rated voltage. Set the spectrum analyzer RBW low enough to obtain the desired frequency resolution and recorded the frequency.

Reduce the input voltage to specify extreme voltage variation ($\pm 15\%$) and endpoint, record the maximum frequency change.

5.3.4. Test Setup

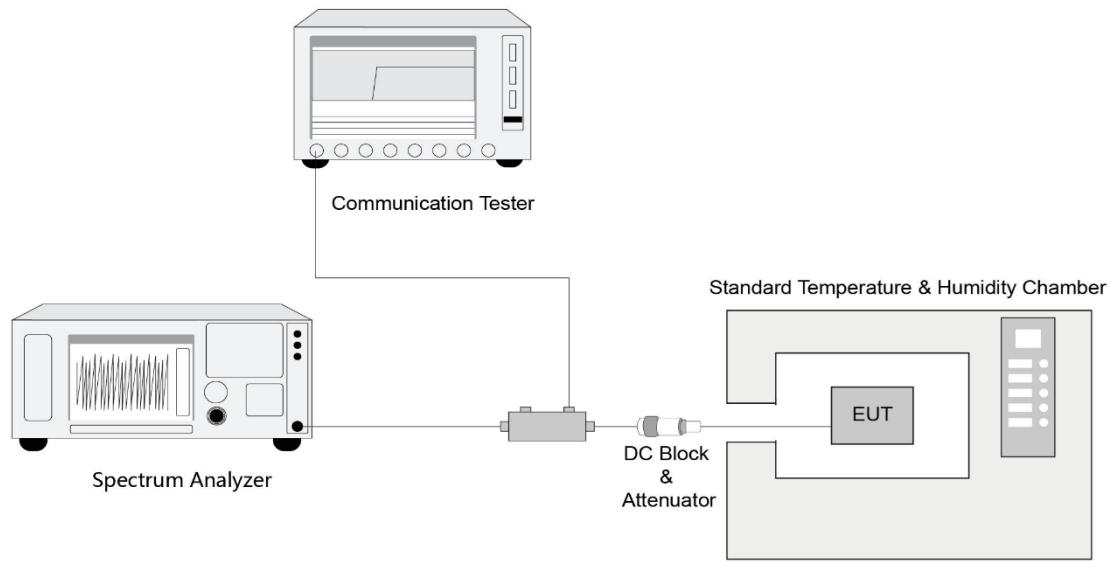

5.3.5. Test Result

Refer to Appendix A.2.

5.4. Transmitter Output Power Measurement

5.4.1. Test Limit

For mobile and portable stations transmitting in the 2305-2315 MHz band or the 2350-2360 MHz band, the average EIRP must not exceed 50 milliwatts within any 1 megahertz of authorized bandwidth, except that for mobile and portable stations compliant with 3GPP LTE standards or another advanced mobile broadband protocol that avoids concentrating energy at the edge of the operating band the average EIRP must not exceed 250 milliwatts within any 5 megahertz of authorized bandwidth but may exceed 50 milliwatts within any 1 megahertz of authorized bandwidth.

5.4.2. Test Procedure

ANSI C63.26-2015 - Section 5.2.4.2 & 5.2.4.4

5.4.3. Test Setting

Average Power Measurement

Average power measurements were performed only when the EUT was transmitting at its maximum power control level using a broadband power meter with a pulse sensor. The power meter implemented triggering and gating capabilities which were set up such that power measurements were recorded only during the ON time of the transmitter.

Average Power Spectral Density Measurement

1. Set span to 2 x to 3 x the OBW;
2. Set RBW = 1% to 5% of the OBW;
3. Set VBW \geq 3 x RBW;
4. Set number of measurement points in sweep \geq 2 x span / RBW;
5. Sweep time set to auto;
6. Detector = power averaging (rms);
7. If the EUT can be configured to transmit continuously, then set the trigger to free run;
8. If the EUT cannot be configured to transmit continuously, then use a sweep trigger with the level set to enable triggering only on full power bursts and configure the EUT to transmit at full power for the entire duration of each sweep.
9. Trace average at least 100 traces in power averaging (rms) mode if sweep is set to auto-couple. To accurately determine the average power over multiple symbols, it can be necessary to increase the number of traces to be averaged above 100 or, if using a manually configured sweep time, increase the

sweep time.

10. Compute power by integrating the spectrum across the specified bandwidth of the signal using the instrument's band or channel power measurement function with band/channel limits set equal to the specified bandwidth band edges. If the instrument does not have a band or channel power function, sum the spectrum levels (in linear power units) at intervals equal to the RBW extending across the entire specified bandwidth of the spectrum.

ERP & EIRP Measurement

The relevant equation for determining the maximum ERP or EIRP from the measured RF output power is given in Equation (1) as follows:

$$\text{ERP or EIRP} = P_{\text{Meas}} + G_T \quad (1)$$

where

ERP or EIRP effective radiated power or equivalent isotropically radiated power, respectively (expressed in the same units as P_{Meas} , e.g., dBm or dBW)

P_{Meas} measured transmitter output power or PSD, in dBm or dBW

G_T gain of the transmitting antenna, in dBd (ERP) or dBi (EIRP)

For devices utilizing multiple antennas, see 6.4 for guidance with respect to determining the effective array transmit antenna gain term to be used in the above equation.

5.4.4. Test Setup

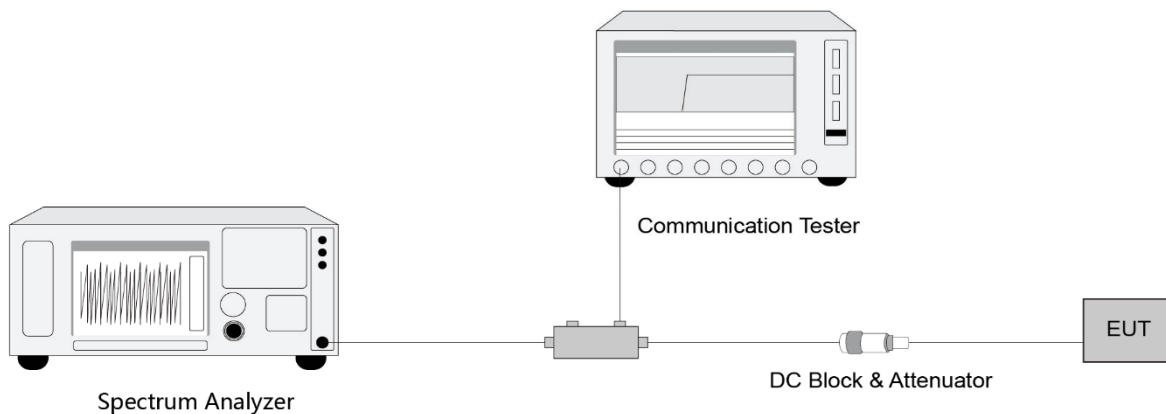

5.4.5. Test Result

Refer to Appendix A.3.

5.5. Transmitter unwanted emissions (band-edge) Measurement

5.5.1. Test Limit

For mobile and portable stations operating in the 2305-2315 MHz and 2350-2360MHz bands:

- (1) By a factor of not less than: $43 + 10 \log (P)$ dB on all frequencies between 2305 and 2320 MHz and on all frequencies between 2345 and 2360 MHz that are outside the licensed band(s) of operation, not less than $55 + 10 \log (P)$ dB on all frequencies between 2320 and 2324 MHz and on all frequencies between 2341 and 2345 MHz, not less than $61 + 10 \log (P)$ dB on all frequencies between 2324 and 2328 MHz and on all frequencies between 2337 and 2341 MHz, and not less than $67 + 10 \log (P)$ dB on all frequencies between 2328 and 2337 MHz;
- (2) By a factor of not less than $43 + 10 \log (P)$ dB on all frequencies between 2300 and 2305 MHz, $55 + 10 \log (P)$ dB on all frequencies between 2296 and 2300 MHz, $61 + 10 \log (P)$ dB on all frequencies between 2292 and 2296 MHz, $67 + 10 \log (P)$ dB on all frequencies between 2288 and 2292 MHz, and $70 + 10 \log (P)$ dB below 2288 MHz;
- (3) By a factor of not less than $43 + 10 \log (P)$ dB on all frequencies between 2360 and 2365 MHz, and not less than $70 + 10 \log (P)$ dB above 2365 MHz.

5.5.2. Test Procedure

ANSI C63.26-2015 - Section 5.7

5.5.3. Test Setting

1. Set the analyzer frequency to Low or High channel
2. RBW = specified resolution bandwidth, for improvement of the accuracy in the measurement of the average power of a noise-like emission, a RBW narrower than the specified reference bandwidth can be used (generally limited to no less than 1% of the frequency block group, provided that a subsequent integration is performed over the full required measurement bandwidth. This integration should be performed using the spectrum analyzer's band power functions.
3. VBW $\geq 3 \cdot$ RBW
4. Sweep time = auto
5. Detector = power averaging (rms)
6. If the EUT can be configured to transmit continuously, then set the trigger to free run
7. If the EUT cannot be configured to transmit continuously, then use a sweep trigger with the level set to enable triggering only on full power bursts and configure the EUT to transmit at full power for the entire

duration of each sweep. Verify that the sweep time is less than or equal to the transmission burst duration.

Time gating can also be used under similar constraints

8. Trace average at least 100 traces in power averaging (rms) mode if sweep is set to auto-couple. To accurately determine the average power over the on and off time of the transmitter, it can be necessary to increase the number of traces to be averaged above 100, or if using a manually configured sweep time, increase the sweep time.
9. Compute the power by integrating the spectrum across the specified resolution bandwidth using the instrument's band or channel power measurement function, with the band/channel limits set equal to the specified resolution bandwidth, when using a measurement bandwidth smaller than the specified bandwidth. Otherwise, Use the peak marker function to determine the maximum amplitude level.

5.5.4. Test Setup

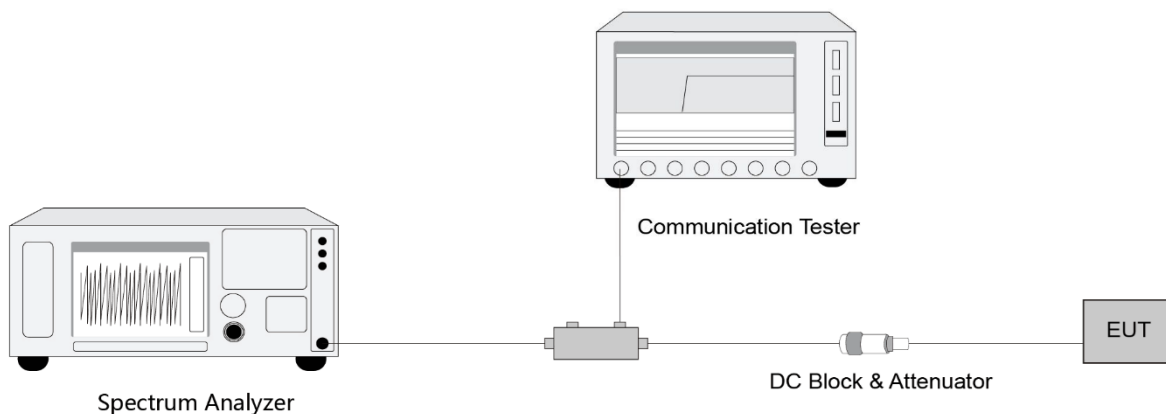

5.5.5. Test Result

Refer to Appendix A.4.

5.6. Transmitter unwanted emissions (spurious) Measurement

5.6.1. Test Limit

The level of the carrier and the various conducted spurious and harmonic frequencies is measured by means of a calibrated spectrum analyzer. The spectrum is scanned from the lowest frequency generated in the equipment up to a frequency including its 10th harmonic. All out of band emissions are measured with a spectrum analyzer connected to the antenna terminal of the EUT while the EUT is operating at its maximum duty cycle, at maximum power, and at the appropriate frequencies. All data rates were investigated to determine the worst-case configuration. All modes of operation were investigated and the worst-case configuration results are reported in this section.

The power of any emission outside of the authorized operating frequency ranges must be lower than the transmitter power (P) by a factor of at least $70 + 10 \log (P)$ dB.

5.6.2. Test Procedure

ANSI C63.26-2015 - Section 5.7

5.6.3. Test Setting

1. Set the analyzer frequency to low, Mid or high channel.
2. RBW = specified resolution bandwidth
3. VBW $\geq 3 \cdot$ RBW
4. Sweep time = auto
5. Detector = power averaging (rms)
6. If the EUT can be configured to transmit continuously, then set the trigger to free run
7. If the EUT cannot be configured to transmit continuously, then use a sweep trigger with the level set to enable triggering only on full power bursts and configure the EUT to transmit at full power for the entire duration of each sweep. Verify that the sweep time is less than or equal to the transmission burst duration.
Time gating can also be used under similar constraints
8. Trace average at least 100 traces in power averaging (rms) mode if sweep is set to auto-couple. To accurately determine the average power over the on and off time of the transmitter, it can be necessary to increase the number of traces to be averaged above 100, or if using a manually configured sweep time, increase the sweep time.
9. Use the peak marker function to determine the maximum amplitude level.

5.6.4. Test Setup

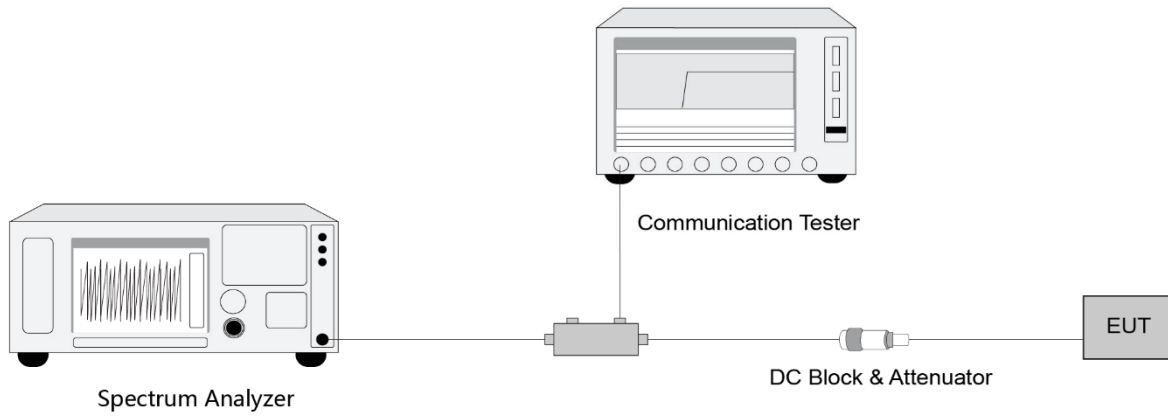

5.6.5. Test Result

Refer to Appendix A.5.

5.7. Radiated Spurious Emissions Measurement

5.7.1. Test Limit

Out of band emissions: The power of any emission outside of the authorized operating frequency ranges must be lower than the transmitter power (P) by a factor of at least $70 + 10 \log (P)$ dB.

E (dB μ V/m) = EIRP (dBm) - $20 \log D$ + 104.8; where D is the measurement distance in meters. The emission limit equal to 55.3dB μ V/m.

5.7.2. Test Procedure

ANSI C63.26-2015 - Section 5.2.7 & 5.5

5.7.3. Test Setting

1. RBW = 120kHz or 1MHz
2. VBW $\geq 3 \times$ RBW
3. Sweep time $\geq 10 \times$ (number of points in sweep) \times (transmission symbol period)
4. Detector = CISPR quasi-peak / average detector (Below 1 GHz, compliance with the limits shall be demonstrated using a CISPR quasi-peak detector and the related measurement bandwidth. Above 1 GHz, compliance with the limits shall be demonstrated using a linear average detector with a minimum resolution bandwidth of 1 MHz.)
5. The trace was allowed to stabilize

5.7.4. Test Setup

Below 1GHz Test Setup:

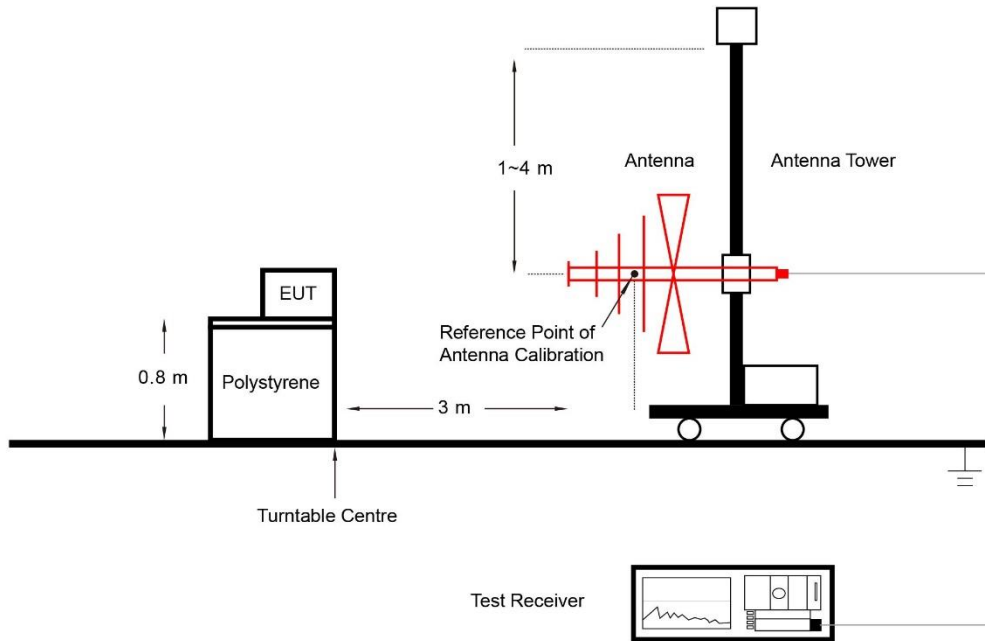

Above 1GHz Test Setup:

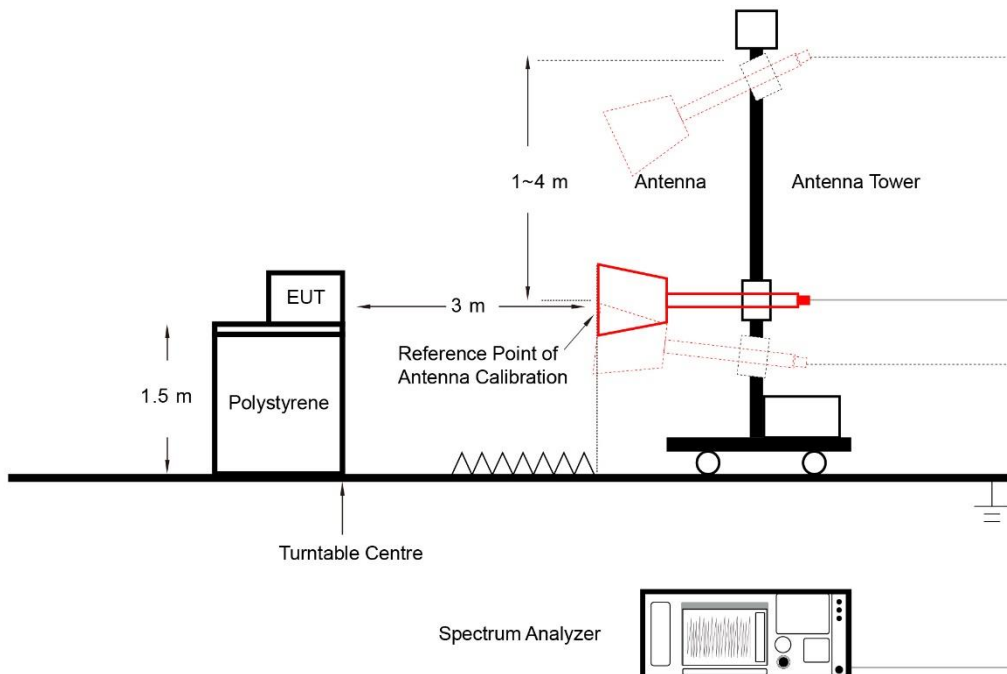

5.7.5. Test Result

Refer to Appendix A.6.

Appendix A - Test Result

A.1 Occupied Bandwidth Test Result

Test Site	SIP-SR1	Test Engineer	Yoniter Yang
Test Date	2024-05-05	Test Band	Band 30

Bandwidth (MHz)	Frequency (MHz)	99% Bandwidth (MHz)
QPSK		
5	2307.5	4.46
	2310.0	4.46
	2312.5	4.48
10	2310.0	8.93
16QAM		
5	2307.5	4.46
	2310.0	4.47
	2312.5	4.47
10	2310.0	8.93
64QAM		
5	2307.5	4.46
	2310.0	4.46
	2312.5	4.46
10	2310.0	8.92

99% Bandwidth – 5MHz Bandwidth QPSK

Low Channel Bandwidth

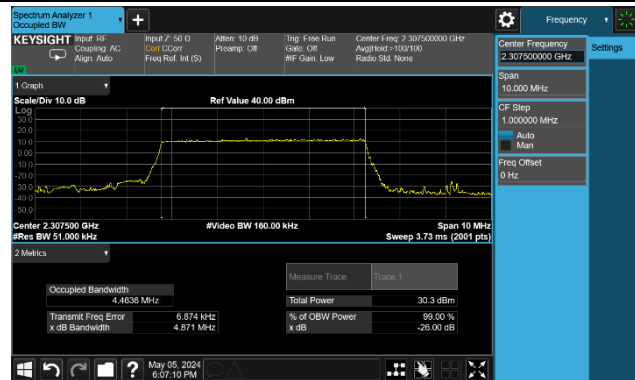

Middle Channel Bandwidth

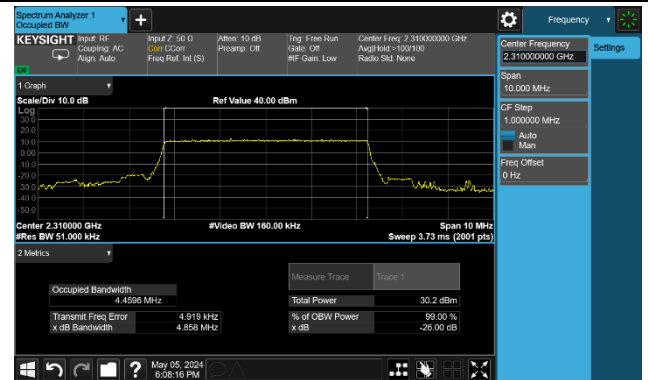

High Channel Bandwidth



99% Bandwidth – 10MHz Bandwidth QPSK

Middle Channel Bandwidth

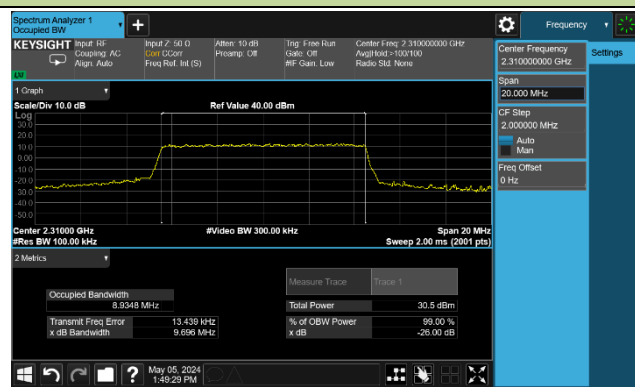

99% Bandwidth – 5MHz Bandwidth 16QAM

Low Channel Bandwidth

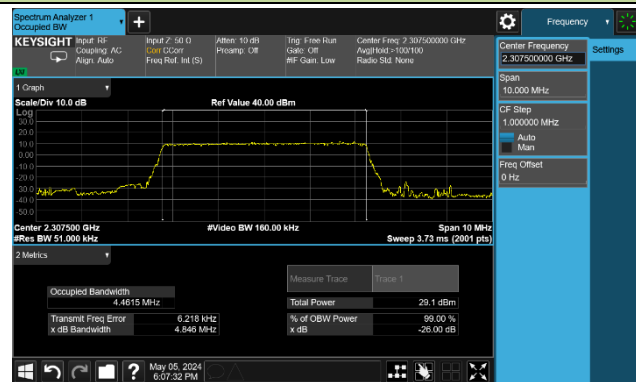

Middle Channel Bandwidth

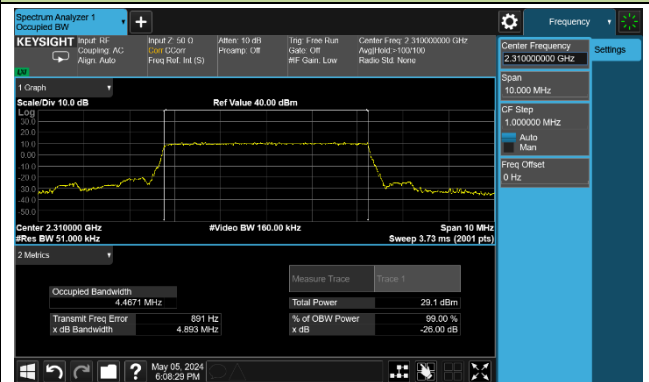

High Channel Bandwidth

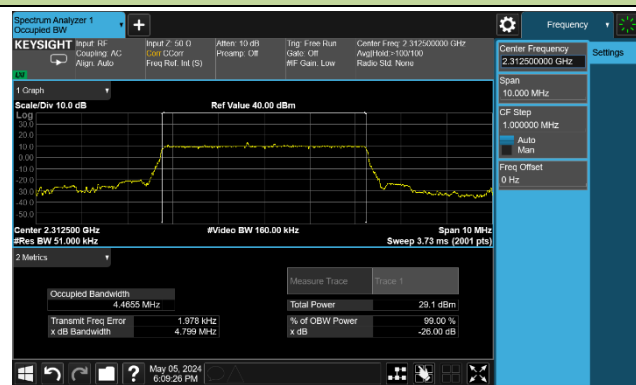

99% Bandwidth – 10MHz Bandwidth 16QAM

Low Channel Bandwidth

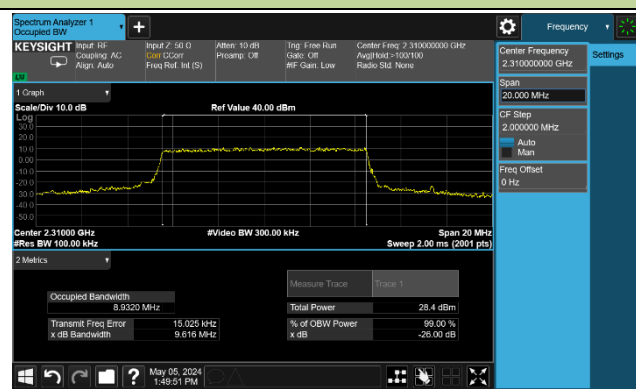

99% Bandwidth – 5MHz Bandwidth 64QAM

Low Channel Bandwidth

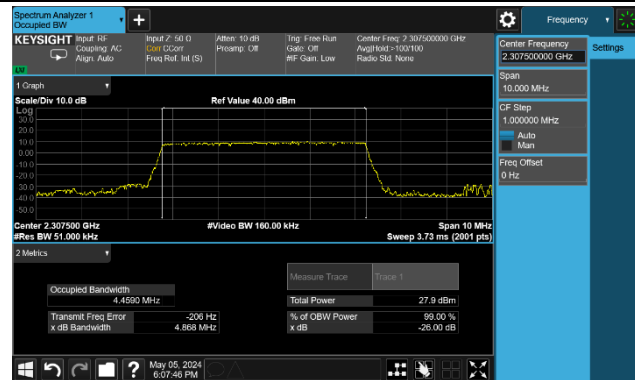

Middle Channel Bandwidth

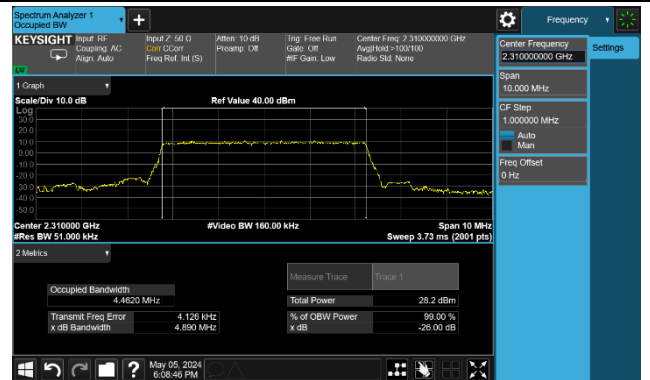

High Channel Bandwidth

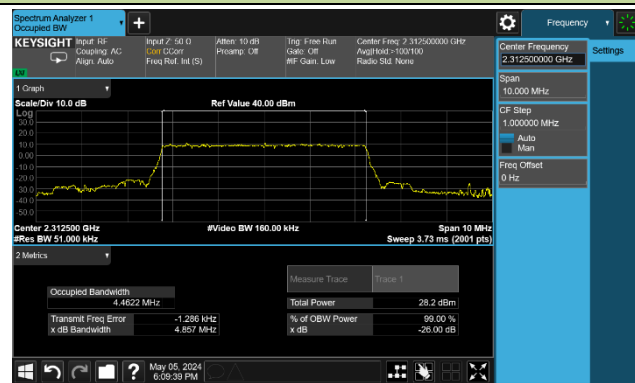

99% Bandwidth – 10MHz Bandwidth 64QAM

Low Channel Bandwidth

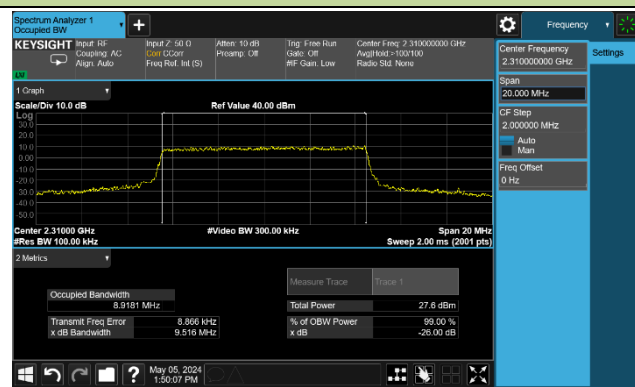

A.2 Frequency Stability Test Result

Test Site	WZ-TR3	Test Engineer	Jone Zhang
Test Date	2024-05-23 ~ 2024-05-27	Test Band	Band 30

Voltage	Temp (°C)	Frequency Range (MHz)		Delta (Hz)	Frequency stability (ppm)	Within Authorized Frequency Block
		2305.0	2315.0			
		f _L	f _H			
Normal	+ 20 (Ref)	2305.1950	2314.8050	0.00	0.0000	Pass
	+ 50	2305.1950	2314.8050	10.00	0.0043	Pass
	+ 40	2305.1950	2314.8050	11.10	0.0048	Pass
	+ 30	2305.1950	2314.8050	-10.90	-0.0047	Pass
	+ 10	2305.1950	2314.8050	14.20	0.0061	Pass
	0	2305.1950	2314.8050	-10.20	-0.0044	Pass
	- 10	2305.1950	2314.8050	-8.80	-0.0038	Pass
	- 20	2305.1950	2314.8050	10.10	0.0044	Pass
	- 30	2305.1950	2314.8050	11.40	0.0049	Pass
15%	+ 20	2305.1950	2314.8050	9.60	0.0042	Pass
-15%	+ 20	2305.1950	2314.8050	13.20	0.0057	Pass

A.3 Transmitter Output Power Test Result

Test Site	SIP-SR1	Test Engineer	Yoniter Yang
Test Date	2024-05-09	Test Band	Band 30

Frequency (MHz)	Channel Bandwidth (MHz)	RB Size	RB Offset	Power Spectral Density (dBm/5MHz)	EIRP Spectral Density (dBm/5MHz)	Limit (dBm /5MHz)
QPSK						
2307.5	5	1	0	22.23	23.21	< 23.98
2310.0				22.23	23.21	< 23.98
2312.5				22.27	23.25	< 23.98
2307.5	5	1	12	22.28	23.26	< 23.98
2310.0				22.24	23.22	< 23.98
2312.5				22.23	23.21	< 23.98
2307.5	5	1	24	22.22	23.20	< 23.98
2310.0				22.18	23.16	< 23.98
2312.5				22.15	23.13	< 23.98
2307.5	5	25	0	21.30	22.28	< 23.98
2310.0				21.31	22.29	< 23.98
2312.5				21.39	22.37	< 23.98
2310.0	10	1	0	22.16	23.14	< 23.98
2310.0			24	22.24	23.22	< 23.98
2310.0			49	22.45	23.43	< 23.98
2310.0		50	0	19.09	20.07	< 23.98

Note: The EIRP Spectral Density (dBm/5MHz) = Power Spectral Density (dBm/5MHz) + Antenna Gain (dBi)

Frequency (MHz)	Channel Bandwidth (MHz)	RB Size	RB Offset	Power Spectral Density (dBm/5MHz)	EIRP Spectral Density (dBm/5MHz)	Limit (dBm /5MHz)
16QAM						
2307.5	5	1	0	21.26	22.24	< 23.98
2310.0				21.35	22.33	< 23.98
2312.5				21.38	22.36	< 23.98
2307.5	5	1	12	21.62	22.60	< 23.98
2310.0				21.40	22.38	< 23.98
2312.5				21.75	22.73	< 23.98
2307.5	5	1	24	21.30	22.28	< 23.98
2310.0				21.15	22.13	< 23.98
2312.5				21.56	22.54	< 23.98
2307.5	5	25	0	20.24	21.22	< 23.98
2310.0				20.37	21.35	< 23.98
2312.5				20.39	21.37	< 23.98
2310.0	10	1	0	21.56	22.54	< 23.98
2310.0			24	21.65	22.63	< 23.98
2310.0			49	21.52	22.50	< 23.98
2310.0		50	0	17.93	18.91	< 23.98
Note: The EIRP Spectral Density (dBm/5MHz) = Power Spectral Density (dBm/5MHz) + Antenna Gain (dBi)						

Frequency (MHz)	Channel Bandwidth (MHz)	RB Size	RB Offset	Power Spectral Density (dBm/5MHz)	EIRP Spectral Density (dBm/5MHz)	Limit (dBm /5MHz)
64QAM						
2307.5	5	1	0	19.63	20.61	< 23.98
2310.0				20.68	21.66	< 23.98
2312.5				20.50	21.48	< 23.98
2307.5	5	1	12	20.43	21.41	< 23.98
2310.0				20.86	21.84	< 23.98
2312.5				20.25	21.23	< 23.98
2307.5	5	1	24	20.34	21.32	< 23.98
2310.0				20.37	21.35	< 23.98
2312.5				20.37	21.35	< 23.98
2307.5	5	25	0	19.22	20.20	< 23.98
2310.0				19.39	20.37	< 23.98
2312.5				19.40	20.38	< 23.98
2310.0	10	1	0	19.85	20.83	< 23.98
2310.0			24	20.35	21.33	< 23.98
2310.0			49	20.47	21.45	< 23.98
2310.0		50	0	16.89	17.87	< 23.98
Note: The EIRP Spectral Density (dBm/5MHz) = Power Spectral Density (dBm/5MHz) + Antenna Gain (dBi)						

A.4 Transmitter unwanted emissions (band-edge) Test Result

Test Site	SIP-SR1	Test Engineer	Yoniter Yang
Test Date	2024-05-08	Test Band	Band 30

5MHz Channel Bandwidth - 1RB
Low Channel_1RB_Low

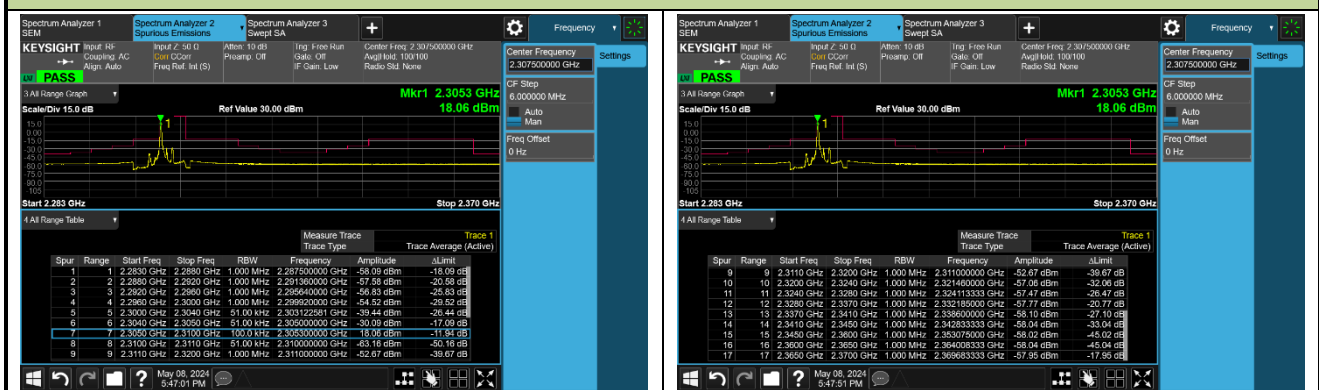

Extended Band Edge

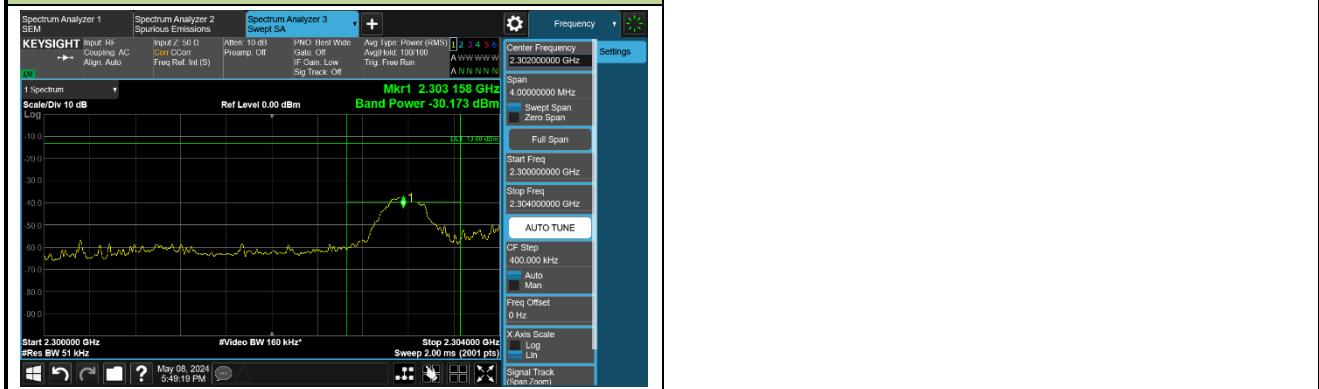

Low Channel_1RB_High

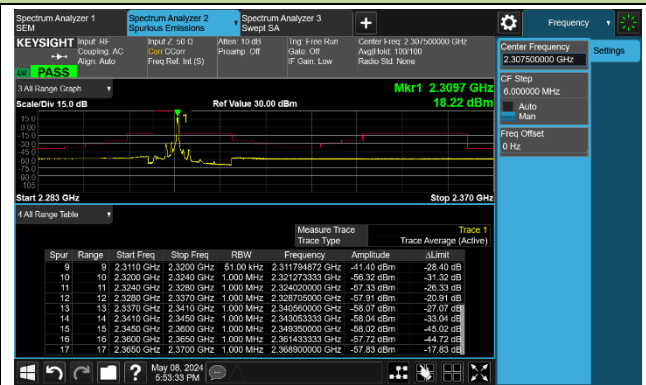
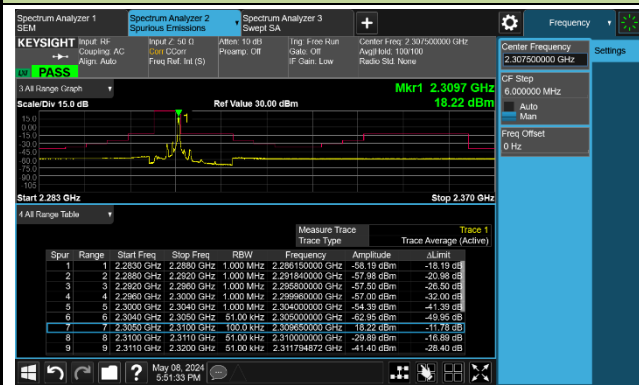

Extended Band Edge

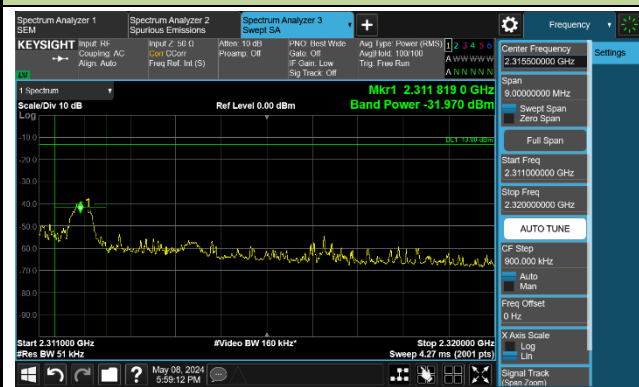

Middle Channel_1RB_Low

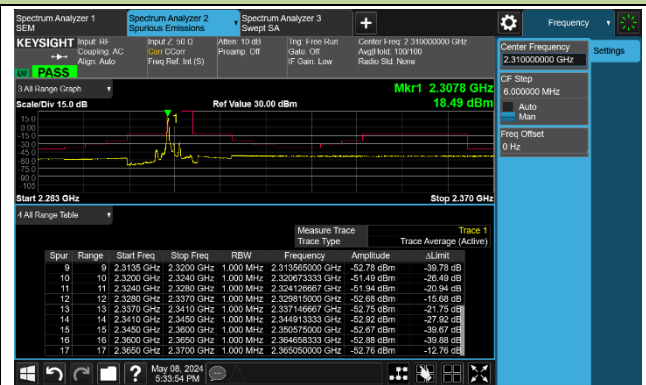
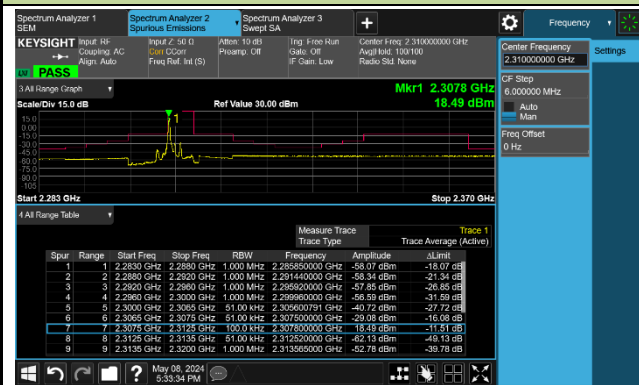

Extended Band Edge

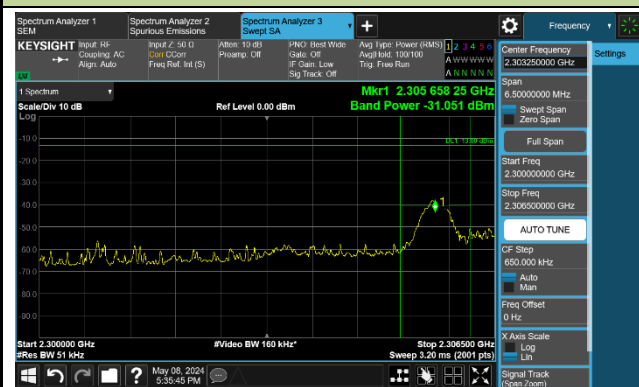

High Channel_1RB_High

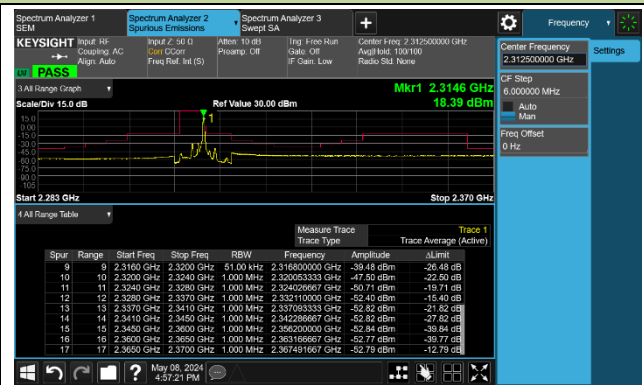
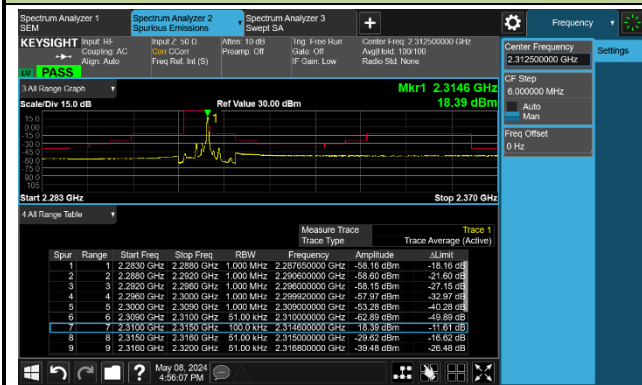

Extended Band Edge

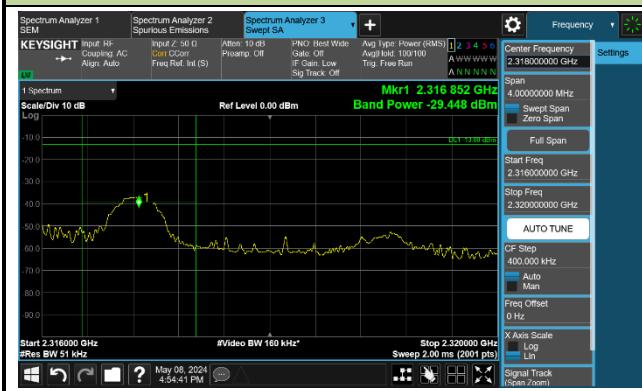

10MHz Channel Bandwidth - 1RB

Middle Channel_1RB_Low

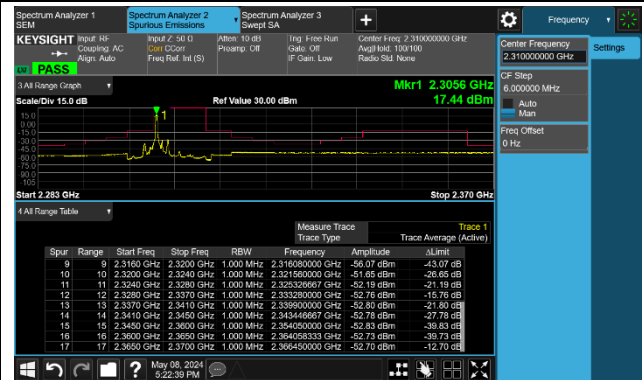
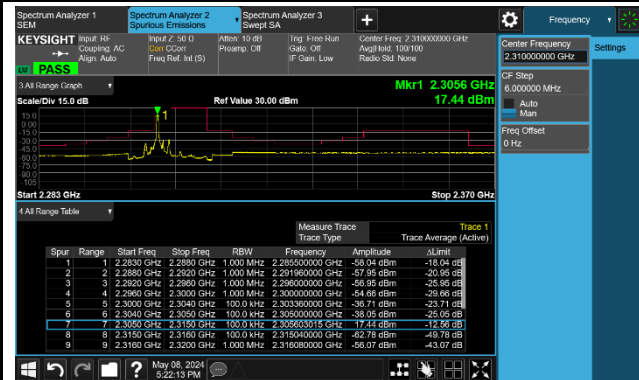

Extended Band Edge

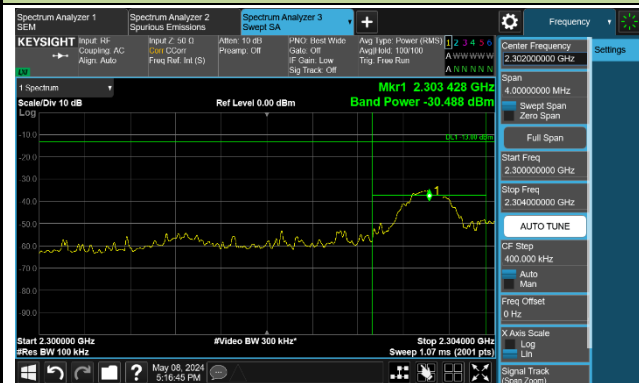

Middle Channel_1RB_High

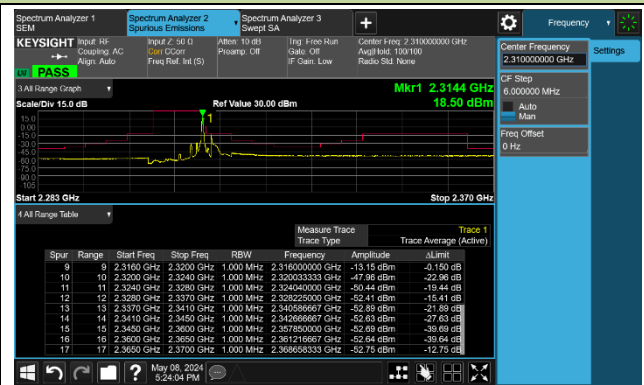
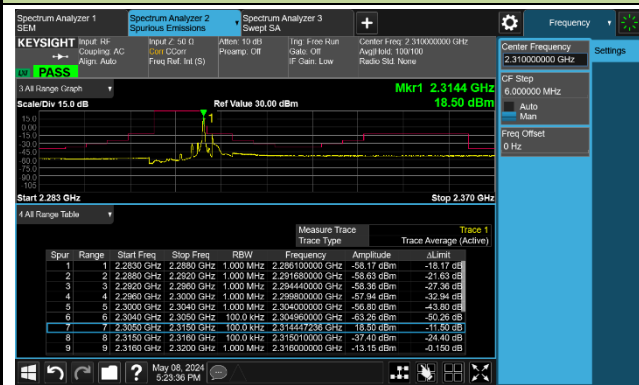

5MHz Channel Bandwidth - Full RB

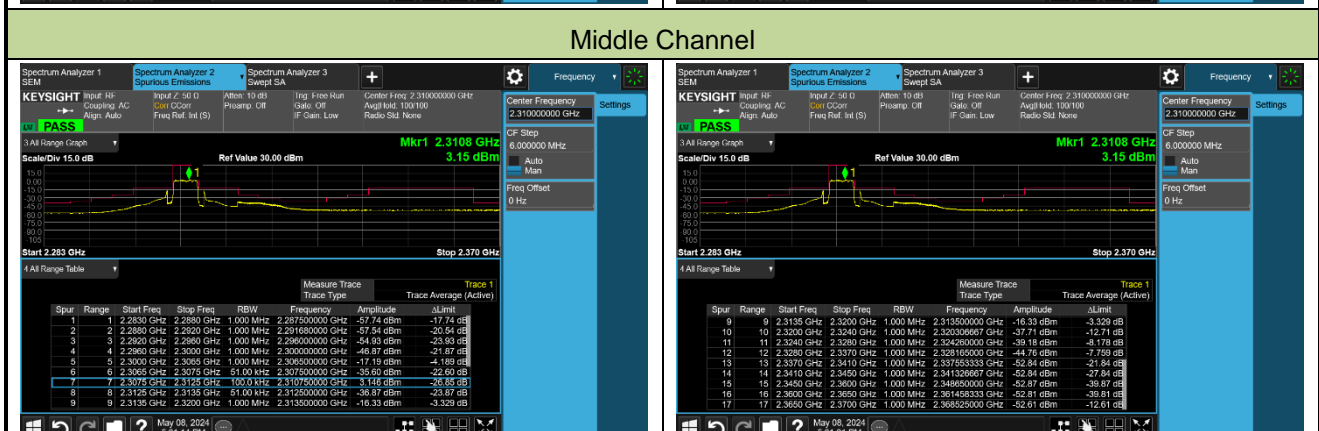
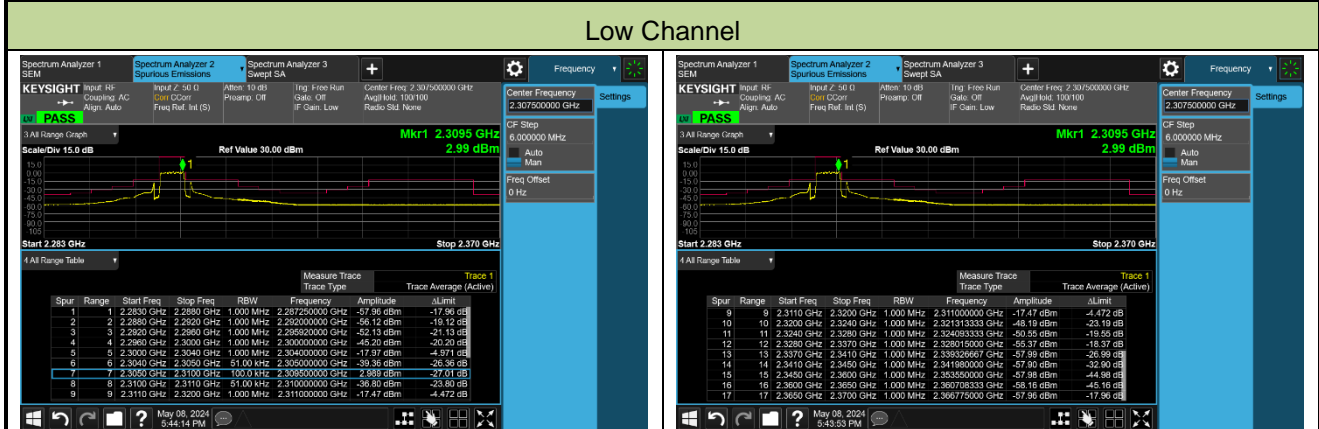

10MHz Channel Bandwidth - Full RB



A.5 Transmitter unwanted emissions (spurious) Test Result

Test Site	SIP-SR1	Test Engineer	Yoniter Yang
Test Date	2024-05-11 ~ 2024-05-13	Test Band	Band 30, 1RB, QPSK

Channel Bandwidth (MHz)	Frequency (MHz)	Frequency Range (MHz)	Max Spurious Emissions (dBm)	Limit (dBm)	Result
5	2307.5	30 ~ 1000	-44.81	≤ -40.00	Pass
		1000 ~ 24000	-41.74	≤ -40.00	Pass
	2310.0	30 ~ 1000	-45.70	≤ -40.00	Pass
		1000 ~ 24000	-41.75	≤ -40.00	Pass
	2312.5	30 ~ 1000	-45.23	≤ -40.00	Pass
		1000 ~ 24000	-41.73	≤ -40.00	Pass
10	2310.0	30 ~ 1000	-44.99	≤ -40.00	Pass
		1000 ~ 24000	-41.62	≤ -40.00	Pass

Note: The amplitude of Conducted Spurious emissions (frequency range from 9kHz to 30MHz) is that proximity to ambient noise, which also are attenuated more than 20 dB below the permissible value. Therefore, the data is not presented in the report.

5MHz Channel Bandwidth

Low Channel 30 ~ 1000MHz

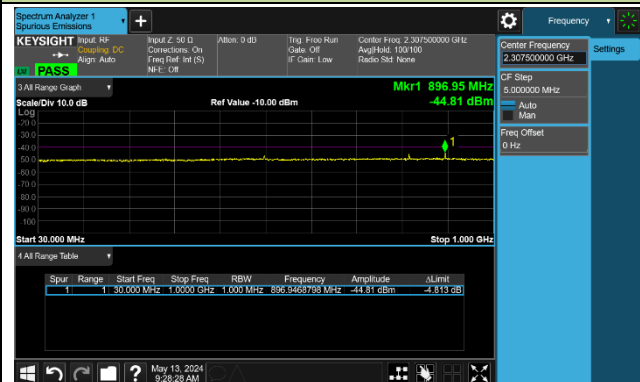

Low Channel 1000 ~ 24000MHz

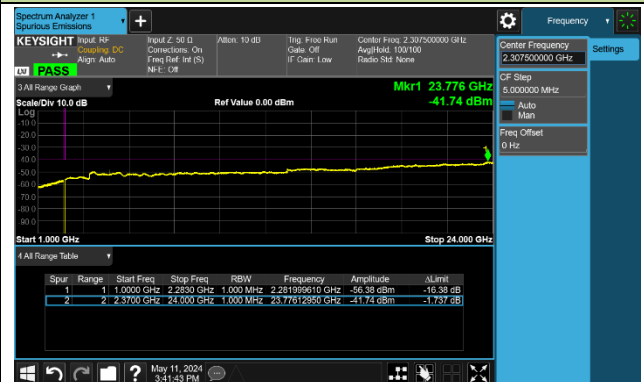

Middle Channel 30 ~ 1000MHz

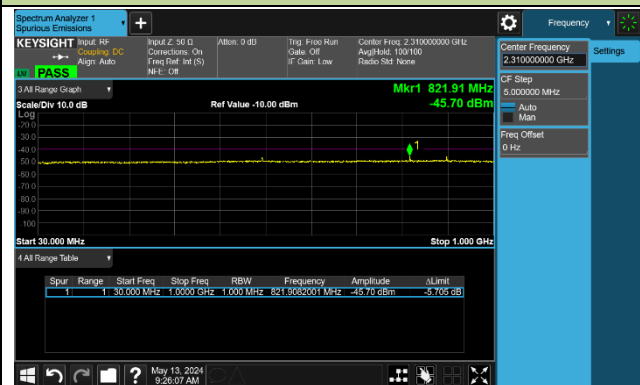

Middle Channel 1000 ~ 24000MHz

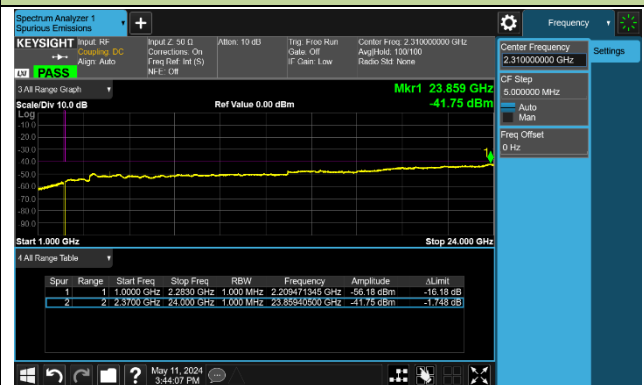

High Channel 30 ~ 1000MHz

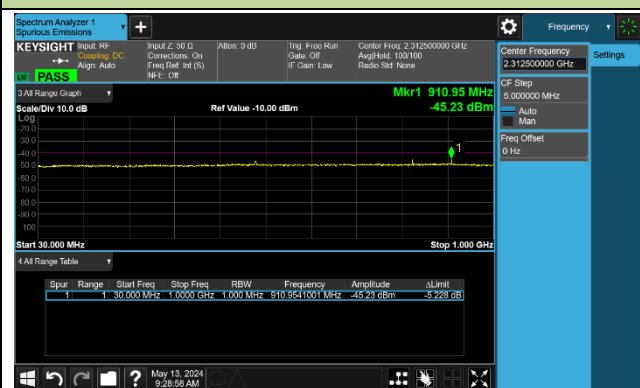

High Channel 1000 ~ 24000MHz

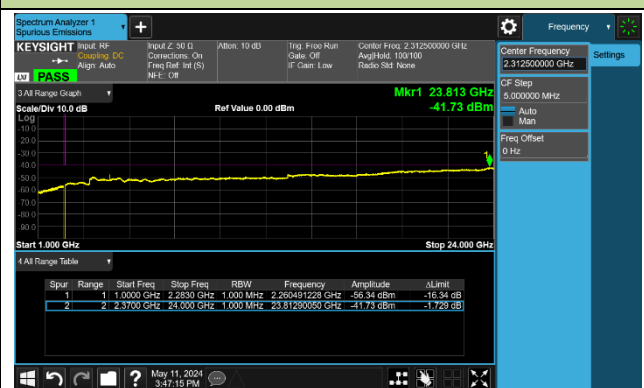

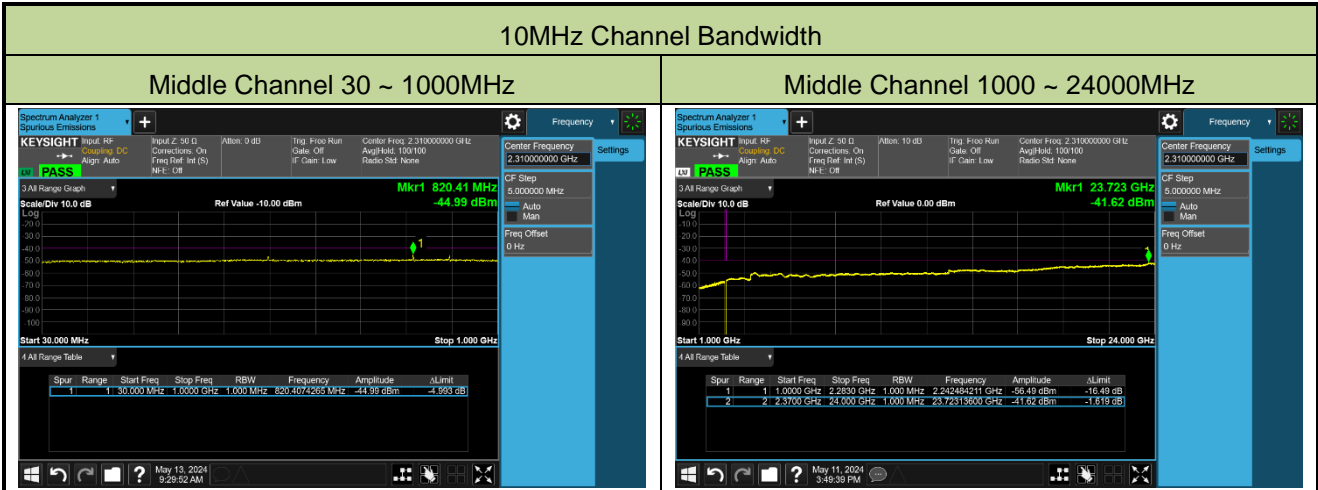

A.6 Radiated Spurious Emissions Test Result

Test Site	SIP-AC1	Test Engineer	Fusco Pan
Test Date	2024-05-06 ~ 2024-05-10	Test Band	Band 30, 1RB, QPSK

Frequency (MHz)	Reading Level (dB μ V)	Factor (dB/m)	Measure Level (dB μ V/m)	Limit (dB μ V/m)	Margin (dB)	Detector	Polarization
Low Channel							
465.0	3.9	22.3	26.2	55.3	-29.1	Quasi-Peak	Horizontal
891.8	-1.0	29.4	28.4	55.3	-26.9	Quasi-Peak	Horizontal
54.3	15.4	17.9	33.3	55.3	-22.0	Quasi-Peak	Vertical
462.6	3.4	22.4	25.8	55.3	-29.5	Quasi-Peak	Vertical
4451.0	38.7	3.7	42.4	55.3	-12.9	Peak	Horizontal
10936.5	35.7	13.1	48.8	55.3	-6.5	Peak	Horizontal
3813.5	39.8	2.6	42.4	55.3	-12.9	Peak	Vertical
9729.5	36.9	10.5	47.4	55.3	-7.9	Peak	Vertical
Middle Channel							
37.8	18.2	17.1	35.3	55.3	-20.0	Quasi-Peak	Horizontal
464.1	4.1	22.3	26.4	55.3	-28.9	Quasi-Peak	Horizontal
44.6	16.4	18.0	34.4	55.3	-20.9	Quasi-Peak	Vertical
463.6	4.3	22.4	26.7	55.3	-28.6	Quasi-Peak	Vertical
4111.0	39.4	3.3	42.7	55.3	-12.6	Peak	Horizontal
8845.5	36.9	9.9	46.8	55.3	-8.5	Peak	Horizontal
5335.0	36.8	5.9	42.7	55.3	-12.6	Peak	Vertical
11523.0	34.7	13.6	48.3	55.3	-7.0	Peak	Vertical
High Channel							
232.7	16.2	15.4	31.6	55.3	-23.7	Quasi-Peak	Horizontal
469.4	4.4	22.3	26.7	55.3	-28.6	Quasi-Peak	Horizontal
42.1	8.6	17.8	26.4	55.3	-28.9	Quasi-Peak	Vertical
935.5	-1.6	29.7	28.1	55.3	-27.2	Quasi-Peak	Vertical
4706.0	38.2	4.3	42.5	55.3	-12.8	Peak	Horizontal
8786.0	36.9	9.9	46.8	55.3	-8.5	Peak	Horizontal
6491.0	35.4	7.4	42.8	55.3	-12.5	Peak	Vertical
10715.5	34.8	12.9	47.7	55.3	-7.6	Peak	Vertical

Note1: Measure Level (dB μ V/m) = Reading Level (dB μ V) + Factor (dB/m)

Factor (dB/m) = Cable Loss (dB) + Antenna Factor (dB/m).

Note2: The peak-detection value will always be equal to or greater than average-detection value. In a result, the peak-detection value measured by spectrum analyzer shall represent the worst-case results.

Note 3: The amplitude of Radiated transmitter spurious emissions (Frequency range from 9kHz to 30MHz and above 18GHz) is that proximity to ambient noise, which also are attenuated more than 20 dB below the permissible value. Therefore, the data is not presented in the report.

Appendix B - Test Setup Photograph

Refer to "2404RSU035-UT" file.

Appendix C - EUT Photograph

Refer to "2404RSU035-UE" file.