

天线说明

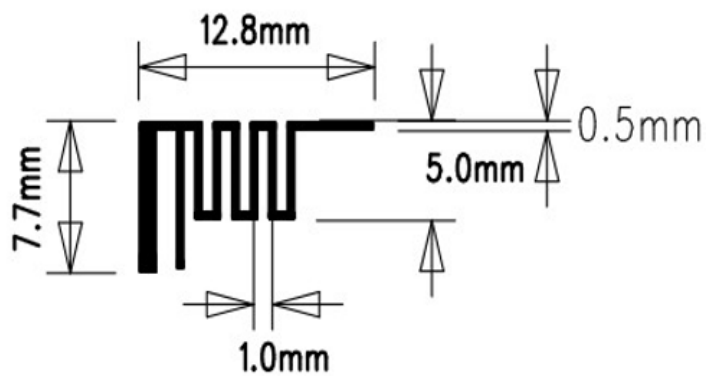

频点: 2402-2480

Gain: 1.25dbi

Antenna Material: PCB 板载天线

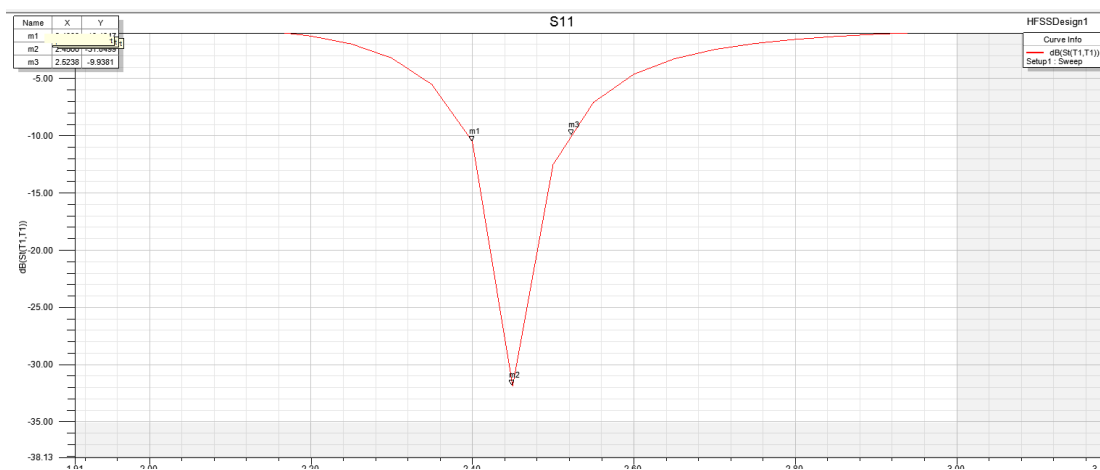

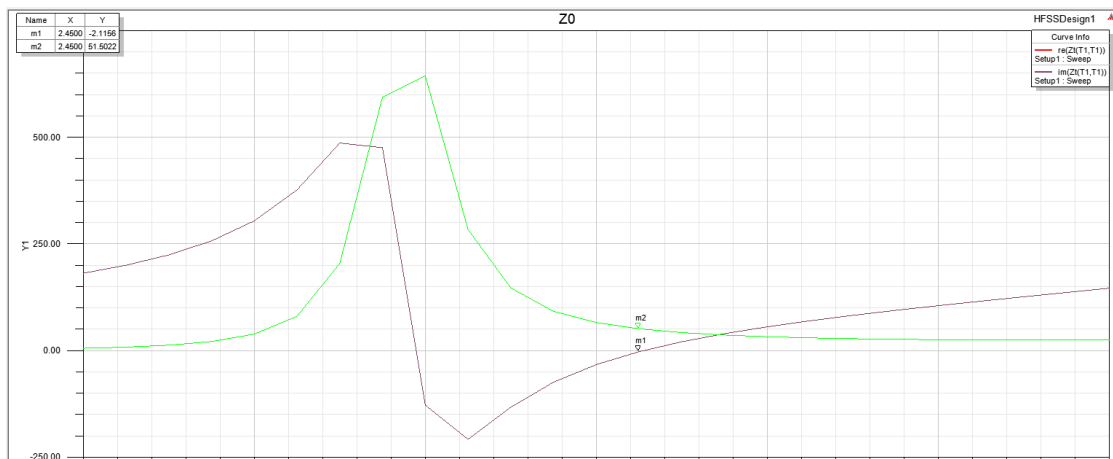
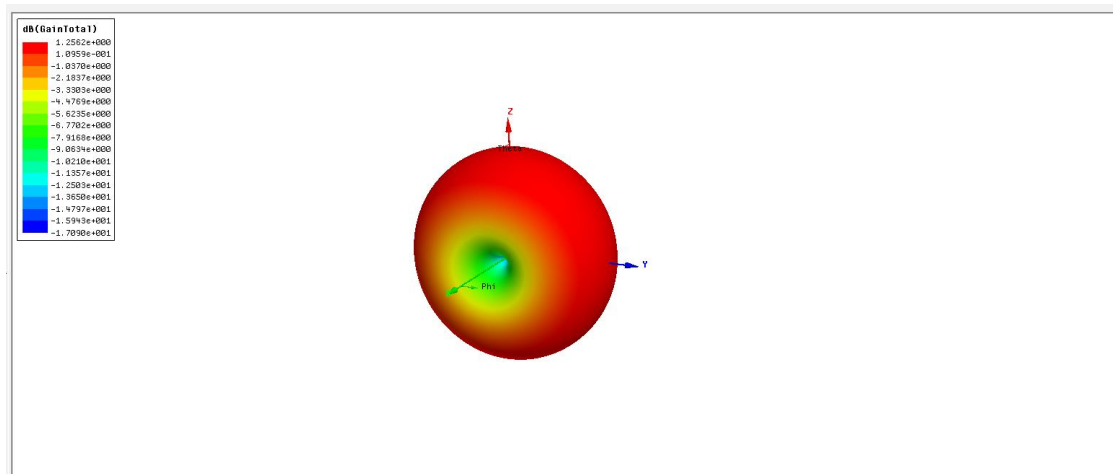
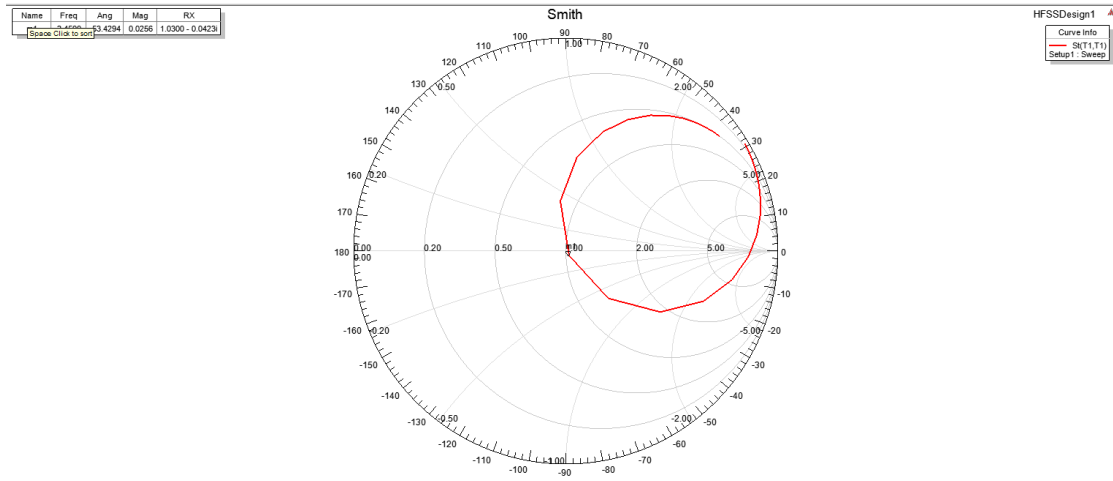

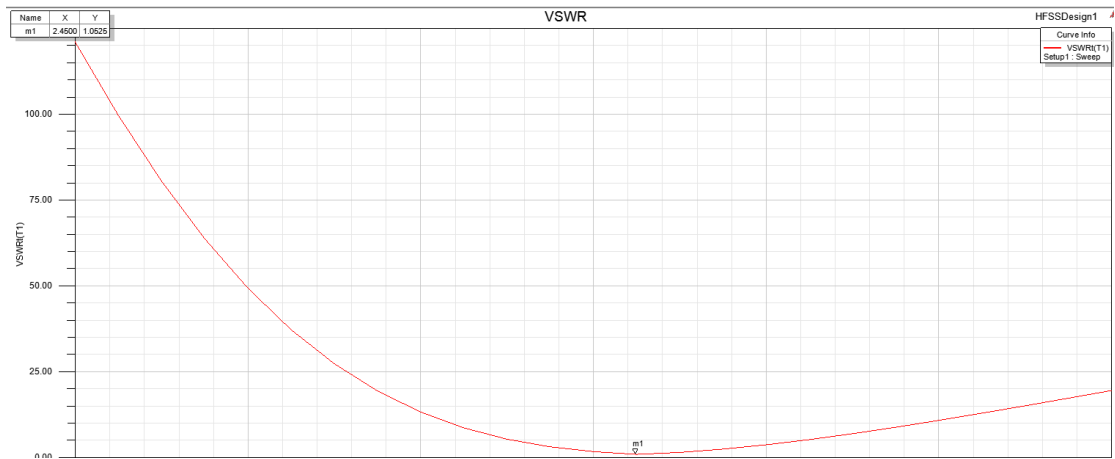

E-Plan

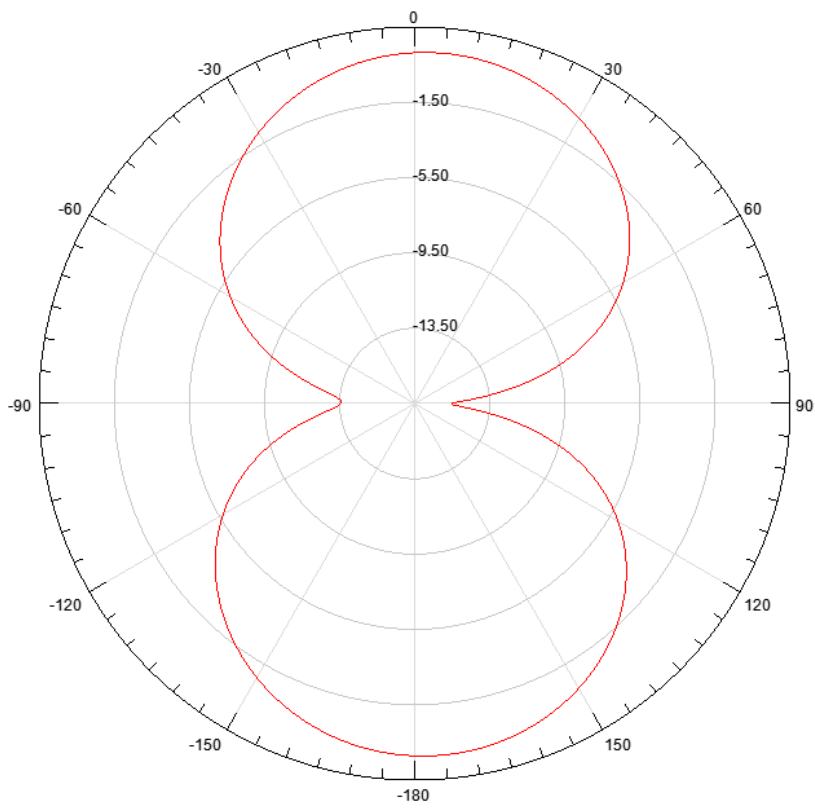

H-Plan

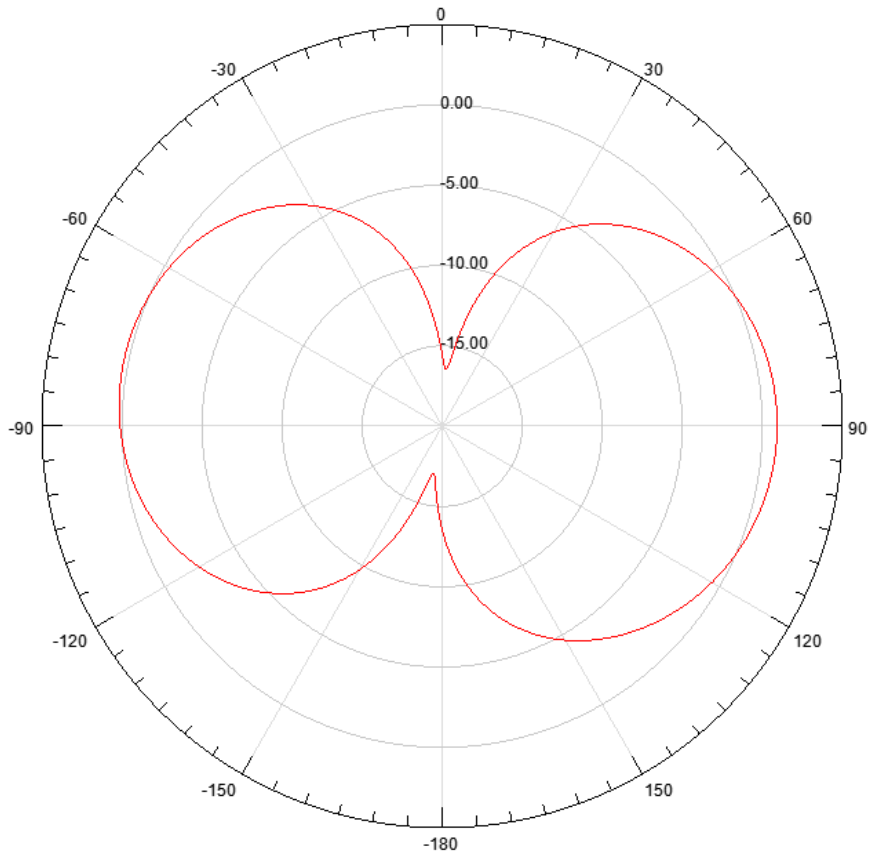

Manufacturer: [Tianchang Chuangxuan Network Technology Co., Ltd](#)
Address: [Zhenglong Road, Qinlan Town, Tianchang City, Anhui Province](#)