



Test Report No:
2410764R-RFUSV01S-B

TEST REPORT FCC Rules&Regulations

Product Name	Collector
Brand Name	Farmfit LLC
Model No.	FF-COLAC-1.0-915
FCC ID	2BEWM-FFCOLAC1915
Contains FCC ID	MCQ-XBEE3
Applicant's Name / Address	Farmfit LLC 22575 State Hwy 6 South, Navasota, Texas 77868, United States
Manufacturer's Name	Farmfit LLC
Test Method Requested, Standard	FCC CFR Title 47 Part 15 Subpart C Section 15.247 ANSI C63.10-2013
Verdict Summary	IN COMPLIANCE
Documented by Jinn Chen	<i>Jinn Chen</i>
Tested by Ivan Chuang	<i>Ivan Chuang</i>
Approved by Alan Chen	<i>Alan Chen</i>
Date of Receipt	2024/01/25
Date of Issue	2024/03/27
Report Version	V1.0

INDEX

	page
Competences and Guarantees.....	4
General Conditions.....	4
Revision History.....	5
Summary of Test Result.....	6
1. General Information.....	7
1.1. EUT Description.....	7
1.2. EUT Information.....	8
1.3. Testing Location Information.....	9
1.4. Measurement Uncertainty.....	10
1.5. List of Test Equipment.....	11
2. Test Configuration of EUT.....	12
2.1. Test Condition.....	12
2.2. Test Frequency Mode.....	12
2.3. Duty Cycle.....	13
2.4. The Worst Case Measurement Configuration.....	14
2.5. Tested System Details.....	15
2.6. Configuration of Tested System.....	15
3. AC Power Line Conducted Emission.....	16
3.1. Test Setup.....	16
3.2. Test Limit.....	16
3.3. Test Procedure.....	16
3.4. Test Result of AC Power Line Conducted Emission.....	16
4. 20dB Bandwidth.....	17
4.1. Test Setup.....	17
4.2. Test Limit.....	17
4.3. Test Procedures.....	17
4.4. Test Result of 20dB Bandwidth.....	17
5. Carrier Frequency Separation.....	18
5.1. Test Setup.....	18
5.2. Test Limit.....	18
5.3. Test Procedures.....	18
5.4. Test Result of Carrier Frequency Separation.....	18
6. Maximum Conducted Output Power.....	19
6.1. Test Setup.....	19
6.2. Test Limit.....	19
6.3. Test Procedures.....	19

6.4.	Test Result of Maximum Conducted Output Power	19
7.	Number of Hopping Frequency	20
7.1.	Test Setup	20
7.2.	Test Limit	20
7.3.	Test Procedure	20
7.4.	Test Result of Number of Hopping Frequency	20
8.	Dwell Time	21
8.1.	Test Setup	21
8.2.	Test Limit	21
8.3.	Test Procedure	21
8.4.	Test Result of Dwell Time.....	21
9.	Antenna Port Conducted Emission	22
9.1.	Test Setup	22
9.2.	Test Limit	22
9.3.	Test Procedure	22
9.4.	Test Result of Antenna Port Conducted Emission	22
10.	Radiated Emission.....	23
10.1.	Test Setup	23
10.2.	Test Limit	24
10.3.	Test Procedure	24
10.4.	Test Result of Radiated Emission	24
Appendix A. Test Result of AC Power Line Conducted Emission		
Appendix B. Test Result of 20dB Bandwidth		
Appendix C. Test Result of Carrier Frequency Separation		
Appendix D. Test Result of Maximum Conducted Output Power		
Appendix E. Test Result of Number of Hopping Frequency		
Appendix F. Test Result of Dwell Time		
Appendix G. Test Result of Antenna Port Conducted Emission		
Appendix H. Test Result of Radiated Emission		
Appendix I. Test Setup Photograph		

Competences and Guarantees

DEKRA is a testing laboratory competent to carry out the tests described in this report.

In order to assure the traceability to other national and international laboratories, DEKRA has a calibration and maintenance program for its measurement equipment.

DEKRA guarantees the reliability of the data presented in this report, which is the result of the measurements and the tests performed to the item under test on the date and under the conditions stated in the report and it is based on the knowledge and technical facilities available at DEKRA at the time of performance of the test.

DEKRA is liable to the client for the maintenance of the confidentiality of all information related to the item under test and the results of the test.

The results presented in this Test Report apply only to the particular item under test established in this document.

IMPORTANT: No parts of this report may be reproduced or quoted out of context, in any form or by any means, except in full, without the previous written permission of DEKRA.

General Conditions

1. The test results relate only to the samples tested.
2. The test results shown in the test report are traceable to the national/international standard through the calibration report of the equipment and evaluated measurement uncertainty herein.
3. This report must not be used to claim product endorsement by TAF or any agency of the government.
4. The test report shall not be reproduced without the written approval of DEKRA Testing and Certification Co., Ltd.
5. Measurement uncertainties evaluated for each testing system and associated connections are given here to provide the system information for reference. Compliance determinations do not take into account measurement uncertainties for each testing system, but are based on the results of the compliance measurement.

Revision History

Version	Description	Issued Date
V1.0	Initial issue of report	2024/03/27

Summary of Test Result

Report Clause	Test Items	Result (PASS/FAIL)	Remark
3	AC Power Line Conducted Emission	PASS	-
4	20dB Bandwidth	PASS	-
5	Carrier Frequency Separation	PASS	-
6	Maximum Conducted Output Power	PASS	-
7	Number of Hopping Frequency	PASS	-
8	Dwell Time	PASS	-
9	Antenna Port Conducted Emission	PASS	-
10	Radiated Emission	PASS	-

Comments and Explanations

The declared of product specification for EUT presented in the report are provided by the manufacturer, and the manufacturer takes all the responsibilities for the accuracy of product specification.

1. General Information

1.1. EUT Description

Frequency Range	902 ~ 928 MHz
Operating Frequency	915 ~ 919.86 MHz
Channel Number	50 Channels
Type of Modulation	FHSS

Accessories Information		
No.	Equipment Name	Description
1	power cable	Non-Shielded, 3.5m

Antenna Information				
Item.	Brand Name	Part No.	Type	Gain (dBi)
1	L-COM	HG908P	Patch	8

Note:

1. The above EUT information is declared by the manufacturer.
2. The antenna of EUT conforms to FCC 15.203.

Working Frequency of Each Channel					
Channel	Frequency (MHz)	Channel	Frequency (MHz)	Channel	Frequency (MHz)
00	915.00	01	915.10	02	915.20
03	915.30	04	915.40	05	915.50
06	915.60	07	915.69	08	915.79
09	915.89	10	915.99	11	916.09
12	916.19	13	916.29	14	916.39
15	916.49	16	916.59	17	916.69
18	916.79	19	916.88	20	916.98
21	917.08	22	917.18	23	917.28
24	917.38	25	917.48	26	917.58
27	917.68	28	917.78	29	917.88
30	917.98	31	918.07	32	918.17
33	918.27	34	918.37	35	918.47
36	918.57	37	918.67	38	918.77
39	918.87	40	918.97	41	919.07
42	919.17	43	919.26	44	919.36
45	919.46	46	919.56	47	919.66
48	919.76	49	919.86	--	--

1.2. EUT Information

EUT Power Type	From AC power
----------------	---------------

1.3. Testing Location Information

USA	FCC Registration Number: TW0033
Canada	CAB Identifier Number: TW3023 / Company Number: 26930

Site Description	Accredited by TAF
	Accredited Number: 3023

Test Laboratory	DEKRA Testing and Certification Co., Ltd.
	Linkou Laboratory
Address	No. 5-22, Ruishukeng Linkou District, New Taipei City, 24451, Taiwan, R.O.C.
Performed Location	No. 26, Huaya 1st Rd., Guishan Dist., Taoyuan City 333411, Taiwan, R.O.C.
Phone Number	+886-3-275-7255
Fax Number	+886-3-327-8031

Ambient conditions in the laboratory:

Performed Item	Items	Required	Actual	Test Date
AC Power Line Conducted Emission	Temperature (°C)	10~40 °C	23.4 °C	2024/02/21
	Humidity (%RH)	10~90 %	55.2 %	
Radiated Emission	Temperature (°C)	10~40 °C	20.2 °C	2024/02/19
	Humidity (%RH)	10~90 %	65.8 %	
RF Conducted Emission	Temperature (°C)	10~40 °C	19.0 °C	2024/02/15~2024/02/16
	Humidity (%RH)	10~90 %	72.0 %	

1.4. Measurement Uncertainty

Uncertainties have been calculated according to the DEKRA internal document with the emissions test results be included in the report. The measurement uncertainties given below are based on a 95% confidence level (based on a coverage factor (k=2)).

Test item	Uncertainty
AC Power Line Conducted Emission	±3.50 dB
20dB Bandwidth	±1580.61 Hz
Carrier Frequency Separation	±1580.61 Hz
Maximum Conducted Output Power	Spectrum Analyzer: ±2.14 dB Power Meter: ±1.05 dB
Number of Hopping Frequency	N/A
Dwell Time	± 0.53 %
Antenna Port Conducted Emission	±2.14 dB
Radiated Emission	9 kHz~30 MHz: ±3.88 dB 30 MHz~1 GHz: ±4.42 dB 1 GHz~18 GHz: ±4.28 dB 18 GHz~40 GHz: ±3.90 dB

1.5. List of Test Equipment

For Conduction Measurements / HY-SR01

	Equipment	Manufacturer	Model No.	Serial No.	Cal. Date	Due Date
V	EMI Test Receiver	R&S	ESR7	101601	2023/06/20	2024/06/19
V	Two-Line V-Network	R&S	ENV216	101306	2023/03/16	2024/03/15
V	Two-Line V-Network	R&S	ENV216	101307	2023/08/17	2024/08/16
V	Coaxial Cable	SUHNER	RG400_BNC	RF001	2024/01/10	2025/01/09

Note:

1. All equipments are calibrated every one year.
2. The test instruments marked with "V" are used to measure the final test results.
3. Test Software Version: e3 230303 dekra V9.

For Conducted Measurements / HY-SR02

	Equipment	Manufacturer	Model No.	Serial No.	Cal. Date	Due Date
V	Spectrum Analyzer	R&S	FSV30	103465	2023/06/14	2024/06/13
V	Spectrum Analyzer	KEYSIGHT	N9010A	MY53470892	2023/11/09	2024/11/08
V	Peak Power Analyzer	KEYSIGHT	8990B	MY51000539	2023/05/15	2024/05/14
V	Wideband Power Sensor	KEYSIGHT	N1923A	MY59240002	2023/05/18	2024/05/17
V	Wideband Power Sensor	KEYSIGHT	N1923A	MY59240003	2023/05/18	2024/05/17

Note:

1. All equipments are calibrated every one year.
2. The test instruments marked with "V" are used to measure the final test results.
3. Test Software Version: RF Conducted Test Tools R3 V3.0.0.14.

For Radiated Measurements /HY-CB03

	Equipment	Manufacturer	Model No.	Serial No.	Cal. Date	Due Date
	Loop Antenna	AMETEK	HLA6121	56736	2023/05/23	2024/05/24
V	Bi-Log Antenna	SCHWARZBECK	VULB9168	9168-0675	2023/08/09	2025/08/08
V	Horn Antenna	RF SPIN	DRH18-E	210507A18ES	2023/05/11	2024/05/10
	Horn Antenna	Com-Power	AH-840	101100	2023/10/02	2025/10/01
V	Pre-Amplifier	SGH	SGH0301-9	20211007-11	2024/01/10	2025/01/09
V	Pre-Amplifier	SGH	SGH118-HS	20200701	2024/01/10	2025/01/09
V	Pre-Amplifier	EMCI	EMC05820SE	980310	2024/01/10	2025/01/09
	Pre-Amplifier	EMCI	EMC184045SE	980369	2024/01/10	2025/01/09
	Coaxial Cable	EMCI	EMC102-KM-KM-600	1160314	2024/01/10	2025/01/09
	Coaxial Cable	EMCI	EMC102-KM-KM-7000	170242	2024/01/10	2025/01/09
	Filter	MICRO TRONICS	BRM50702	G249	2024/01/05	2025/01/04
	Filter	MICRO TRONICS	BRM50716	G067	2024/01/05	2025/01/04
V	EMI Test Receiver	R&S	ESR3	102793	2023/12/11	2024/12/10
V	Spectrum Analyzer	R&S	FSV3044	101115	2024/01/11	2025/01/10
V	Coaxial Cable	SGH	HA800	GD20110223-2	2024/01/10	2025/01/09
V	Coaxial Cable	SGH	HA800	GD20110222-4	2024/01/10	2025/01/09
V	Coaxial Cable	SGH	SGH18	202108-5	2024/01/10	2025/01/09
V	Coaxial Cable	SGH	SGH18	202212-2	2023/11/27	2024/11/26

Note:

1. Bi-Log Antenna and Horn Antenna (AH-840) is calibrated every two years, the other equipments are calibrated every one year.
2. The test instruments marked with "V" are used to measure the final test results.
3. Test Software Version: e3 230303 dekra V9.

2. Test Configuration of EUT

2.1. Test Condition

EUT Operational Condition	
Testing Voltage	AC 120V/60Hz

2.2. Test Frequency Mode

Test Software Version	cmd V10.0.19045.4046
-----------------------	----------------------

Modulation	Frequency (MHz)	Power Setting
FHSS	915	11
	919.86	11

2.3. Duty Cycle

Modulation	On Times (ms)	On+Off Times (ms)	Duty Cycle (%)	Duty Cycle Correction Factor (dB)
FHSS	--	--	100	--

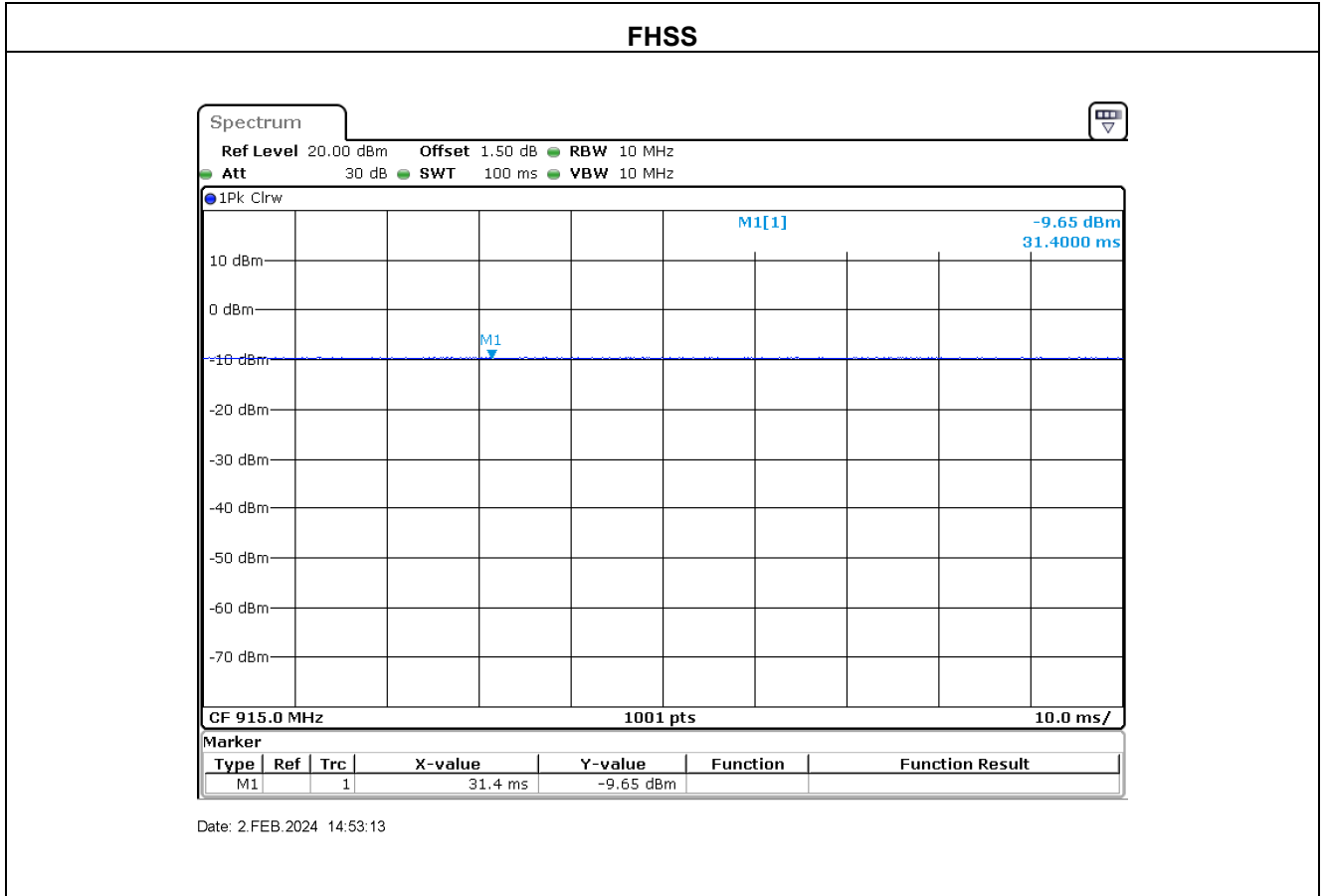

2.4. The Worst Case Measurement Configuration

Test Mode	Mode 1	Transmit
-----------	--------	----------

Note:

1. Determining compliance shall be based on the results of the compliance measurement, not taking into account measurement instrumentation uncertainty.
2. For radiated emission below 1 GHz and AC power line conducted emission have performed all modes of operation were investigated and the worst-case emissions are reported.

2.5. Tested System Details

No.	Equipment	Brand Name	Model No.	Serial No.	Power Cord
1	Notebook PC	DELL	Latitude 5501	9V4JL13	N/A

2.6. Configuration of Tested System

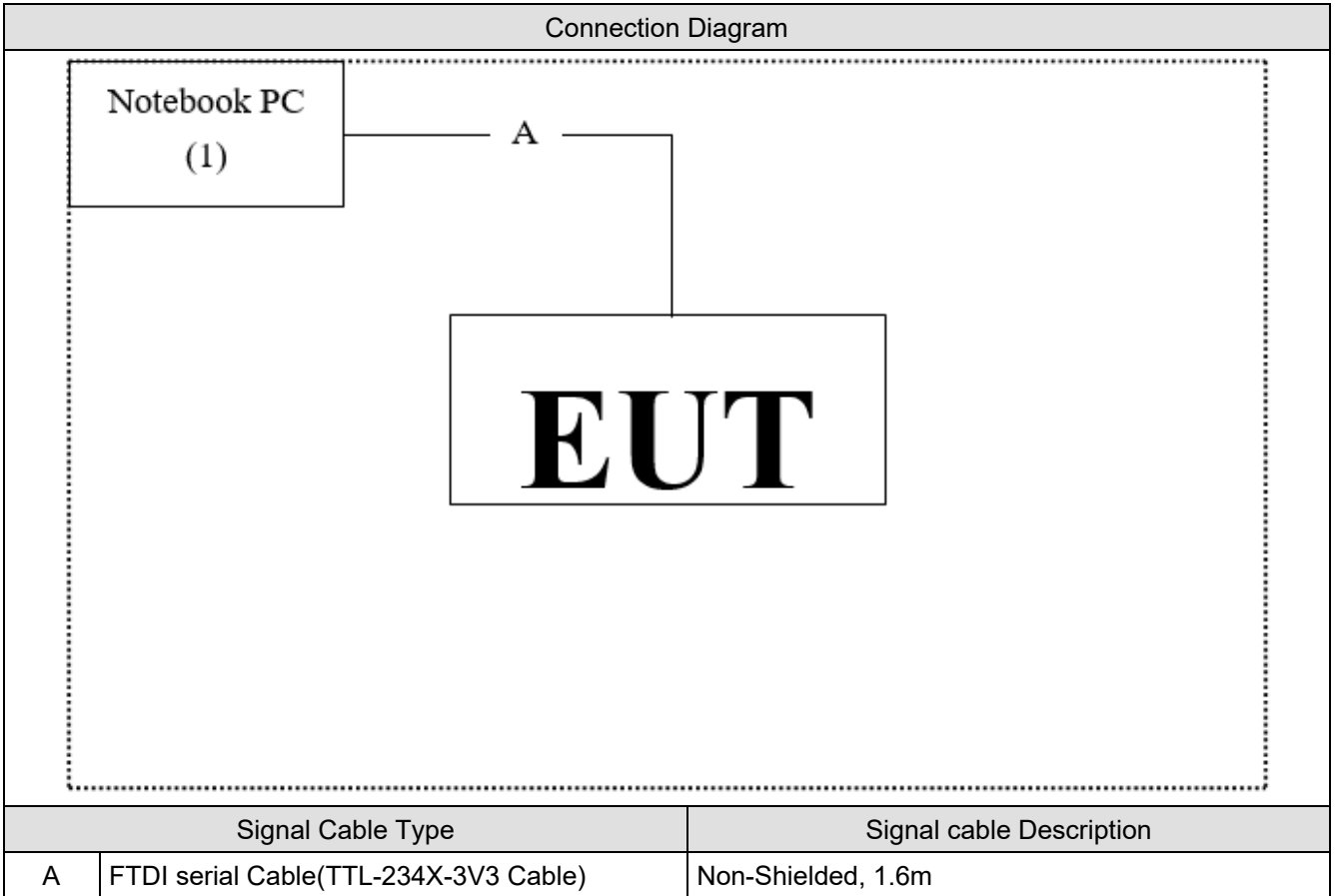

3. AC Power Line Conducted Emission

3.1. Test Setup

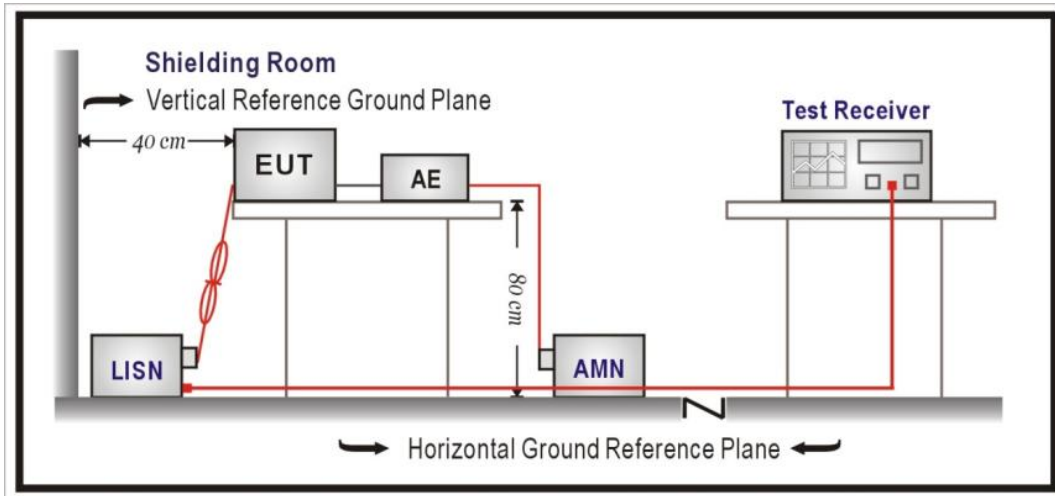

3.2. Test Limit

Frequency (MHz)	QP (dBuV)	AV (dBuV)
0.15 - 0.50	66 - 56	56 - 46
0.50 - 5.0	56	46
5.0 - 30	60	50

Remarks: In the above table, the tighter limit applies at the band edges.

3.3. Test Procedure

The EUT was setup according to ANSI C63.10: 2013 for AC Power Line Conducted Emissions.

3.4. Test Result of AC Power Line Conducted Emission

Refer as Appendix A

4. 20dB Bandwidth

4.1. Test Setup

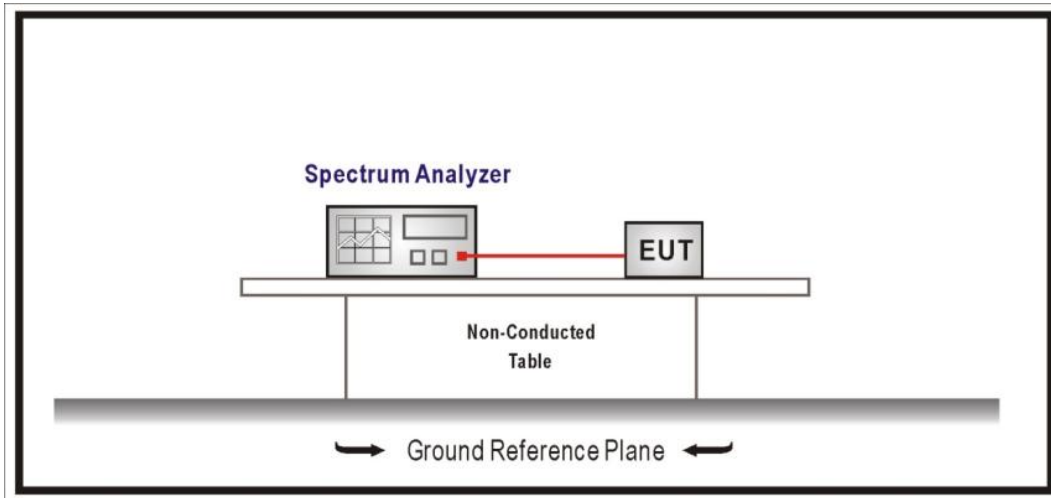

4.2. Test Limit

N/A

4.3. Test Procedures

The EUT was setup according to ANSI C63.10: 2013 and tested according to FHSS test procedure of KDB 558074.

4.4. Test Result of 20dB Bandwidth

Refer as Appendix B

5. Carrier Frequency Separation

5.1. Test Setup

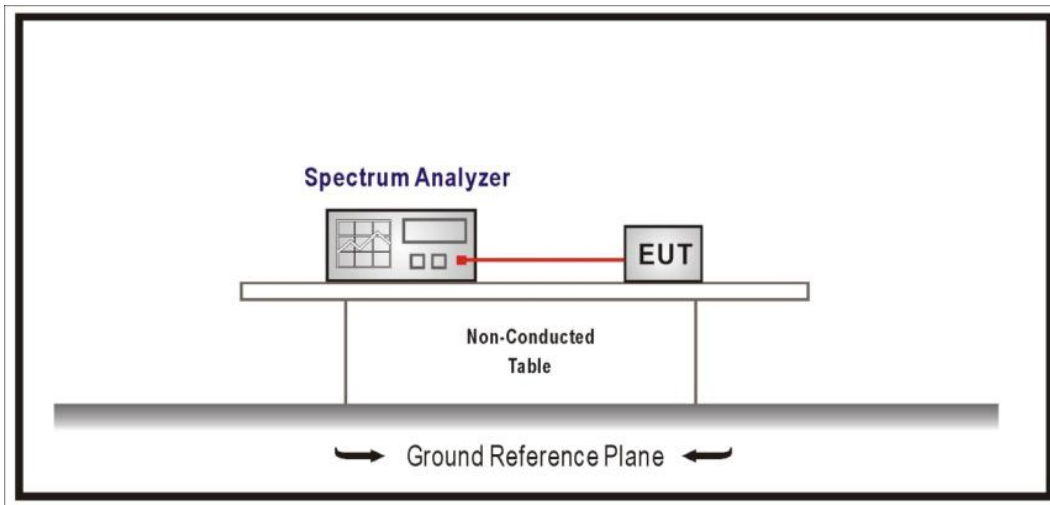

5.2. Test Limit

Frequency hopping systems shall have hopping channel carrier frequencies separated by a minimum of 25 kHz or the 20 dB bandwidth of the hopping channel, whichever is greater. Alternatively, frequency hopping systems operating in the 2400 ~ 2483.5 MHz band may have hopping channel carrier frequencies that are separated by 25 kHz or two-thirds of the 20 dB bandwidth of the hopping channel, whichever is greater, provided the systems operate with a Maximum Conducted Output Power no greater than 125 mW. The system shall hop to channel frequencies that are selected at the system hopping rate from a pseudo randomly ordered list of hopping frequencies. Each frequency must be used equally on the average by each transmitter. The system receivers shall have input bandwidths that match the hopping channel bandwidths of their corresponding transmitters and shall shift frequencies in synchronization with the transmitted signals.

5.3. Test Procedures

The EUT was setup according to ANSI C63.10: 2013 and tested according to FHSS test procedure of KDB 558074.

5.4. Test Result of Carrier Frequency Separation

Refer as Appendix C

6. Maximum Conducted Output Power

6.1. Test Setup

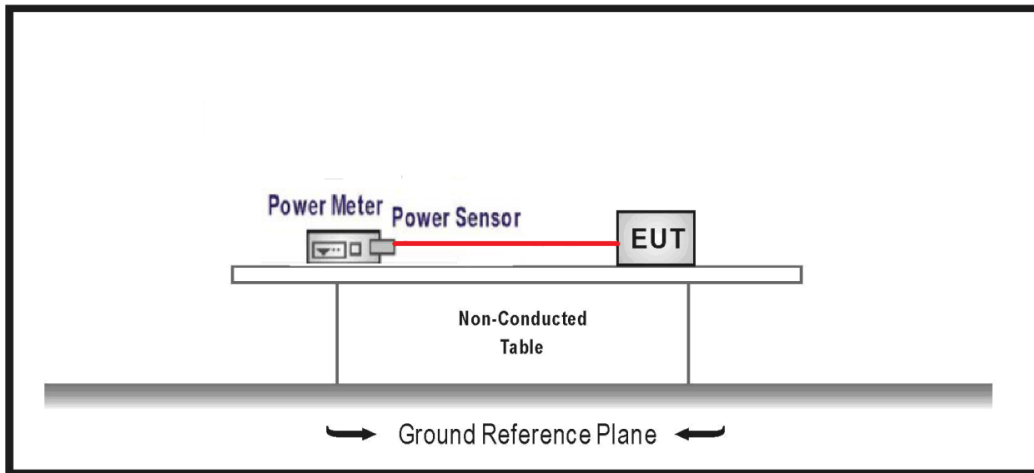

6.2. Test Limit

For frequency hopping systems operating in the 902 ~ 928 MHz band:

1. Number of Hopping Frequencies ≥ 50 : 1 watt (30dBm)
2. $50 >$ Number of Hopping Frequencies ≥ 25 : 0.25 watt (23.98dBm)

For frequency hopping systems operating in the 2400 ~ 2483.5 MHz band:

1. Number of Hopping Frequencies ≥ 75 : 1 watt (30dBm)
2. $75 >$ Number of Hopping Frequencies ≥ 15 : 0.125 watts (20.97dBm)

For frequency hopping systems operating in the 5725 ~ 5850 MHz band:

Number of Hopping Frequencies ≥ 75 : 1 watt (30dBm)

6.3. Test Procedures

The EUT was setup according to ANSI C63.10: 2013 and tested according to FHSS test procedure of KDB 558074.

6.4. Test Result of Maximum Conducted Output Power

Refer as Appendix D

7. Number of Hopping Frequency

7.1. Test Setup

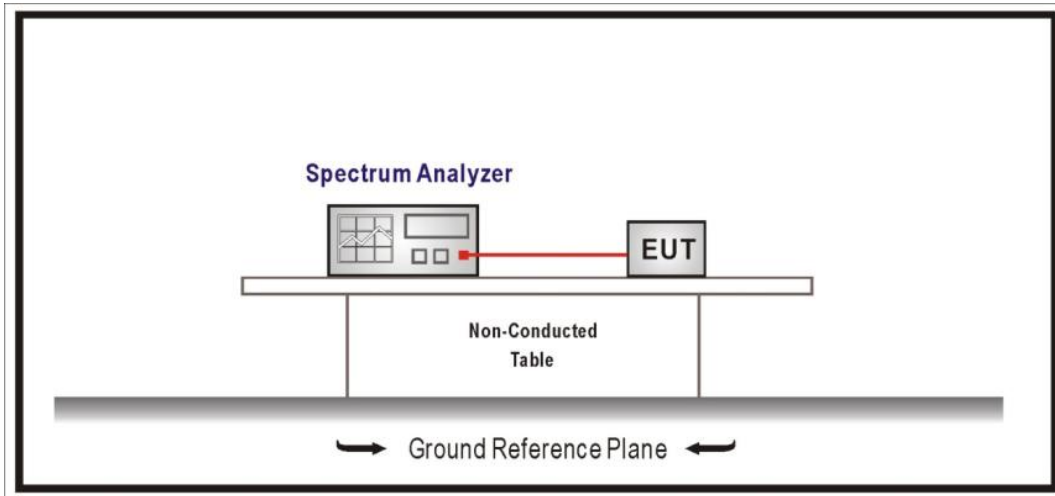

7.2. Test Limit

For frequency hopping systems operating in the 902 ~ 928 MHz band: if the 20 dB bandwidth of the hopping channel is less than 250 kHz, the system shall use at least 50 hopping frequencies and the average time of occupancy on any frequency shall not be greater than 0.4 seconds within a 20 second period; if the 20 dB bandwidth of the hopping channel is 250 kHz or greater, the system shall use at least 25 hopping frequencies and the average time of occupancy on any frequency shall not be greater than 0.4 seconds within a 10 second period. The maximum allowed 20 dB bandwidth of the hopping channel is 500 kHz.

Frequency hopping systems in the 2400 ~ 2483.5 MHz band shall use at least 15 channels. The average time of occupancy on any channel shall not be greater than 0.4 seconds within a period of 0.4 seconds multiplied by the number of hopping channels employed. Frequency hopping systems may avoid or suppress transmissions on a particular hopping frequency provided that a minimum of 15 channels are used.

Frequency hopping systems operating in the 5725 ~ 5850 MHz band shall use at least 75 hopping frequencies. The maximum 20 dB bandwidth of the hopping channel is 1 MHz. The average time of occupancy on any frequency shall not be greater than 0.4 seconds within a 30 second period.

7.3. Test Procedure

The EUT was setup according to ANSI C63.10: 2013 and tested according to FHSS test procedure of KDB 558074.

7.4. Test Result of Number of Hopping Frequency

Refer as Appendix E

8. Dwell Time

8.1. Test Setup

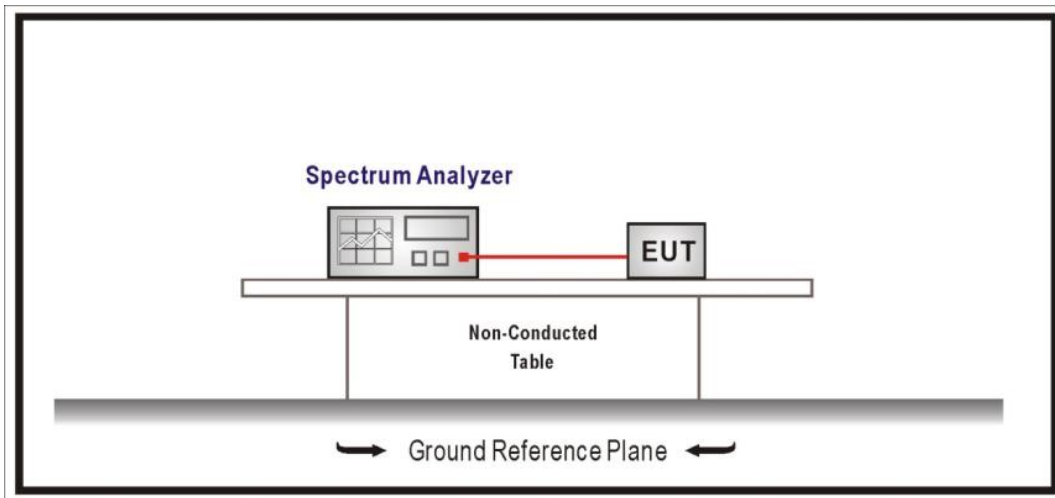

8.2. Test Limit

For frequency hopping systems operating in the 902-928 MHz band: if the 20 dB bandwidth of the hopping channel is less than 250 kHz, the system shall use at least 50 hopping frequencies and the average time of occupancy on any frequency shall not be greater than 0.4 seconds within a 20 second period; if the 20 dB bandwidth of the hopping channel is 250 kHz or greater, the system shall use at least 25 hopping frequencies and the average time of occupancy on any frequency shall not be greater than 0.4 seconds within a 10 second period.

For frequency hopping systems operating in the 2400-2483.5 MHz bands. The average time of occupancy on any channel shall not be greater than 0.4 seconds within a period of 0.4 seconds multiplied by the number of hopping channels employed.

For frequency hopping systems operating in the 5725-5850 MHz bands. The average time of occupancy on any frequency shall not be greater than 0.4 seconds within a 30 second period.

8.3. Test Procedure

The EUT was setup according to ANSI C63.10: 2013 and tested according to FHSS test procedure of KDB 558074.

8.4. Test Result of Dwell Time

Refer as Appendix F

9. Antenna Port Conducted Emission

9.1. Test Setup

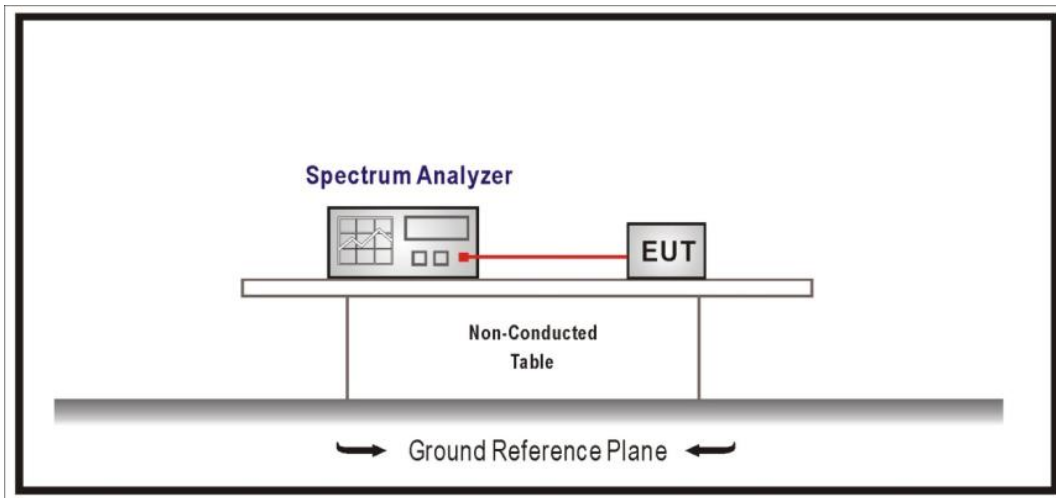

9.2. Test Limit

In any 100 kHz bandwidth outside the frequency band in which the spread spectrum or digitally modulated device is operating, the radio frequency power that is produced shall be at least 20 dB below that in the 100 kHz bandwidth within the band that contains the highest level of the desired power, based on either an RF conducted measurement, provided the transmitter demonstrates compliance with the peak conducted power limit.

9.3. Test Procedure

The EUT was setup according to ANSI C63.10: 2013 and tested according to FHSS test procedure of KDB 558074.

9.4. Test Result of Antenna Port Conducted Emission

Refer as Appendix G

10. Radiated Emission

10.1. Test Setup

9 kHz ~ 30 MHz

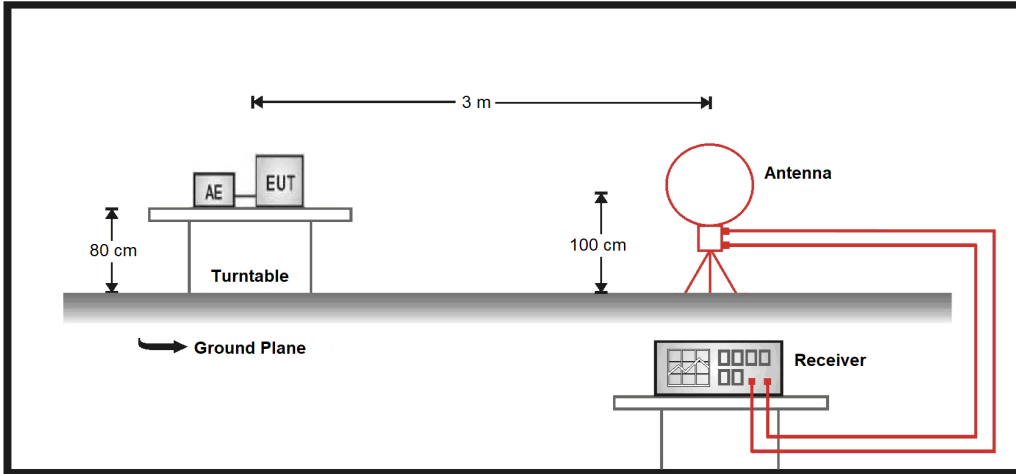

30 MHz ~ 1 GHz

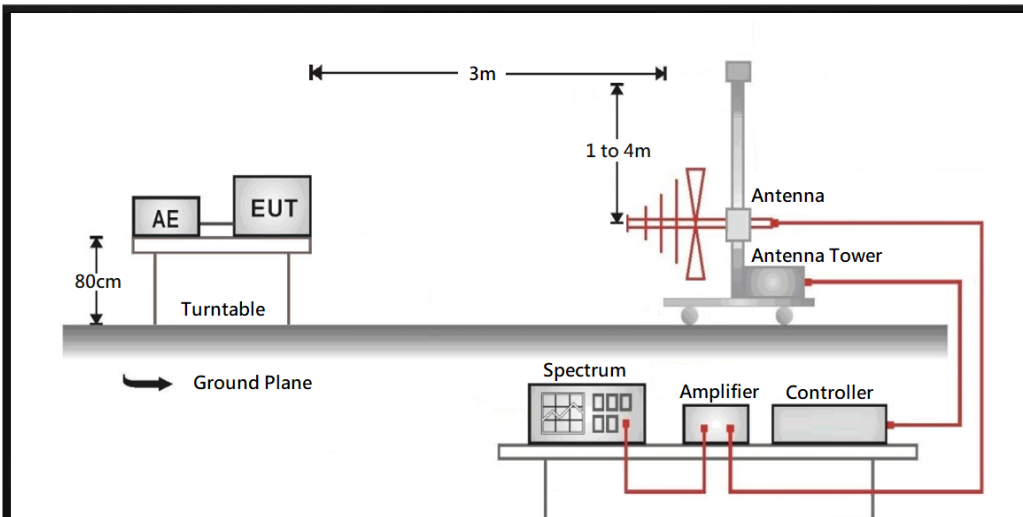

Above 1 GHz

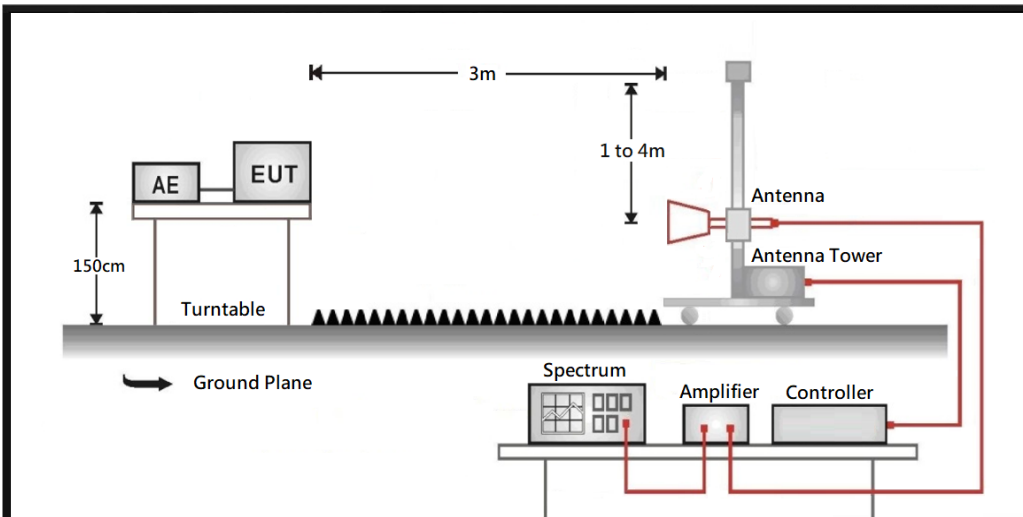

10.2. Test Limit

Frequency (MHz)	Field strength (uV/m)	Field strength (dBuV/m)	Measurement distance (m)
0.009 – 0.490	2400/F(kHz)	20 log (2400/F(kHz))	300
0.490 – 1.705	24000/F(kHz)	20 log (24000/F(kHz))	30
1.705 - 30	30	29.5	30
30 - 88	100	40	3
88 - 216	150	43.5	3
216 - 960	200	46	3
Above 960	500	54	3

Remarks:

1. Field strength (dBuV/m) = 20 log Field strength (uV/m)
2. In the Above Table, the tighter limit applies at the band edges.
3. Distance refers to the distance in meters between the measuring instrument antenna and the closed point of any part of the device or system.

10.3. Test Procedure

The EUT was setup according to ANSI C63.10: 2013 and tested according to FHSS test procedure of KDB 558074.

The EUT and its simulators are placed on a turn table which is 0.8 or 1.5 meter above ground. The turn table can rotate 360 degrees to determine the position of the maximum emission level.

The antenna can move up and down between 1 meter and 4 meters to find out the maximum emission level. Both horizontal and vertical polarization of the antenna are set on measurement. In order to find the maximum emission, all of the interface cables must be manipulated according to ANSI C63.10: 2013 on radiated measurement.

On any frequency or frequencies from 9 kHz (include The the lowest oscillator frequency generated within the device up to the 10th harmonic) to 1000 MHz, the limit shown are based on measuring equipment employing a quasi-peak detector function and on any frequency or frequencies above 1000 MHz the radiated limit shown are based upon the use of measurement instrumentation employing an average detector function. When average radiated emission measurement are included emission measurement below 1000 MHz, there also is a limit on the radio frequency emissions, as measured using instrumentation with a peak detector function, corresponding to 20 dB above the maximum permitted average limit.

The bandwidth below 1 GHz setting on the field strength meter is 120 kHz and above 1 GHz is 1 MHz.

10.4. Test Result of Radiated Emission

Refer as Appendix H