

## Industrial Internet Innovation Center (Shanghai) Co.,Ltd.

### SRD TEST REPORT

<b>PRODUCT</b>	Scout WiFi v1
<b>BRAND</b>	FeatherSnap
<b>MODEL</b>	FSBF001
<b>APPLICANT</b>	Bird Management OpCo LLC.
<b>FCC ID</b>	2BEUB-FSSCOUT1
<b>ISSUE DATE</b>	April 25, 2024
<b>STANDARD(S)</b>	FCC Part15C

Prepared by: *Tao Lingyan*



Reviewed by: *Yang Fan*

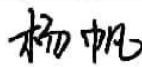

Approved by: *Zhang Min*



**CAUTION:**

*This report shall not be reproduced except in full without the written permission of the test laboratory and shall not be quoted out of context.*

## CONTENTS

<b>1. SUMMARY OF TEST REPORT .....</b>	<b>3</b>
1.1 TEST STANDARD(S) .....	3
1.2 REFERENCE DOCUMENTS.....	3
1.3 SUMMARY OF TEST RESULTS.....	3
1.4 DATA PROVIDED BY APPLICANT.....	4
<b>2. GENERAL INFORMATION OF THE LABORATORY .....</b>	<b>5</b>
2.1 TESTING LABORATORY .....	5
2.2 LABORATORY ENVIRONMENTAL REQUIREMENTS.....	5
2.3 PROJECT INFORMATION .....	5
<b>3. GENERAL INFORMATION OF THE CUSTOMER.....</b>	<b>6</b>
3.1 APPLICANT .....	6
3.2 MANUFACTURER .....	6
<b>4. GENERAL INFORMATION OF THE PRODUCT.....</b>	<b>7</b>
4.1 PRODUCT DESCRIPTION FOR EQUIPMENT UNDER TEST (EUT).....	7
4.2 INTERNAL IDENTIFICATION OF AE USED DURING THE TEST.....	7
4.3 ADDITIONAL INFORMATION .....	8
<b>5. TEST CONFIGURATION INFORMATION .....</b>	<b>9</b>
5.1 LABORATORY ENVIRONMENTAL CONDITIONS.....	9
5.2 TEST EQUIPMENTS UTILIZED.....	9
5.3 MEASUREMENT UNCERTAINTY .....	11
<b>6. TEST RESULTS .....</b>	<b>13</b>
6.1 DUTY CYCLE .....	13
6.2 OUTPUT POWER-CONDUCTED .....	16
6.3 PEAK POWER SPECTRAL DENSITY .....	20
6.4 OCCUPIED 6dB BANDWIDTH.....	23
6.5 99% OCCUPIED BANDWIDTH.....	26
6.6 BAND EDGES COMPLIANCE.....	30
6.7 TRANSMITTER SPURIOUS EMISSION-CONDUCTED.....	33
6.8 TRANSMITTER SPURIOUS EMISSION-RADIATED .....	40
6.9 AC POWERLINE CONDUCTED EMISSION .....	62
<b>ANNEX A: REVISED HISTORY .....</b>	<b>64</b>
<b>ANNEX B: ACCREDITATION CERTIFICATE.....</b>	<b>65</b>



## 1. Summary of Test Report

### 1.1 Test Standard(s)

No.	Test Standard	Title	Version
1	FCC Part15C	FCC CFR 47, Part 15, Subpart C: 15.205 Restricted bands of operation; 15.209 Radiated emission limits, general requirements; 15.247 Operation within the bands 902-928MHz, 2400-2483.5MHz, and 5725-5850MHz.	--

### 1.2 Reference Documents

No.	Test Standard	Title	Version
1	ANSI C63.10	American National Standard of Procedures for Compliance Testing of Unlicensed Wireless Devices	2013
2	KDB 558074 D01 15.247 Meas Guidance v05r02	Guidance for Performing Compliance Measurements on Frequency Hopping Spread Spectrum systems (DSS) Operating Under §15.247	--

Note: KDB 558074 D01 15.247 Meas Guidance v05r02 is not A2LA certified.

### 1.3 Summary of Test Results

No.	Measurement Items	FCC Rules	Verdict
1	Maximum Peak Output Power	15.247(b)	Pass
2	Peak Power Spectral Density	15.247(e)	Pass
3	6dB Occupied Bandwidth	15.247(a)	Pass
4	99% Occupied Bandwidth	N/A	Pass
5	Band Edges Compliance	15.247(d)	Pass
6	Transmitter Spurious Emission-Conducted	15.247(d)	Pass
7	Transmitter Spurious Emission-Radiated	15.247/15.205/15.209	Pass
8	AC Powerline Conducted Emission	15.207	N/A <sup>Note 3</sup>
9	Antenna requirement	15.203/15.247(c)	Pass <sup>Note 2</sup>

**Note1:**

The FSBF001 manufactured by Bird Management OpCo LLC.is a new products for testing. Industrial Internet Innovation Center (Shanghai) Co., Ltd. only performed test cases which identified with Pass/Fail/Inc result in section 1.3.

Industrial Internet Innovation Center (Shanghai) Co., Ltd. has verified that the compliance of the tested device specified in section 4 of this test report is successfully evaluated according to the procedure and test methods as defined in type certification requirement listed in section 1 of this test report.

**Note2:**

2.4G WLAN used a FPC antenna with max Gain 4.26 dBi that complied with 15.203 Requirements

**Note3:**

Because the EUT is battery powered or charged by solar energy, adapter-related tests cannot be performed. Therefore, this test item is not applicable.

**Note4:**

Both internal and external antenna data are verified, and all conducted data is reported based on the worst mode of the internal antenna

**Note5:**

All the test data for each data were verified, but only the worst case was reported.

**1.4 Data Provided by Applicant**

No.	Item(s)	Data
1	Internal antenna gain of EUT	3.83 dBi
2	External antenna gain of EUT	4.26 dBi

Note: The data of antenna gain is provided by the Antenna specification may affect the validity of the test results in this report, and the impact and consequences of this shall be undertaken by the customer.



## 2. General Information of The Laboratory

### 2.1 Testing Laboratory

Lab Name	Industrial Internet Innovation Center (Shanghai) Co.,Ltd.
Address	Building 4, No. 766, Jingang Road, Pudong, Shanghai, China
Telephone	021-68866880
FCC Registration No.	708870
FCC Designation No.	CN1364

### 2.2 Laboratory Environmental Requirements

Temperature	15°C~35°C
Relative Humidity	86kPa~106kPa
Atmospheric Pressure	86kPa~106kPa

### 2.3 Project Information

Project Manager	Xu Yuting
Test Date	January 30, 2024 to April 18, 2024

### 3. General Information of The Customer

#### 3.1 Applicant

Company	Bird Management OpCo LLC.
Address	110 N. Sunset Blvd
Telephone	8122366730

#### 3.2 Manufacturer

Company	Bird Management OpCo LLC.
Address	110 N. Sunset Blvd
Telephone	8122366730

## 4. General Information of The Product

### 4.1 Product Description for Equipment under Test (EUT)

Product Name	Scout WiFi v1
Model name	FSBF001
Date of Receipt	January 30, 2024
EUT ID*	S03aa/S07aa
SN/IMEI	S03aa/S07aa:N/A
Supported Radio Technology and Bands	BLE 802.11b/g/n
Hardware Version	P1
Software Version	1.0
FCC ID	2BEUB-FSSCOUT1

NOTE1: EUT ID is the internal identification code of the laboratory.

NOTE2: Samples in the test report are provided by the customer. The test results are only applicable to the samples received by the laboratory.

### 4.2 Internal Identification of AE used during the test

AE ID*	Description	Model	SN/Remark
AE1	RF Cable	N/A	N/A
CA04	Battery	N/A	N/A
CA01	Adapter	GLH50Z1000	N/A
UB03	Connecting Cable	N/A	N/A

NOTE1: AE ID is the internal identification code of the laboratory.



### 4.3 Additional Information

WLAN Frequency	2412MHz-2462MHz
WLAN Channel	CH1-11
WLAN type of modulation	802.11b: DSSS 802.11g/n: OFDM

Test frequency list:

BW_20M	Channel	1	6	11
	Freq. (MHz)	2412	2437	2462

Note: This report is for 2.4G WLAN only.



## 5. Test Configuration Information

### 5.1 Laboratory Environmental Conditions

#### 5.1.1 Permanent Facilities

Relative Humidity	Min. = 45 %, Max. = 55 %		
Atmospheric Pressure	101kPa		
Temperature	Normal	Minimum	Maximum
	25°C	-25°C	55°C
Working Voltage of EUT	Normal	Minimum	Maximum
	3.6V	3.5V	4.2V

### 5.2 Test Equipments Utilized

#### 5.2.1 Conducted Test System

No.	Name	Model	S/N	SW Version	HW Version	Manufacturer	Cal. Date	Cal. Interval
1	Test Software	TS1120	10727	V3.2.22	N/A	Tonsce nd	N/A	N/A
2	Automatic control unit	JS0806-2	2218060623	N/A	N/A	Tonsce nd	2023-05-06	1 Year
3	Wireless communication comprehensive tester	CMW500	164865	V3.8.12	N/A	R&S	2023-07-26	1 Year
4	Spectrum Analyzer	FSQ40	200063	V4.75	N/A	R&S	2023-10-16	1 Year
5	Analog Signal Generator	SMF	104770	V3.0.13.0-2.20.530.15.4	N/A	R&S	2023-10-16	1 year
6	Vector Signal Generator	SMCV100B	103691	V5.00.122.24	N/A	R&S	2023-07-27	1 Year
7	Programmable Power Supply	Keithley 2303	4039070	N/A	N/A	Keithley	2023-06-23	1 Year
8	Temperature box	B-TF-107C	BTF107C-201804107	N/A	N/A	Boyi	2023-06-28	1 Year
9	Network test unit AP	GT-AXE11000	N2IG0X401637KWF	V3.0.0.4.386_45940	N/A	ASUS	N/A	N/A
10	Vector Signal Generator	SMBV100A	257904	V4.15.125.49	N/A	R&S	2023-10-16	1 Year

**5.2.2 Radiated Emission Test System**

No	Name	Model	S/N	SW Version	HW Version	Manufacturer	Cal. Date	Cal. Interval
1	Universal Radio Communication Tester	CMU200	123126	V5.2.1	B12	R&S	2023-10-16	1 Year
2	Universal Radio Communication Tester	CMW500	104178	V3.7.20	1206.0600.00	R&S	2023-10-16	1 Year
3	EMI Test Receiver	ESU40	100307	V5.1-24-3	01	R&S	2023-12-19	1 Year
4	Trilog Antenna	VULB9162	00426	N/A	N/A	Schwarzbeck	2023-07-18	1 year
5	Double Ridged Guide Antenna	ETS-3117	00135885	N/A	N/A	ETS	2023-03-23	2 years
6	EMI Test Software	EMC32 V10.35.02	N/A	N/A	N/A	R&S	N/A	N/A
7	Horn Antenna	3160-09	LM6321	N/A	N/A	R&S	2023-07-16	1 Year
8	Horn Antenna	3160-10	LM5942	N/A	N/A	R&S	2023-07-16	1 Year
9	Loop Antenna	AL-130R	121083	N/A	N/A	COM-POWER	2023-9-13	1 Year
10	Preamplifier	SCU08F1	8320024	N/A	N/A	R&S	2023-10-16	1 Year
11	Preamplifier	SCU18	10155	N/A	N/A	R&S	2023-10-16	1 Year
12	Preamplifier	SCU26	10025	N/A	N/A	R&S	2023-10-16	1 Year
13	Preamplifier	SCU40	10020	N/A	N/A	R&S	2023-10-16	1 Year
14	2-Line V-Network	ENV216	101380	N/A	N/A	R&S	2023-12-19	1 Year
15	EMI Test Software	EMC32 V10.35.02	N/A	N/A	N/A	R&S	N/A	N/A
16	Test Receiver	ESCI	101235	V5.1-24-3	0	R&S	2023-12-19	1 Year
17	Antenna Tower	TPMDC-LF	N/A	N/A	N/A	Top Precision	N/A	N/A
18	Antenna Tower	TPMDC-HF	N/A	N/A	N/A	Top Precision	N/A	N/A



### 5.2.3 Test Environment

**Shielding Room1** (6.0 meters×3.0 meters×2.7 meters) did not exceed following limits along the conducted RF performance testing:

Temperature	Min. = 15 °C, Max. = 35 °C
Relative humidity	Min. = 20 %, Max. = 75 %
Shielding effectiveness	> 100 dB
Ground system resistance	< 0.5 Ω
Temperature	Min. = 15 °C, Max. = 35 °C

**Control room** did not exceed following limits along the EMC testing:

Temperature	Min. = 15 °C, Max. = 35 °C
Relative humidity	Min. =30 %, Max. = 60 %
Shielding effectiveness	> 100 dB
Electrical insulation	> 10 kΩ
Ground system resistance	< 0.5 Ω

**Fully-anechoic chamber1** (9.8 meters×6.7 meters×6.7 meters) did not exceed following limits along the EMC testing:

Temperature	Min. = 15 °C, Max. = 35 °C
Relative humidity	Min. = 25 %, Max. = 75 %
Shielding effectiveness	> 100 dB
Electrical insulation	> 10 kΩ
Ground system resistance	< 0.5 Ω
VSWR	Between 0 and 6 dB, from 1GHz to 18GHz
Site Attenuation Deviation	Between -4 and 4 dB,30MHz to 1GHz

### 5.3 Measurement Uncertainty

Measurement Uncertainty of Conduction test

Item(s)	Frequency range	Confidence Level	Uncertainty
DTS Bandwidth	2400–2483.5MHz	95%	±1.9%
Maximum Conducted Output Power	2400–2483.5MHz	95%	± 1.18 dB
Maximum Power Spectral Density Level	2400–2483.5MHz	95%	±0.98 dB
Band-edge Compliance	2400–2483.5MHz	95%	±1.21dB
Unwanted Emissions In Non-restricted Freq Bands	9kHz-7GHz	95%	9kHz-7GHz:±1.21dB

	7GHz-40GHz	95%	7GHz-40GHz:±3.31dB
--	------------	-----	--------------------

## Measurement Uncertainty of Radiation test

Measurement Items	Uncertainty(dB)
Radiated Emission 30MHz-1000MHz	±5.10
Radiated Emission 1000MHz-18000MHz	±5.66
Radiated Emission 18000MHz-40000MHz	±5.22
AC Powerline Conducted Emission	±4.38

Note: This uncertainty represents an expanded uncertainty expressed at approximately the 95% confidence level using a coverage factor of k=2.



## 6. Test Results

### 6.1 Duty cycle

#### 6.1.1 Measurement Limit

Standard	Limit (dBm)
FCC 47 Part 15.247(b)	NA

#### 6.1.2 Test Procedure

This measurement is according to ANSI C63.10 clause 11.6

Measurements of duty cycle and transmission duration shall be performed using one of the following techniques:

- a) A diode detector and an oscilloscope that together have a sufficiently short response time to permit accurate measurements of the ON and OFF times of the transmitted signal.
- b) The zero-span mode on a spectrum analyzer or EMI receiver if the response time and spacing between bins on the sweep are sufficient to permit accurate measurements of the ON and OFF times of the transmitted signal:
  - 1) Set the center frequency of the instrument to the center frequency of the transmission.
  - 2) Set  $RBW \geq OBW$  if possible; otherwise, set RBW to the largest available value.
  - 3) Set  $VBW \geq RBW$ . Set detector = peak or average.
  - 4) The zero-span measurement method shall not be used unless both RBW and VBW are  $> 50/T$  and the number of sweep points across duration T exceeds 100. (For example, if VBW and/or RBW are limited to 3 MHz, then the zero-span method of measuring the duty cycle shall not be used if  $T \leq 16.7 \mu s$ .)

#### 6.1.3 Measurement Results

TestMode	Antenna	Frequency[MHz]	Transmission Duration [ms]	Transmission Period [ms]	Duty Cycle [%]	Factor
11B	Ant1	2412	5.01	6.15	81.46	0.89
11B	Ant1	2437	5.01	6.15	81.46	0.89
11B	Ant1	2462	5.01	6.15	81.46	0.89
11G	Ant1	2412	0.81	1.95	41.54	3.82
11G	Ant1	2437	0.81	1.95	41.54	3.82
11G	Ant1	2462	0.81	1.95	41.54	3.82
11N20SISO	Ant1	2412	0.75	1.89	39.68	4.01
11N20SISO	Ant1	2437	0.75	1.89	39.68	4.01
11N20SISO	Ant1	2462	0.75	1.89	39.68	4.01

## Test Graphs

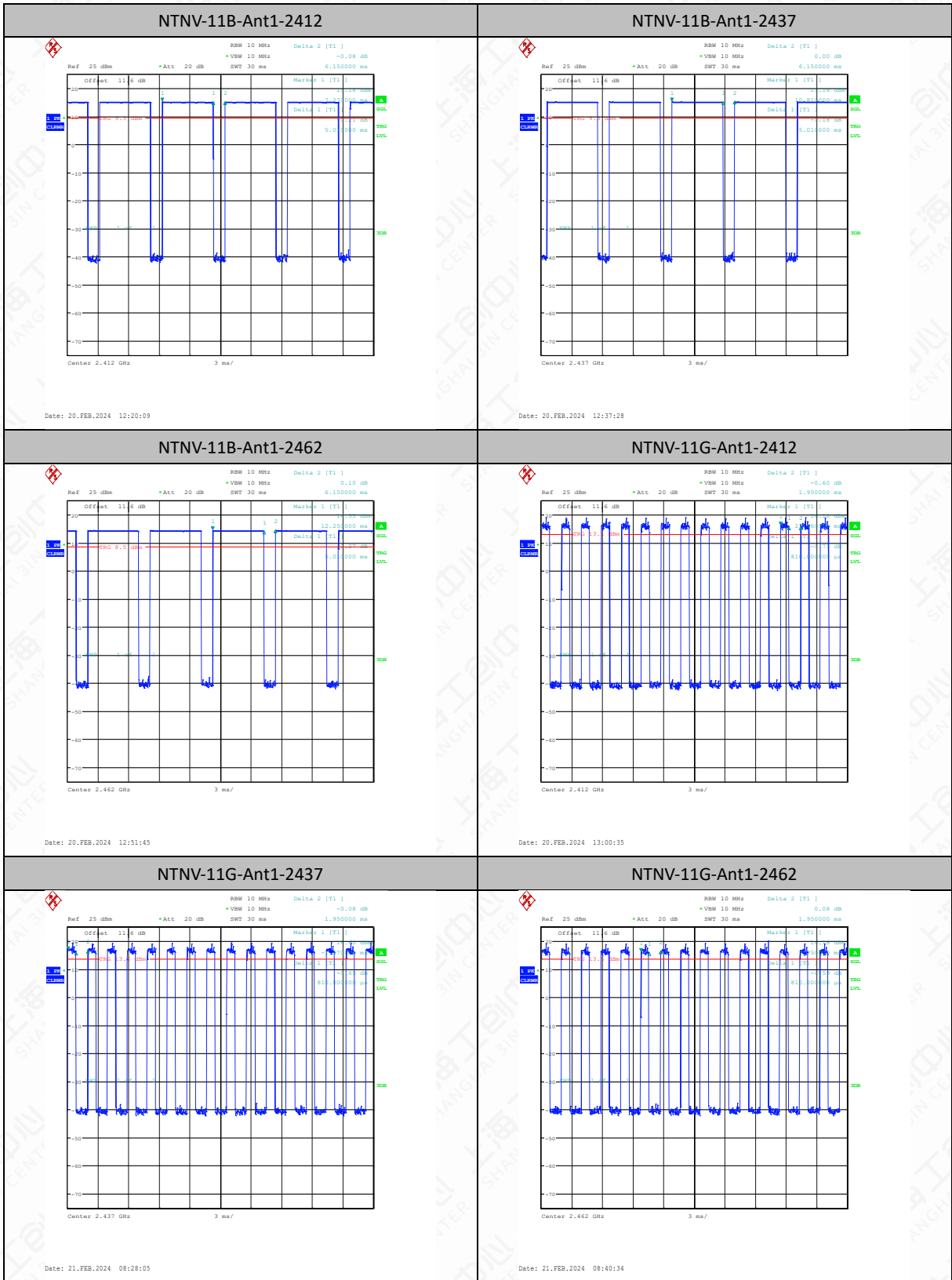



NTNV-11N20SISO-Ant1-2412	NTNV-11N20SISO-Ant1-2437
NTNV-11N20SISO-Ant1-2462	/
	/

## 6.2 Output Power-Conducted

### 6.2.1 Measurement Limit

Standard	Limit (dBm)
FCC 47 Part 15.247(b)(3)	<30
Note: Except as shown in paragraphs (b)(3) (i), (ii) and (iii) of this section, if transmitting antennas of directional gain greater than 6 dBi are used the peak output power from the intentional radiator shall be reduced below the stated values in paragraphs (b)(1) or (b)(2) of this section, as appropriate, by the amount in dB that the directional gain of the antenna exceeds 6 dBi.	

### 6.2.2 Test Procedure

The measurement is according to ANSI C63.10 clause 11.9.

1. Measure the duty cycle D of the transmitter output signal as described in 11.6.
2. Set span to at least 1.5 times the OBW.
3. Set RBW = 1% to 5% of the OBW, not to exceed 1 MHz.
4. Set VBW  $\geq [3 \times \text{RBW}]$ .
5. Number of points in sweep  $\geq [2 \times \text{span} / \text{RBW}]$ . (This gives bin-to-bin spacing  $\leq \text{RBW} / 2$ , so that narrowband signals are not lost between frequency bins.)
6. Sweep time = auto.
7. Detector = RMS (i.e., power averaging), if available. Otherwise, use the sample detector mode.
8. Do not use sweep triggering. Allow the sweep to “free run.”
9. Trace average at least 100 traces in power averaging (rms) mode; however, the number of traces to be averaged shall be increased above 100 as needed such that the average accurately represents the true average over the ON and OFF periods of the transmitter.
10. Compute power by integrating the spectrum across the OBW of the signal using the instrument’s band power measurement function with band limits set equal to the OBW band edges. If the instrument does not have a band power function, then sum the spectrum levels (in power units) at intervals equal to the RBW extending across the entire OBW of the spectrum.
11. Add  $[10 \log (1 / D)]$ , where D is the duty cycle, to the measured power to compute the average power during the actual transmission times (because the measurement represents an average over both the ON and OFF times of the transmission). For example, add  $[10 \log (1/0.25)] = 6 \text{ dB}$  if the duty cycle is 25%.



## 6.2.3 Test setup

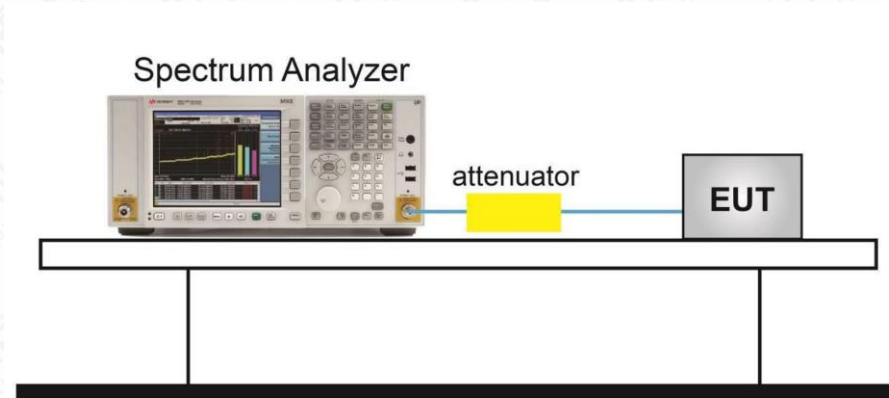

## 6.2.4 Measurement Results

TestMode	Antenna	Frequency [MHz]	Set Power	Peak Power[dBm]	Conducted Limit[dBm]	Verdict
11B	Ant1	2412	NA	11.38	≤30.00	PASS
11B	Ant1	2437	NA	11.92	≤30.00	PASS
11B	Ant1	2462	NA	11.95	≤30.00	PASS
11G	Ant1	2412	NA	11.91	≤30.00	PASS
11G	Ant1	2437	NA	12.20	≤30.00	PASS
11G	Ant1	2462	NA	12.04	≤30.00	PASS
11N20SISO	Ant1	2412	NA	11.93	≤30.00	PASS
11N20SISO	Ant1	2437	NA	11.77	≤30.00	PASS
11N20SISO	Ant1	2462	NA	11.67	≤30.00	PASS

Note:

- 1.The Duty Cycle Factor is compensated in the graph.
2. In the graph, the Center frequency = (Low frequency of 99% OBW + High frequency of 99% OBW) /2.

## Test Graphs Peak

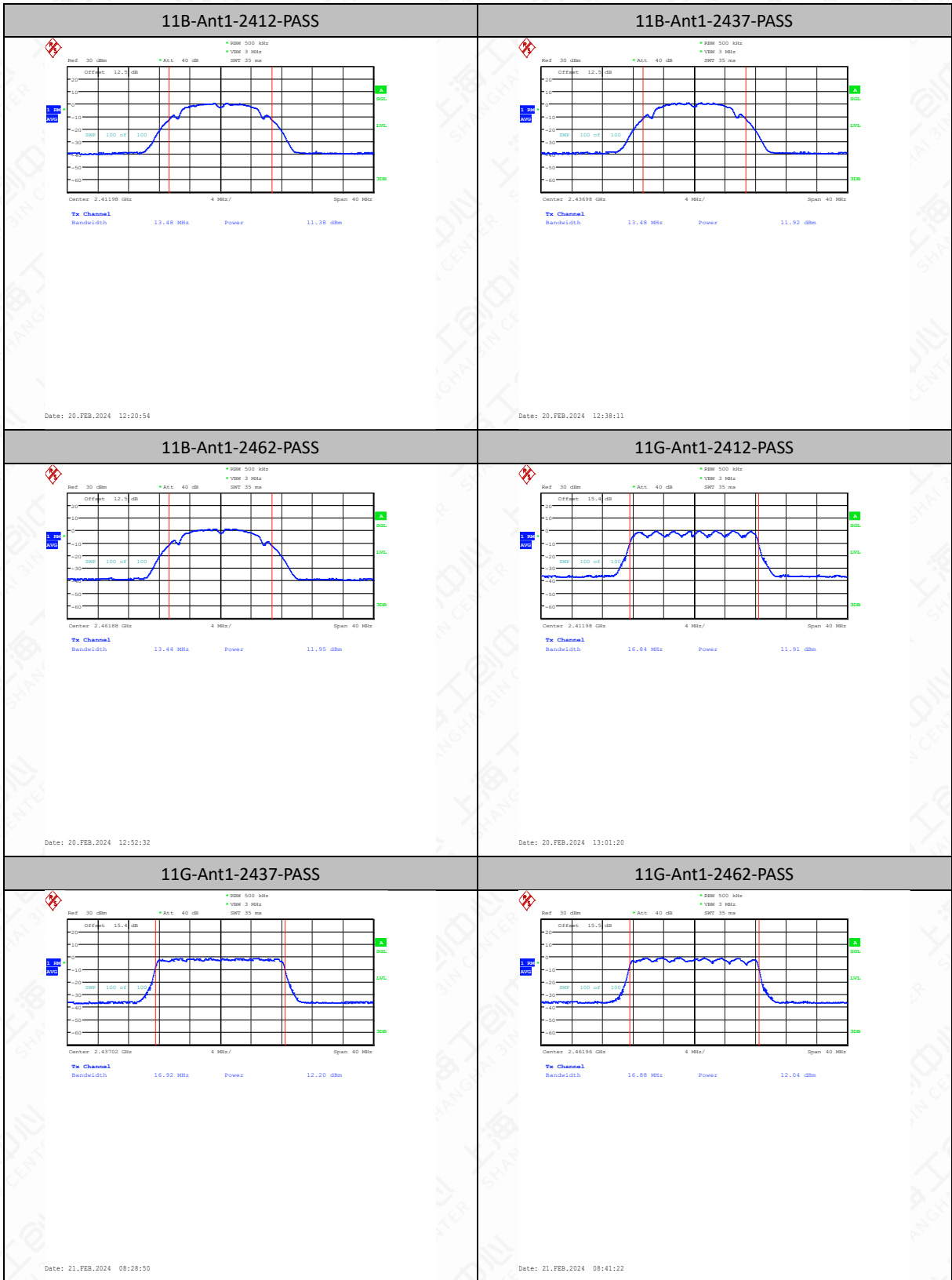

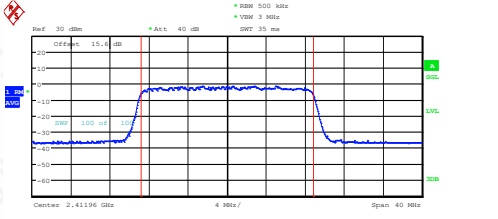
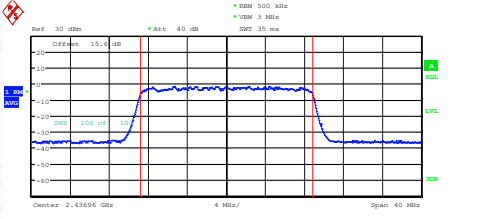
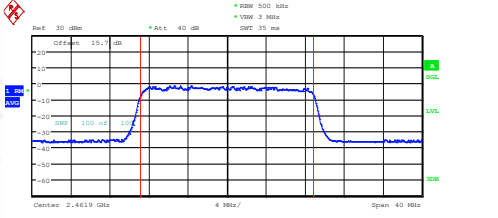

11N20SISO-Ant1-2412-PASS	11N20SISO-Ant1-2437-PASS
 <p>Center: 2.41196 GHz    4 MHz/    Span: 40 MHz</p> <p>Tx Channel Bandwidth: 17.68 MHz    Power: 11.93 dBm</p> <p>Date: 21.FEB.2024 08:54:10</p>	 <p>Center: 2.43696 GHz    4 MHz/    Span: 40 MHz</p> <p>Tx Channel Bandwidth: 17.68 MHz    Power: 11.77 dBm</p> <p>Date: 21.FEB.2024 09:32:38</p>
11N20SISO-Ant1-2462-PASS	/
 <p>Center: 2.4619 GHz    4 MHz/    Span: 40 MHz</p> <p>Tx Channel Bandwidth: 17.72 MHz    Power: 11.67 dBm</p> <p>Date: 21.FEB.2024 09:46:05</p>	<p>/</p>

### 6.3 Peak Power Spectral Density

#### 6.3.1 Measurement Limit

Standard	Limit
FCC 47 Part 15.247(e)	$\leq 8\text{dBm}/3\text{ KHz}$

#### 6.3.2 Test procedures

The measurement is according to ANSI C63.10 clause 11.10.

The output power of EUT was connected to the spectrum analyzer. The path loss was compensated to the results for each measurement.

1. Measure the duty cycle (D) of the transmitter output signal as described in 11.6.
2. Set instrument center frequency to DTS channel center frequency.
3. Set span to at least 1.5 times the OBW.
4. Set RBW to:  $3\text{ kHz} \leq \text{RBW} \leq 100\text{ kHz}$ .
5. Set VBW  $\geq [3 \times \text{RBW}]$ .
6. Detector = power averaging (rms) or sample detector (when rms not available).
7. Ensure that the number of measurement points in the sweep  $\geq [2 \times \text{span} / \text{RBW}]$ .
8. Sweep time = auto couple.
9. Do not use sweep triggering; allow sweep to “free run.”
10. Employ trace averaging (rms) mode over a minimum of 100 traces.
11. Use the peak marker function to determine the maximum amplitude level.
12. Add  $[10 \log (1 / D)]$ , where D is the duty cycle measured in step a), to the measured PSD to compute the average PSD during the actual transmission time.
13. If measured value exceeds requirement specified by regulatory agency, then reduce RBW (but no less than 3 kHz) and repeat (note that this may require zooming in on the emission of interest and reducing the span to meet the minimum measurement point requirement as the RBW is reduced).

#### 6.3.3 Test setup

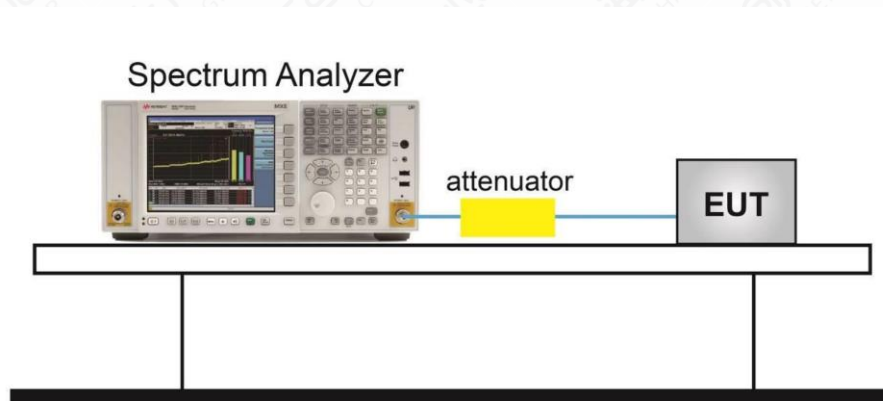



## 6.3.4 Measurement Result

TestMode	Antenna	Frequency[MHz]	Result[dBm/3kHz]	Limit[dBm/3kHz]	Verdict
11B	Ant1	2412	-6.38	≤8.00	PASS
11B	Ant1	2437	-5.51	≤8.00	PASS
11B	Ant1	2462	-6.90	≤8.00	PASS
11G	Ant1	2412	-7.58	≤8.00	PASS
11G	Ant1	2437	-5.46	≤8.00	PASS
11G	Ant1	2462	-7.56	≤8.00	PASS
11N20SISO	Ant1	2412	-6.71	≤8.00	PASS
11N20SISO	Ant1	2437	-5.94	≤8.00	PASS
11N20SISO	Ant1	2462	-7.82	≤8.00	PASS

Note:

1.The Duty Cycle Factor is compensated in the graph.

Test Graphs

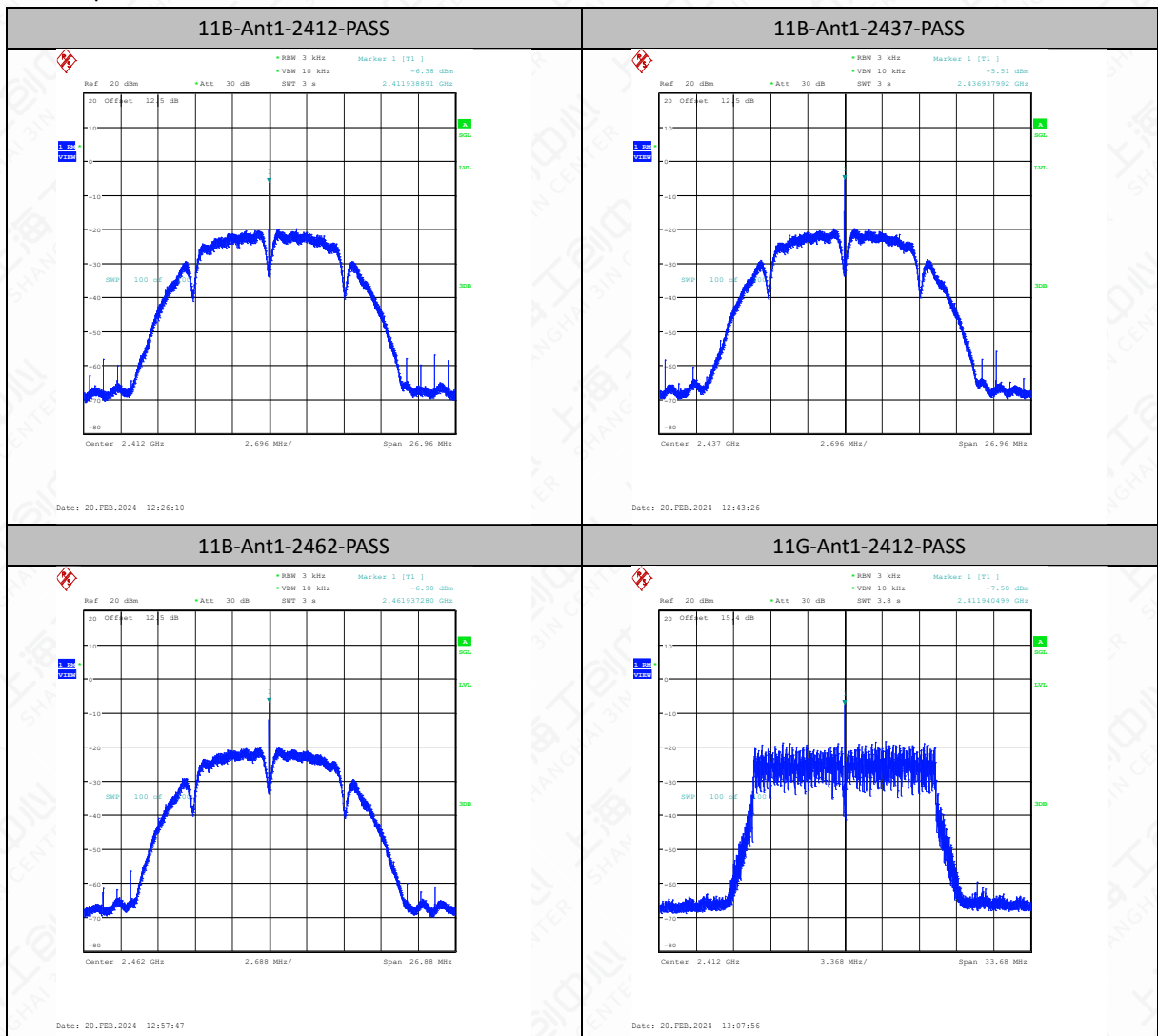

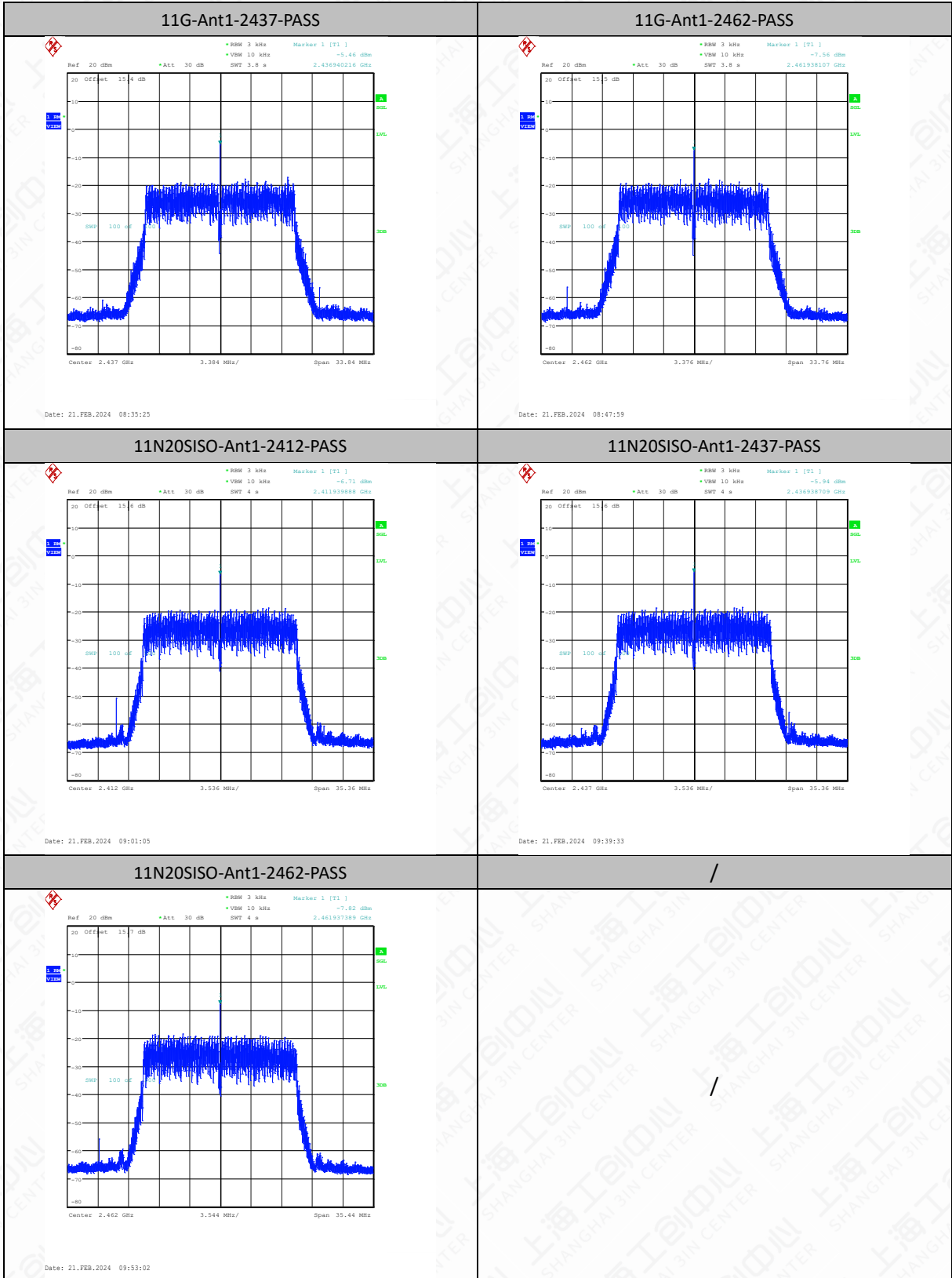



## 6.4 Occupied 6dB Bandwidth

### 6.4.1 Measurement Limit

Standard	Limit(KHz)
FCC 47 Part 15.247(a) (2)	≥500KHz

### 6.4.2 Test procedures

1. The output power of EUT was connected to the spectrum analyzer. The path loss was compensated to the results for each measurement.
2. Enable EUT transmitter maximum power continuously.
3. Set RBW = 100 kHz.
4. Set the VBW ≥ [3 × RBW].
5. Detector = peak.
6. Trace mode = max hold.
7. Sweep = auto couple.
8. Allow the trace to stabilize.
9. Measure the maximum width of the emission that is constrained by the frequencies associated with the two outermost amplitude points (upper and lower frequencies) that are attenuated by 6 dB relative to the maximum level measured in the fundamental emission.

### 6.4.3 Test Setup

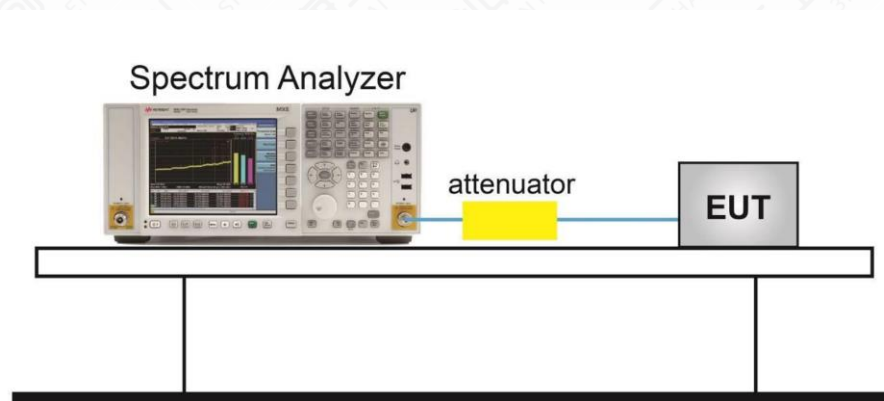

## 6.4.4 Measurement Results

TestMode	Antenna	Frequency[MHz]	DTS BW [MHz]	FL[MHz]	FH[MHz]	Limit[MHz]	Verdict
11B	Ant1	2412	9.52	2406.96	2416.48	0.5	PASS
11B	Ant1	2437	10.08	2431.92	2442.00	0.5	PASS
11B	Ant1	2462	10.08	2456.92	2467.00	0.5	PASS
11G	Ant1	2412	16.36	2403.76	2420.12	0.5	PASS
11G	Ant1	2437	16.32	2428.80	2445.12	0.5	PASS
11G	Ant1	2462	16.32	2453.76	2470.08	0.5	PASS
11N20SISO	Ant1	2412	16.96	2403.52	2420.48	0.5	PASS
11N20SISO	Ant1	2437	16.92	2428.56	2445.48	0.5	PASS
11N20SISO	Ant1	2462	17.16	2453.20	2470.36	0.5	PASS

Test graphs as below

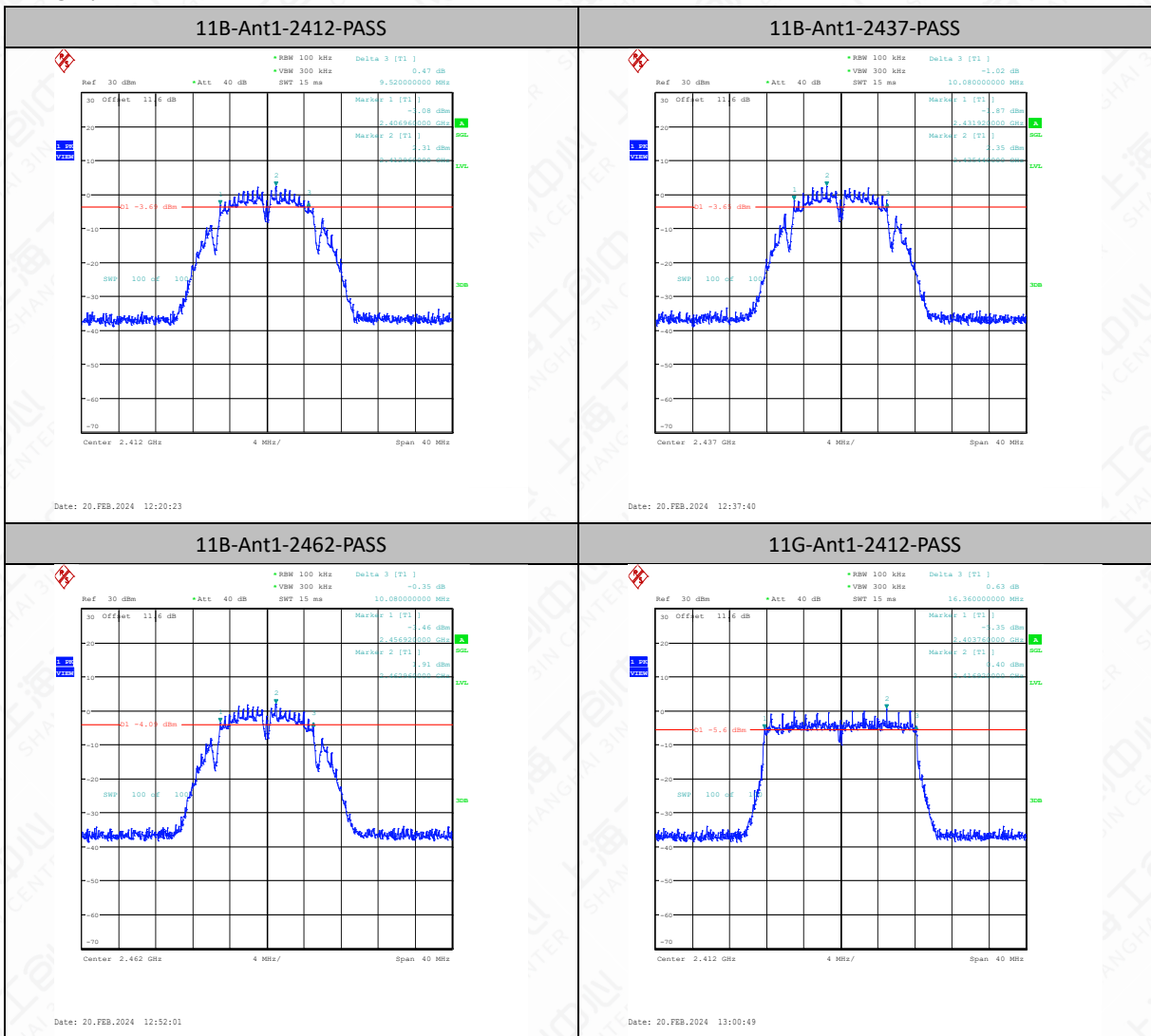



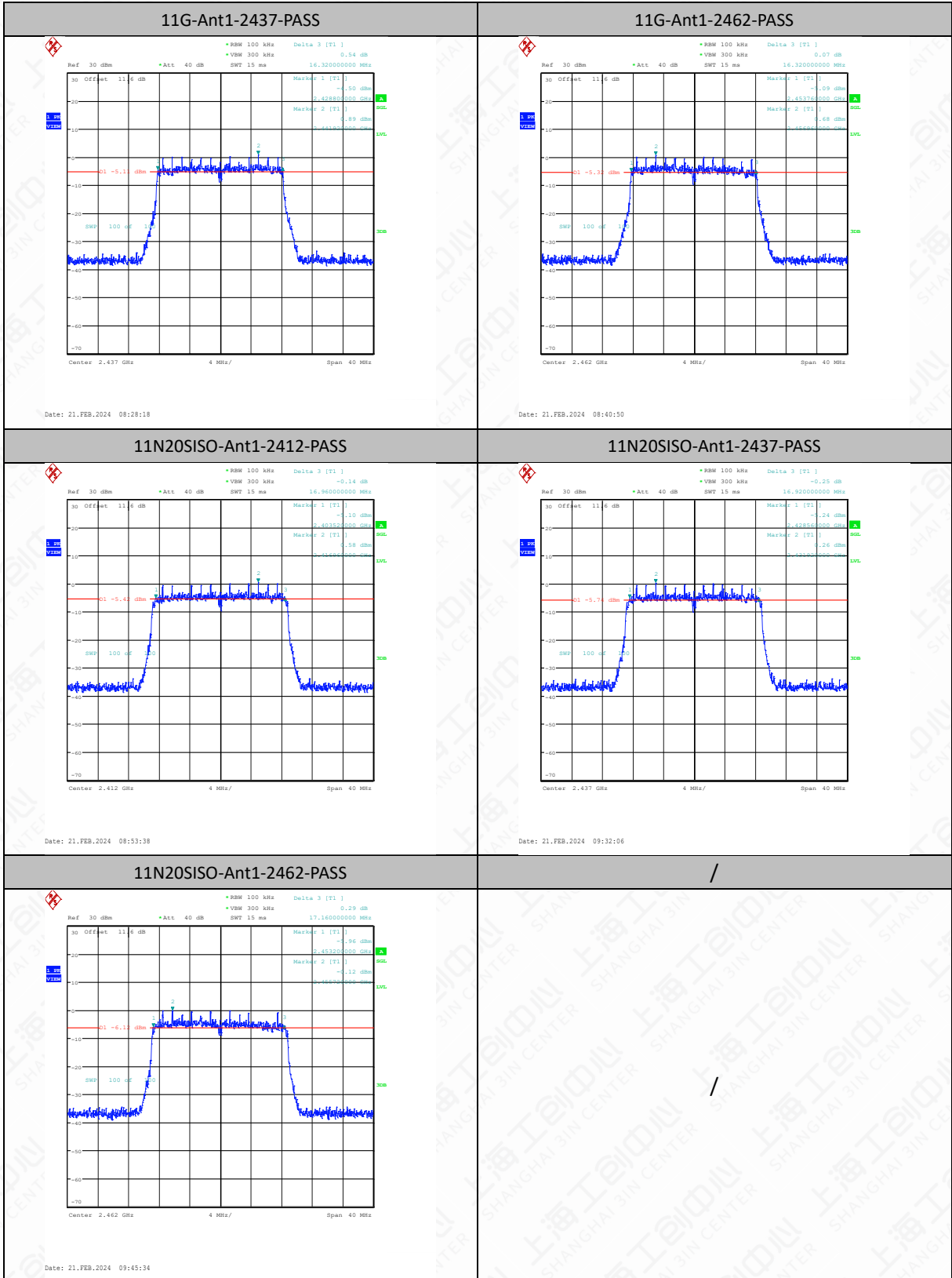

## 6.5 99% Occupied Bandwidth

### 6.5.1 Measurement Limit

Standard	Limit
N/A	N/A

### 6.5.2 Test procedures

The measurement is according to ANSI C63.10 clause 6.9.3.

1. The output power of EUT was connected to the spectrum analyzer. The path loss was compensated to the results for each measurement.
2. Enable EUT transmitter maximum power continuously.
3. Set RBW shall be in the range of 1% to 5% of the OBW.
4. Set the VBW  $\geq [3 \times \text{RBW}]$ .
5. Detector = peak.
6. Trace mode = max hold.
7. Sweep = auto couple.
8. Allow the trace to stabilize.
9. The occupied bandwidth is the frequency bandwidth such that, below its lower and above its upper frequency limits, the mean powers are each equal to 0.5% of the total mean power of the given emission.

### 6.5.3 Test setup

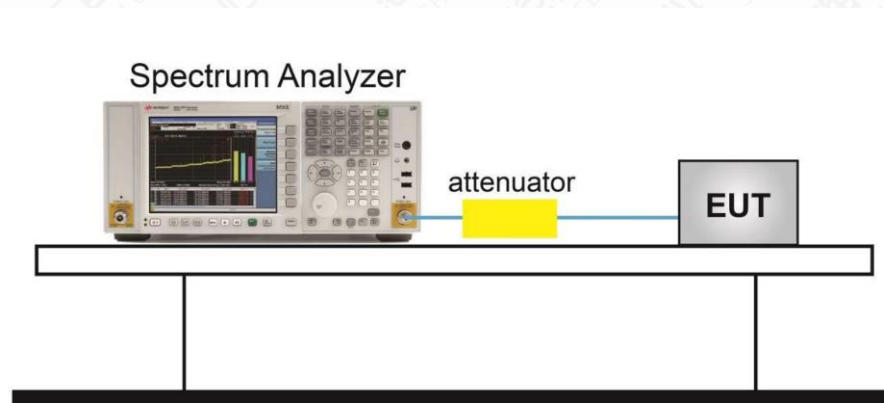



## 6.5.4 Measurement Result

TestMode	Antenna	Channel Frequency[MHz]	OCB [MHz]	FL[MHz]	FH[MHz]	Limit[MHz]	Verdict
11B	Ant1	2412	13.48	2405.2400	2418.7200	---	---
11B	Ant1	2437	13.48	2430.2400	2443.7200	---	---
11B	Ant1	2462	13.44	2455.1600	2468.6000	---	---
11G	Ant1	2412	16.84	2403.5600	2420.4000	---	---
11G	Ant1	2437	16.92	2428.5600	2445.4800	---	---
11G	Ant1	2462	16.88	2453.5200	2470.4000	---	---
11N20SISO	Ant1	2412	17.68	2403.1200	2420.8000	---	---
11N20SISO	Ant1	2437	17.68	2428.1200	2445.8000	---	---
11N20SISO	Ant1	2462	17.72	2453.0400	2470.7600	---	---

graphs as below

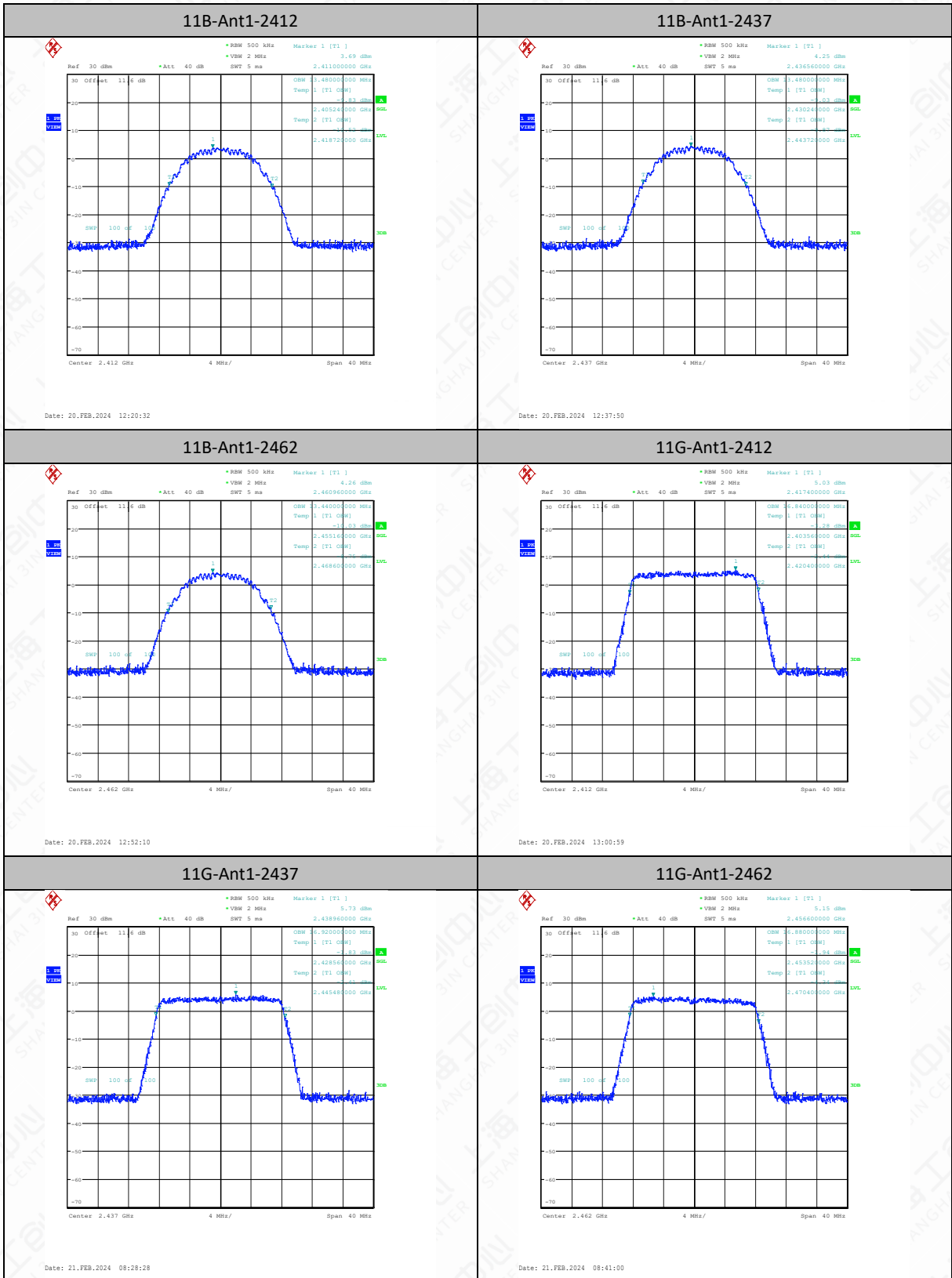



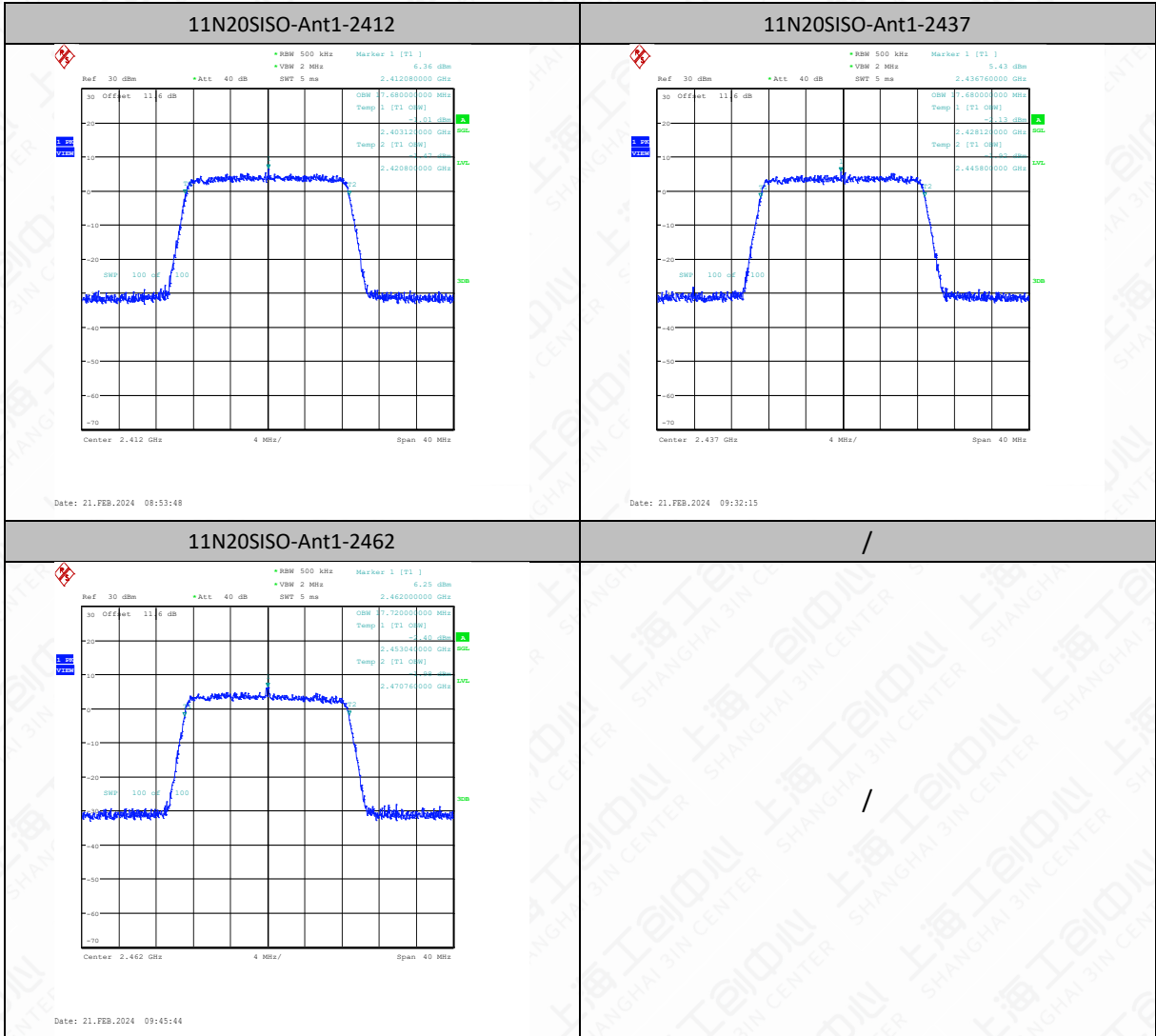

## 6.6 Band Edges Compliance

### 6.6.1 Measurement limit

Standard	Limit(dBc)
FCC 47 Part 15.247(d)	>30

### 6.6.2 Test procedures

The measurement is according to ANSI C63.10 clause 11.11.

The output power of EUT was connected to the spectrum analyzer. The path loss was compensated to the results for each measurement. Enable EUT transmitter maximum power continuously.

#### Reference level measurement

1. Set instrument center frequency to DTS channel center frequency.
2. Set the span to  $\geq 1.5$  times the DTS bandwidth.
3. Set the RBW = 100 kHz.
4. Set the VBW  $\geq [3 \times \text{RBW}]$ .
5. Detector = peak.
6. Sweep time = auto couple.
7. Trace mode = max hold.
8. Allow trace to fully stabilize.
9. Use the peak marker function to determine the maximum PSD level.

#### Emission level measurement

1. Set the center frequency and span to encompass frequency range to be measured.
2. Set the RBW = 100 kHz.
3. Set the VBW  $\geq [3 \times \text{RBW}]$ .
4. Detector = peak.
5. Sweep time = auto couple.
6. Trace mode = max hold.
7. Allow trace to fully stabilize.
8. Use the peak marker function to determine the maximum amplitude level.

## 6.6.3 Measurement results

TestMode	Antenna	ChName	Frequency[MHz]	RefLevel[dBm]	Result[dBm]	Limit[dBm]	Verdict
11B	Ant1	Low	2412	2.67	-43.17	≤-27.33	PASS
11B	Ant1	High	2462	2.07	-43.61	≤-27.93	PASS
11G	Ant1	Low	2412	-0.21	-42.11	≤-30.21	PASS
11G	Ant1	High	2462	0.46	-42.96	≤-29.54	PASS
11N20SISO	Ant1	Low	2412	0.47	-43.3	≤-29.53	PASS
11N20SISO	Ant1	High	2462	-0.21	-43.72	≤-30.21	PASS

## Test Graphs

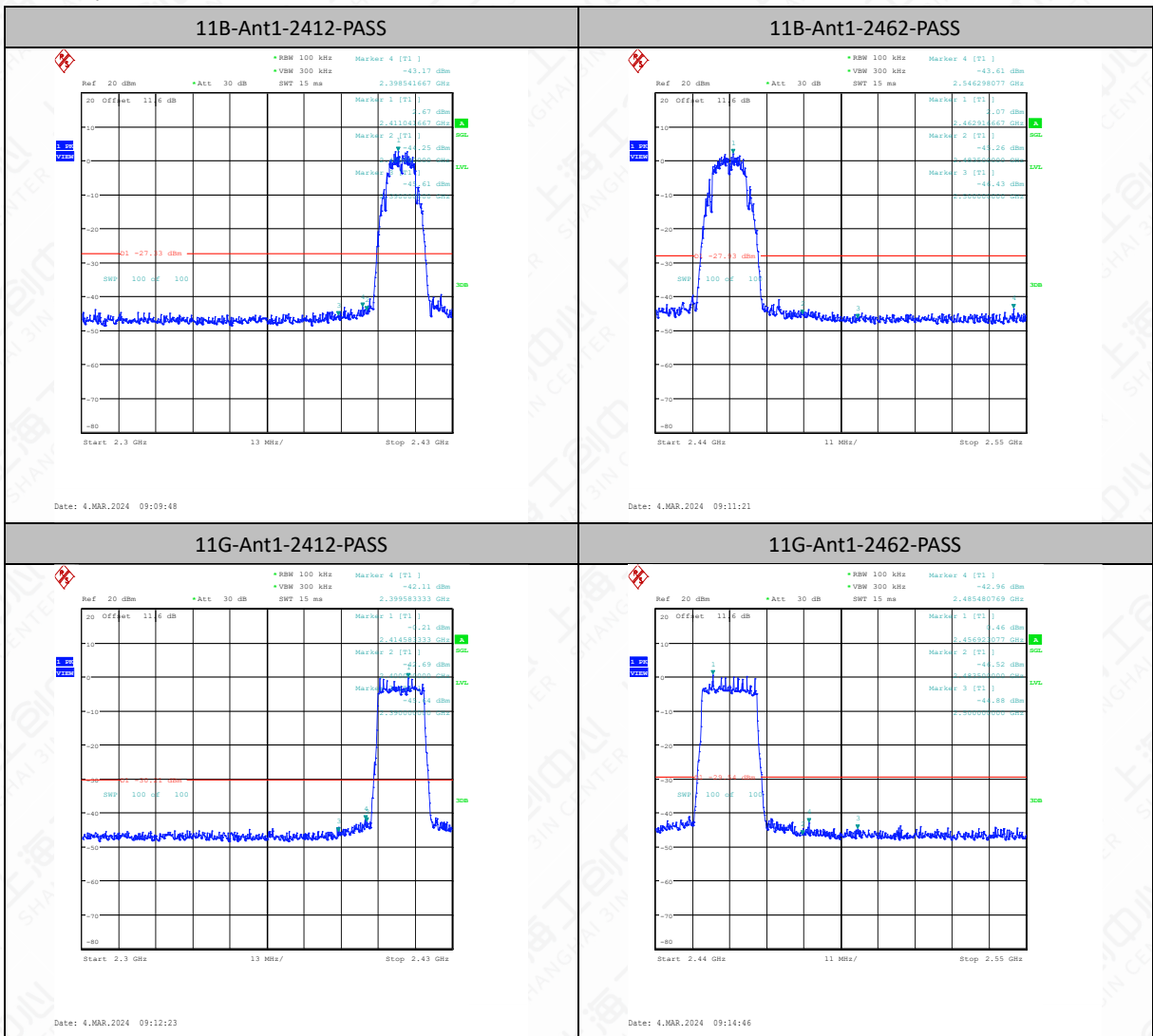



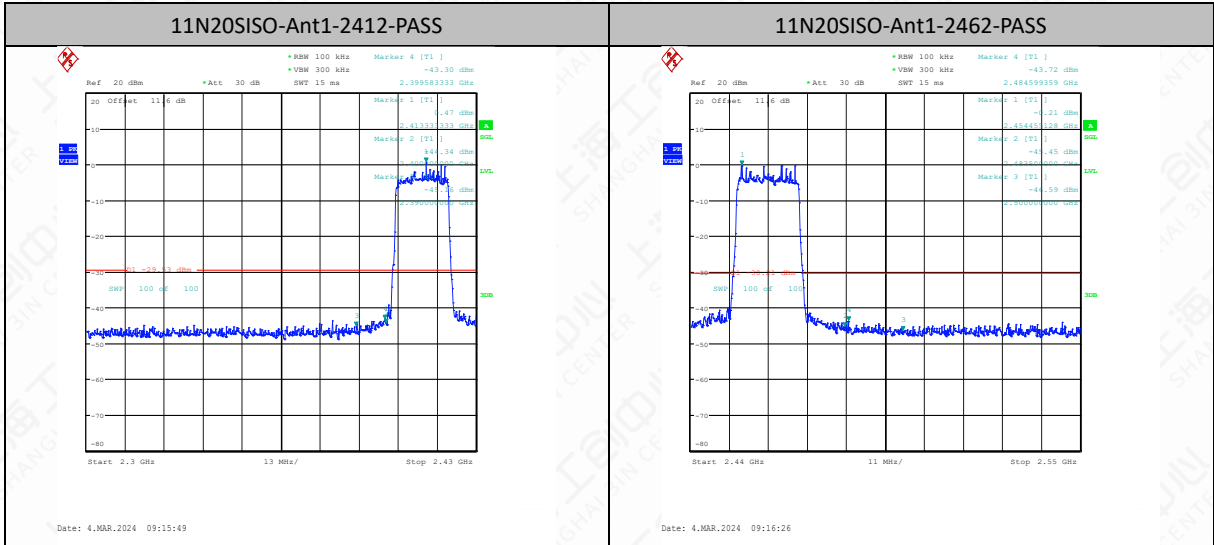

## 6.7 Transmitter Spurious Emission-conducted

### 6.7.1 Measurement Limit

Standard	Limit
FCC 47 Part 15.247(d)	30dB below highest level power in 100KHz bandwidth

### 6.7.2 Test procedures

This measurement is according to ANSI C63.10 clause 11.11.

The output power of EUT was connected to the spectrum analyzer. The path loss was compensated to the results for each measurement.

Enable EUT transmitter maximum power continuously.

#### Reference level measurement

1. Set instrument center frequency to DTS channel center frequency.
2. Set the span to  $\geq 1.5$  times the DTS bandwidth.
3. Set the RBW = 100 kHz.
4. Set the VBW  $\geq [3 \times \text{RBW}]$ .
5. Detector = peak.
6. Sweep time = auto couple.
7. Trace mode = max hold.
8. Allow trace to fully stabilize.
9. Use the peak marker function to determine the maximum PSD level.

#### Emission level measurement

1. Set the center frequency and span to encompass frequency range to be measured.
2. Set the RBW = 100 kHz.
3. Set the VBW  $\geq [3 \times \text{RBW}]$ .
4. Detector = peak.
5. Sweep time = auto couple.
6. Trace mode = max hold.
7. Allow trace to fully stabilize.
8. Use the peak marker function to determine the maximum amplitude level.



## 6.7.3 Test Setup

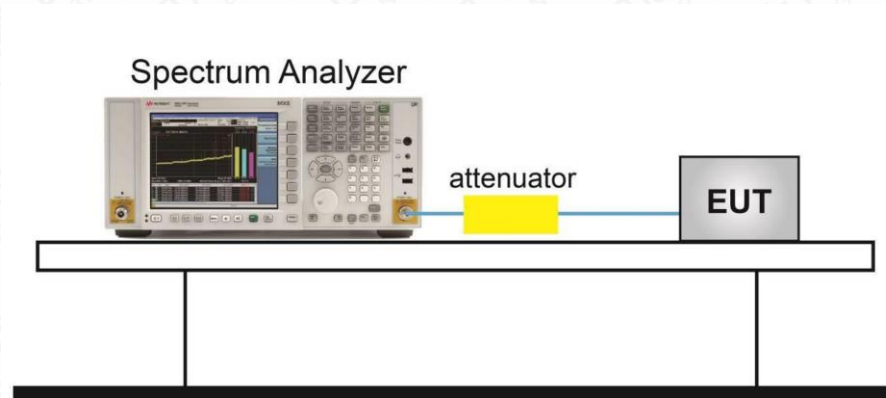

## 6.7.4 Measurement Result

TestMode	Antenna	Frequency[MHz]	FreqRange [Mhz]	RefLevel [dBm]	Result [dBm]	Limit [dBm]	Verdict
11B	Ant1	2412	0~Reference	1.11	1.11	---	PASS
11B	Ant1	2412	30~1000	1.11	-48.81	≤-28.89	PASS
11B	Ant1	2412	1000~26500	1.11	-50.16	≤-28.89	PASS
11B	Ant1	2437	0~Reference	1.89	1.89	---	PASS
11B	Ant1	2437	30~1000	1.89	-47.25	≤-28.11	PASS
11B	Ant1	2437	1000~26500	1.89	-51.07	≤-28.11	PASS
11B	Ant1	2462	0~Reference	0.87	0.87	---	PASS
11B	Ant1	2462	30~1000	0.87	-47.26	≤-29.13	PASS
11B	Ant1	2462	1000~26500	0.87	-50.33	≤-29.13	PASS
11G	Ant1	2412	0~Reference	-0.14	-0.14	---	PASS
11G	Ant1	2412	30~1000	-0.14	-54.62	≤-30.14	PASS
11G	Ant1	2412	1000~26500	-0.14	-50.49	≤-30.14	PASS
11G	Ant1	2437	0~Reference	-0.04	-0.04	---	PASS
11G	Ant1	2437	30~1000	-0.04	-54.6	≤-30.04	PASS
11G	Ant1	2437	1000~26500	-0.04	-51.3	≤-30.04	PASS
11G	Ant1	2462	0~Reference	-1.05	-1.05	---	PASS
11G	Ant1	2462	30~1000	-1.05	-55.04	≤-31.05	PASS
11G	Ant1	2462	1000~26500	-1.05	-50.56	≤-31.05	PASS
11N20SISO	Ant1	2412	0~Reference	-0.53	-0.53	---	PASS
11N20SISO	Ant1	2412	30~1000	-0.53	-55.2	≤-30.53	PASS
11N20SISO	Ant1	2412	1000~26500	-0.53	-44	≤-30.53	PASS
11N20SISO	Ant1	2437	0~Reference	-0.26	-0.26	---	PASS
11N20SISO	Ant1	2437	30~1000	-0.26	-54.97	≤-30.26	PASS
11N20SISO	Ant1	2437	1000~26500	-0.26	-50.98	≤-30.26	PASS
11N20SISO	Ant1	2462	0~Reference	0.16	0.16	---	PASS
11N20SISO	Ant1	2462	30~1000	0.16	-54.56	≤-29.84	PASS
11N20SISO	Ant1	2462	1000~26500	0.16	-51.34	≤-29.84	PASS



## Test Graphs

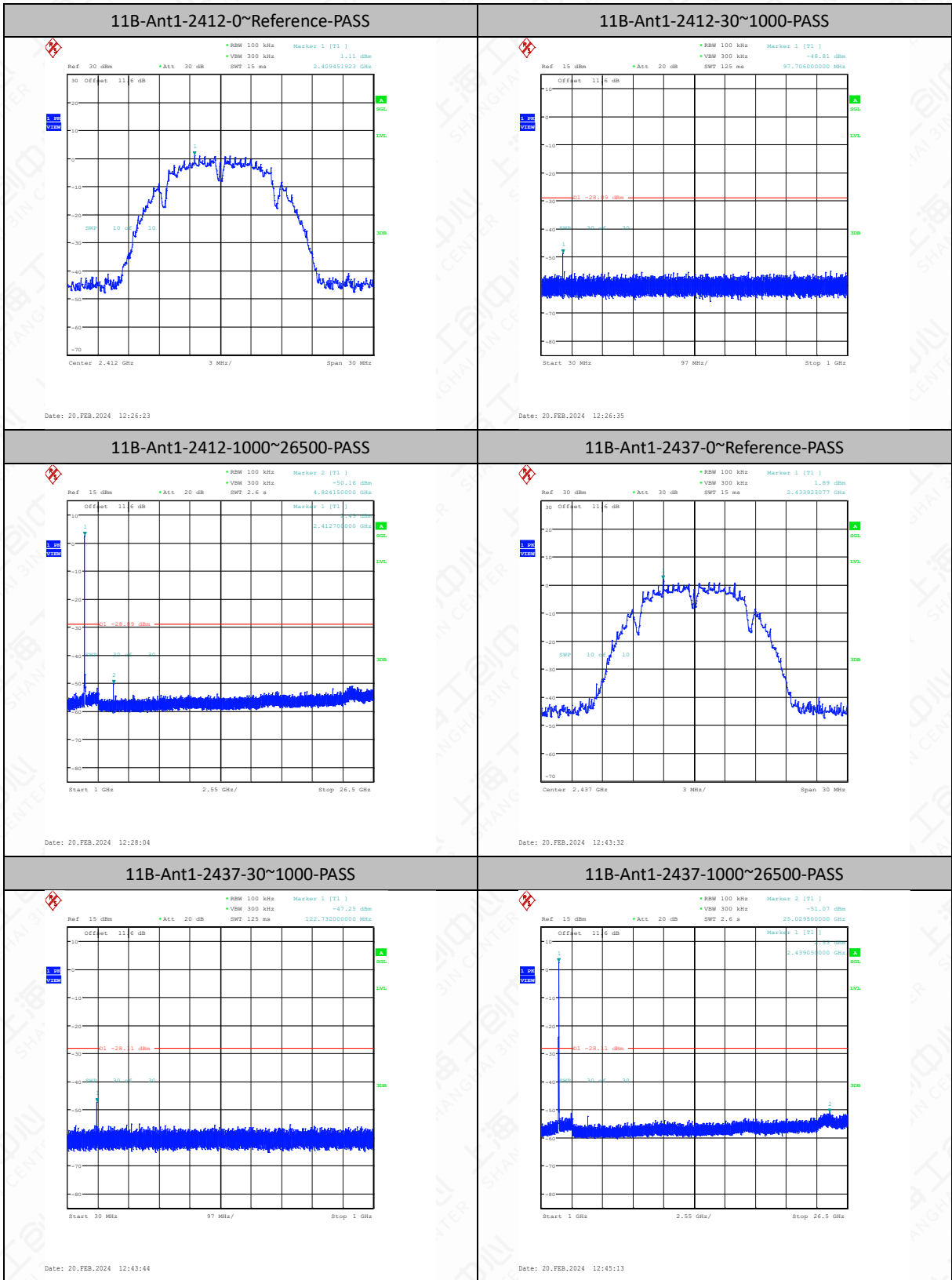

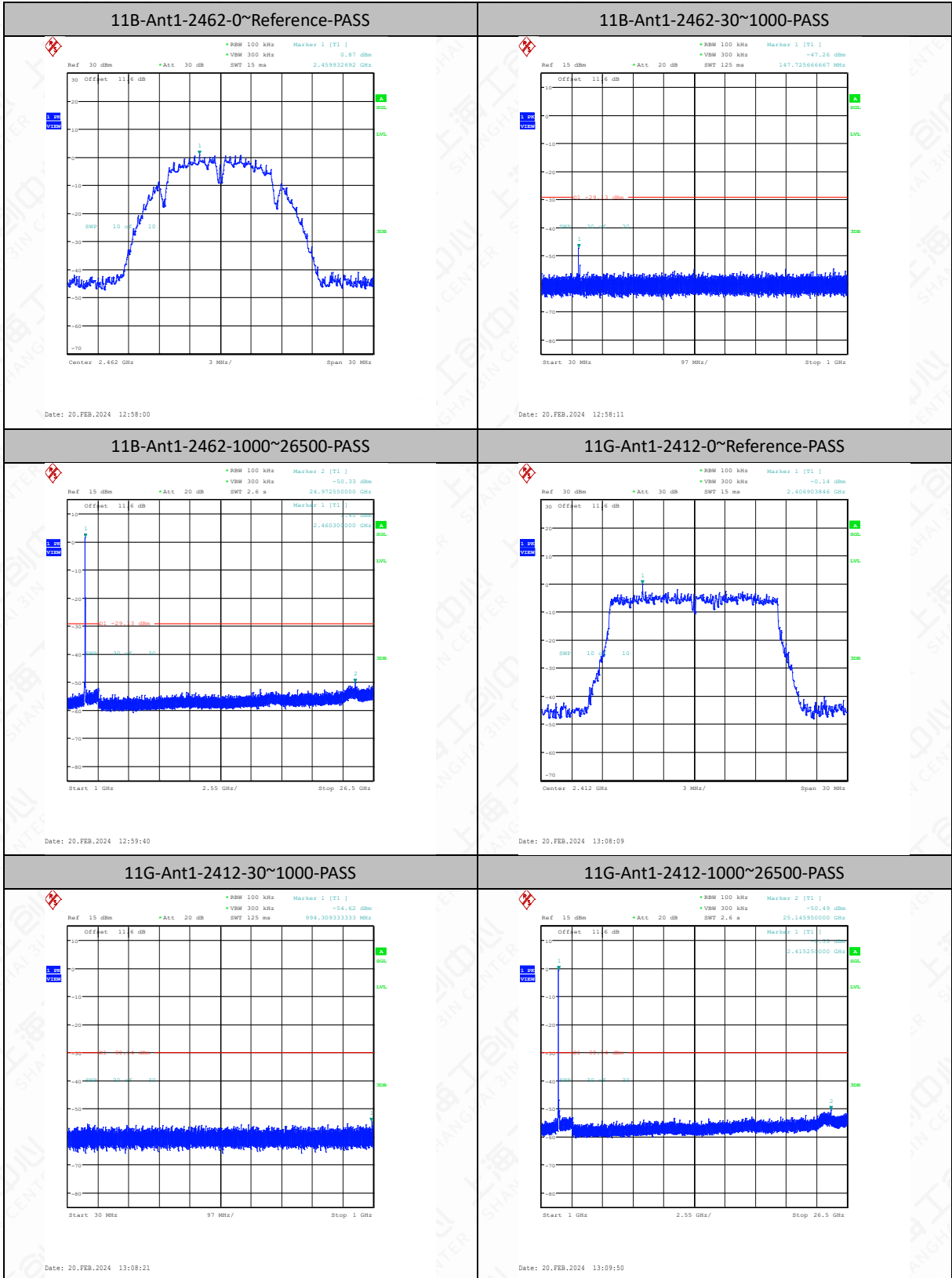

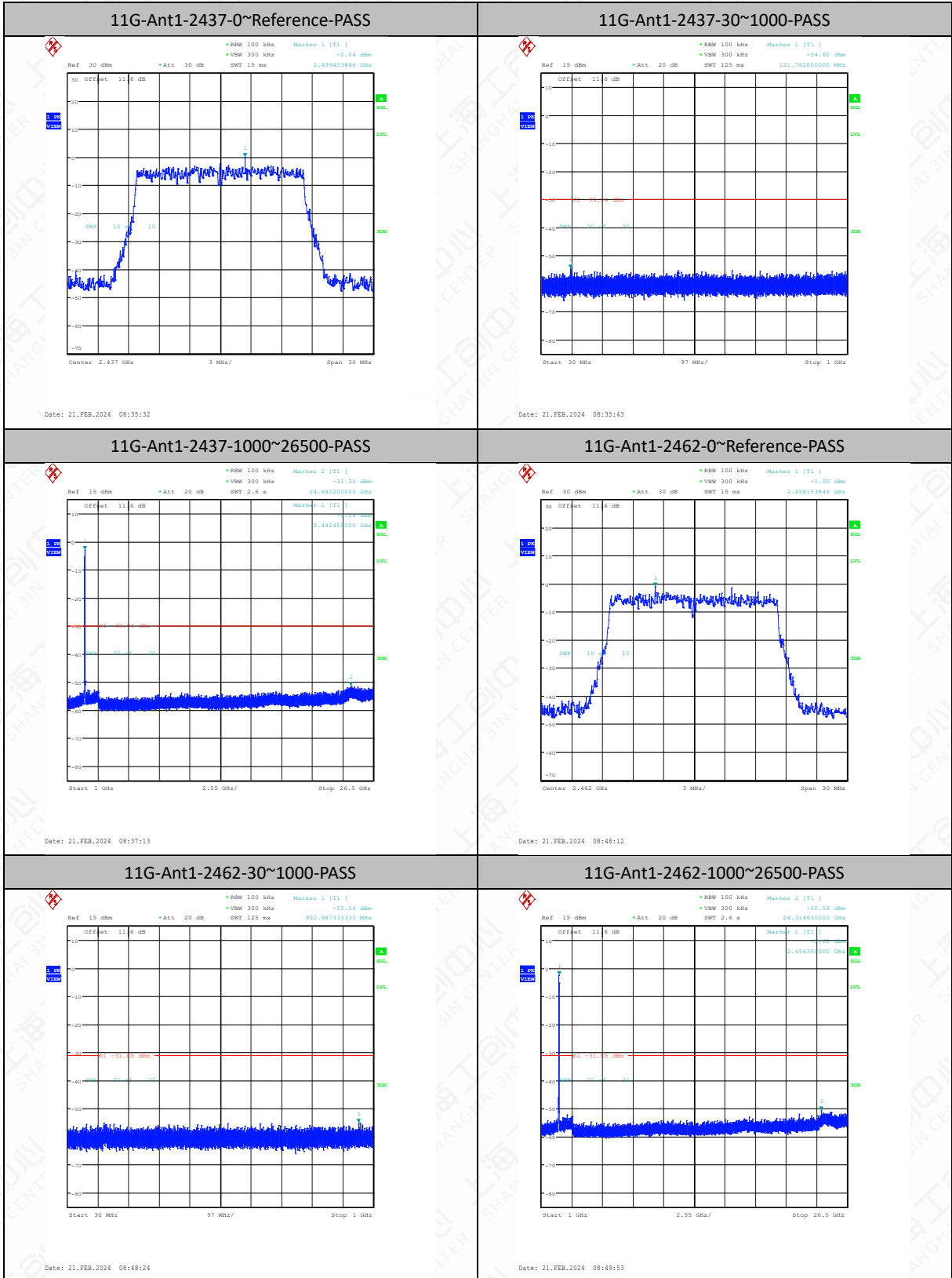



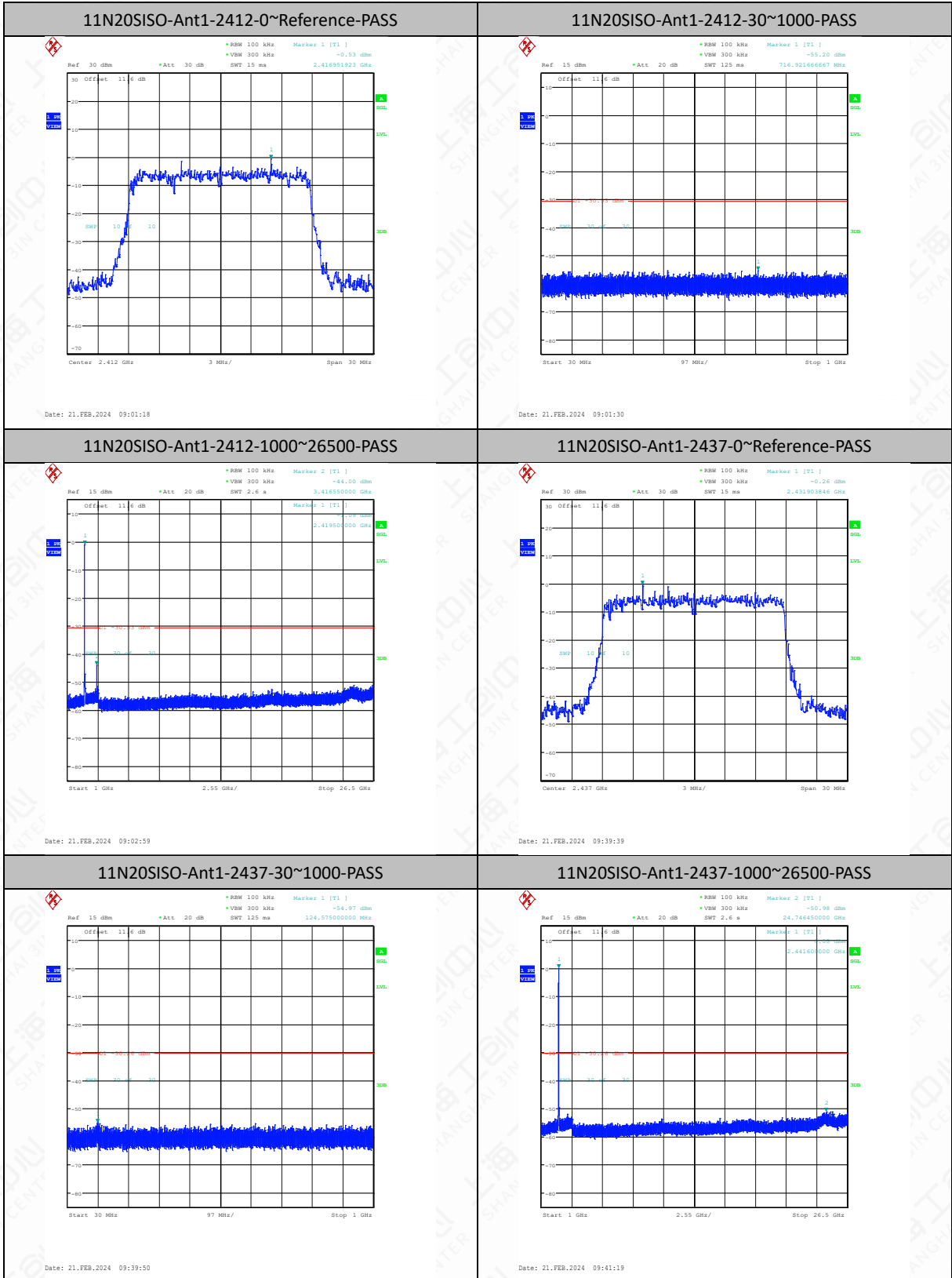

11N20SISO-Ant1-2462-0~Reference-PASS	11N20SISO-Ant1-2462-30~1000-PASS
11N20SISO-Ant1-2462-1000~26500-PASS	/
	<p style="text-align: center;">/</p>

## 6.8 Transmitter Spurious Emission-Radiated

### 6.8.1 Measurement Limit

Standard	Limit
FCC 47 Part 15.247,15.205,15.209	20dB below peak output power

In addition, radiated emissions which fall in the restricted bands, as defined in 25.205(a), must also comply with the radiated emission limits specified in 15.209(a)(see 15.205(c)).

The measurement is according to ANSI C63.10 clause 11.11 and 11.12.

### 6.8.2 Limit in restricted band

Frequency of emission (MHz)	Field strength(uV/m)	Field strength(dBuV/m)
0.009~0.49	2400/F (kHz)	129-94
0.49~1.705	24000/F (kHz)	74-63
1.705~30	30	70
30~88	100	40
88~216	150	43.5
216~960	200	46
Above 960	500	54

### 6.8.3 Test procedures

The measurement is according to ANSI C63.10 clause 11.11 and 11.12.

Portable, small, lightweight, or modular devices that may be handheld, worn on the body, or placed on a table during operation shall be positioned on a non-conducting platform, the top of which is 80 cm above the reference ground plane. The preferred area occupied by the EUT arrangement is 1 m by 1.5 m, For emissions testing at or below 1 GHz, the table height shall be 80 cm above the reference ground plane. For emission measurements above 1 GHz, the table height shall be 1.5 m. but it may be larger or smaller to accommodate various sized EUTs. For testing purposes, ceiling- and wall-mounted devices also shall be positioned on a tabletop (see also ANSI C63.10-2013 section 6.3.4 and 6.3.5). In making any tests involving handheld, body-worn, or ceiling-mounted equipment, it is essential to recognize that the measured levels may be dependent on the orientation (attitude) of the three orthogonal axes of the EUT. Thus, exploratory tests as specified in 8.3.1 shall be carried out for various axes orientations to determine the attitude having maximum or near-maximum emission level.

The EUT was placed on a non-conductive table. The measurement antenna was placed at a distance of 3 meters from the EUT. During the tests, the antenna height varied from 1m to 4m and the EUT azimuth were varied from 0° to 360° in order to identify the maximum level of emissions from the EUT. This maximization process was repeated with the EUT positioned in each of its three orthogonal orientations.

#### Test Settings – Below 1GHz (Quasi-Peak Field Strength Measurements)

1. Set the center frequency and span to encompass frequency range to be measured.
2. Set the RBW = 100 kHz.
3. Set the VBW = 300 kHz.
4. Detector = quasi-peak.
5. Sweep time = auto couple.



6. Trace mode = max hold.
7. Trace was allowed to stabilize.

**Test Settings – Above 1GHz (Peak Field Strength Measurements)**

1. Set the center frequency and span to encompass frequency range to be measured.
2. Set the RBW = 1MHz.
3. Set the VBW = 3MHz.
4. Detector = peak
5. Trace mode = max hold
6. Sweep time = auto
7. Trace (RMS) averaging was performed over at least 100 traces.

**Test Settings – Above 1GHz (Average Field Strength Measurements)**

1. Set the center frequency and span to encompass frequency range to be measured.
2. Set the RBW = 1MHz.
3. Set the VBW = 3MHz.
4. Detector = power average (RMS).
5. Number of measurement points = 1001 (Number of points must be  $\geq 2 \times \text{span} \backslash \backslash \text{RBW}$ )
6. Sweep time = auto
7. Trace (RMS) averaging was performed over at least 100 traces.

Frequency of emission	RBW/VBW	Sweep Time (s)
0.009~30	9KHz/30KHz	Auto
30~1000	100KHz/300KHz	5
1000~4000	1MHz/3MHz	15
4000~18000	1MHz/3MHz	40
18000~26500	1MHz/3MHz	20

6.8.4 Test Setup

Below 30MHz Test Setup

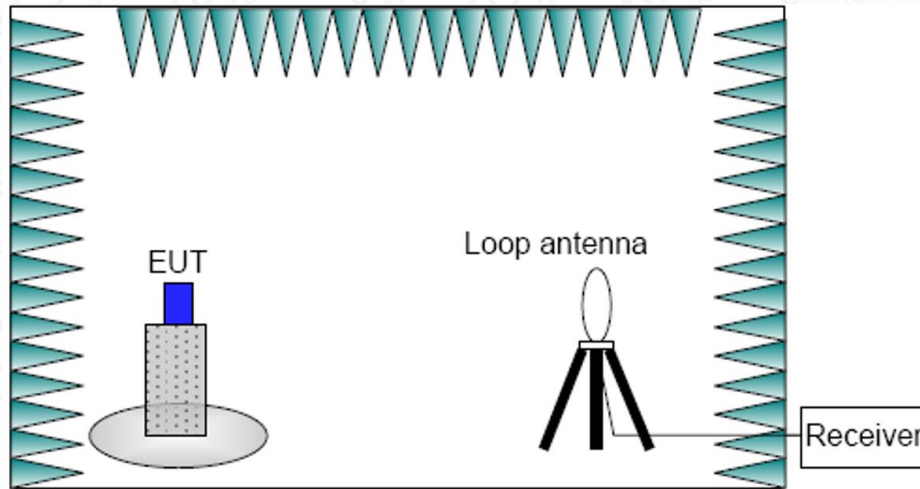

Below 1GHz Test Setup

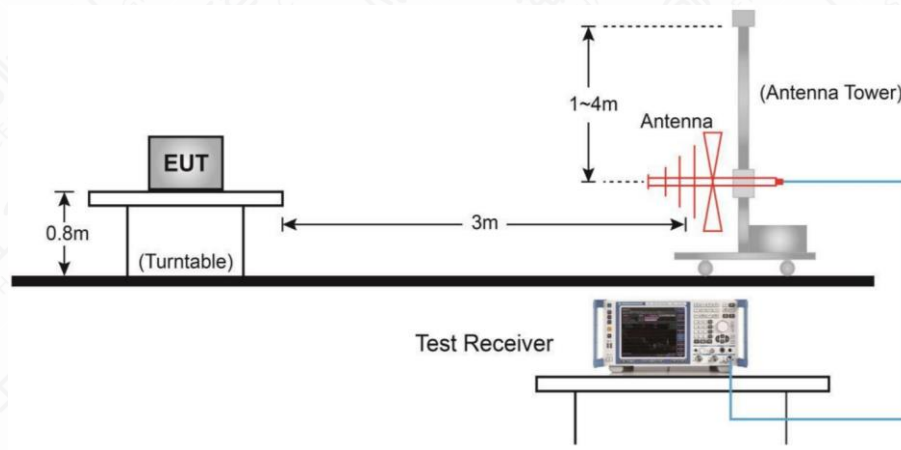

Above 1GHz Test Setup

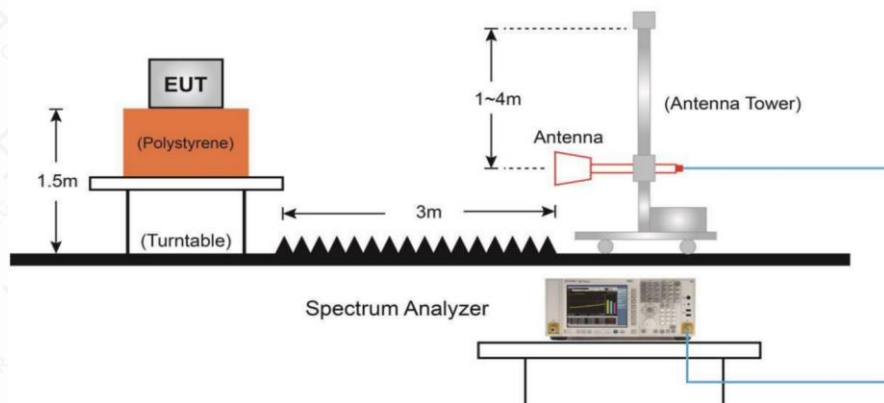

### 6.8.5 Measurement Results

A "reference path loss" is established and  $A_{Rpi}$  is the attenuation of "reference path loss", and including the gain of receive antenna, the gain of the preamplifier, the cable loss.

$P_{Mea}$  is the field strength recorded from the instrument.

The measurement results are obtained as described below:

$A_{Rpi}$  = Cable loss + Antenna Factor-Preamplifier gain

Result =  $P_{Mea}$  + Cable loss + Antenna Factor-Preamplifier gain =  $P_{Mea}$  +  $A_{Rpi}$ .

#### Internal antenna

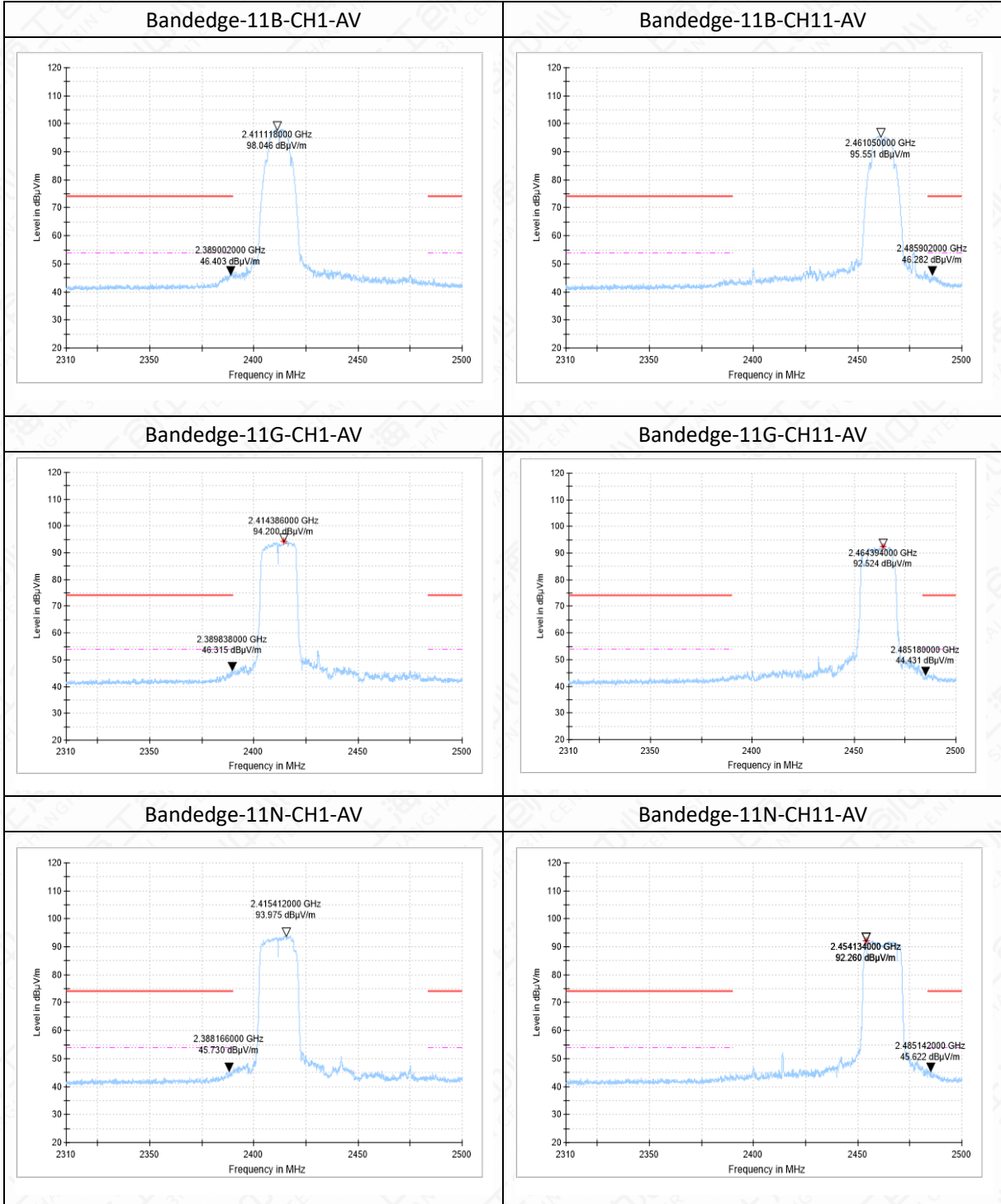



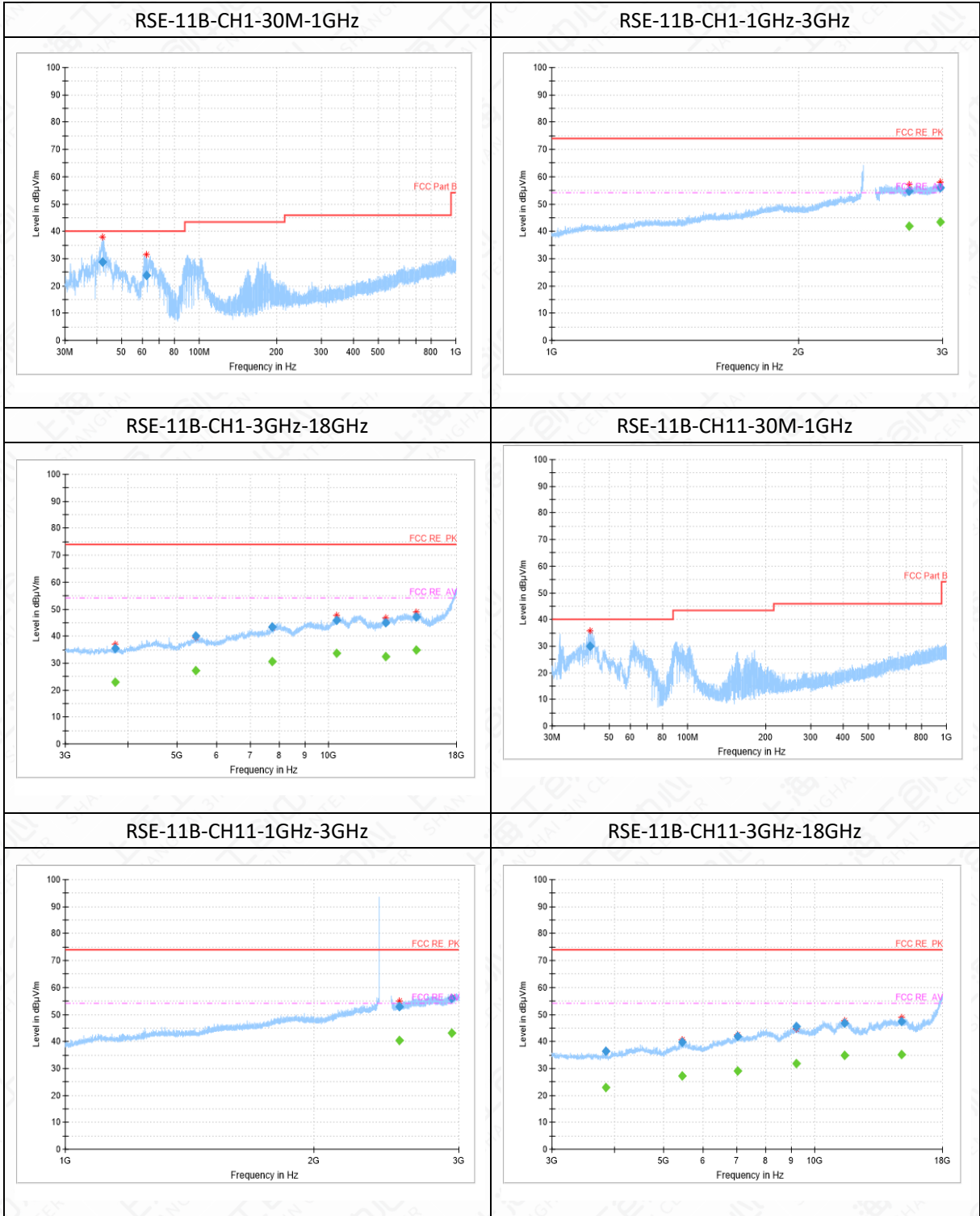

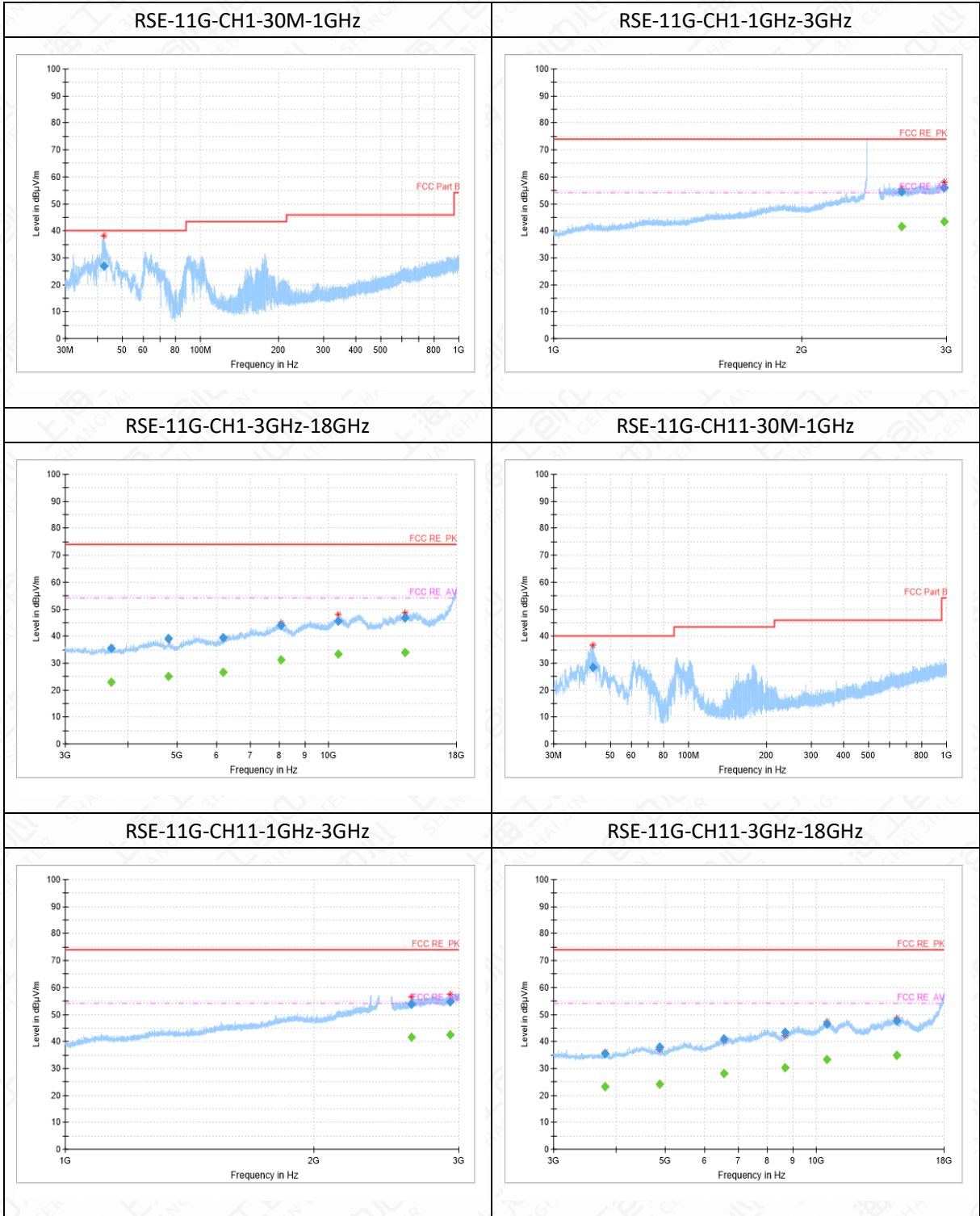

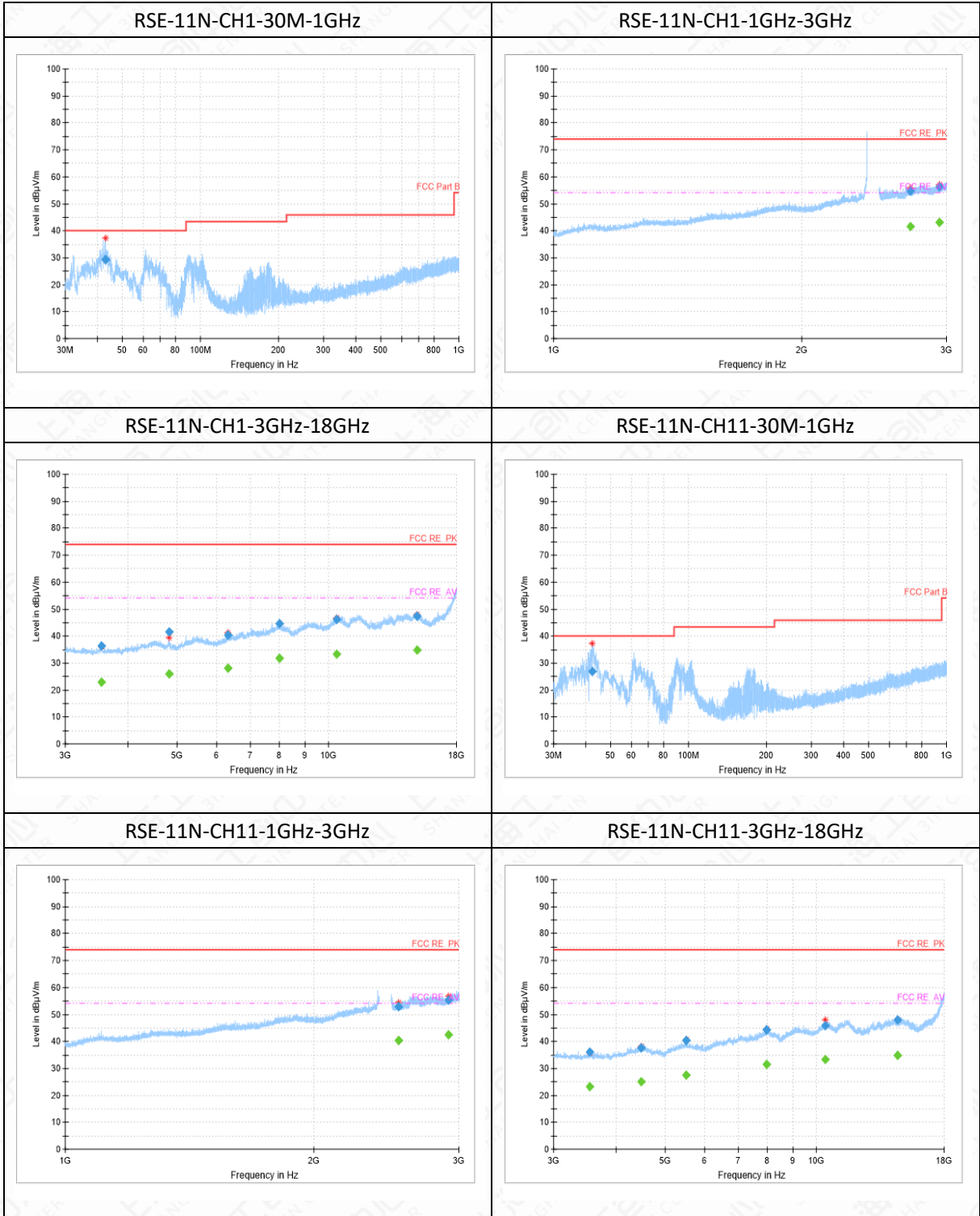



External antenna

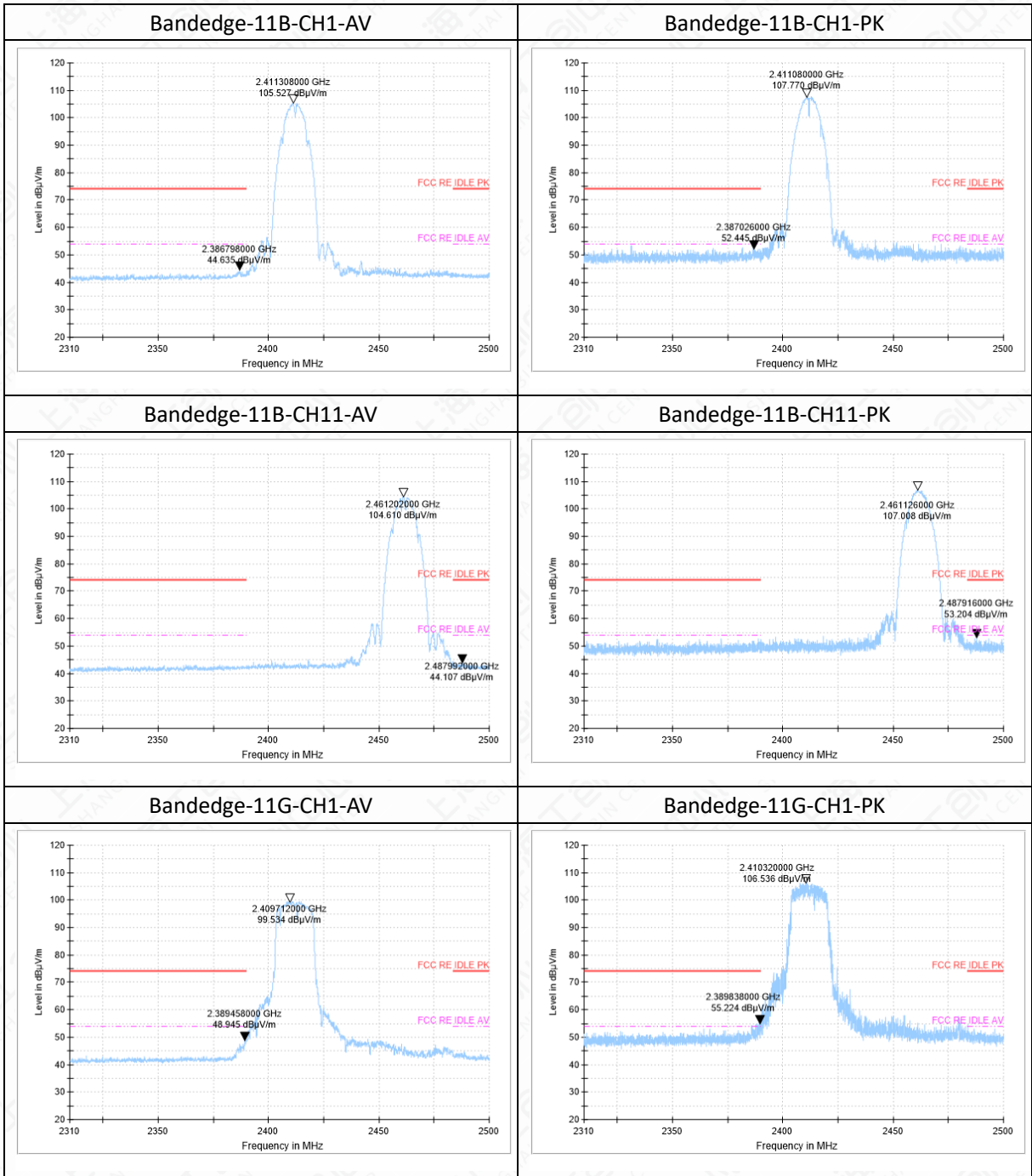

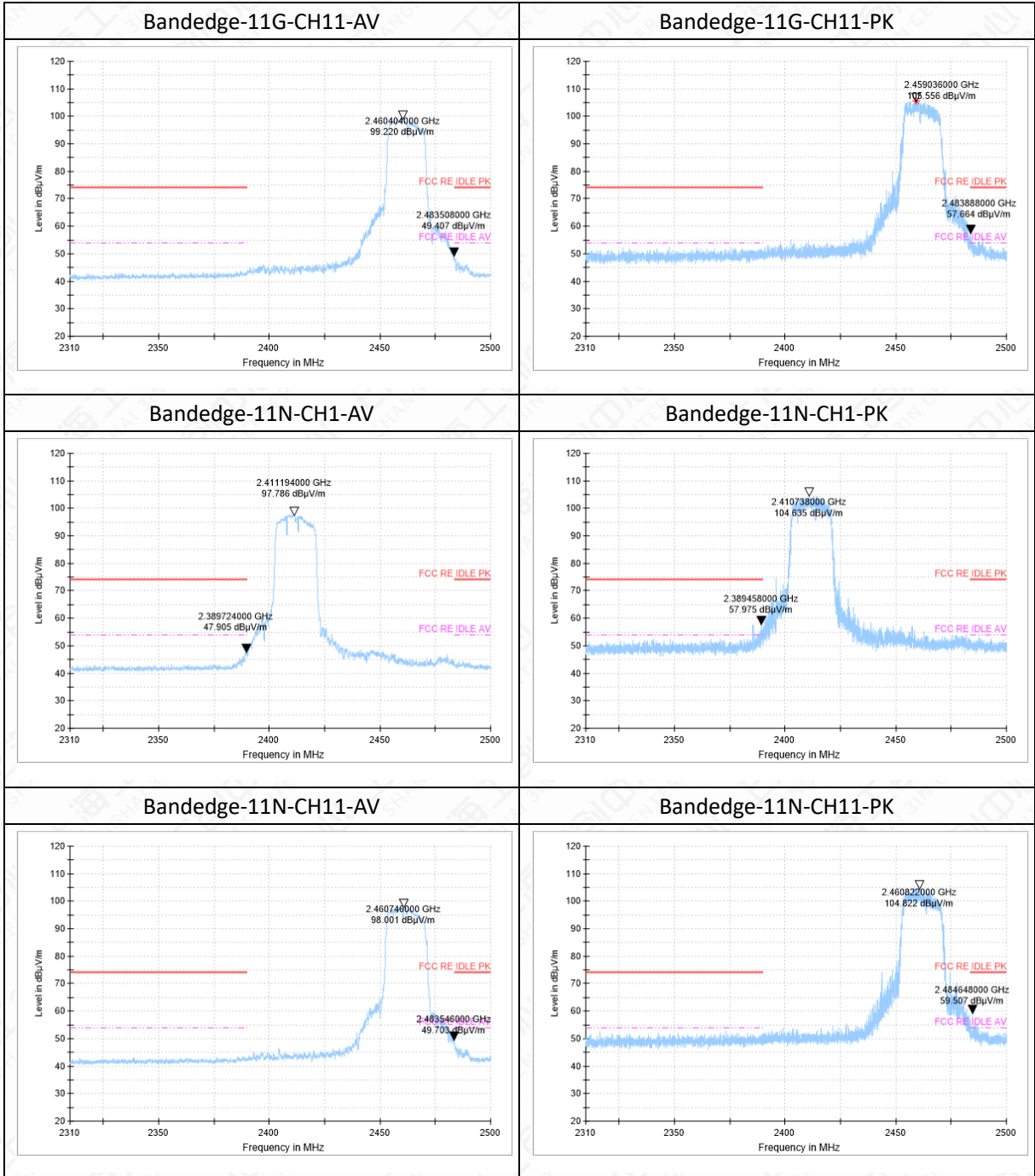

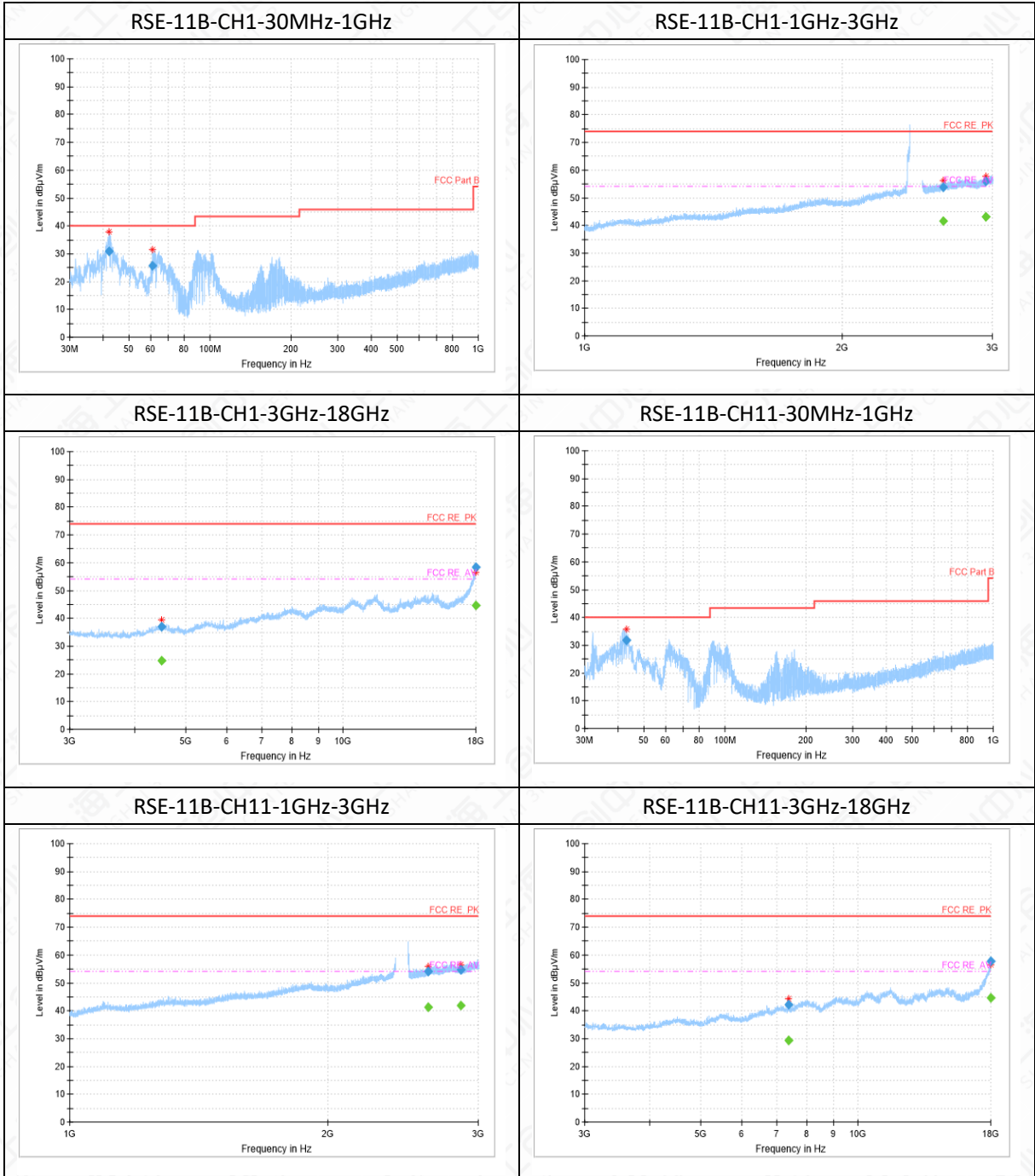



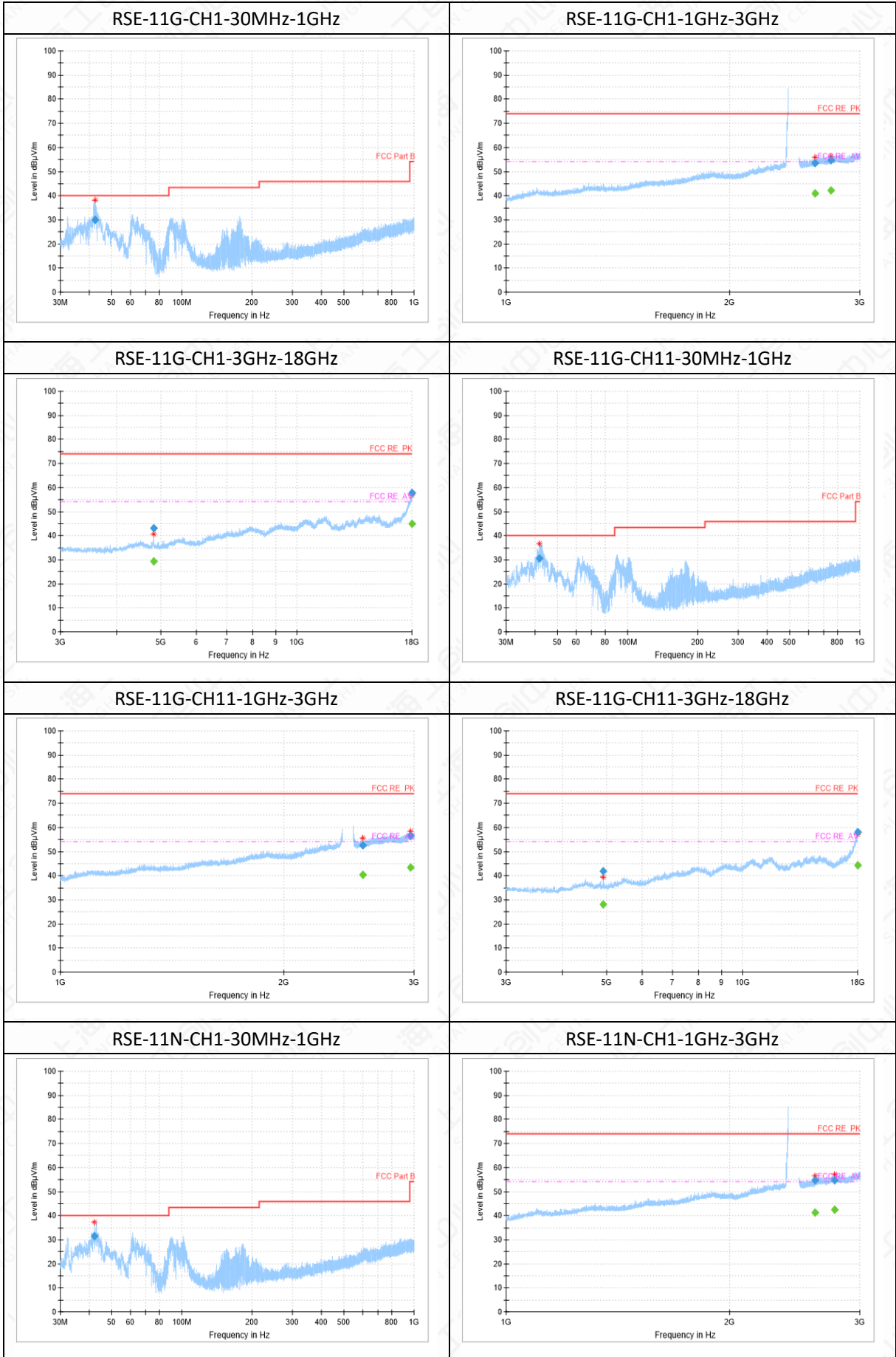

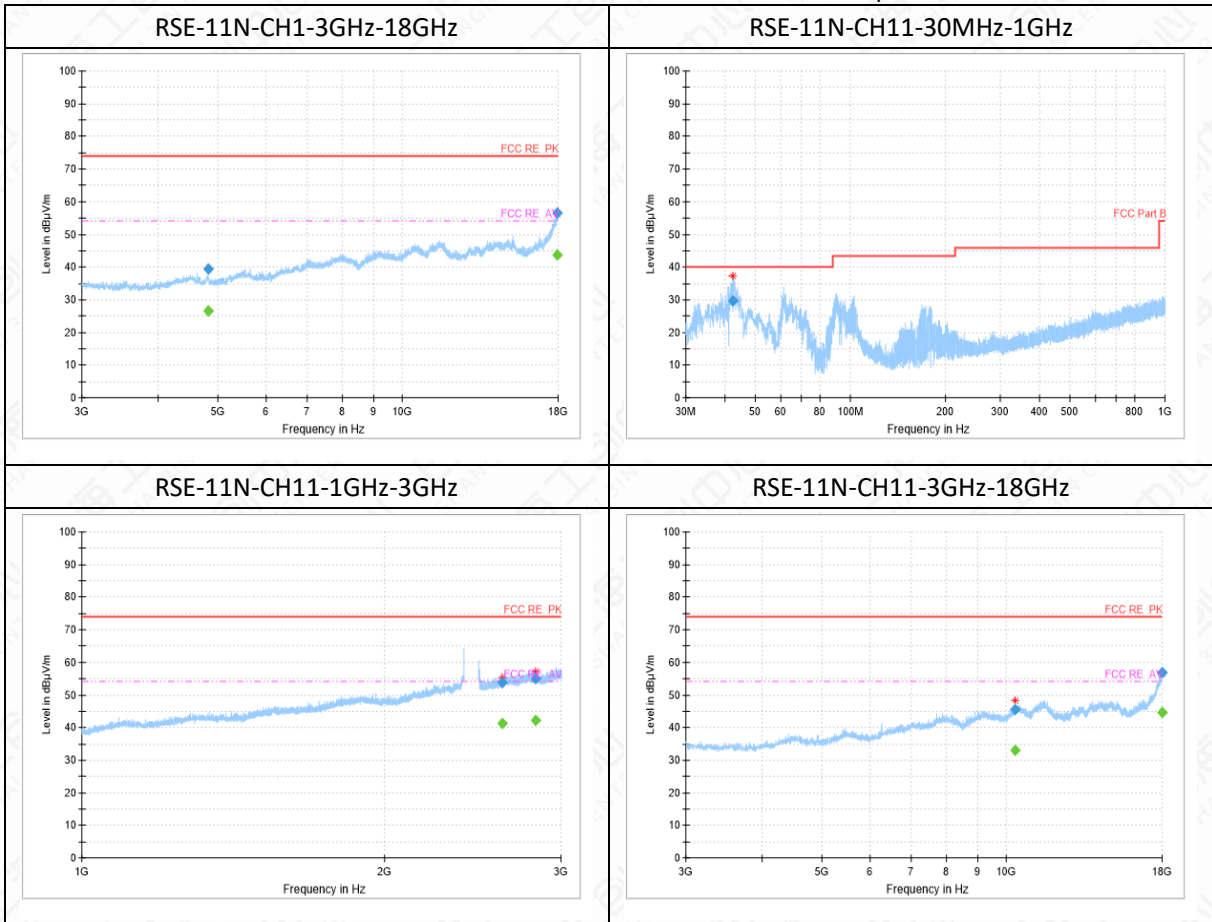

Note:1. The out-of-limit signal in the picture is the main frequency signal.

2. Only data in worst mode is provided.

3. Sweep the whole frequency band through the range from 30MHz to the 10th harmonic of the carrier, the Emissions in the frequency band 18GHz-26.5GHz is more than 20dB below the limit are not report.

4. The test data below 30MHz is more than 20dB lower than the limit value, so it is not provided in the report.

5. Horizontal and vertical polarity is all have been tested, the result of them is synthesized in the above data diagram.

**Internal antenna**
**RSE-11B-CH1-30M-1GHz**

Frequency (MHz)	QuasiPeak(dBμV/m)	ARpl (dB)	PMea (dBμV/m)	Margin(dB)	Limit(dBμV/m)	Polarity
42.1	28.77	-13	41.77	11.23	40.00	V
62.3	23.82	-13	36.82	16.18	40.00	V

**RSE-11B-CH1-1GHz-3GHz**

Frequency (MHz)	MaxPeak(dBμV/m)	ARpl (dB)	PMea (dBμV/m)	Margin(dB)	Limit(dBμV/m)	Polarity
2731.0	54.62	18	36.62	19.38	74.00	V
2978.0	56.08	19	37.08	17.92	74.00	V

**RSE-11B-CH1-1GHz-3GHz**

Frequency (MHz)	Average(dBμV/m)	ARpl (dB)	PMea (dBμV/m)	Margin(dB)	Limit(dBμV/m)	Polarity
2731.0	41.91	18	23.91	12.09	54.00	V
2978.0	43.48	19	24.48	10.52	54.00	V

**RSE-11B-CH1-3GHz-18GHz**

Frequency (MHz)	MaxPeak(dBμV/m)	ARpl (dB)	PMea (dBμV/m)	Margin(dB)	Limit(dBμV/m)	Polarity
3773.4	35.38	-10	45.38	38.62	74.00	V
5455.4	40.03	-6	46.03	33.97	74.00	H
7725.0	43.32	-1	44.32	30.68	74.00	H
10383.2	45.78	3	42.78	28.22	74.00	H
13001.8	44.97	4	40.97	29.03	74.00	V
14955.9	47.22	7	40.22	26.78	74.00	V

**RSE-11B-CH1-3GHz-18GHz**

Frequency (MHz)	Average(dBμV/m)	ARpl (dB)	PMea (dBμV/m)	Margin(dB)	Limit(dBμV/m)	Polarity
3773.4	23	-10	33	31.00	54.00	V
5455.4	27.18	-6	33.18	26.82	54.00	H
7725.0	30.7	-1	31.7	23.30	54.00	H
10383.2	33.61	3	30.61	20.39	54.00	H
13001.8	32.42	4	28.42	21.58	54.00	V
14955.9	34.92	7	27.92	19.08	54.00	V

**RSE-11B-CH11-30M-1GHz**



Frequency (MHz)	QuasiPeak(dBμV/m)	ARpl (dB)	PMea (dBμV/m)	Margin(dB)	Limit(dBμV/m)	Polarity
41.9	29.92	-13	42.92	10.08	40.00	V

**RSE-11B-CH11-1GHz-3GHz**

Frequency (MHz)	MaxPeak(dBμV/m)	ARpl (dB)	PMea (dBμV/m)	Margin(dB)	Limit(dBμV/m)	Polarity
2542.8	53.04	16	37.04	20.96	74.00	H
2942.2	55.95	19	36.95	18.05	74.00	V

**RSE-11B-CH11-1GHz-3GHz**

Frequency (MHz)	Average(dBμV/m)	ARpl (dB)	PMea (dBμV/m)	Margin(dB)	Limit(dBμV/m)	Polarity
2542.8	40.43	16	24.43	13.57	54.00	H
2942.2	43.16	19	24.16	10.84	54.00	V

**RSE-11B-CH11-3GHz-18GHz**

Frequency (MHz)	MaxPeak(dBμV/m)	ARpl (dB)	PMea (dBμV/m)	Margin(dB)	Limit(dBμV/m)	Polarity
3845.6	36.37	-10	46.37	37.63	74.00	H
5461.0	39.88	-6	45.88	34.12	74.00	H
7026.5	41.84	-2	43.84	32.16	74.00	V
9197.4	45.5	1	44.5	28.50	74.00	V
11498.5	46.81	5	41.81	27.19	74.00	H
14912.8	47.55	8	39.55	26.45	74.00	V

**RSE-11B-CH11-3GHz-18GHz**

Frequency (MHz)	Average(dBμV/m)	ARpl (dB)	PMea (dBμV/m)	Margin(dB)	Limit(dBμV/m)	Polarity
3845.6	23.01	-10	33.01	30.99	54.00	H
5461.0	27.24	-6	33.24	26.76	54.00	H
7026.5	29.1	-2	31.1	24.90	54.00	V
9197.4	31.87	1	30.87	22.13	54.00	V
11498.5	34.74	5	29.74	19.26	54.00	H
14912.8	35.03	8	27.03	18.97	54.00	V

**RSE-11G-CH1-30M-1GHz**

Frequency (MHz)	QuasiPeak(dBμV/m)	ARpl (dB)	PMea (dBμV/m)	Margin(dB)	Limit(dBμV/m)	Polarity
42.3	26.83	-13	39.83	13.17	40.00	V

## RSE-11G-CH1-1GHz-3GHz

Frequency (MHz)	MaxPeak(dBμV/m)	ARpl (dB)	PMea (dBμV/m)	Margin(dB)	Limit(dBμV/m)	Polarity
2644.1	54.51	17	37.51	19.49	74.00	H
2979.1	55.87	19	36.87	18.13	74.00	V

## RSE-11G-CH1-1GHz-3GHz

Frequency (MHz)	Average(dBμV/m)	ARpl (dB)	PMea (dBμV/m)	Margin(dB)	Limit(dBμV/m)	Polarity
2644.1	41.74	17	24.74	12.26	54.00	H
2979.1	43.52	19	24.52	10.48	54.00	V

## RSE-11G-CH1-3GHz-18GHz

Frequency (MHz)	MaxPeak(dBμV/m)	ARpl (dB)	PMea (dBμV/m)	Margin(dB)	Limit(dBμV/m)	Polarity
3705.9	35.6	-10	45.6	38.40	74.00	V
4811.8	39.02	-7	46.02	34.98	74.00	H
6188.5	39.51	-5	44.51	34.49	74.00	V
8056.4	44.04	0	44.04	29.96	74.00	V
10467.2	45.55	4	41.55	28.45	74.00	V
14222.4	46.82	7	39.82	27.18	74.00	H

## RSE-11G-CH1-3GHz-18GHz

Frequency (MHz)	Average(dBμV/m)	ARpl (dB)	PMea (dBμV/m)	Margin(dB)	Limit(dBμV/m)	Polarity
3705.9	23.05	-10	33.05	30.95	54.00	V
4811.8	25.2	-7	32.2	28.80	54.00	H
6188.5	26.47	-5	31.47	27.53	54.00	V
8056.4	31.18	0	31.18	22.82	54.00	V
10467.2	33.27	4	29.27	20.73	54.00	V
14222.4	33.99	7	26.99	20.01	54.00	H

## RSE-11G-CH11-30M-1GHz

Frequency (MHz)	QuasiPeak(dBμV/m)	ARpl (dB)	PMea (dBμV/m)	Margin(dB)	Limit(dBμV/m)	Polarity
42.5	28.55	-13	41.55	11.45	40.00	V

## RSE-11G-CH11-1GHz-3GHz

Frequency (MHz)	MaxPeak(dBμV/m)	ARpl (dB)	PMea (dBμV/m)	Margin(dB)	Limit(dBμV/m)	Polarity
-----------------	-----------------	-----------	---------------	------------	---------------	----------



2630.0	53.8	17	36.8	20.20	74.00	H
2923.7	54.83	18	36.83	19.17	74.00	V

## RSE-11G-CH11-1GHz-3GHz

Frequency (MHz)	Average(dBμV/m)	ARpl (dB)	PMea (dBμV/m)	Margin(dB)	Limit(dBμV/m)	Polarity
2630.0	41.62	17	24.62	12.38	54.00	H
2923.7	42.5	18	24.5	11.50	54.00	V

## RSE-11G-CH11-3GHz-18GHz

Frequency (MHz)	MaxPeak(dBμV/m)	ARpl (dB)	PMea (dBμV/m)	Margin(dB)	Limit(dBμV/m)	Polarity
3799.2	35.47	-10	45.47	38.53	74.00	V
4885.2	38.04	-6	44.04	35.96	74.00	V
6548.0	40.88	-4	44.88	33.12	74.00	V
8678.4	43.27	-1	44.27	30.73	74.00	H
10505.1	46.58	4	42.58	27.42	74.00	H
14470.2	47.56	7	40.56	26.44	74.00	V

## RSE-11G-CH11-3GHz-18GHz

Frequency (MHz)	Average(dBμV/m)	ARpl (dB)	PMea (dBμV/m)	Margin(dB)	Limit(dBμV/m)	Polarity
3799.2	23.11	-10	33.11	30.89	54.00	V
4885.2	24.28	-6	30.28	29.72	54.00	V
6548.0	28.25	-4	32.25	25.75	54.00	V
8678.4	30.4	-1	31.4	23.60	54.00	H
10505.1	33.47	4	29.47	20.53	54.00	H
14470.2	34.91	7	27.91	19.09	54.00	V

## RSE-11N-CH1-30M-1GHz

Frequency (MHz)	QuasiPeak(dBμV/m)	ARpl (dB)	PMea (dBμV/m)	Margin(dB)	Limit(dBμV/m)	Polarity
42.9	29.5	-13	42.5	10.50	40.00	V

## RSE-11N-CH1-1GHz-3GHz

Frequency (MHz)	MaxPeak(dBμV/m)	ARpl (dB)	PMea (dBμV/m)	Margin(dB)	Limit(dBμV/m)	Polarity
2711.4	54.64	17	37.64	19.36	74.00	V
2940.2	56.19	19	37.19	17.81	74.00	V



## RSE-11N-CH1-1GHz-3GHz

Frequency (MHz)	Average(dBμV/m)	ARpl (dB)	PMea (dBμV/m)	Margin(dB)	Limit(dBμV/m)	Polarity
2711.4	41.68	17	24.68	12.32	54.00	V
2940.2	43.07	19	24.07	10.93	54.00	V

## RSE-11N-CH1-3GHz-18GHz

Frequency (MHz)	MaxPeak(dBμV/m)	ARpl (dB)	PMea (dBμV/m)	Margin(dB)	Limit(dBμV/m)	Polarity
3543.8	36.4	-10	46.4	37.60	74.00	H
4827.6	41.51	-7	48.51	32.49	74.00	H
6322.0	40.25	-4	44.25	33.75	74.00	H
7998.8	44.75	0	44.75	29.25	74.00	V
10407.1	46.29	4	42.29	27.71	74.00	V
15001.0	47.44	7	40.44	26.56	74.00	V

## RSE-11N-CH1-3GHz-18GHz

Frequency (MHz)	Average(dBμV/m)	ARpl (dB)	PMea (dBμV/m)	Margin(dB)	Limit(dBμV/m)	Polarity
3543.8	22.99	-10	32.99	31.01	54.00	H
4827.6	25.88	-7	32.88	28.12	54.00	H
6322.0	28.05	-4	32.05	25.95	54.00	H
7998.8	31.77	0	31.77	22.23	54.00	V
10407.1	33.44	4	29.44	20.56	54.00	V
15001.0	34.74	7	27.74	19.26	54.00	V

## RSE-11N-CH11-30M-1GHz

Frequency (MHz)	QuasiPeak(dBμV/m)	ARpl (dB)	PMea (dBμV/m)	Margin(dB)	Limit(dBμV/m)	Polarity
42.3	26.77	-13	39.77	13.23	40.00	V

## RSE-11N-CH11-1GHz-3GHz

Frequency (MHz)	MaxPeak(dBμV/m)	ARpl (dB)	PMea (dBμV/m)	Margin(dB)	Limit(dBμV/m)	Polarity
2532.0	52.96	16	36.96	21.04	74.00	V
2916.0	55.21	18	37.21	18.79	74.00	V

## RSE-11N-CH11-1GHz-3GHz

Frequency (MHz)	Average(dBμV/m)	ARpl (dB)	PMea (dBμV/m)	Margin(dB)	Limit(dBμV/m)	Polarity
-----------------	-----------------	-----------	---------------	------------	---------------	----------

2532.0	40.36	16	24.36	13.64	54.00	V
2916.0	42.56	18	24.56	11.44	54.00	V

## RSE-11N-CH11-3GHz-18GHz

Frequency (MHz)	MaxPeak(dBμV/m)	ARpl (dB)	PMea (dBμV/m)	Margin(dB)	Limit(dBμV/m)	Polarity
3538.1	35.95	-11	46.95	38.05	74.00	V
4484.5	37.62	-8	45.62	36.38	74.00	H
5518.1	40.48	-6	46.48	33.52	74.00	H
7964.1	44.49	0	44.49	29.51	74.00	H
10436.2	45.86	4	41.86	28.14	74.00	V
14556.1	48.13	7	41.13	25.87	74.00	V

## RSE-11N-CH11-3GHz-18GHz

Frequency (MHz)	Average(dBμV/m)	ARpl (dB)	PMea (dBμV/m)	Margin(dB)	Limit(dBμV/m)	Polarity
3538.1	23.1	-11	34.1	30.90	54.00	V
4484.5	25.13	-8	33.13	28.87	54.00	H
5518.1	27.37	-6	33.37	26.63	54.00	H
7964.1	31.47	0	31.47	22.53	54.00	H
10436.2	33.32	4	29.32	20.68	54.00	V
14556.1	34.79	7	27.79	19.21	54.00	V



**External antenna**
**RSE-11B-CH1-30MHz-1GHz**

Frequency (MHz)	QuasiPeak(dBμV/m)	ARpl (dB)	PMea (dBμV/m)	Margin(dB)	Limit(dBμV/m)	Polarity
42.0	30.77	-13	43.77	9.23	40.00	V
60.9	25.82	-13	38.82	14.18	40.00	V

**RSE-11B-CH1-1GHz-3GHz**

Frequency (MHz)	MaxPeak(dBμV/m)	ARpl (dB)	PMea (dBμV/m)	Margin(dB)	Limit(dBμV/m)	Polarity
2630.2	53.93	17	36.93	20.07	74.00	V
2944.4	56.03	19	37.03	17.97	74.00	H

**RSE-11B-CH1-1GHz-3GHz**

Frequency (MHz)	Average(dBμV/m)	ARpl (dB)	PMea (dBμV/m)	Margin(dB)	Limit(dBμV/m)	Polarity
2630.2	41.61	17	24.61	12.39	54.00	V
2944.4	43.24	19	24.24	10.76	54.00	H

**RSE-11B-CH1-3GHz-18GHz**

Frequency (MHz)	MaxPeak(dBμV/m)	ARpl (dB)	PMea (dBμV/m)	Margin(dB)	Limit(dBμV/m)	Polarity
4502.8	37.13	-8	45.13	36.87	74.00	V
17999.0	58.34	20	38.34	15.66	74.00	V

**RSE-11B-CH1-3GHz-18GHz**

Frequency (MHz)	Average(dBμV/m)	ARpl (dB)	PMea (dBμV/m)	Margin(dB)	Limit(dBμV/m)	Polarity
4502.8	24.68	-8	32.68	29.32	54.00	V
17999.0	44.79	20	24.79	9.21	54.00	V

**RSE-11B-CH11-30MHz-1GHz**

Frequency (MHz)	QuasiPeak(dBμV/m)	ARpl (dB)	PMea (dBμV/m)	Margin(dB)	Limit(dBμV/m)	Polarity
42.8	31.92	-13	44.92	8.08	40.00	V

**RSE-11B-CH11-1GHz-3GHz**

Frequency (MHz)	MaxPeak(dBμV/m)	ARpl (dB)	PMea (dBμV/m)	Margin(dB)	Limit(dBμV/m)	Polarity
2619.6	54.13	17	37.13	19.87	74.00	H
2859.2	54.71	18	36.71	19.29	74.00	V

**RSE-11B-CH11-1GHz-3GHz**

Frequency	Average(dBμV/m)	ARpl (dB)	PMea	Margin(dB)	Limit(dBμV/m)	Polarity
-----------	-----------------	-----------	------	------------	---------------	----------



(MHz)			(dB $\mu$ V/m)			
2619.6	41.22	17	24.22	12.78	54.00	H
2859.2	42.03	18	24.03	11.97	54.00	V

## RSE-11B-CH11-3GHz-18GHz

Frequency (MHz)	MaxPeak(dB $\mu$ V/m)	ARpl (dB)	PMea (dB $\mu$ V/m)	Margin(dB)	Limit(dB $\mu$ V/m)	Polarity
7365.0	42.27	-2	44.27	31.73	74.00	V
18000.0	57.69	20	37.69	16.31	74.00	V

## RSE-11B-CH11-3GHz-18GHz

Frequency (MHz)	Average(dB $\mu$ V/m)	ARpl (dB)	PMea (dB $\mu$ V/m)	Margin(dB)	Limit(dB $\mu$ V/m)	Polarity
7365.0	29.29	-2	31.29	24.71	54.00	V
18000.0	44.78	20	24.78	9.22	54.00	V

## RSE-11G-CH1-30MHz-1GHz

Frequency (MHz)	QuasiPeak(dB $\mu$ V/m)	ARpl (dB)	PMea (dB $\mu$ V/m)	Margin(dB)	Limit(dB $\mu$ V/m)	Polarity
42.4	29.83	-13	42.83	10.17	40.00	V

## RSE-11G-CH1-1GHz-3GHz

Frequency (MHz)	MaxPeak(dB $\mu$ V/m)	ARpl (dB)	PMea (dB $\mu$ V/m)	Margin(dB)	Limit(dB $\mu$ V/m)	Polarity
2608.3	53.5	17	36.5	20.50	74.00	V
2739.6	54.84	18	36.84	19.16	74.00	H

## RSE-11G-CH1-1GHz-3GHz

Frequency (MHz)	Average(dB $\mu$ V/m)	ARpl (dB)	PMea (dB $\mu$ V/m)	Margin(dB)	Limit(dB $\mu$ V/m)	Polarity
2608.3	40.92	17	23.92	13.08	54.00	V
2739.6	42.31	18	24.31	11.69	54.00	H

## RSE-11G-CH1-3GHz-18GHz

Frequency (MHz)	MaxPeak(dB $\mu$ V/m)	ARpl (dB)	PMea (dB $\mu$ V/m)	Margin(dB)	Limit(dB $\mu$ V/m)	Polarity
4827.1	43.08	-7	50.08	30.92	74.00	H
17998.1	57.75	20	37.75	16.25	74.00	H

## RSE-11G-CH1-3GHz-18GHz

Frequency (MHz)	Average(dB $\mu$ V/m)	ARpl (dB)	PMea (dB $\mu$ V/m)	Margin(dB)	Limit(dB $\mu$ V/m)	Polarity
4827.1	29.23	-7	36.23	24.77	54.00	H

17998.1	44.91	20	24.91	9.09	54.00	H
---------	-------	----	-------	------	-------	---

## RSE-11G-CH11-30MHz-1GHz

Frequency (MHz)	QuasiPeak(dBμV/m)	ARpl (dB)	PMea (dBμV/m)	Margin(dB)	Limit(dBμV/m)	Polarity
41.8	30.55	-13	43.55	9.45	40.00	V

## RSE-11G-CH11-1GHz-3GHz

Frequency (MHz)	MaxPeak(dBμV/m)	ARpl (dB)	PMea (dBμV/m)	Margin(dB)	Limit(dBμV/m)	Polarity
2559.5	52.67	16	36.67	21.33	74.00	V
2965.5	56.53	19	37.53	17.47	74.00	H

## RSE-11G-CH11-1GHz-3GHz

Frequency (MHz)	Average(dBμV/m)	ARpl (dB)	PMea (dBμV/m)	Margin(dB)	Limit(dBμV/m)	Polarity
2559.5	40.45	16	24.45	13.55	54.00	V
2965.5	43.32	19	24.32	10.68	54.00	H

## RSE-11G-CH11-3GHz-18GHz

Frequency (MHz)	MaxPeak(dBμV/m)	ARpl (dB)	PMea (dBμV/m)	Margin(dB)	Limit(dBμV/m)	Polarity
4922.9	41.94	-6	47.94	32.06	74.00	H
17968.1	57.98	19	38.98	16.02	74.00	H

## RSE-11G-CH11-3GHz-18GHz

Frequency (MHz)	Average(dBμV/m)	ARpl (dB)	PMea (dBμV/m)	Margin(dB)	Limit(dBμV/m)	Polarity
4922.9	28.17	-6	34.17	25.83	54.00	H
17968.1	44.44	19	25.44	9.56	54.00	H

## RSE-11N-CH1-30MHz-1GHz

Frequency (MHz)	QuasiPeak(dBμV/m)	ARpl (dB)	PMea (dBμV/m)	Margin(dB)	Limit(dBμV/m)	Polarity
42.1	31.5	-13	44.5	8.50	40.00	V

## RSE-11N-CH1-1GHz-3GHz

Frequency (MHz)	MaxPeak(dBμV/m)	ARpl (dB)	PMea (dBμV/m)	Margin(dB)	Limit(dBμV/m)	Polarity
2612.7	54.72	17	37.72	19.28	74.00	V
2774.0	54.68	18	36.68	19.32	74.00	V

## RSE-11N-CH1-1GHz-3GHz

Frequency (MHz)	Average(dBμV/m)	ARpl (dB)	PMea (dBμV/m)	Margin(dB)	Limit(dBμV/m)	Polarity
-----------------	-----------------	-----------	---------------	------------	---------------	----------



2612.7	41.14	17	24.14	12.86	54.00	V
2774.0	42.38	18	24.38	11.62	54.00	V

## RSE-11N-CH1-3GHz-18GHz

Frequency (MHz)	MaxPeak(dBμV/m)	ARpl (dB)	PMea (dBμV/m)	Margin(dB)	Limit(dBμV/m)	Polarity
4832.4	39.47	-7	46.47	34.53	74.00	H
17954.0	56.57	19	37.57	17.43	74.00	H

## RSE-11N-CH1-3GHz-18GHz

Frequency (MHz)	Average(dBμV/m)	ARpl (dB)	PMea (dBμV/m)	Margin(dB)	Limit(dBμV/m)	Polarity
4832.4	26.52	-7	33.52	27.48	54.00	H
17954.0	43.78	19	24.78	10.22	54.00	H

## RSE-11N-CH11-30MHz-1GHz

Frequency (MHz)	QuasiPeak(dBμV/m)	ARpl (dB)	PMea (dBμV/m)	Margin(dB)	Limit(dBμV/m)	Polarity
42.4	29.77	-13	42.77	10.23	40.00	V

## RSE-11N-CH11-1GHz-3GHz

Frequency (MHz)	MaxPeak(dBμV/m)	ARpl (dB)	PMea (dBμV/m)	Margin(dB)	Limit(dBμV/m)	Polarity
2620.2	53.94	17	36.94	20.06	74.00	H
2832.4	54.95	18	36.95	19.05	74.00	V

## RSE-11N-CH11-1GHz-3GHz

Frequency (MHz)	Average(dBμV/m)	ARpl (dB)	PMea (dBμV/m)	Margin(dB)	Limit(dBμV/m)	Polarity
2620.2	41.23	17	24.23	12.77	54.00	H
2832.4	42.17	18	24.17	11.83	54.00	V

## RSE-11N-CH11-3GHz-18GHz

Frequency (MHz)	MaxPeak(dBμV/m)	ARpl (dB)	PMea (dBμV/m)	Margin(dB)	Limit(dBμV/m)	Polarity
10369.2	45.66	3	42.66	28.34	74.00	V
17995.2	56.76	20	36.76	17.24	74.00	H

## RSE-11N-CH11-3GHz-18GHz

Frequency (MHz)	Average(dBμV/m)	ARpl (dB)	PMea (dBμV/m)	Margin(dB)	Limit(dBμV/m)	Polarity
10369.2	32.93	3	29.93	21.07	54.00	V
17995.2	44.55	20	24.55	9.45	54.00	H



## 6.9 AC Powerline Conducted Emission

### 6.9.1 Method of Measurement: ANSI C63.10-2013-clause 6.2

1. The one EUT cable configuration and arrangement and mode of operation that produced the emission with the highest amplitude relative to the limit is selected for the final measurement, while applying the appropriate modulating signal to the EUT.
2. If the EUT is relocated from an exploratory test site to a final test site, the highest emissions shall be remaximized at the final test location before final ac power-line conducted emission measurements are performed.
3. The final test on all current-carrying conductors of all of the power cords to the equipment that comprises the EUT (but not the cords associated with other non-EUT equipment in the system) is then performed for the full frequency range for which the EUT is being tested for compliance without further variation of the EUT arrangement, cable positions, or EUT mode of operation.
4. If the EUT is comprised of equipment units that have their own separate ac power connections, e.g., floor-standing equipment with independent power cords for each shelf that are able to connect directly to the ac power network, each current-carrying conductor of one unit is measured while the other units are connected to a second (or more) LISN(s). All units shall be separately measured. If a power strip is provided by the manufacturer, to supply all of the units making up the EUT, only the conductors in the power cord of the power strip shall be measured.

If the EUT uses a detachable antenna, these measurements shall be made with a suitable dummy load connected to the antenna output terminals; otherwise, the tests shall be made with the antenna connected and, if adjustable, fully extended. When measuring the ac conducted emissions from a device that operates between 150 kHz and 30 MHz a non-detachable antenna may be replaced with a dummy load for the measurements within the fundamental emission band of the transmitter, but only for those measurements.<sup>36</sup> Record the six highest EUT emissions relative to the limit of each of the current-carrying conductors of the power cords of the equipment that comprises the EUT over the frequency range specified by the procuring or regulatory agency. Diagram or photograph the test setup that was used. See Clause 8 for full reporting requirements.

6.9.2 Test Setup

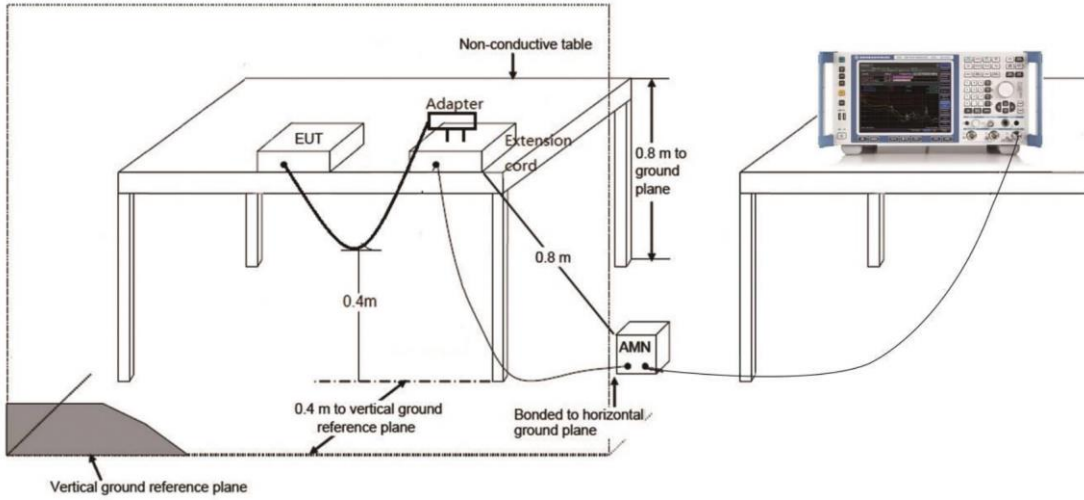

6.9.3 Test Condition

Voltage (V)	Frequency (Hz)
120	60

6.9.4 Measurement limit

(Quasi-peak-average Limit)

Frequency range (MHz)	Quasi-peak Limit (dBμV)	Average Limit (dBμV)	Conclusion
0.15 to 0.5	66 to 56	56 to 46	P
0.5 to 5	56	46	
5 to 30	60	50	

NOTE: The limit decreases linearly with the logarithm of the frequency in the range 0.15 MHz to 0.5 MHz.

6.9.5 Measurement Result

Because the EUT is battery powered or charged by solar energy, adapter-related tests cannot be performed. Therefore, this test item is not applicable.



**Annex A: Revised History**

Version	Revised Content
V0	Initial
V1	Update section 1.3&4.3&5.2&6.9
V2	Add external antenna data



Annex B: Accreditation Certificate



**Accredited Laboratory**

A2LA has accredited

**INDUSTRIAL INTERNET INNOVATION CENTER  
(SHANGHAI) CO., LTD.**  
Shanghai, People's Republic of China

for technical competence in the field of

**Electrical Testing**

This laboratory is accredited in accordance with the recognized International Standard ISO/IEC 17025:2017 *General requirements for the competence of testing and calibration laboratories*. This accreditation demonstrates technical competence for a defined scope and the operation of a laboratory quality management system (refer to joint ISO-ILAC-IAF Communiqué dated April 2017).



Presented this 20<sup>th</sup> day of September 2023.



Mr. Trace McInturff, Vice President, Accreditation Services  
For the Accreditation Council  
Certificate Number 3682.01  
Valid to February 28, 2025

For the tests to which this accreditation applies, please refer to the laboratory's Electrical Scope of Accreditation.

END OF REPORT