

Remote Flip Key – Label Details



Remote Flip Key Wave1/Wave2 LABEL DOCUMENT

Project Name:

Wave2- **Remote Key** (Model no 30037AZ)

Wave1- **Remote Key** (Model no 30037CZ)

Author	Nirmlesh
Version	3.0

<h2>Remote Flip Key – Label Details</h2>	
--	---

Document revision history:

Sr No	Status	Version	Date	Change description	Author
1	Initial	1.0	19/01/2024	Initial Release	Nirmlesh K
2	Rev-1	2.0	25/01/2024	433.92MHZ was 434 MHz	Nirmlesh K
3	Rev-2	3.0	27/01/2024	GRANTEE code added in FCC markings	Nirmlesh K

Remote Flip Key – Label Details	
--	---

Table of Contents

Contents

1 INTRODUCTION	4
1.2 Dimension of Label area	4
2. Label Details	5
2.1 Model 30037AZ	5
2.1 Dimension Details of Manufacturer Logo	5
2.2 For Text	6
2.3 Model 30037CZ	6

Remote Flip Key – Label Details



1 INTRODUCTION

This Document describes Label to be put on Remote Flip key

The area identified is as below

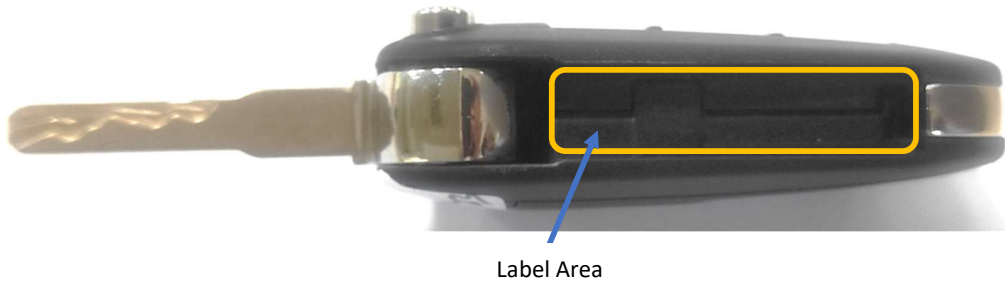

1.2 Dimension of Label area

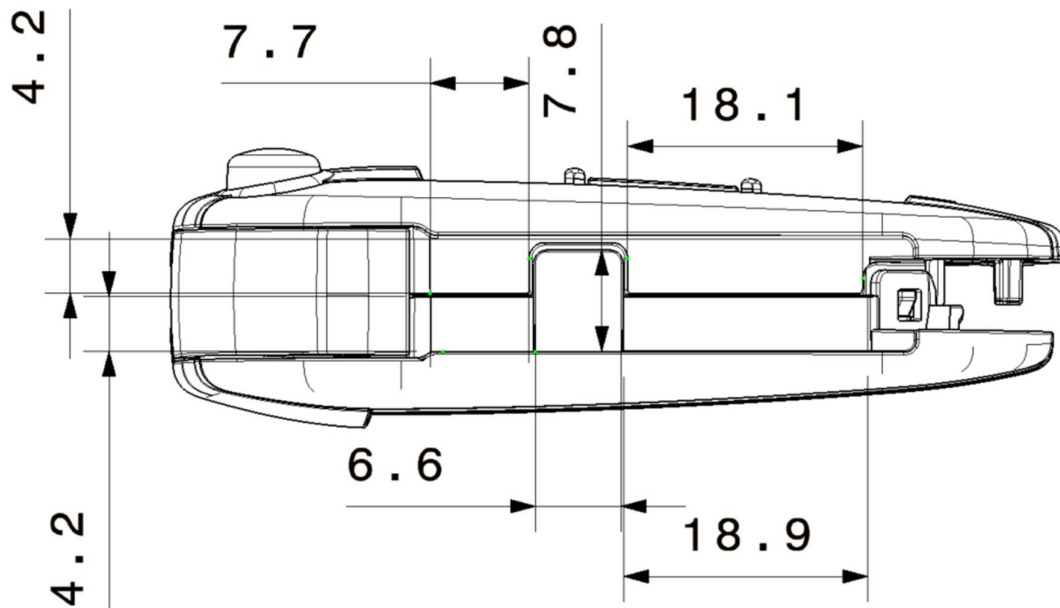

Remote Flip Key – Label Details



2. Label Details

2.1 Model 30037AZ*

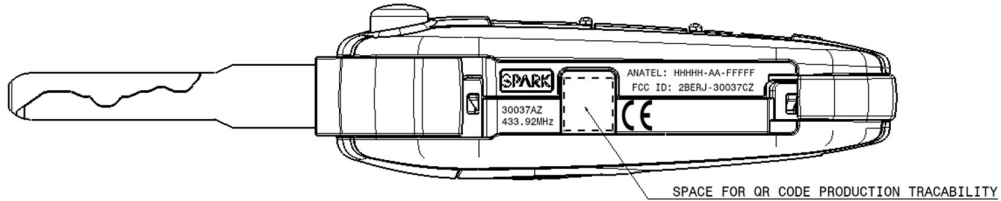

WAVE 2

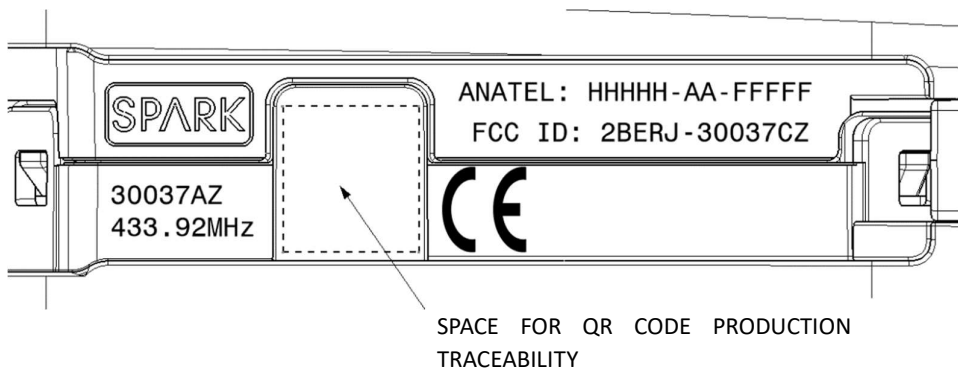

2.1 Dimension Details of Manufacturer Logo

Dimensions shown is in “mm”



Remote Flip Key – Label Details



2.2 For Text

ANATEL : HHHHH-AA-FFFFF 1.9 mm

FCC ID: 2BERJ-30037CZ 1.9 mm

30037AZ 1.9 mm

433.92MHz 1.9mm



2.3 Model 30037CZ

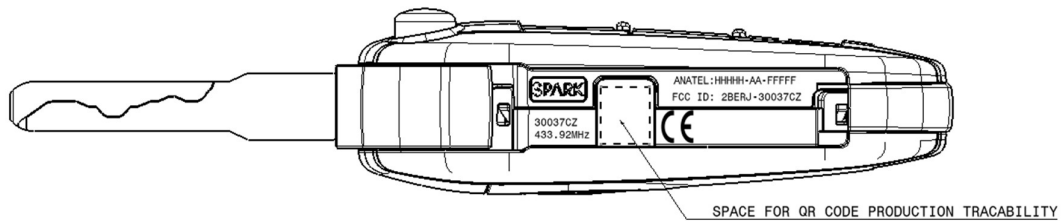

WAVE 1

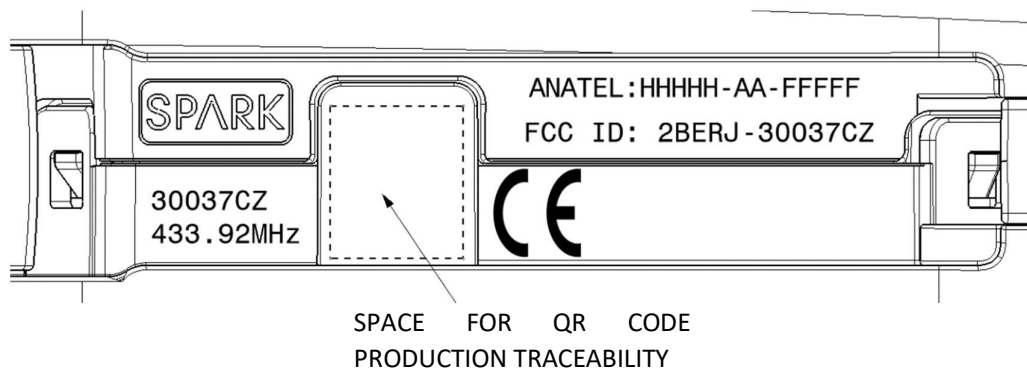

END of DOC