



TEST REPORT

| | | |
|--|---|---|
| FCC ID : | 2BEQO-T31 | |
| Test Report No : | TCT240513E015 | |
| Date of issue : | May 20, 2024 | |
| Testing laboratory | SHENZHEN TONGCE TESTING LAB | |
| Testing location/ address: | 2101 & 2201, Zhenchang Factory Renshan Industrial Zone, Fuhai Subdistrict, Bao'an District, Shenzhen, Guangdong, 518103, People's Republic of China | |
| Applicant's name : | SHENZHEN HAOCHENG TECHNOLOGY CO., LTD | |
| Address : | 501, Main Building, Qiaocheng No.1 Plaza, No.2 shenyun Road, Gaofa Community, Shahe Street, Nanshan District, Shenzhen city 518000, China | |
| Manufacturer's name ... : | SHENZHEN HAOCHENG TECHNOLOGY CO., LTD | |
| Address : | 501, Main Building, Qiaocheng No.1 Plaza, No.2 shenyun Road, Gaofa Community, Shahe Street, Nanshan District, Shenzhen city 518000, China | |
| Standard(s) | FCC CFR Title 47 Part 15 Subpart C Section 15.247 FCC KDB 558074 D01 15.247 Meas Guidance v05r02 ANSI C63.10:2013 | |
| Product Name : | Smart Band | |
| Trade Mark | N/A | |
| Model/Type reference : | T31 | |
| Rating(s) : | Rechargeable Li-ion Battery DC 3.7V | |
| Date of receipt of test item | May 13, 2024 | |
| Date (s) of performance of test : | May 13, 2024 ~ May 20, 2024 | |
| Tested by (+signature) ... : | Yannie ZHONG |  |
| Check by (+signature) : | Beryl ZHAO |  |
| Approved by (+signature): | Tomsin |  |



General disclaimer:

This report shall not be reproduced except in full, without the written approval of SHENZHEN TONGCE TESTING LAB. This document may be altered or revised by SHENZHEN TONGCE TESTING LAB personnel only, and shall be noted in the revision section of the document. The test results in the report only apply to the tested sample.

Table of Contents

| | |
|--|----------|
| 1. General Product Information | 3 |
| 1.1. EUT description | 3 |
| 1.2. Model(s) list..... | 3 |
| 1.3. Operation Frequency | 3 |
| 2. Test Result Summary | 4 |
| 3. General Information..... | 5 |
| 3.1. Test environment and mode..... | 5 |
| 3.2. Description of Support Units..... | 5 |
| 4. Facilities and Accreditations | 6 |
| 4.1. Facilities | 6 |
| 4.2. Location | 6 |
| 4.3. Measurement Uncertainty..... | 6 |
| 5. Test Results and Measurement Data | 7 |
| 5.1. Antenna requirement | 7 |
| 5.2. Conducted Emission..... | 8 |
| 5.3. Conducted Output Power | 12 |
| 5.4. Emission Bandwidth | 13 |
| 5.5. Power Spectral Density..... | 14 |
| 5.6. Conducted Band Edge and Spurious Emission Measurement | 15 |
| 5.7. Radiated Spurious Emission Measurement..... | 17 |
| Appendix A: Test Result of Conducted Test | |
| Appendix B: Photographs of Test Setup | |
| Appendix C: Photographs of EUT | |

1. General Product Information

1.1. EUT description

| | |
|----------------------------|-------------------------------------|
| Product Name.....: | Smart Band |
| Model/Type reference.....: | T31 |
| Sample Number.....: | TCT240513E015-0101 |
| Bluetooth Version | V5.2 |
| Operation Frequency | 2402MHz~2480MHz |
| Channel Separation.....: | 2MHz |
| Data Rate.....: | LE 1M PHY, LE 2M PHY |
| Number of Channel | 40 |
| Modulation Type | GFSK |
| Antenna Type.....: | Internal Antenna |
| Antenna Gain.....: | -9.98dBi |
| Rating(s).....: | Rechargeable Li-ion Battery DC 3.7V |

Note: The antenna gain listed in this report is provided by applicant, and the test laboratory is not responsible for this parameter.

1.2. Model(s) list

None.

1.3. Operation Frequency

| Channel | Frequency | Channel | Frequency | Channel | Frequency | Channel | Frequency |
|---------|-----------|---------|-----------|---------|-----------|---------|-----------|
| 0 | 2402MHz | 10 | 2422MHz | 20 | 2442MHz | 30 | 2462MHz |
| 1 | 2404MHz | 11 | 2424MHz | 21 | 2444MHz | 31 | 2464MHz |
| ... | ... | ... | ... | ... | ... | ... | ... |
| 8 | 2418MHz | 18 | 2438MHz | 28 | 2458MHz | 38 | 2478MHz |
| 9 | 2420MHz | 19 | 2440MHz | 29 | 2460MHz | 39 | 2480MHz |

Remark: Channel 0, 19 & 39 have been tested.

2. Test Result Summary

| Requirement | CFR 47 Section | Result |
|----------------------------------|---------------------|--------|
| Antenna requirement | §15.203/§15.247 (c) | PASS |
| AC Power Line Conducted Emission | §15.207 | PASS |
| Conducted Peak Output Power | §15.247 (b)(3) | PASS |
| 6dB Emission Bandwidth | §15.247 (a)(2) | PASS |
| Power Spectral Density | §15.247 (e) | PASS |
| Band Edge | §15.247(d) | PASS |
| Spurious Emission | §15.205/§15.209 | PASS |

Note:

1. PASS: Test item meets the requirement.
2. Fail: Test item does not meet the requirement.
3. N/A: Test case does not apply to the test object.
4. The test result judgment is decided by the limit of test standard.

3. General Information

3.1. Test environment and mode

| Operating Environment: | | |
|---|--|-------------------|
| Condition | Conducted Emission | Radiated Emission |
| Temperature: | 24.9 °C | 24.1 °C |
| Humidity: | 49 % RH | 53 % RH |
| Atmospheric Pressure: | 1010 mbar | 1010 mbar |
| Test Software: | | |
| Software Information: | RTL8762x_RFTTestTool_v1.0.2.7 | |
| Power Level: | 0 | |
| Test Mode: | | |
| Engineer mode: | Keep the EUT in continuous transmitting by select channel and modulations with Fully-charged battery | |
| <p>The sample was placed 0.8m & 1.5m for the measurement below & above 1GHz above the ground plane of 3m chamber. Measurements in both horizontal and vertical polarities were performed. During the test, each emission was maximized by: having the EUT continuously working, investigated all operating modes, rotated about all 3 axis (X, Y & Z) and considered typical configuration to obtain worst position, manipulating interconnecting cables, rotating the turntable, varying antenna height from 1m to 4m in both horizontal and vertical polarizations. The emissions worst-case (Z axis) are shown in Test Results of the following pages.</p> | | |

3.2. Description of Support Units

The EUT has been tested as an independent unit together with other necessary accessories or support units. The following support units or accessories were used to form a representative test configuration during the tests.

| Equipment | Model No. | Serial No. | FCC ID | Trade Name |
|-----------|-----------|----------------|--------|------------|
| Adapter | EP-TA200 | R37M4PR7QD4SE3 | / | SAMSUNG |

Note:

1. All the equipment/cables were placed in the worst-case configuration to maximize the emission during the test.
2. Grounding was established in accordance with the manufacturer's requirements and conditions for the intended use.
3. For conducted measurements (Output Power, 6dB Emission Bandwidth, Power Spectral Density, Spurious Emissions), the antenna of EUT is connected to the test equipment via temporary antenna connector, the antenna connector is soldered on the antenna port of EUT, and the temporary antenna connector is listed in the Test Instruments.

4. Facilities and Accreditations

4.1. Facilities

The test facility is recognized, certified, or accredited by the following organizations:

- FCC - Registration No.: 645098
SHENZHEN TONGCE TESTING LAB
Designation Number: CN1205

The testing lab has been registered and fully described in a report with the (FCC) Federal Communications Commission. The acceptance letter from the FCC is maintained in our files.

- IC - Registration No.: 10668A-1
SHENZHEN TONGCE TESTING LAB
CAB identifier: CN0031

The testing lab has been registered by Certification and Engineering Bureau of Industry Canada for radio equipment testing.

4.2. Location

SHENZHEN TONGCE TESTING LAB

Address: 2101 & 2201, Zhenchang Factory Renshan Industrial Zone, Fuhai Subdistrict, Bao'an District, Shenzhen, Guangdong, 518103, People's Republic of China

TEL: +86-755-27673339

4.3. Measurement Uncertainty

The reported uncertainty of measurement $y \pm U$, where expanded uncertainty U is based on a standard uncertainty multiplied by a coverage factor of $k=2$, providing a level of confidence of approximately 95 %.

| No. | Item | MU |
|-----|---|---------------|
| 1 | Conducted Emission | ± 3.10 dB |
| 2 | RF power, conducted | ± 0.12 dB |
| 3 | Spurious emissions, conducted | ± 0.11 dB |
| 4 | All emissions, radiated(<1 GHz) | ± 4.56 dB |
| 5 | All emissions, radiated(1 GHz - 18 GHz) | ± 4.22 dB |
| 6 | All emissions, radiated(18 GHz- 40 GHz) | ± 4.36 dB |

5. Test Results and Measurement Data

5.1. Antenna requirement

| | |
|--|-------------------------------------|
| Standard requirement: | FCC Part15 C Section 15.203 /247(c) |
| <p>15.203 requirement: An intentional radiator shall be designed to ensure that no antenna other than that furnished by the responsible party shall be used with the device. The use of a permanently attached antenna or of an antenna that uses a unique coupling to the intentional radiator, the manufacturer may design the unit so that a broken antenna can be replaced by the user, but the use of a standard antenna jack or electrical connector is prohibited.</p> <p>15.247(c) (1)(i) requirement: (i) Systems operating in the 2400-2483.5 MHz band that is used exclusively for fixed. Point-to-point operations may employ transmitting antennas with directional gain greater than 6dBi provided the maximum conducted output power of the intentional radiator is reduced by 1 dB for every 3 dB that the directional gain of the antenna exceeds 6dBi.</p> | |
| E.U.T Antenna: | |
| <p>The Bluetooth antenna is Internal antenna which permanently attached, and the best case gain of the antenna is -9.98dBi.</p> | |

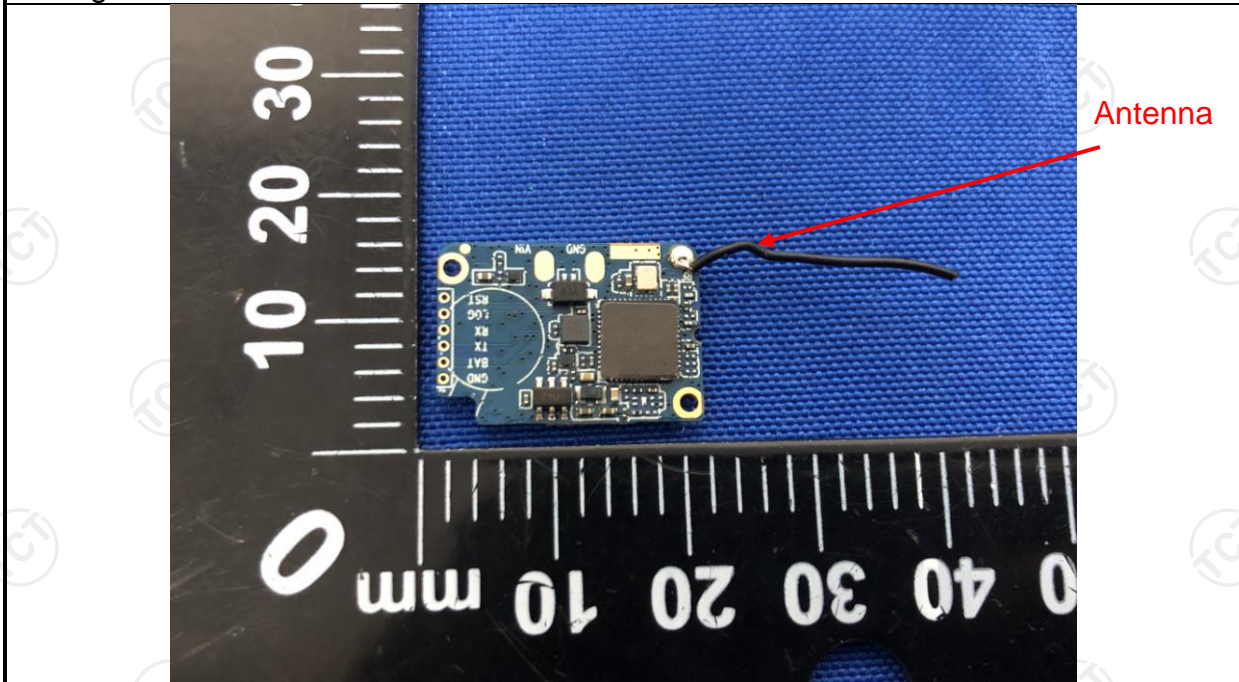

5.2. Conducted Emission

5.2.1. Test Specification

| Test Requirement: | FCC Part15 C Section 15.207 | | | | | | | | | | | | | | |
|--------------------------|--|-----------------------|--------------|--|------------|---------|----------|-----------|-----------|-------|----|----|------|----|----|
| Test Method: | ANSI C63.10:2013 | | | | | | | | | | | | | | |
| Frequency Range: | 150 kHz to 30 MHz | | | | | | | | | | | | | | |
| Receiver setup: | RBW=9 kHz, VBW=30 kHz, Sweep time=auto | | | | | | | | | | | | | | |
| Limits: | <table border="1"> <thead> <tr> <th rowspan="2">Frequency range (MHz)</th> <th colspan="2">Limit (dBuV)</th> </tr> <tr> <th>Quasi-peak</th> <th>Average</th> </tr> </thead> <tbody> <tr> <td>0.15-0.5</td> <td>66 to 56*</td> <td>56 to 46*</td> </tr> <tr> <td>0.5-5</td> <td>56</td> <td>46</td> </tr> <tr> <td>5-30</td> <td>60</td> <td>50</td> </tr> </tbody> </table> | Frequency range (MHz) | Limit (dBuV) | | Quasi-peak | Average | 0.15-0.5 | 66 to 56* | 56 to 46* | 0.5-5 | 56 | 46 | 5-30 | 60 | 50 |
| Frequency range (MHz) | Limit (dBuV) | | | | | | | | | | | | | | |
| | Quasi-peak | Average | | | | | | | | | | | | | |
| 0.15-0.5 | 66 to 56* | 56 to 46* | | | | | | | | | | | | | |
| 0.5-5 | 56 | 46 | | | | | | | | | | | | | |
| 5-30 | 60 | 50 | | | | | | | | | | | | | |
| Test Setup: | <p><i>Remark</i> E.U.T: Equipment Under Test LISN: Line Impedance Stabilization Network Test table height=0.8m</p> | | | | | | | | | | | | | | |
| Test Mode: | Charging + Transmitting Mode | | | | | | | | | | | | | | |
| Test Procedure: | <ol style="list-style-type: none"> 1. The E.U.T is connected to an adapter through a line impedance stabilization network (L.I.S.N.). This provides a 50ohm/50uH coupling impedance for the measuring equipment. 2. The peripheral devices are also connected to the main power through a LISN that provides a 50ohm/50uH coupling impedance with 50ohm termination. (Please refer to the block diagram of the test setup and photographs). 3. Both sides of A.C. line are checked for maximum conducted interference. In order to find the maximum emission, the relative positions of equipment and all of the interface cables must be changed according to ANSI C63.10:2013 on conducted measurement. | | | | | | | | | | | | | | |
| Test Result: | PASS | | | | | | | | | | | | | | |

5.2.2. Test Instruments

| Conducted Emission Shielding Room Test Site (843) | | | | |
|---|--------------------|-----------|---------------|-----------------|
| Equipment | Manufacturer | Model | Serial Number | Calibration Due |
| EMI Test Receiver | R&S | ESCI3 | 100898 | Jun. 29, 2024 |
| Line Impedance Stabilisation Newtork(LISN) | Schwarzbeck | NSLK 8126 | 8126453 | Feb. 01, 2025 |
| Line-5 | TCT | CE-05 | / | Jul. 03, 2024 |
| EMI Test Software | Shurple Technology | EZ-EMC | / | / |

5.2.3. Test data

Please refer to following diagram for individual

Conducted Emission on Line Terminal of the power line (150 kHz to 30MHz)

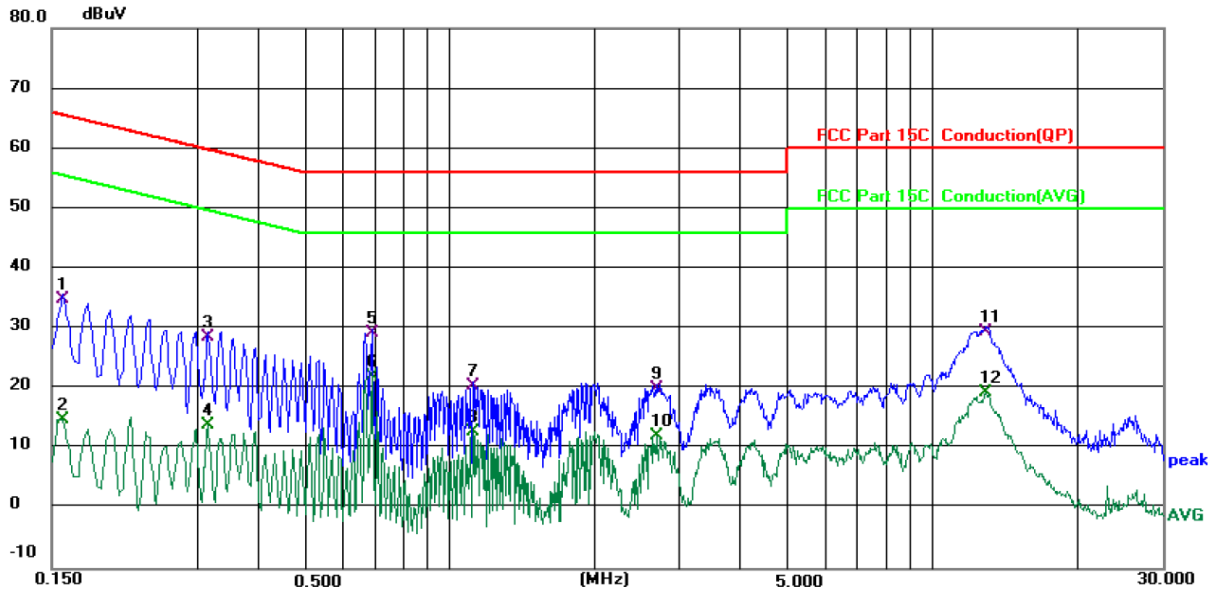

Site 844 Shielding Room

Phase: L1

Temperature: 24.4 (°C)

Humidity: 49 %

Limit: FCC Part 15C Conduction(QP)

Power: DC 5 V(Adapter Input AC 120 V/60 Hz)

| No. | Mk. | Freq. MHz | Reading Level dBuV | Correct Factor dB | Measure- ment dBuV | Limit dBuV | Over dB | Detector | Comment |
|-----|-----|--------------|--------------------------|-------------------------|--------------------------|---------------|------------|----------|---------|
| 1 | | 0.1573 | 24.89 | 10.03 | 34.92 | 65.61 | -30.69 | QP | |
| 2 | | 0.1573 | 4.83 | 10.03 | 14.86 | 55.61 | -40.75 | AVG | |
| 3 | | 0.3140 | 18.77 | 9.84 | 28.61 | 59.86 | -31.25 | QP | |
| 4 | | 0.3140 | 4.16 | 9.84 | 14.00 | 49.86 | -35.86 | AVG | |
| 5 | | 0.6900 | 20.05 | 9.17 | 29.22 | 56.00 | -26.78 | QP | |
| 6 | * | 0.6900 | 12.95 | 9.17 | 22.12 | 46.00 | -23.88 | AVG | |
| 7 | | 1.1220 | 10.60 | 9.91 | 20.51 | 56.00 | -35.49 | QP | |
| 8 | | 1.1220 | 2.83 | 9.91 | 12.74 | 46.00 | -33.26 | AVG | |
| 9 | | 2.6819 | 9.92 | 10.12 | 20.04 | 56.00 | -35.96 | QP | |
| 10 | | 2.6819 | 2.15 | 10.12 | 12.27 | 46.00 | -33.73 | AVG | |
| 11 | | 12.9580 | 18.91 | 10.64 | 29.55 | 60.00 | -30.45 | QP | |
| 12 | | 12.9580 | 8.82 | 10.64 | 19.46 | 50.00 | -30.54 | AVG | |

Note:

Freq. = Emission frequency in MHz

Reading level (dBuV) = Receiver reading

Corr. Factor (dB) = LISN factor + Cable loss

Measurement (dBuV) = Reading level (dBuV) + Corr. Factor (dB)

Limit (dBuV) = Limit stated in standard

Margin (dB) = Measurement (dBuV) – Limits (dBuV)

Q.P. =Quasi-Peak

AVG =average

* is meaning the worst frequency has been tested in the frequency range 150 kHz to 30MHz

Conducted Emission on Neutral Terminal of the power line (150 kHz to 30MHz)

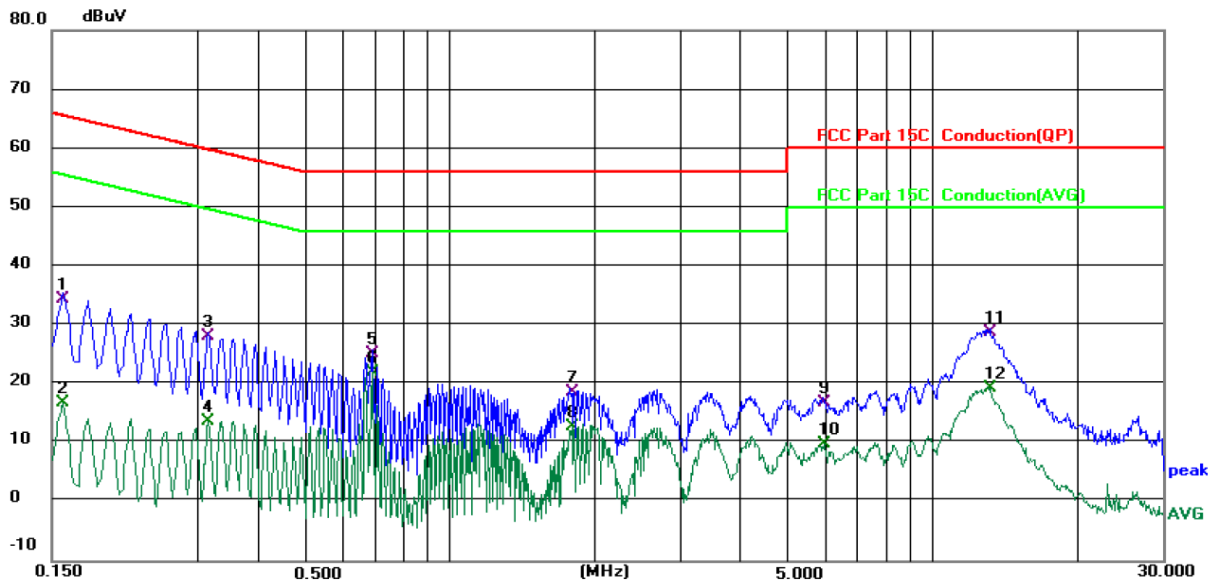

Site 844 Shielding Room Phase: **N** Temperature: 24.4 (°C) Humidity: 49 %
Limit: FCC Part 15C Conduction(QP) Power: DC 5 V(Adapter Input AC 120 V/60 Hz)

| No. | Mk. | Freq. MHz | Reading Level dBuV | Correct Factor dB | Measure- ment dBuV | Limit dBuV | Over dB | Detector | Comment |
|-----|-----|--------------|--------------------------|-------------------------|--------------------------|---------------|------------|----------|---------|
| 1 | | 0.1580 | 24.50 | 10.01 | 34.51 | 65.57 | -31.06 | QP | |
| 2 | | 0.1580 | 6.79 | 10.01 | 16.80 | 55.57 | -38.77 | AVG | |
| 3 | | 0.3140 | 18.40 | 9.82 | 28.22 | 59.86 | -31.64 | QP | |
| 4 | | 0.3140 | 3.83 | 9.82 | 13.65 | 49.86 | -36.21 | AVG | |
| 5 | | 0.6900 | 16.17 | 9.14 | 25.31 | 56.00 | -30.69 | QP | |
| 6 | * | 0.6900 | 12.99 | 9.14 | 22.13 | 46.00 | -23.87 | AVG | |
| 7 | | 1.7940 | 8.80 | 9.96 | 18.76 | 56.00 | -37.24 | QP | |
| 8 | | 1.7940 | 2.80 | 9.96 | 12.76 | 46.00 | -33.24 | AVG | |
| 9 | | 5.9699 | 6.52 | 10.39 | 16.91 | 60.00 | -43.09 | QP | |
| 10 | | 5.9699 | -0.56 | 10.39 | 9.83 | 50.00 | -40.17 | AVG | |
| 11 | | 13.2019 | 18.18 | 10.62 | 28.80 | 60.00 | -31.20 | QP | |
| 12 | | 13.2019 | 8.65 | 10.62 | 19.27 | 50.00 | -30.73 | AVG | |

Note1:

Freq. = Emission frequency in MHz

Reading level (dBuV) = Receiver reading

Corr. Factor (dB) = LISN factor + Cable loss

Measurement (dBuV) = Reading level (dBuV) + Corr. Factor (dB)

Limit (dBuV) = Limit stated in standard

Margin (dB) = Measurement (dBuV) – Limits (dBuV)

Q.P. =Quasi-Peak

AVG =average

* is meaning the worst frequency has been tested in the frequency range 150 kHz to 30MHz.

Note2: Speed for 1M and 2M modulations of EUT have been tested, but the test data only show the worst case in this report, and we found the worst case is 2M speed modulation. Measurements were conducted in all three channels (high, middle, low), and the worst case Mode (Highest channel) was submitted only.

5.3. Conducted Output Power

5.3.1. Test Specification

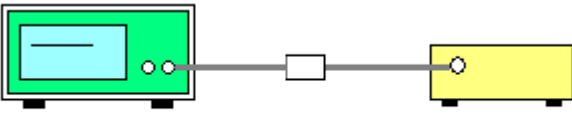
| | |
|--------------------------|--|
| Test Requirement: | FCC Part15 C Section 15.247 (b)(3) |
| Test Method: | KDB 558074 D01 v05r02 |
| Limit: | 30dBm |
| Test Setup: |  <p style="text-align: center;">Spectrum Analyzer EUT</p> |
| Test Mode: | Refer to item 3.1 |
| Test Procedure: | <p>Set spectrum analyzer as following:</p> <ul style="list-style-type: none"> a) Set the RBW \geq DTS bandwidth. b) Set VBW $\geq 3 \times$ RBW. c) Set span $\geq 3 \times$ RBW d) Sweep time = auto couple. e) Detector = peak. f) Trace mode = max hold. g) Allow trace to fully stabilize. h) Use peak marker function to determine the peak amplitude level. |
| Test Result: | PASS |

5.3.2. Test Instruments

| Name | Manufacturer | Model No. | Serial Number | Calibration Due |
|-------------------|--------------|-----------|---------------|-----------------|
| Spectrum Analyzer | Agilent | N9020A | MY49100619 | Jun. 28, 2024 |
| Combiner Box | Ascentest | AT890-RFB | / | / |

5.4. Emission Bandwidth

5.4.1. Test Specification

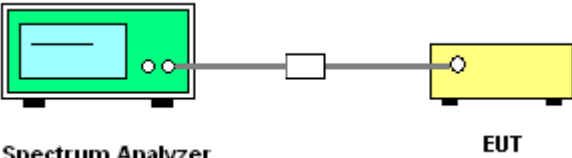
| | |
|--------------------------|---|
| Test Requirement: | FCC Part15 C Section 15.247 (a)(2) |
| Test Method: | KDB 558074 D01 v05r02 |
| Limit: | >500kHz |
| Test Setup: |  <p style="text-align: center;">Spectrum Analyzer EUT</p> |
| Test Mode: | Refer to item 3.1 |
| Test Procedure: | <ol style="list-style-type: none"> 1. Set to the maximum power setting and enable the EUT transmit continuously. 2. Make the measurement with the spectrum analyzer's resolution bandwidth (RBW) = 100 kHz. Set the Video bandwidth (VBW) = 300 kHz. In order to make an accurate measurement. The 6dB bandwidth must be greater than 500 kHz. 3. Measure and record the results in the test report. |
| Test Result: | PASS |

5.4.2. Test Instruments

| Name | Manufacturer | Model No. | Serial Number | Calibration Due |
|-------------------|--------------|-----------|---------------|-----------------|
| Spectrum Analyzer | Agilent | N9020A | MY49100619 | Jun. 28, 2024 |
| Combiner Box | Ascentest | AT890-RFB | / | / |

5.5. Power Spectral Density

5.5.1. Test Specification

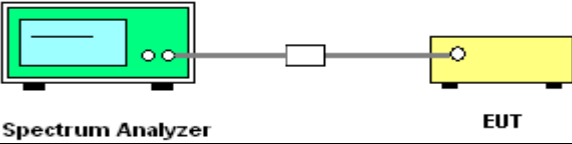
| | |
|--------------------------|--|
| Test Requirement: | FCC Part15 C Section 15.247 (e) |
| Test Method: | KDB 558074 D01 v05r02 |
| Limit: | The peak power spectral density shall not be greater than 8dBm in any 3kHz band at any time interval of continuous transmission. |
| Test Setup: |  <p style="text-align: center;">Spectrum Analyzer EUT</p> |
| Test Mode: | Refer to item 3.1 |
| Test Procedure: | <ol style="list-style-type: none"> 1. The RF output of EUT was connected to the spectrum analyzer by RF cable and attenuator. The path loss was compensated to the results for each measurement. 2. Set to the maximum power setting and enable the EUT transmit continuously. 3. Make the measurement with the spectrum analyzer's resolution bandwidth (RBW): $3 \text{ kHz} \leq \text{RBW} \leq 100 \text{ kHz}$. Video bandwidth VBW $\geq 3 \times \text{RBW}$. In order to make an accurate measurement, set the span to 1.5 times DTS Channel Bandwidth. (6dB BW) 4. Detector = peak, Sweep time = auto couple, Trace mode = max hold, Allow trace to fully stabilize. Use the peak marker function to determine the maximum power level. 5. Measure and record the results in the test report. |
| Test Result: | PASS |

5.5.2. Test Instruments

| Name | Manufacturer | Model No. | Serial Number | Calibration Due |
|-------------------|--------------|-----------|---------------|-----------------|
| Spectrum Analyzer | Agilent | N9020A | MY49100619 | Jun. 28, 2024 |
| Combiner Box | Ascentest | AT890-RFB | / | / |

5.6. Conducted Band Edge and Spurious Emission Measurement

5.6.1. Test Specification

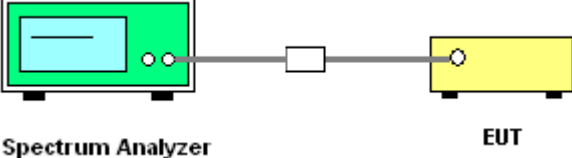
| | |
|--------------------------|---|
| Test Requirement: | FCC Part15 C Section 15.247 (d) |
| Test Method: | KDB 558074 D01 v05r02 |
| Limit: | In any 100 kHz bandwidth outside of the authorized frequency band, the emissions which fall in the non-restricted bands shall be attenuated at least 20 dB / 30dB relative to the maximum PSD level in 100 kHz by RF conducted measurement and radiated emissions which fall in the restricted bands, as defined in Section 15.205(a), must also comply with the radiated emission limits specified in Section 15.209(a). |
| Test Setup: |  <p style="text-align: center;">Spectrum Analyzer EUT</p> |
| Test Mode: | Refer to item 3.1 |
| Test Procedure: | <ol style="list-style-type: none"> 1. The RF output of EUT was connected to the spectrum analyzer by RF cable and attenuator. The path loss was compensated to the results for each measurement. 2. Set to the maximum power setting and enable the EUT transmit continuously. 3. Set RBW = 100 kHz, VBW=300 kHz, Peak Detector. Unwanted Emissions measured in any 100 kHz bandwidth outside of the authorized frequency band shall be attenuated by at least 20 dB relative to the maximum in-band peak PSD level in 100 kHz when maximum peak conducted output power procedure is used. If the transmitter complies with the conducted power limits based on the use of RMS averaging over a time interval, the attenuation required under this paragraph shall be 30 dB instead of 20 dB per 15.247(d). 4. Measure and record the results in the test report. 5. The RF fundamental frequency should be excluded against the limit line in the operating frequency band. |
| Test Result: | PASS |

5.6.2. Test Instruments

| Name | Manufacturer | Model No. | Serial Number | Calibration Due |
|-------------------|--------------|-----------|---------------|-----------------|
| Spectrum Analyzer | Agilent | N9020A | MY49100619 | Jun. 28, 2024 |
| Combiner Box | Ascentest | AT890-RFB | / | / |

5.7. Radiated Spurious Emission Measurement

5.7.1. Test Specification

| | | | | | | |
|------------------------------|---|-----------------------------------|-------------------------------|----------|------------------|--|
| Test Requirement: | FCC Part15 C Section 15.209 | | | | | |
| Test Method: | ANSI C63.10:2013 | | | | | |
| Frequency Range: | 9 kHz to 25 GHz | | | | | |
| Measurement Distance: | 3 m | | | | | |
| Antenna Polarization: | Horizontal & Vertical | | | | | |
| Operation mode: | Refer to item 3.1 | | | | | |
| Receiver Setup: | Frequency | Detector | RBW | VBW | Remark | |
| | 9kHz- 150kHz | Quasi-peak | 200Hz | 1kHz | Quasi-peak Value | |
| | 150kHz- 30MHz | Quasi-peak | 9kHz | 30kHz | Quasi-peak Value | |
| | 30MHz-1GHz | Quasi-peak | 120KHz | 300KHz | Quasi-peak Value | |
| | Above 1GHz | Peak | 1MHz | 3MHz | Peak Value | |
| | | Peak | 1MHz | 10Hz | Average Value | |
| Limit: | Frequency | Field Strength (microvolts/meter) | Measurement Distance (meters) | | | |
| | 0.009-0.490 | 2400/F(KHz) | 300 | | | |
| | 0.490-1.705 | 24000/F(KHz) | 30 | | | |
| | 1.705-30 | 30 | 30 | | | |
| | 30-88 | 100 | 3 | | | |
| | 88-216 | 150 | 3 | | | |
| | 216-960 | 200 | 3 | | | |
| | Above 960 | 500 | 3 | | | |
| | Frequency | Field Strength (microvolts/meter) | Measurement Distance (meters) | Detector | | |
| | Above 1GHz | 500 | 3 | Average | | |
| | 5000 | 3 | Peak | | | |
| Test setup: | For radiated emissions below 30MHz | | | | | |
| | <p>Distance = 3m</p> <p>0.8m</p> <p>Turn table</p> <p>1m</p> <p>Ground Plane</p> <p>Computer</p> <p>Pre-Amplifier</p> <p>Receiver</p> | | | | | |
| | 30MHz to 1GHz | | | | | |

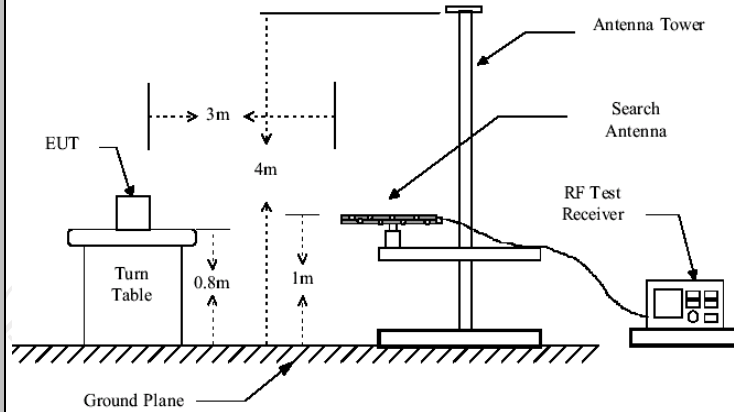

Above 1GHz

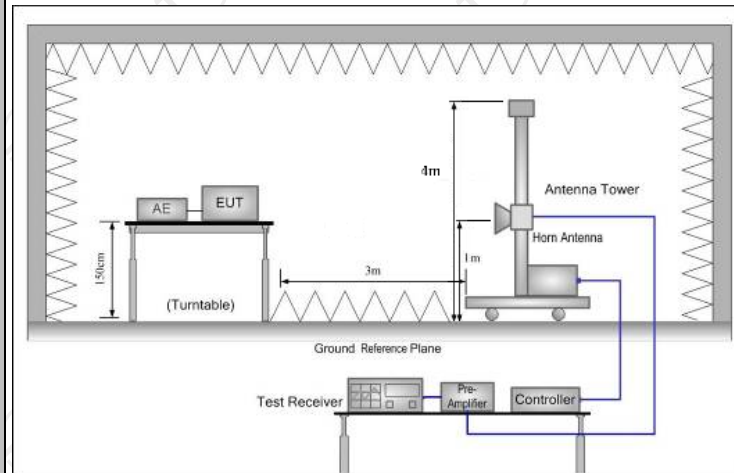

Test Procedure:

1. For the radiated emission test below 1GHz:
The EUT was placed on a turntable with 0.8 meter above ground. The EUT was set 3 meters from the interference receiving antenna, which was mounted on the top of a variable height antenna tower. The EUT was arranged to its worst case and then tune the antenna tower (from 1 m to 4 m) and turntable (from 0 degree to 360 degrees) to find the maximum reading. A pre-amp and a high PASS filter are used for the test in order to get better signal level.
- For the radiated emission test above 1GHz:
Place the measurement antenna on a turntable with 1.5 meter above ground, which is away from each area of the EUT determined to be a source of emissions at the specified measurement distance, while keeping the measurement antenna aimed at the source of emissions at each frequency of significant emissions, with polarization oriented for maximum response. The measurement antenna may have to be higher or lower than the EUT, depending on the radiation pattern of the emission and staying aimed at the emission source for receiving the maximum signal. The final

| | |
|----------------------|---|
| | <p>measurement antenna elevation shall be that which maximizes the emissions. The measurement antenna elevation for maximum emissions shall be restricted to a range of heights of from 1 m to 4 m above the ground or reference ground plane.</p> <p>2. Corrected Reading: Antenna Factor + Cable Loss + Read Level - Preamp Factor = Level</p> <p>3. For measurement below 1GHz, If the emission level of the EUT measured by the peak detector is 3 dB lower than the applicable limit, the peak emission level will be reported. Otherwise, the emission measurement will be repeated using the quasi-peak detector and reported.</p> <p>4. Use the following spectrum analyzer settings:</p> <p>(1) Span shall wide enough to fully capture the emission being measured;</p> <p>(2) Set RBW=120 kHz for $f < 1$ GHz; VBW \geq RBW; Sweep = auto; Detector function = peak; Trace = max hold;</p> <p>(3) Set RBW = 1 MHz, VBW= 3MHz for $f > 1$ GHz for peak measurement.</p> <p>For average measurement: VBW = 10 Hz, when duty cycle is no less than 98 percent. VBW $\geq 1/T$, when duty cycle is less than 98 percent where T is the minimum transmission duration over which the transmitter is on and is transmitting at its maximum power control level for the tested mode of operation.</p> |
| Test mode: | Refer to section 3.1 for details |
| Test results: | PASS |

5.7.2. Test Instruments

| Radiated Emission Test Site (966) | | | | |
|-----------------------------------|--------------------|---------------|----------------|-----------------|
| Name of Equipment | Manufacturer | Model | Serial Number | Calibration Due |
| EMI Test Receiver | R&S | ESIB7 | 100197 | Jun. 29, 2024 |
| Spectrum Analyzer | R&S | FSQ40 | 200061 | Jun. 29, 2024 |
| Pre-amplifier | SKET | LNPA_0118G-45 | SK2021012102 | Feb. 01, 2025 |
| Pre-amplifier | SKET | LNPA_1840G-50 | SK202109203500 | Feb. 01, 2025 |
| Pre-amplifier | HP | 8447D | 2727A05017 | Jun. 27, 2024 |
| Loop antenna | Schwarzbeck | FMZB1519B | 00191 | Jul. 02, 2024 |
| Broadband Antenna | Schwarzbeck | VULB9163 | 340 | Jul. 01, 2024 |
| Horn Antenna | Schwarzbeck | BBHA 9120D | 631 | Jul. 01, 2024 |
| Horn Antenna | Schwarzbeck | BBHA 9170 | 00956 | Feb. 01, 2025 |
| Antenna Mast | Keleto | RE-AM | / | / |
| Coaxial cable | SKET | RC-18G-N-M | / | Feb. 01, 2025 |
| Coaxial cable | SKET | RC_40G-K-M | / | Feb. 01, 2025 |
| EMI Test Software | Shurple Technology | EZ-EMC | / | / |

5.7.3. Test Data

Please refer to following diagram for individual
Below 1GHz

Horizontal:

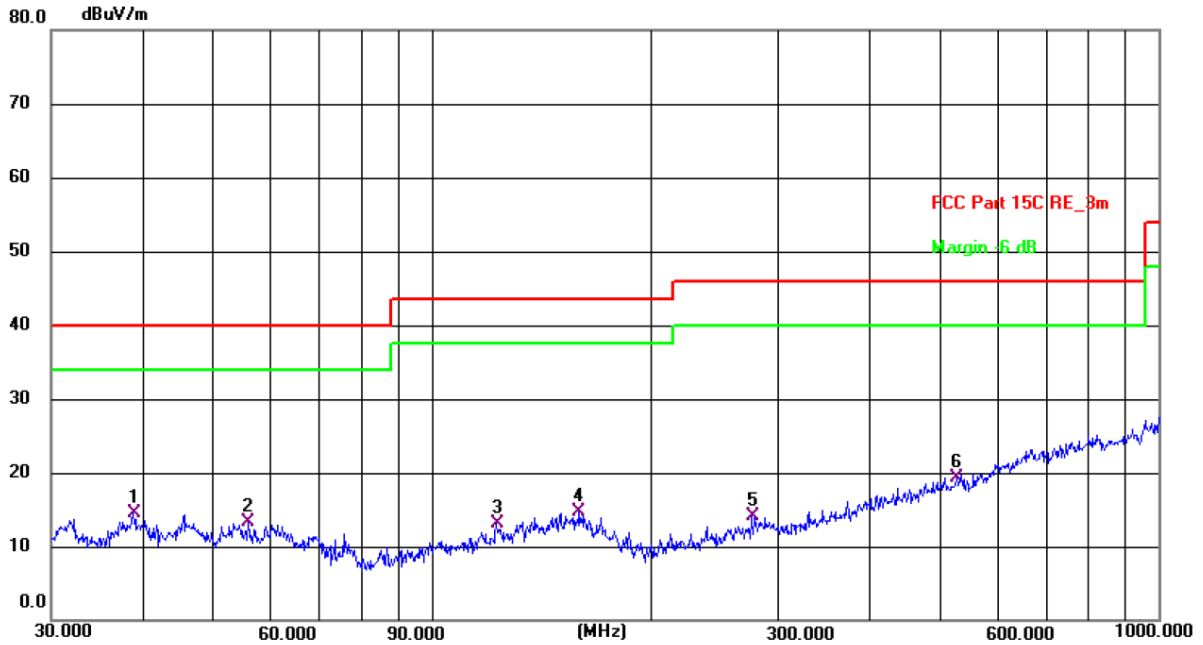

Site 3m Anechoic Chamber

Polarization: **Horizontal**

Temperature: 24.1(C)

Humidity: 53 %

Limit: FCC Part 15C RE_3m

Power: DC 3.7 V

| No. | Frequency (MHz) | Reading (dBuV) | Factor (dB/m) | Level (dBuV/m) | Limit (dBuV/m) | Margin (dB) | Detector | P/F | Remark |
|-----|-----------------|----------------|---------------|----------------|----------------|-------------|----------|-----|--------|
| 1 * | 38.8878 | 32.80 | -18.33 | 14.47 | 40.00 | -25.53 | QP | P | |
| 2 | 56.0007 | 31.80 | -18.47 | 13.33 | 40.00 | -26.67 | QP | P | |
| 3 | 122.8340 | 31.83 | -18.76 | 13.07 | 43.50 | -30.43 | QP | P | |
| 4 | 159.7844 | 31.43 | -16.78 | 14.65 | 43.50 | -28.85 | QP | P | |
| 5 | 276.1235 | 31.54 | -17.40 | 14.14 | 46.00 | -31.86 | QP | P | |
| 6 | 528.2458 | 30.90 | -11.63 | 19.27 | 46.00 | -26.73 | QP | P | |

Vertical:

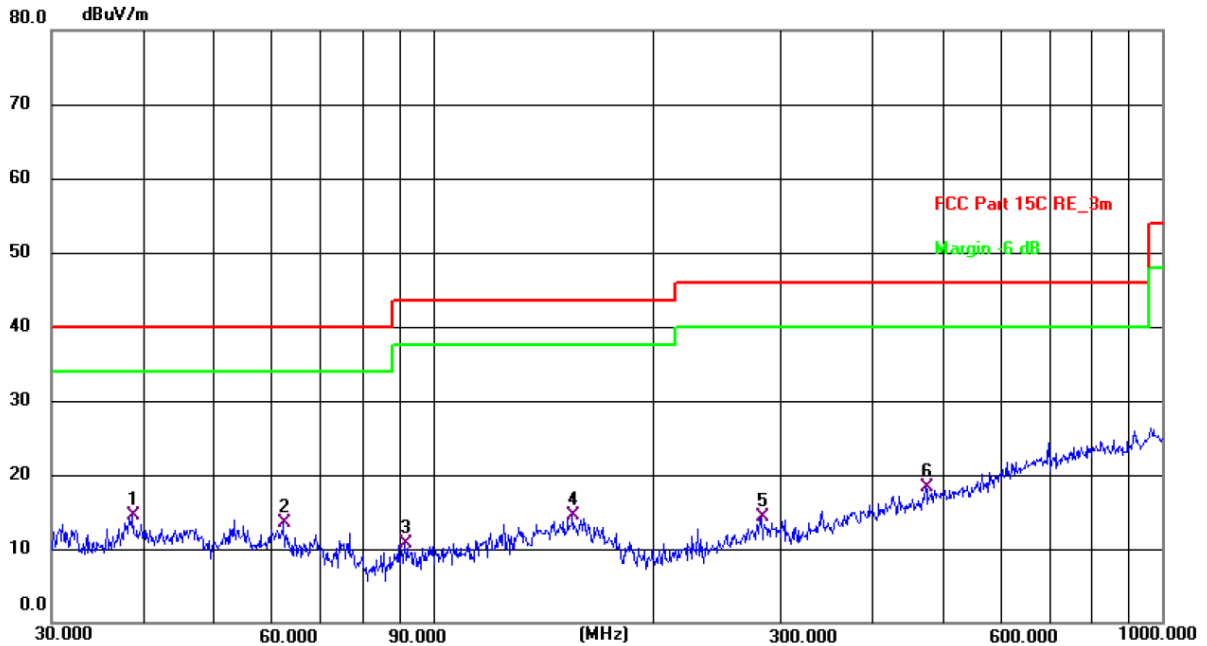

Site: 3m Anechoic Chamber Polarization: **Vertical** Temperature: 24.1(C) Humidity: 53 %

Limit: FCC Part 15C RE_3m Power: DC 3.7 V

| No. | Frequency (MHz) | Reading (dBuV) | Factor (dB/m) | Level (dBuV/m) | Limit (dBuV/m) | Margin (dB) | Detector | P/F | Remark |
|-----|-----------------|----------------|---------------|----------------|----------------|-------------|----------|-----|--------|
| 1 * | 38.7518 | 32.92 | -18.37 | 14.55 | 40.00 | -25.45 | QP | P | |
| 2 | 62.4314 | 32.35 | -18.83 | 13.52 | 40.00 | -26.48 | QP | P | |
| 3 | 91.4949 | 32.83 | -22.20 | 10.63 | 43.50 | -32.87 | QP | P | |
| 4 | 155.3644 | 31.13 | -16.56 | 14.57 | 43.50 | -28.93 | QP | P | |
| 5 | 281.9946 | 31.51 | -17.22 | 14.29 | 46.00 | -31.71 | QP | P | |
| 6 | 473.8347 | 31.07 | -12.67 | 18.40 | 46.00 | -27.60 | QP | P | |

- Note:**
- The low frequency, which started from 9KHz~30MHz, was pre-scanned and the result which was 20dB lower than the limit line per 15.31(o) was not reported
 - Speed for 1M and 2M modulations of EUT have been tested, but the test data only show the worst case in this report, and we found the worst case is 2M speed modulation. Measurements were conducted in all three channels (high, middle, low), and the worst case Mode (Highest channel) was submitted only.
Both AC mode and Internal battery mode have been tested, only the Internal battery mode which is worse reported.
 - Freq. = Emission frequency in MHz
 Measurement (dBuV/m) = Reading level (dBuV) + Corr. Factor (dB)
 Correction Factor = Antenna Factor + Cable loss – Pre-amplifier
 Limit (dBuV/m) = Limit stated in standard
 Margin (dB) = Measurement (dBuV/m) – Limits (dBuV/m)
 * is meaning the worst frequency has been tested in the test frequency range

Test Result of Radiated Spurious at Band edges

Lowest channel 2402:

Horizontal:

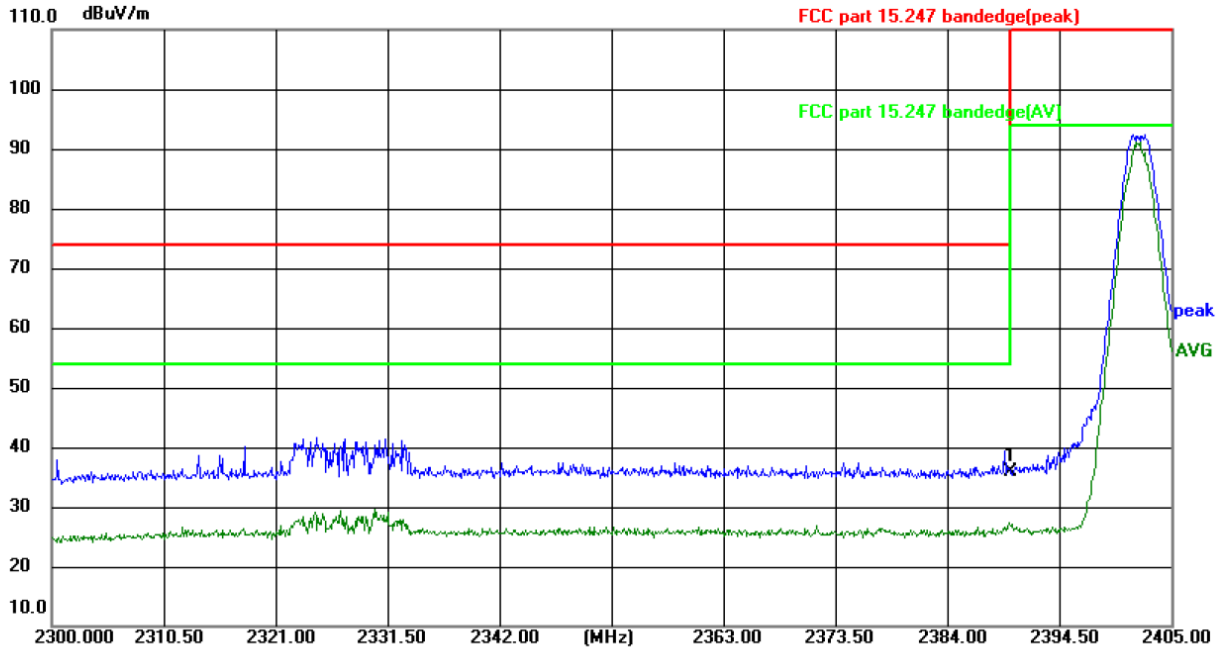

Site: 3m Anechoic Chamber Polarization: **Horizontal** Temperature: 23.3(°C) Humidity: 52 %

Limit: FCC part 15.247 bandedge(peak) Power:DC 3.7 V

| No. | Frequency (MHz) | Reading (dBuV) | Factor (dB/m) | Level (dBuV/m) | Limit (dBuV/m) | Margin (dB) | Detector | P/F | Remark |
|-----|-----------------|----------------|---------------|----------------|----------------|-------------|----------|-----|--------|
| 1 * | 2390.000 | 51.64 | -15.86 | 35.78 | 74.00 | -38.22 | peak | P | |

Vertical:

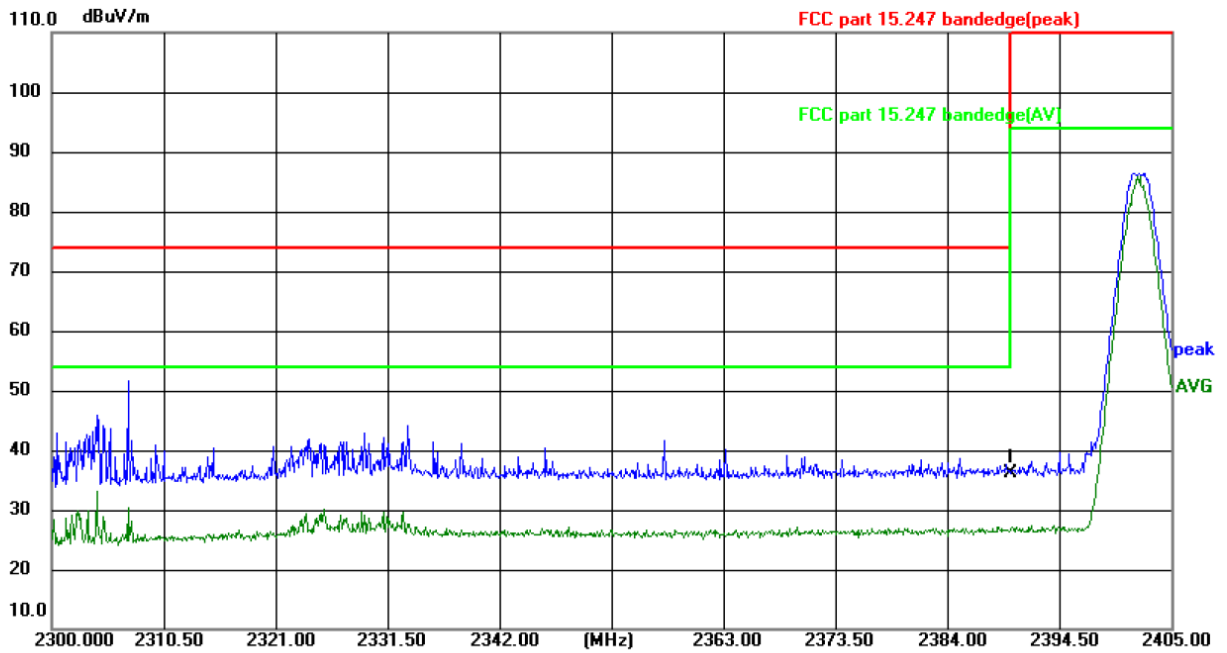

Site: 3m Anechoic Chamber Polarization: **Vertical** Temperature: 23.3(°C) Humidity: 52 %

Limit: FCC part 15.247 bandedge(peak) Power:DC 3.7 V

| No. | Frequency (MHz) | Reading (dBuV) | Factor (dB/m) | Level (dBuV/m) | Limit (dBuV/m) | Margin (dB) | Detector | P/F | Remark |
|-----|-----------------|----------------|---------------|----------------|----------------|-------------|----------|-----|--------|
| 1 * | 2390.000 | 52.05 | -15.86 | 36.19 | 74.00 | -37.81 | peak | P | |

Highest channel 2480:

Horizontal:

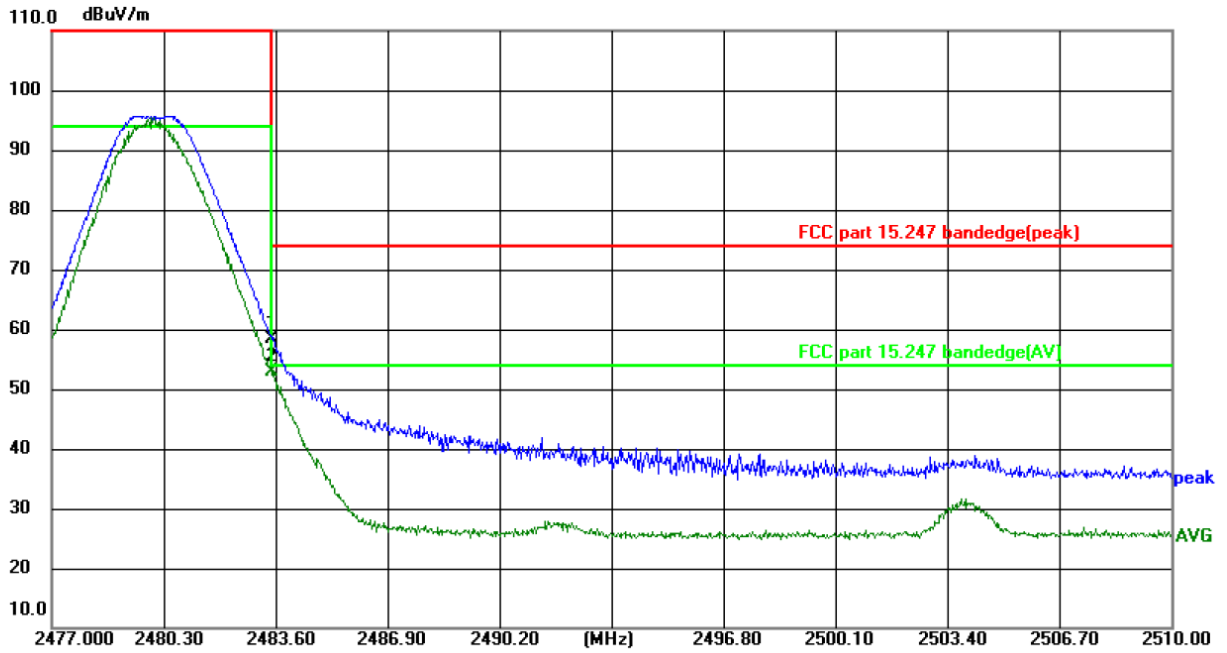

Site: 3m Anechoic Chamber

Polarization: **Horizontal**

Temperature: 23.3(°C)

Humidity: 52 %

Limit: FCC part 15.247 bandedge(peak)

Power:DC 3.7 V

| No. | Frequency (MHz) | Reading (dBuV) | Factor (dB/m) | Level (dBuV/m) | Limit (dBuV/m) | Margin (dB) | Detector | P/F | Remark |
|-----|-----------------|----------------|---------------|----------------|----------------|-------------|----------|-----|--------|
| 1 | 2483.500 | 74.20 | -15.87 | 58.33 | 74.00 | -15.67 | peak | P | |
| 2 * | 2483.500 | 68.73 | -15.87 | 52.86 | 54.00 | -1.14 | AVG | P | |

Vertical:

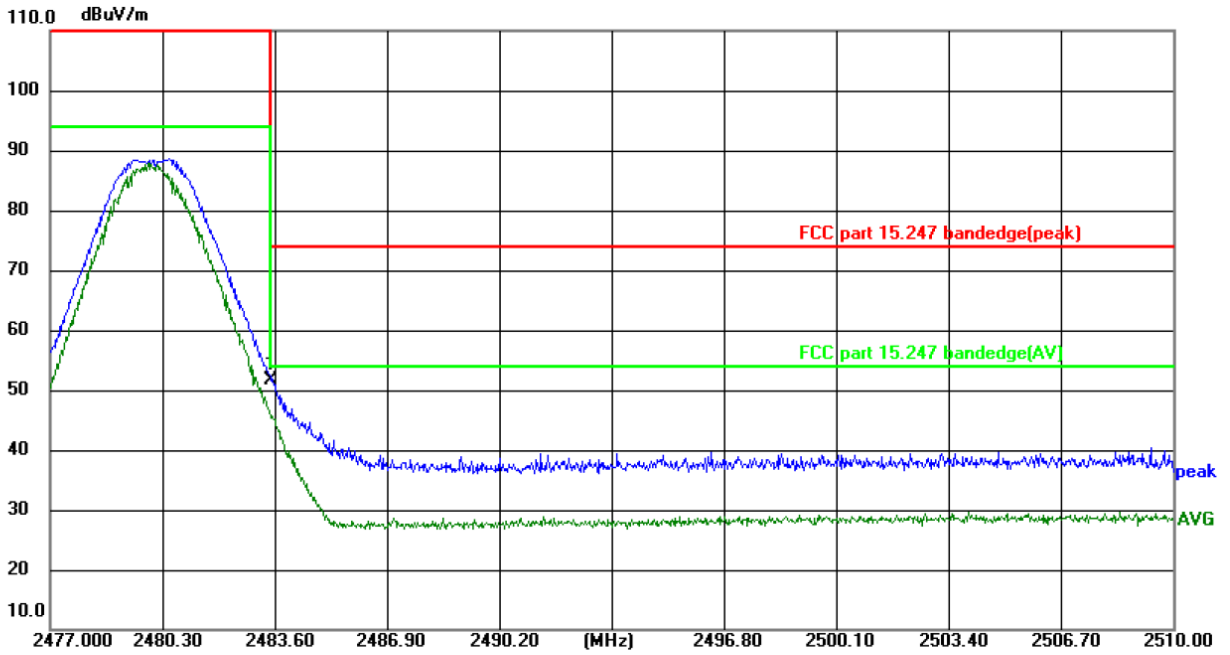

Site: 3m Anechoic Chamber Polarization: **Vertical** Temperature: 23.3(°C) Humidity: 52 %

Limit: FCC part 15.247 bandedge(peak) Power:DC 3.7 V

| No. | Frequency (MHz) | Reading (dBuV) | Factor (dB/m) | Level (dBuV/m) | Limit (dBuV/m) | Margin (dB) | Detector | P/F | Remark |
|-----|-----------------|----------------|---------------|----------------|----------------|-------------|----------|-----|--------|
| 1 * | 2483.500 | 67.44 | -15.87 | 51.57 | 74.00 | -22.43 | peak | P | |

Note: Speed for 1M and 2M modulations of EUT have been tested, but the test data only show the worst case in this report, and we found the worst case is 2M speed modulation.



Above 1GHz

| Low channel: 2402 MHz | | | | | | | | | |
|-----------------------|---------------|---------------------------|-------------------------|--------------------------|---------------------|-------------------|---------------------------|-------------------------|-------------|
| Frequency (MHz) | Ant. Pol. H/V | Peak reading (dB μ V) | AV reading (dB μ V) | Correction Factor (dB/m) | Emission Level | | Peak limit (dB μ V/m) | AV limit (dB μ V/m) | Margin (dB) |
| | | | | | Peak (dB μ V/m) | AV (dB μ V/m) | | | |
| 4804 | H | 45.10 | --- | 0.66 | 45.76 | --- | 74 | 54 | -8.24 |
| 7206 | H | 34.69 | --- | 9.50 | 44.19 | --- | 74 | 54 | -9.81 |
| --- | H | --- | --- | --- | --- | --- | --- | --- | --- |
| 4804 | V | 45.21 | --- | 0.66 | 45.87 | --- | 74 | 54 | -8.13 |
| 7206 | V | 34.09 | --- | 9.50 | 43.59 | --- | 74 | 54 | -10.41 |
| --- | V | --- | --- | --- | --- | --- | --- | --- | --- |

| Middle channel: 2440 MHz | | | | | | | | | |
|--------------------------|---------------|---------------------------|-------------------------|--------------------------|---------------------|-------------------|---------------------------|-------------------------|-------------|
| Frequency (MHz) | Ant. Pol. H/V | Peak reading (dB μ V) | AV reading (dB μ V) | Correction Factor (dB/m) | Emission Level | | Peak limit (dB μ V/m) | AV limit (dB μ V/m) | Margin (dB) |
| | | | | | Peak (dB μ V/m) | AV (dB μ V/m) | | | |
| 4880 | H | 44.02 | --- | 0.99 | 45.01 | --- | 74 | 54 | -8.99 |
| 7320 | H | 35.68 | --- | 9.87 | 45.55 | --- | 74 | 54 | -8.45 |
| --- | H | --- | --- | --- | --- | --- | --- | --- | --- |
| 4880 | V | 45.40 | --- | 0.99 | 46.39 | --- | 74 | 54 | -7.61 |
| 7320 | V | 35.81 | --- | 9.87 | 45.68 | --- | 74 | 54 | -8.32 |
| --- | V | --- | --- | --- | --- | --- | --- | --- | --- |

| High channel: 2480 MHz | | | | | | | | | |
|------------------------|---------------|---------------------------|-------------------------|--------------------------|---------------------|-------------------|---------------------------|-------------------------|-------------|
| Frequency (MHz) | Ant. Pol. H/V | Peak reading (dB μ V) | AV reading (dB μ V) | Correction Factor (dB/m) | Emission Level | | Peak limit (dB μ V/m) | AV limit (dB μ V/m) | Margin (dB) |
| | | | | | Peak (dB μ V/m) | AV (dB μ V/m) | | | |
| 4960 | H | 45.49 | --- | 1.33 | 46.82 | --- | 74 | 54 | -7.18 |
| 7440 | H | 36.92 | --- | 10.22 | 47.14 | --- | 74 | 54 | -6.86 |
| --- | H | --- | --- | --- | --- | --- | --- | --- | --- |
| 4960 | V | 45.13 | --- | 1.33 | 46.46 | --- | 74 | 54 | -7.54 |
| 7440 | V | 35.48 | --- | 10.22 | 45.70 | --- | 74 | 54 | -8.30 |
| --- | V | --- | --- | --- | --- | --- | --- | --- | --- |

Note:

1. Emission Level=Peak Reading + Correction Factor; Correction Factor= Antenna Factor + Cable loss – Pre-amplifier
2. Margin (dB) = Emission Level (Peak) (dB μ V/m)-Average limit (dB μ V/m)
3. The emission levels of other frequencies are very lower than the limit and not show in test report.
4. Measurements were conducted from 1 GHz to the 10th harmonic of highest fundamental frequency.
5. Data of measurement shown “---“in the above table mean that the reading of emissions is attenuated more than 20 dB below the limits or the field strength is too small to be measured.
6. Speed for 1M and 2M modulations of EUT have been tested, but the test data only show the worst case in this report, and we found the worst case is 2M speed modulation.
7. All the restriction bands are compliance with the limit of 15.209.

Appendix A: Test Result of Conducted Test**Duty Cycle**

| Condition | Mode | Frequency (MHz) | Duty Cycle (%) | Correction Factor (dB) | 1/T (kHz) |
|-----------|--------|-----------------|----------------|------------------------|-----------|
| NVNT | BLE 1M | 2402 | 68.28 | 1.66 | 2.38 |
| NVNT | BLE 1M | 2440 | 68.70 | 1.63 | 2.38 |
| NVNT | BLE 1M | 2480 | 68.01 | 1.67 | 2.44 |
| NVNT | BLE 2M | 2402 | 39.21 | 4.07 | 4.35 |
| NVNT | BLE 2M | 2440 | 39.95 | 3.99 | 4.17 |
| NVNT | BLE 2M | 2480 | 40.00 | 3.98 | 4.17 |

Test Graphs Duty Cycle NVNT BLE 1M 2402MHz

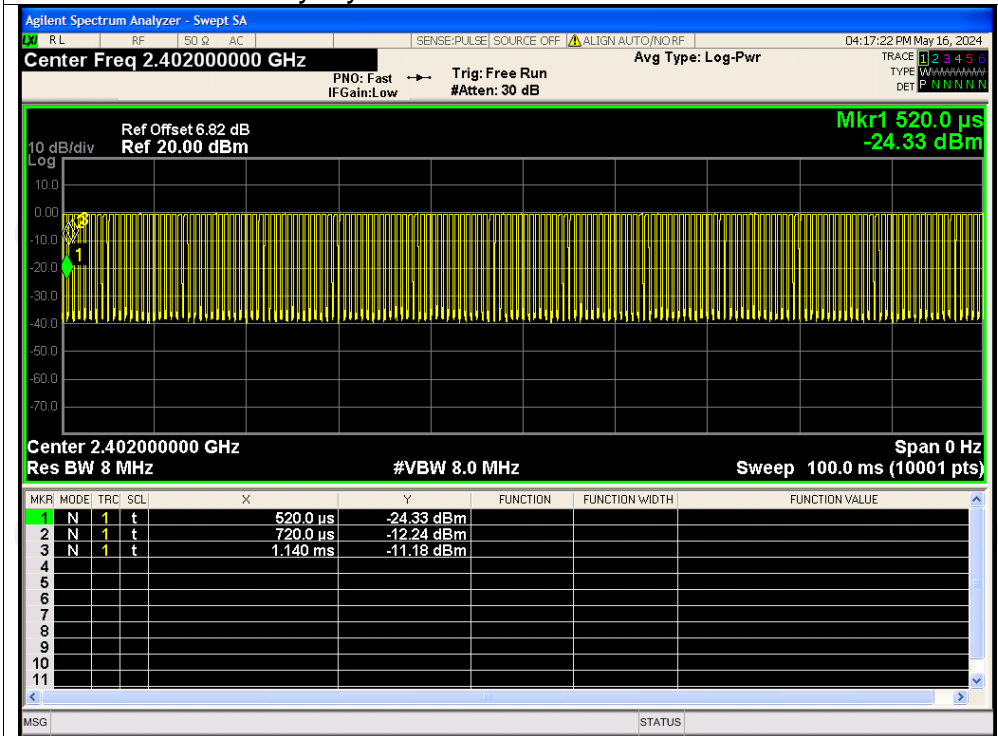

Duty Cycle NVNT BLE 1M 2440MHz

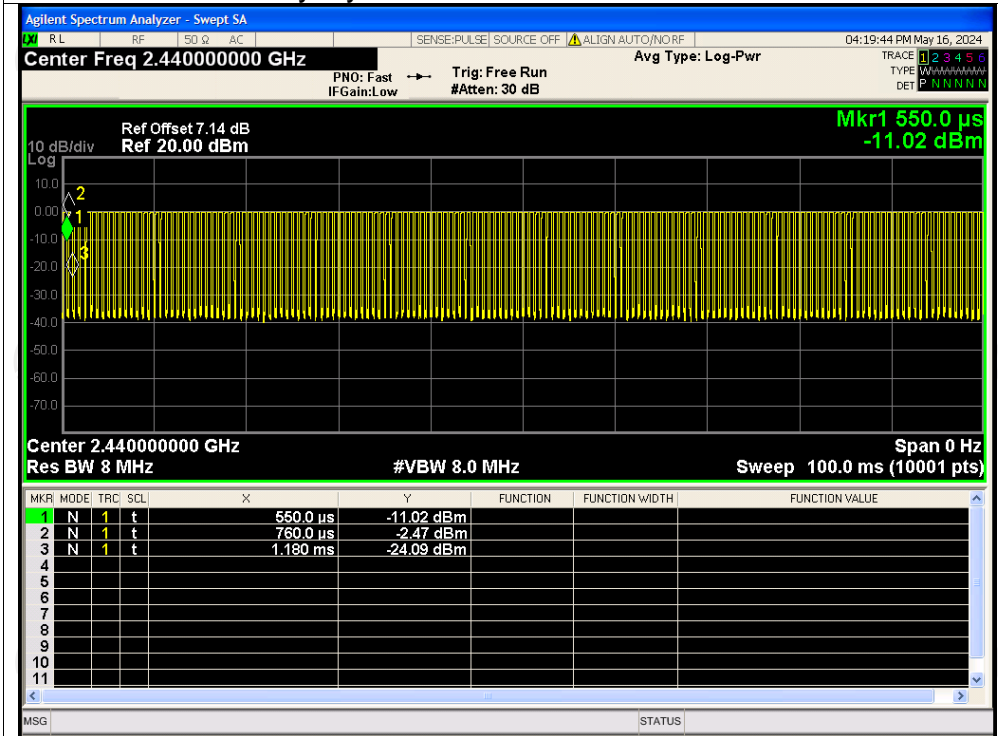

Duty Cycle NVNT BLE 1M 2480MHz

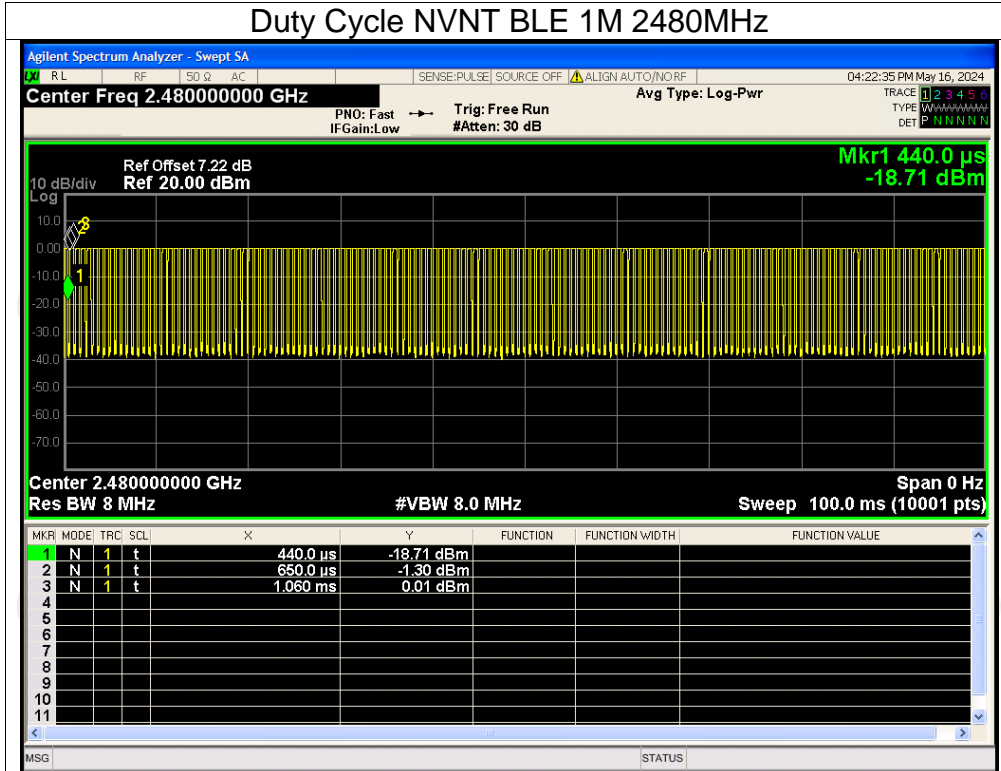

Duty Cycle NVNT BLE 2M 2402MHz

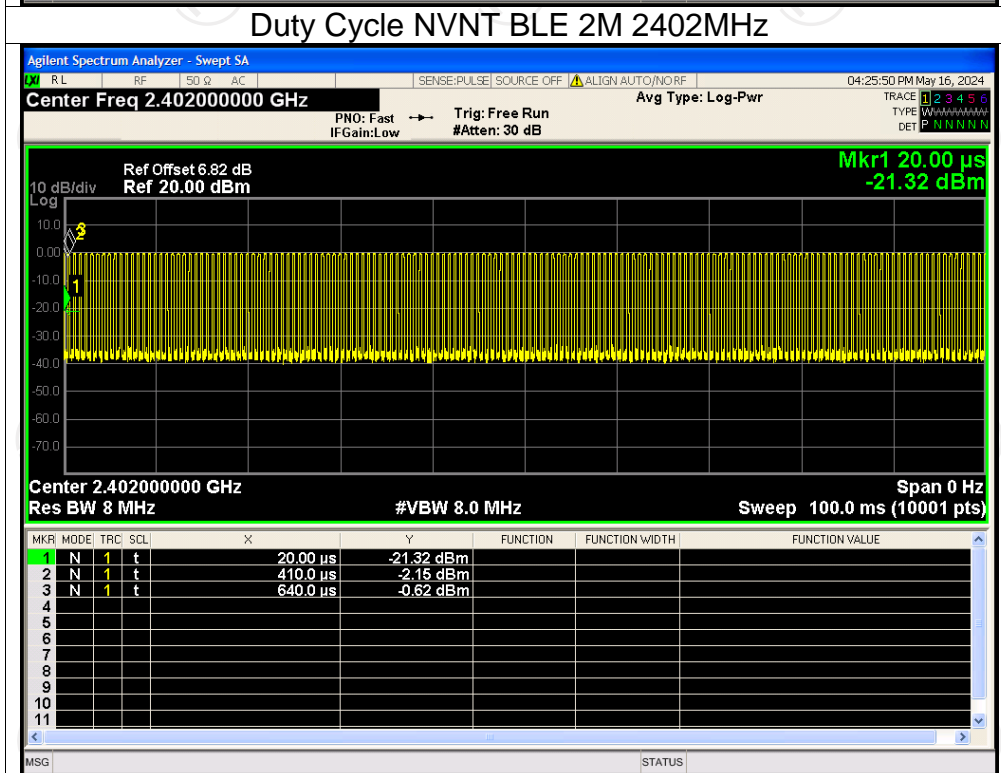

Duty Cycle NVNT BLE 2M 2440MHz

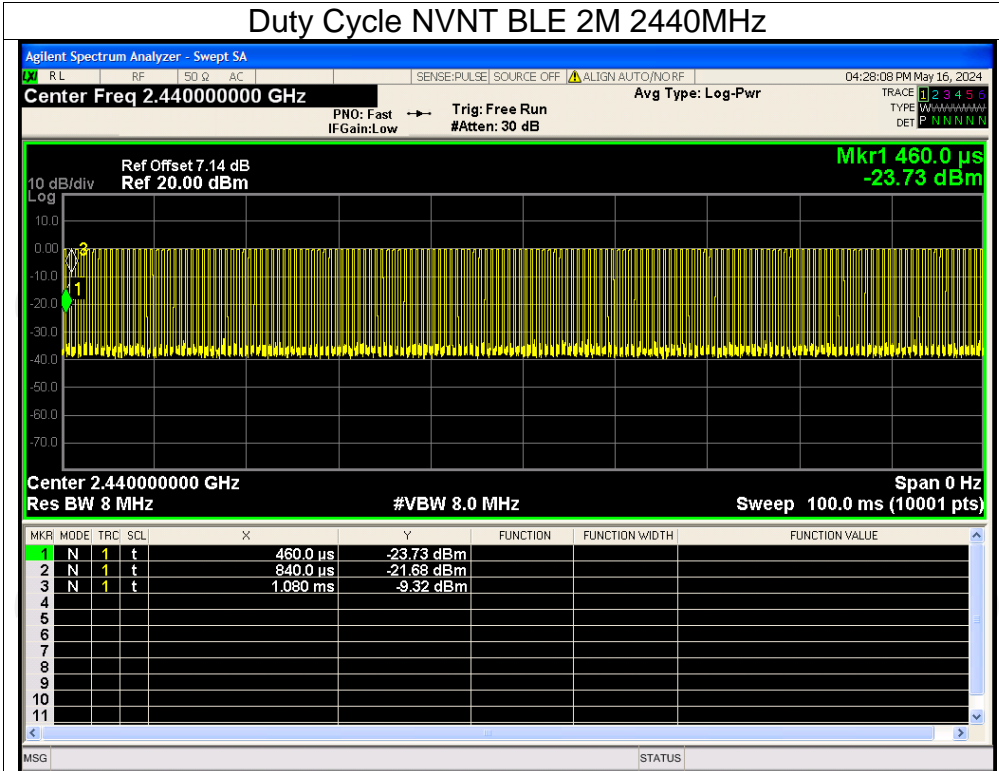

Duty Cycle NVNT BLE 2M 2480MHz

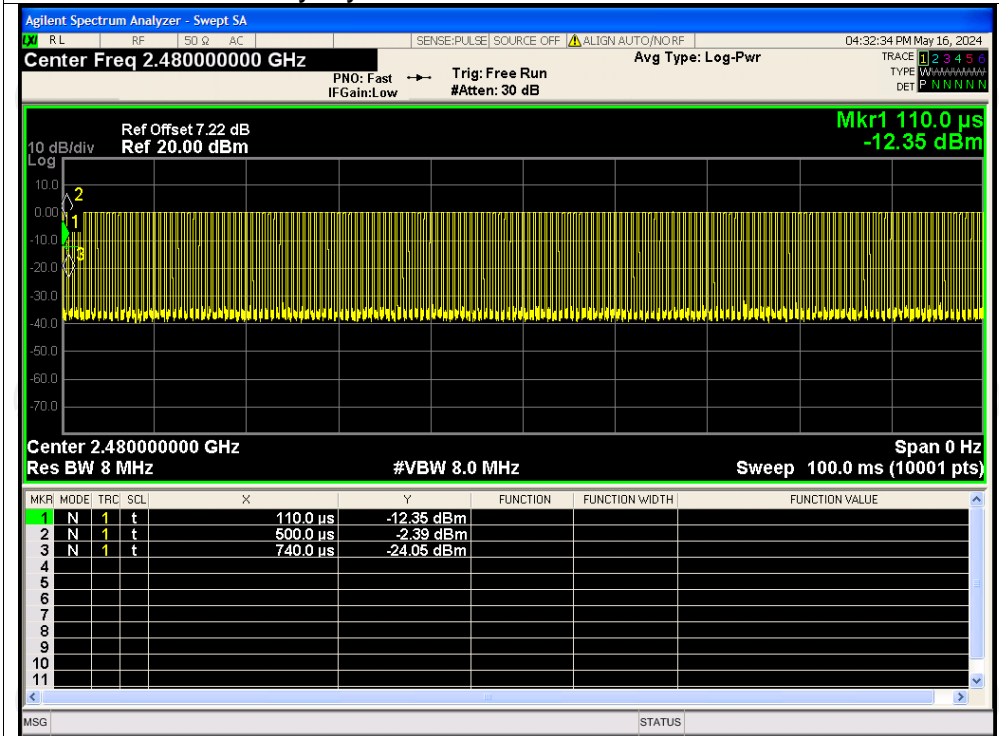

Maximum Conducted Output Power

| Condition | Mode | Frequency (MHz) | Conducted Power (dBm) | Limit (dBm) | Verdict |
|-----------|--------|-----------------|-----------------------|-------------|---------|
| NVNT | BLE 1M | 2402 | -0.45 | 30 | Pass |
| NVNT | BLE 1M | 2440 | -0.23 | 30 | Pass |
| NVNT | BLE 1M | 2480 | 0.09 | 30 | Pass |
| NVNT | BLE 2M | 2402 | -0.49 | 30 | Pass |
| NVNT | BLE 2M | 2440 | -0.22 | 30 | Pass |
| NVNT | BLE 2M | 2480 | 0.14 | 30 | Pass |

Test Graphs
Power NVNT BLE 1M 2402MHz

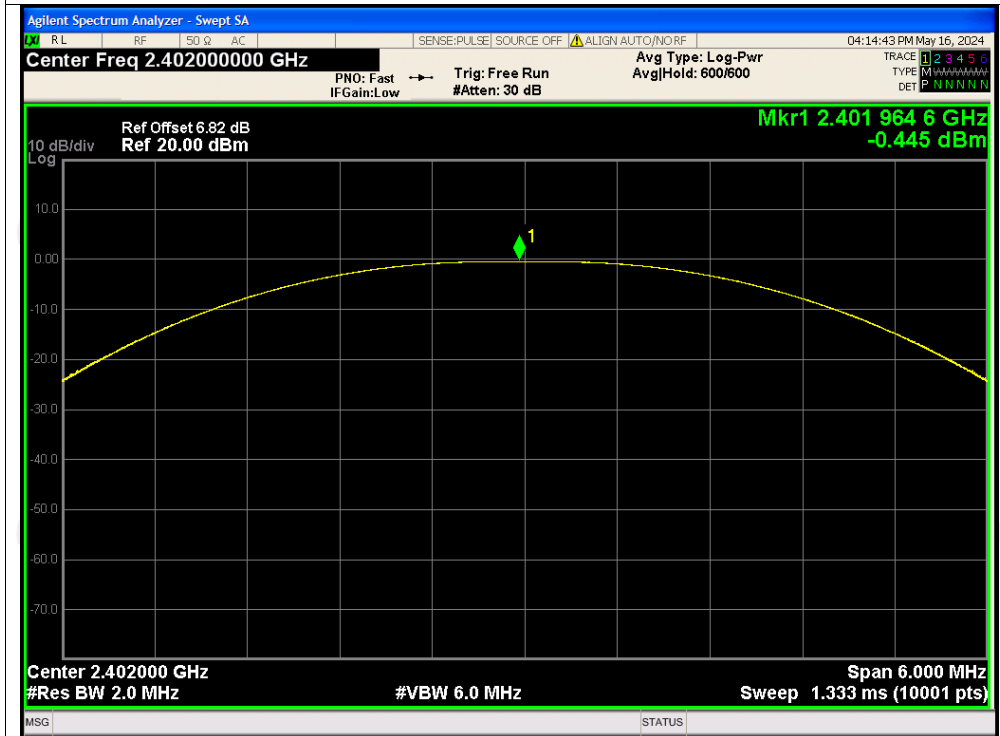

Power NVNT BLE 1M 2440MHz

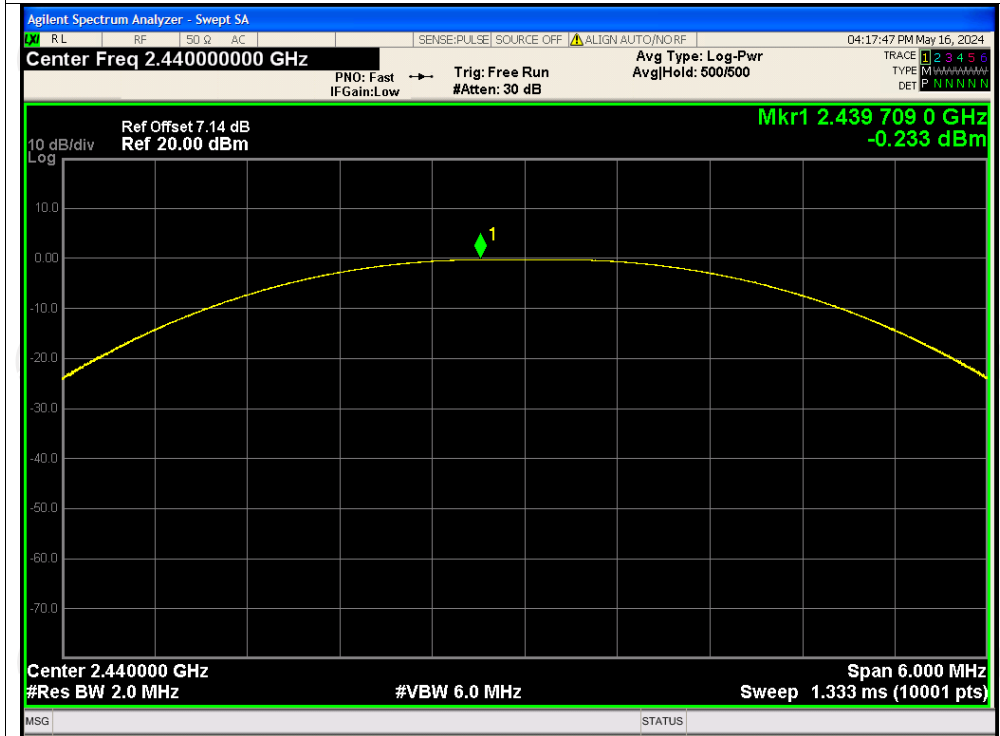

Power NVNT BLE 1M 2480MHz

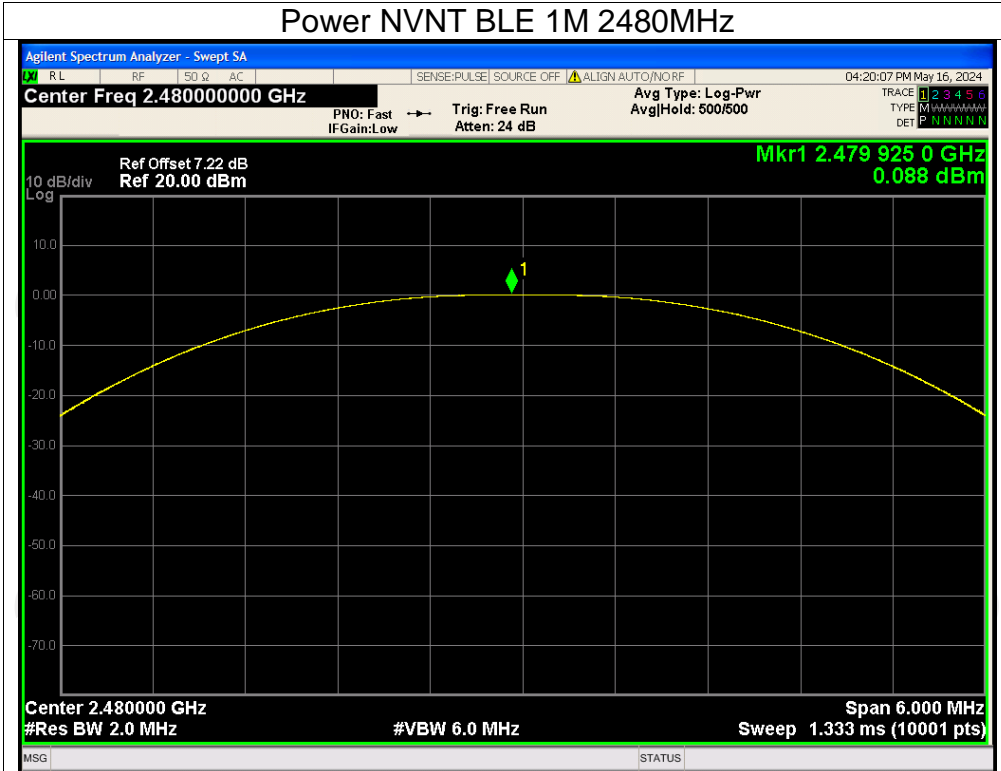

Power NVNT BLE 2M 2402MHz

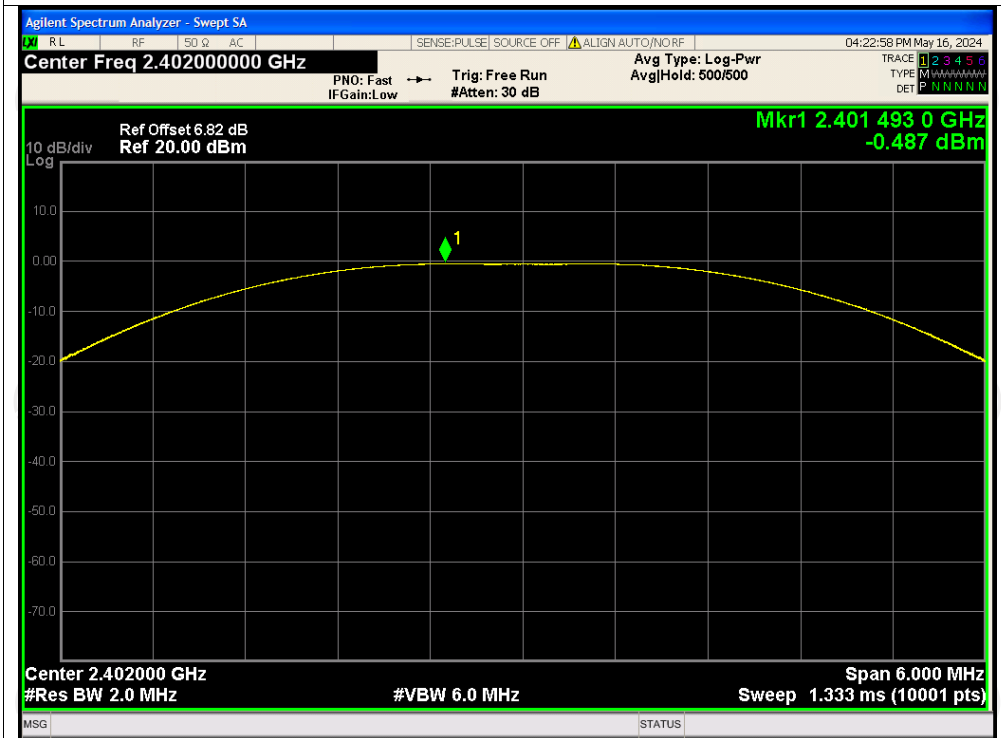

Power NVNT BLE 2M 2440MHz

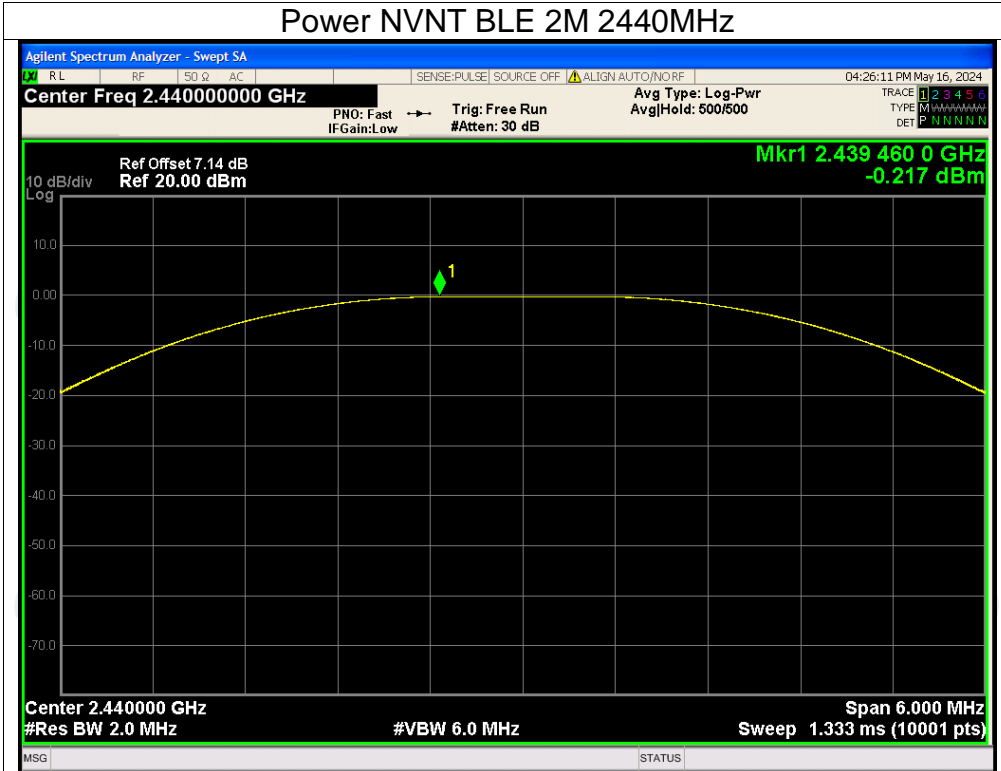

Power NVNT BLE 2M 2480MHz



-6dB Bandwidth

| Condition | Mode | Frequency (MHz) | -6 dB Bandwidth (MHz) | Limit -6 dB Bandwidth (MHz) | Verdict |
|-----------|--------|-----------------|-----------------------|-----------------------------|---------|
| NVNT | BLE 1M | 2402 | 0.656 | 0.5 | Pass |
| NVNT | BLE 1M | 2440 | 0.658 | 0.5 | Pass |
| NVNT | BLE 1M | 2480 | 0.656 | 0.5 | Pass |
| NVNT | BLE 2M | 2402 | 1.102 | 0.5 | Pass |
| NVNT | BLE 2M | 2440 | 1.099 | 0.5 | Pass |
| NVNT | BLE 2M | 2480 | 1.105 | 0.5 | Pass |



Test Graphs

-6dB Bandwidth NVNT BLE 1M 2402MHz

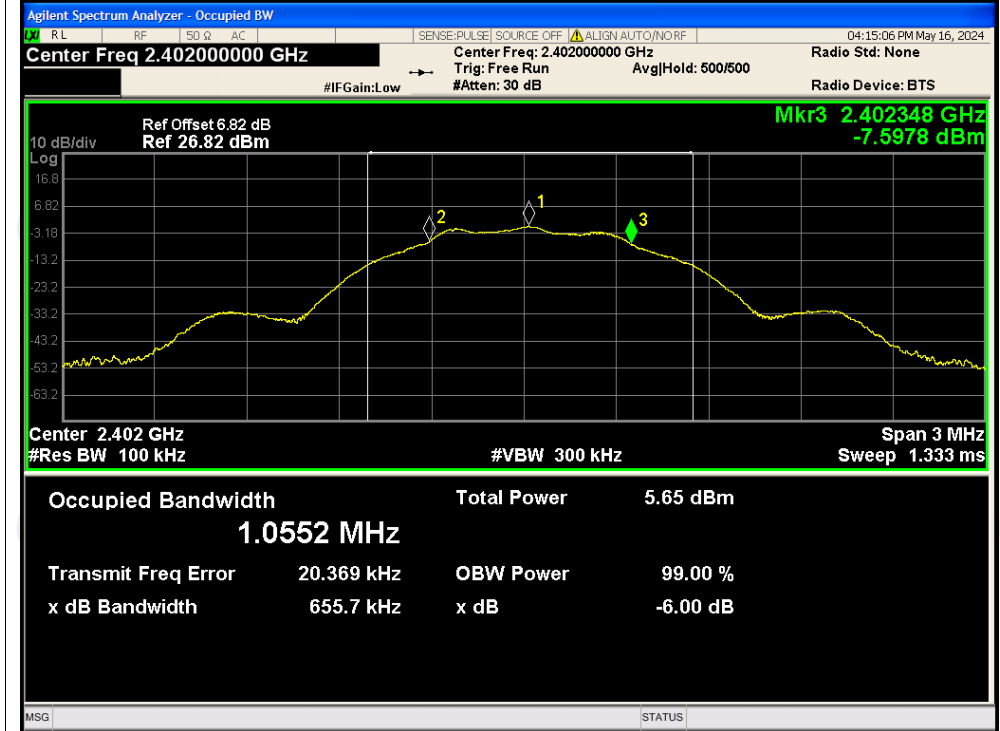

-6dB Bandwidth NVNT BLE 1M 2440MHz

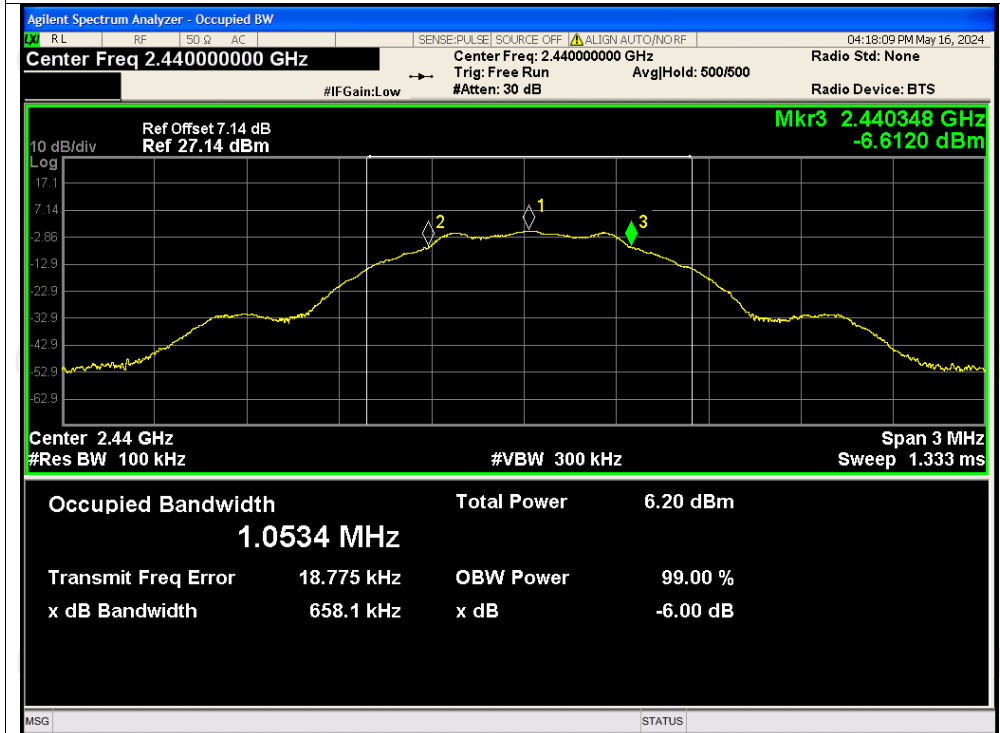

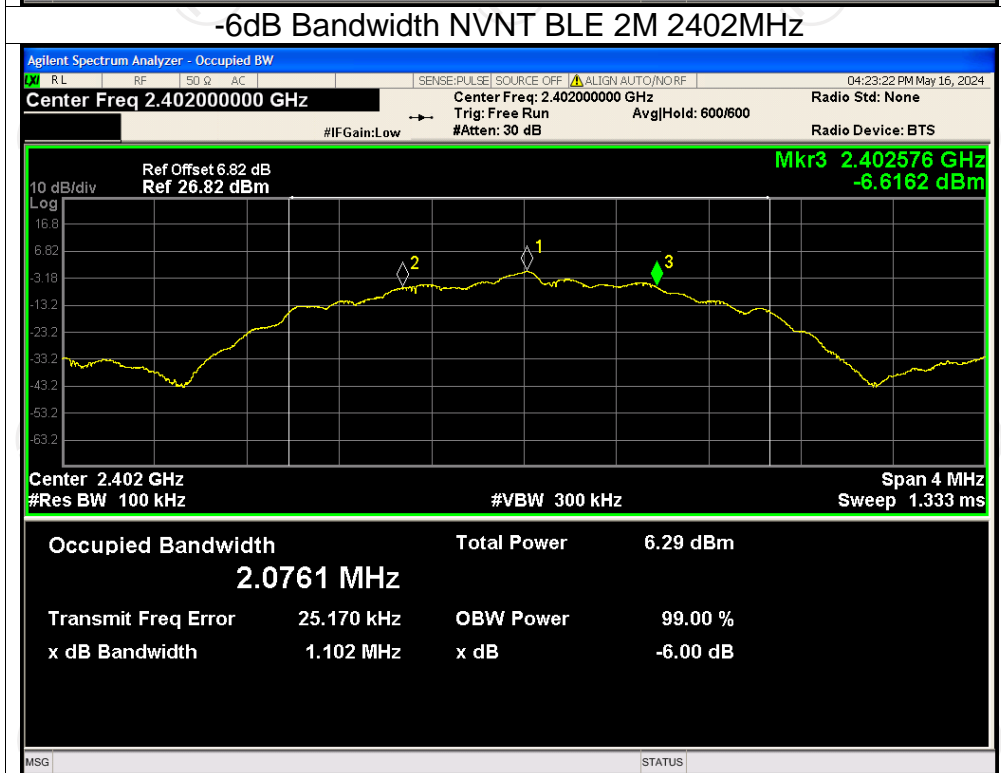
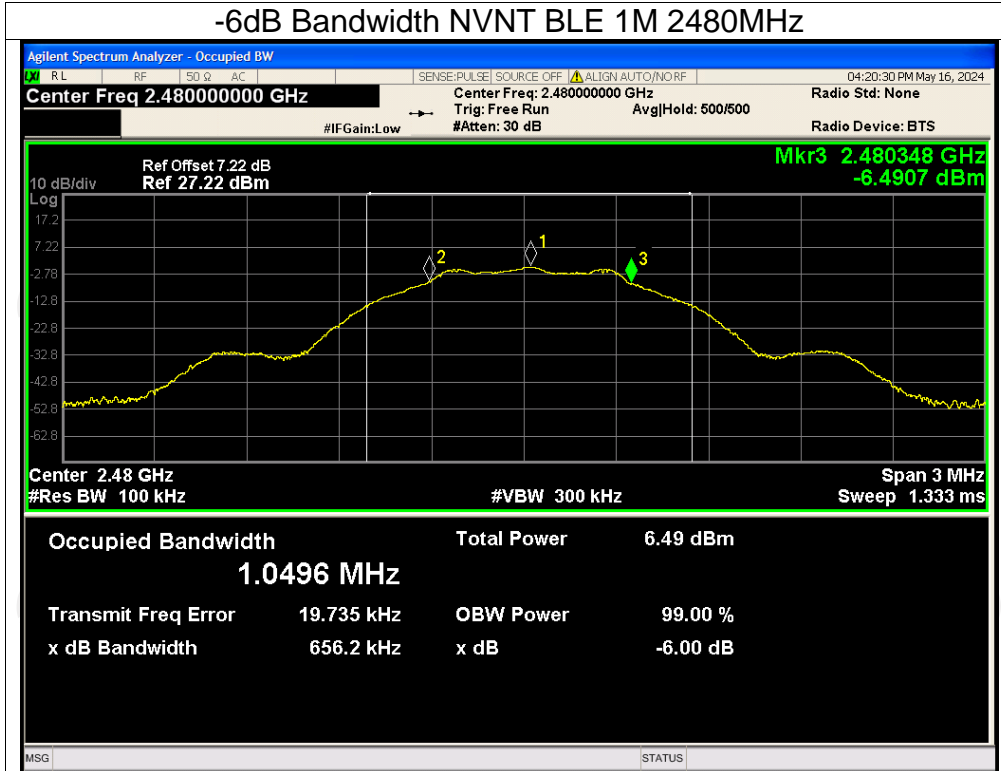

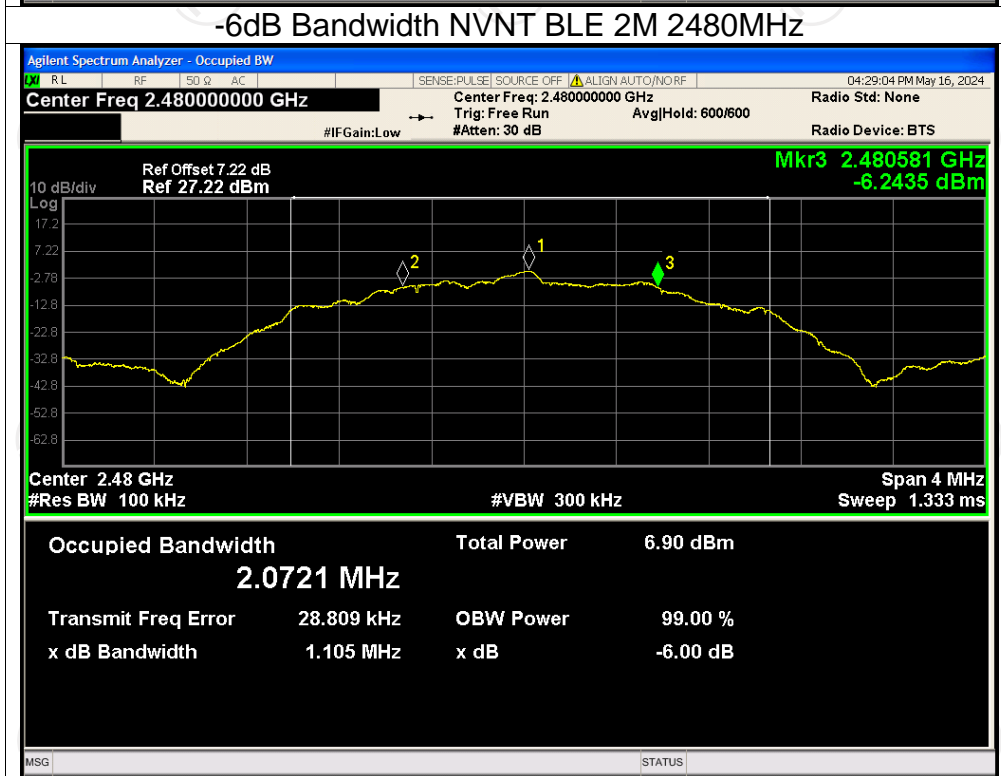
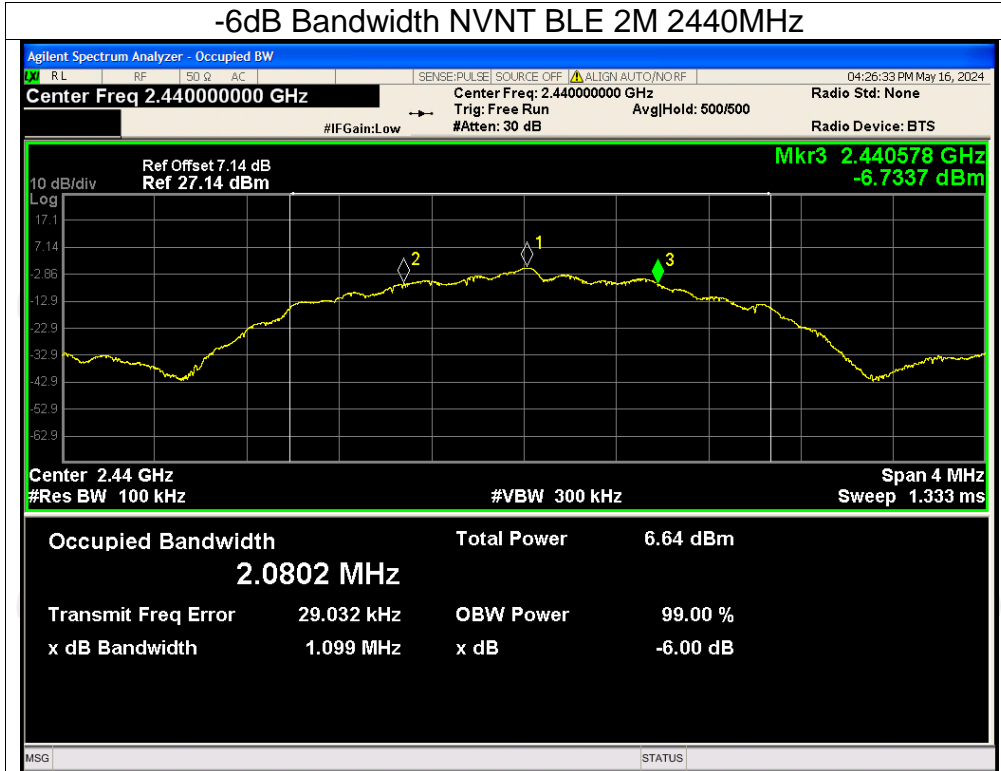

Maximum Power Spectral Density Level

| Condition | Mode | Frequency (MHz) | Conducted PSD (dBm/3KHz) | Limit (dBm/3KHz) | Verdict |
|-----------|--------|-----------------|--------------------------|------------------|---------|
| NVNT | BLE 1M | 2402 | -14.46 | 8 | Pass |
| NVNT | BLE 1M | 2440 | -14.10 | 8 | Pass |
| NVNT | BLE 1M | 2480 | -14.40 | 8 | Pass |
| NVNT | BLE 2M | 2402 | -18.05 | 8 | Pass |
| NVNT | BLE 2M | 2440 | -16.53 | 8 | Pass |
| NVNT | BLE 2M | 2480 | -16.26 | 8 | Pass |

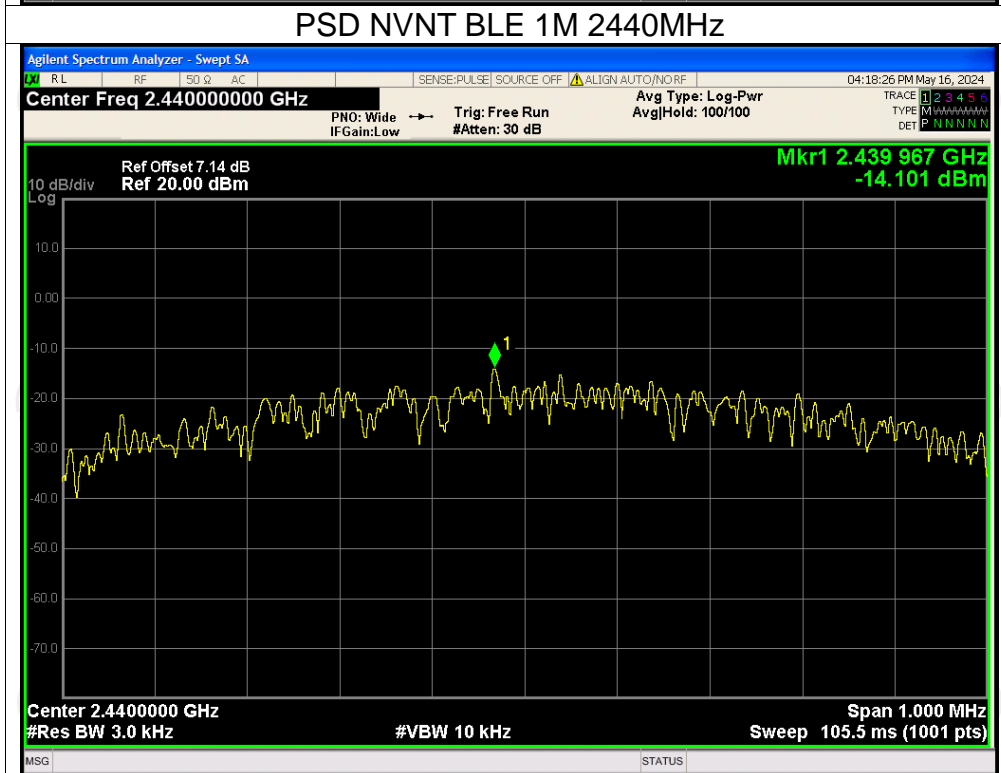
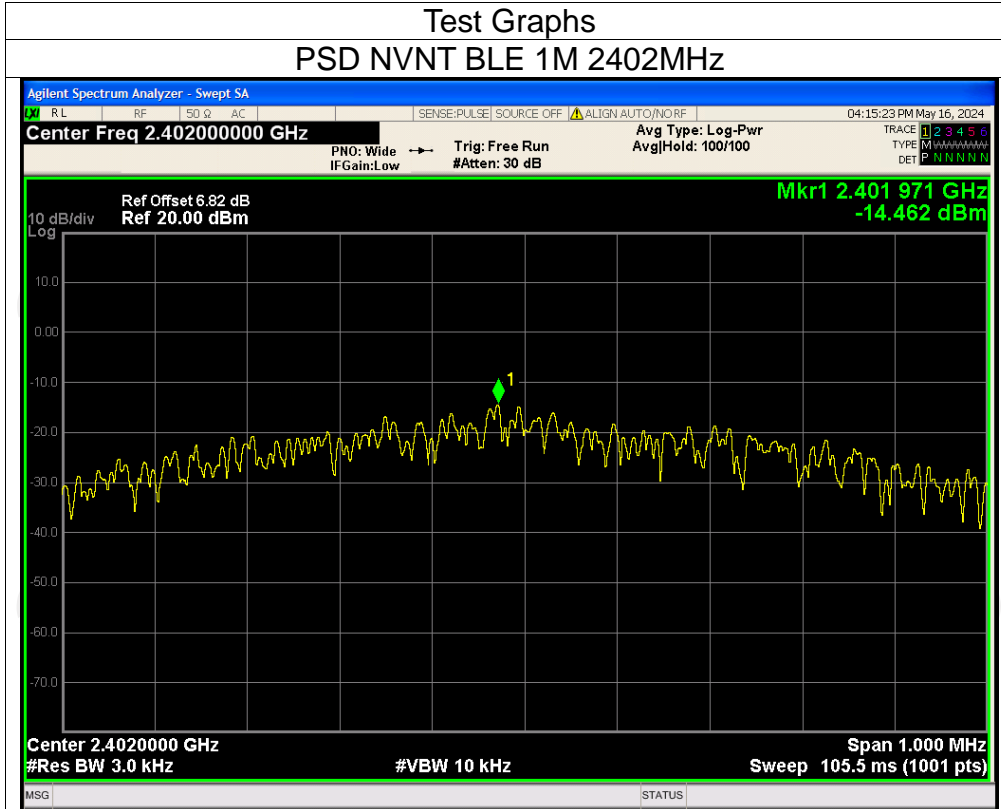

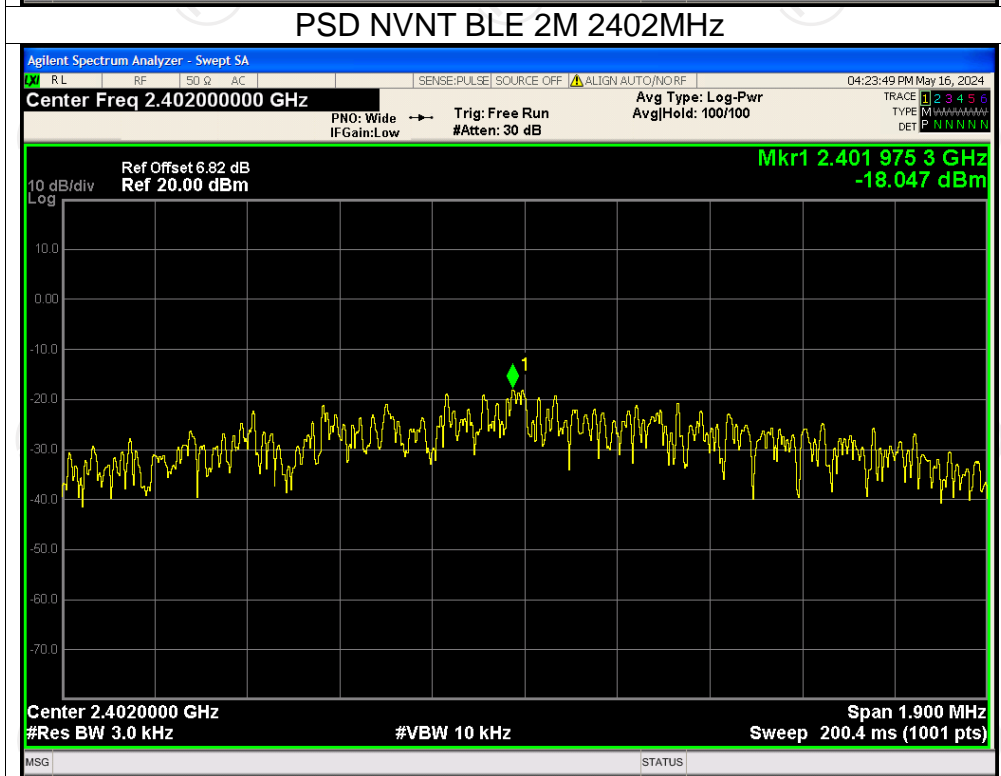
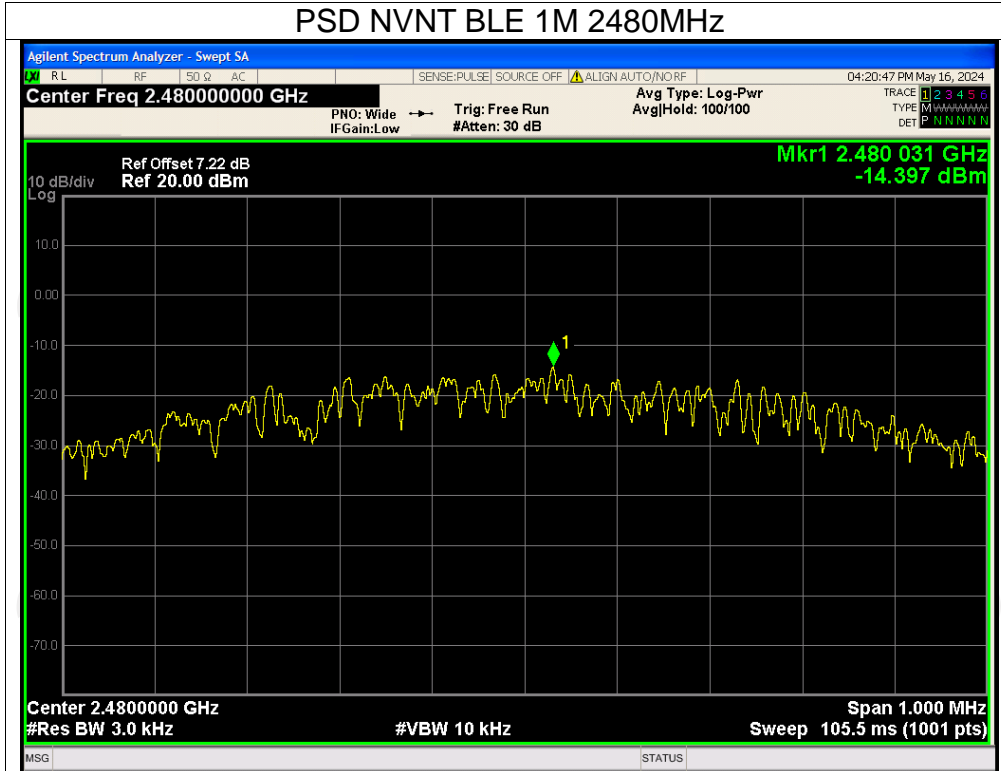

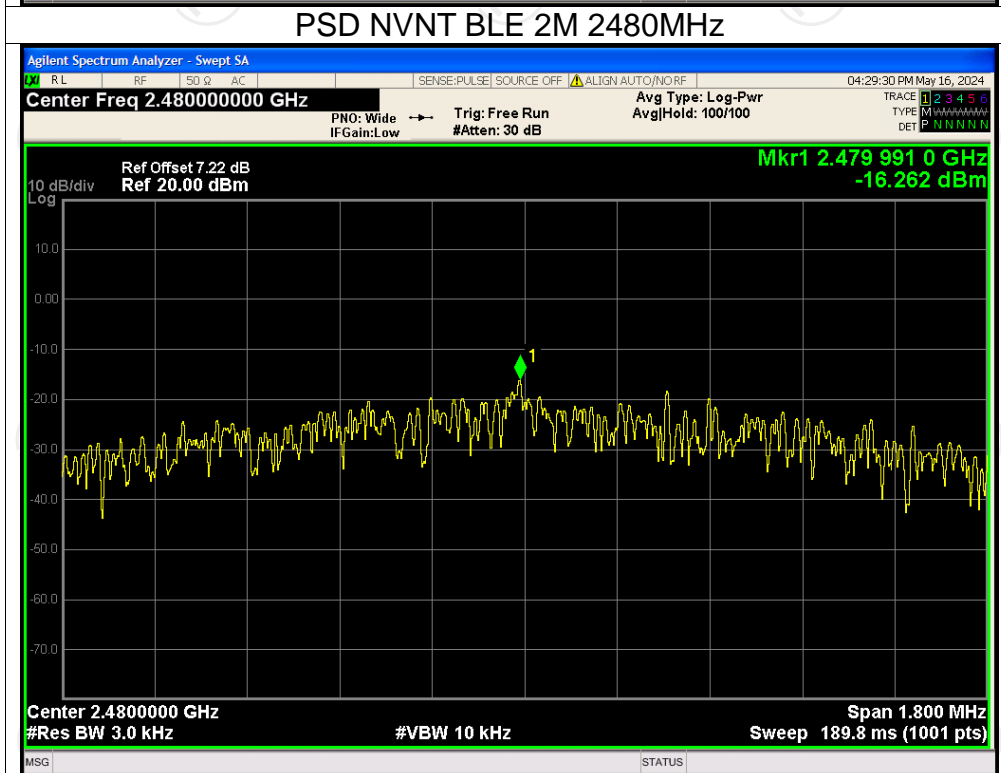
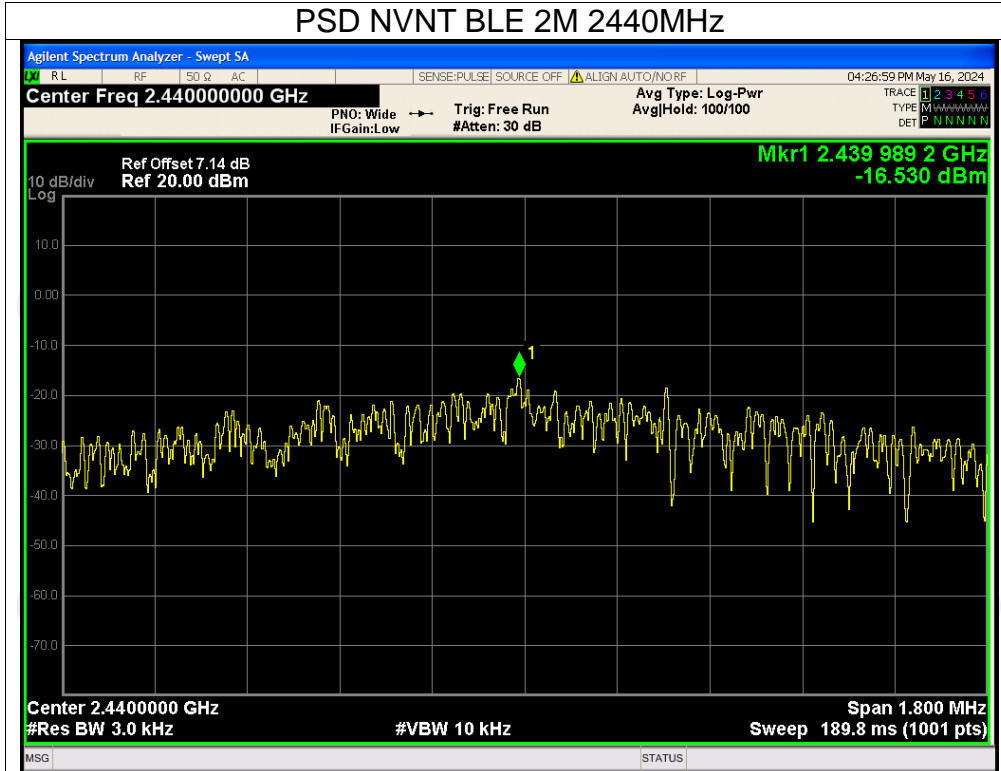

Band Edge

| Condition | Mode | Frequency (MHz) | Max Value (dBc) | Limit (dBc) | Verdict |
|-----------|--------|-----------------|-----------------|-------------|---------|
| NVNT | BLE 1M | 2402 | -50.56 | -20 | Pass |
| NVNT | BLE 1M | 2480 | -50.85 | -20 | Pass |
| NVNT | BLE 2M | 2402 | -49.88 | -20 | Pass |
| NVNT | BLE 2M | 2480 | -50.69 | -20 | Pass |



Test Graphs
Band Edge NVNT BLE 1M 2402MHz Ref

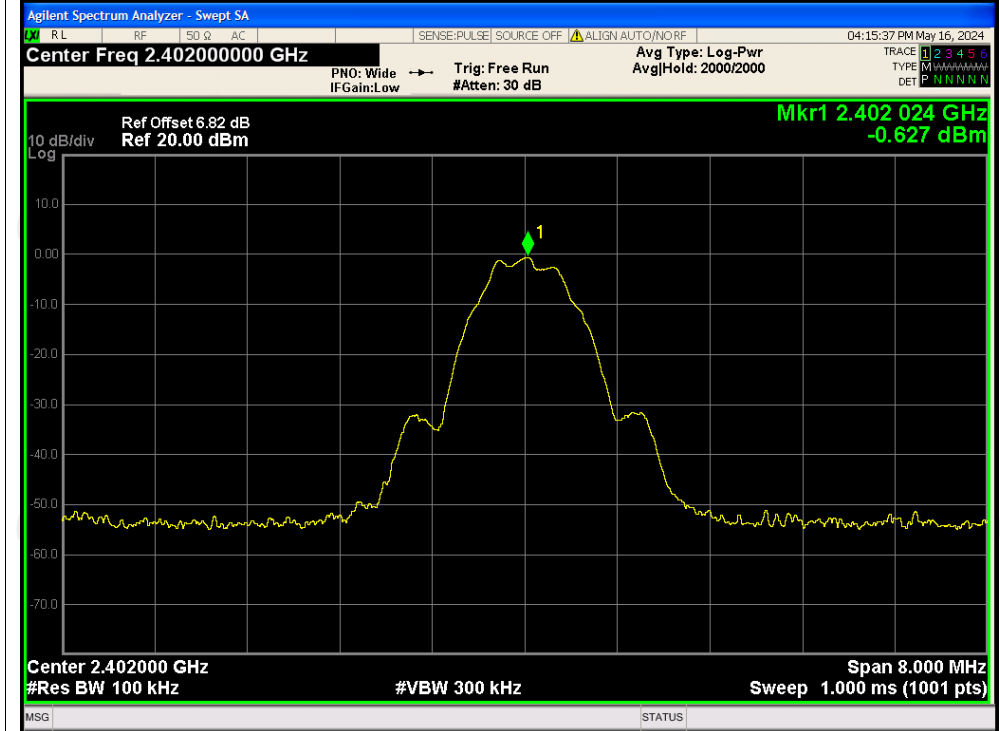

Band Edge NVNT BLE 1M 2402MHz Emission

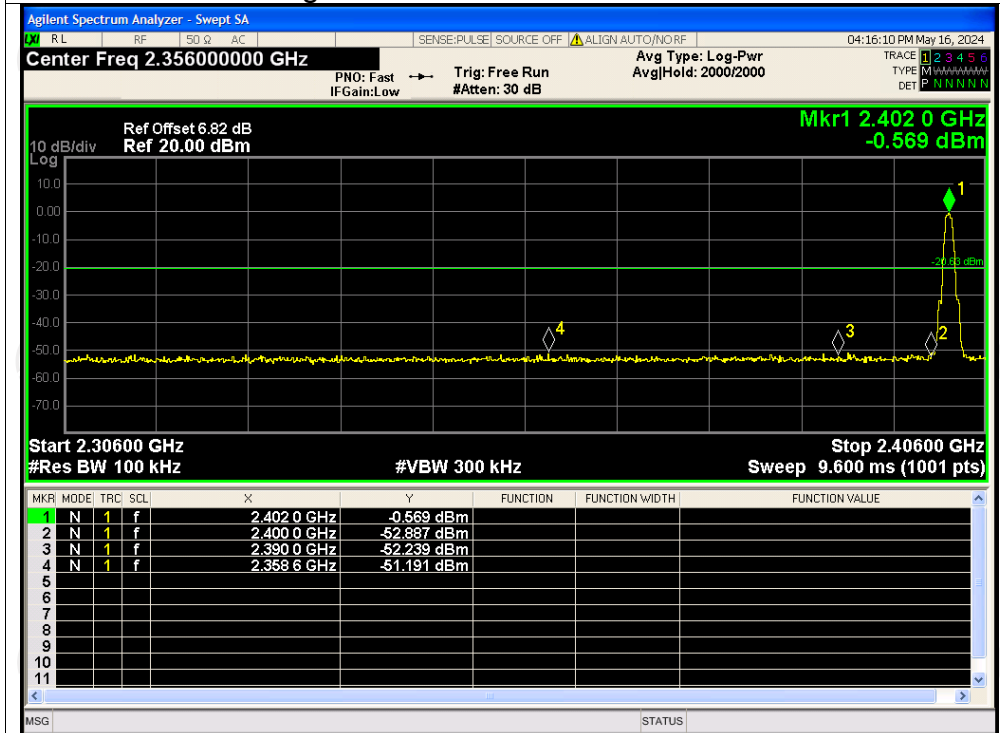

Band Edge NVNT BLE 1M 2480MHz Ref

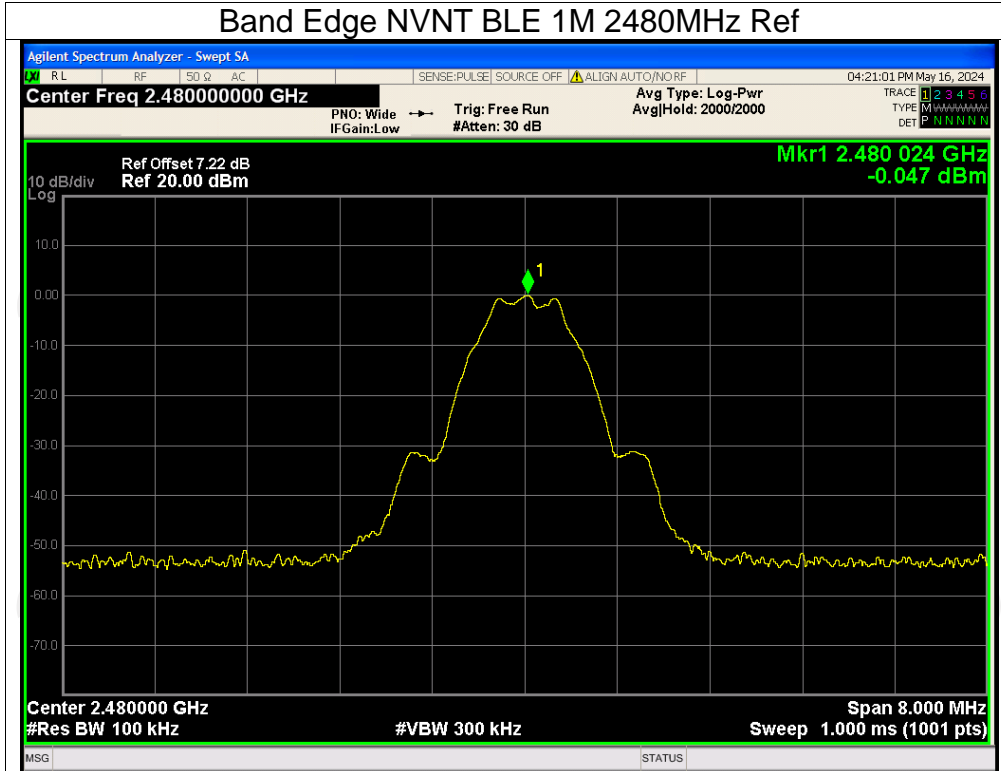

Band Edge NVNT BLE 1M 2480MHz Emission

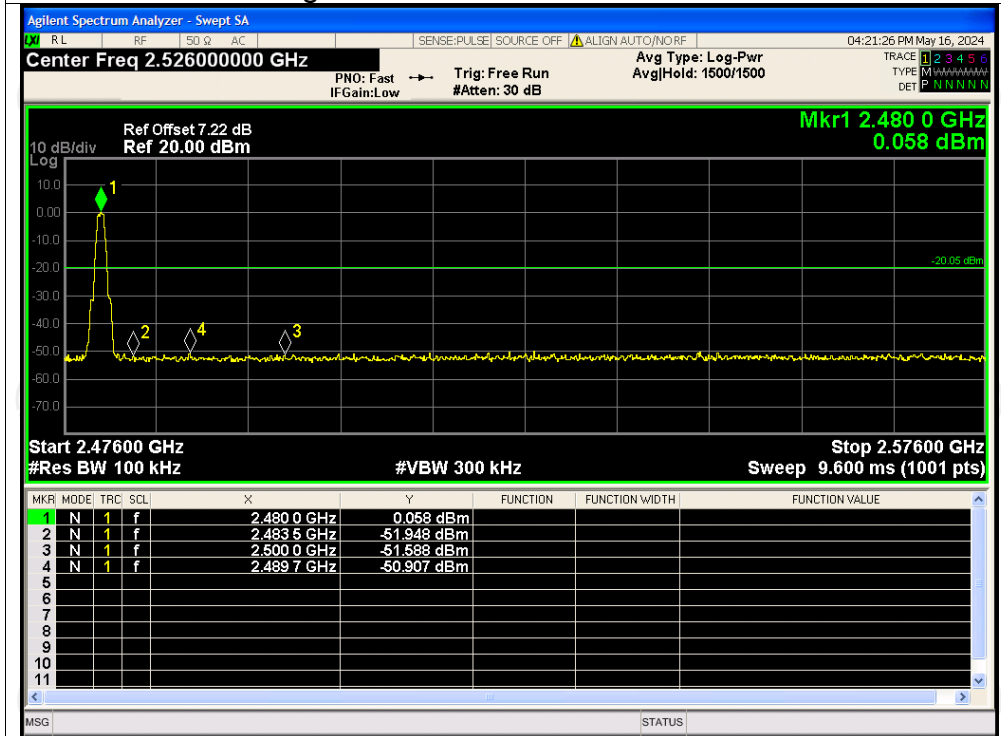

Band Edge NVNT BLE 2M 2402MHz Ref

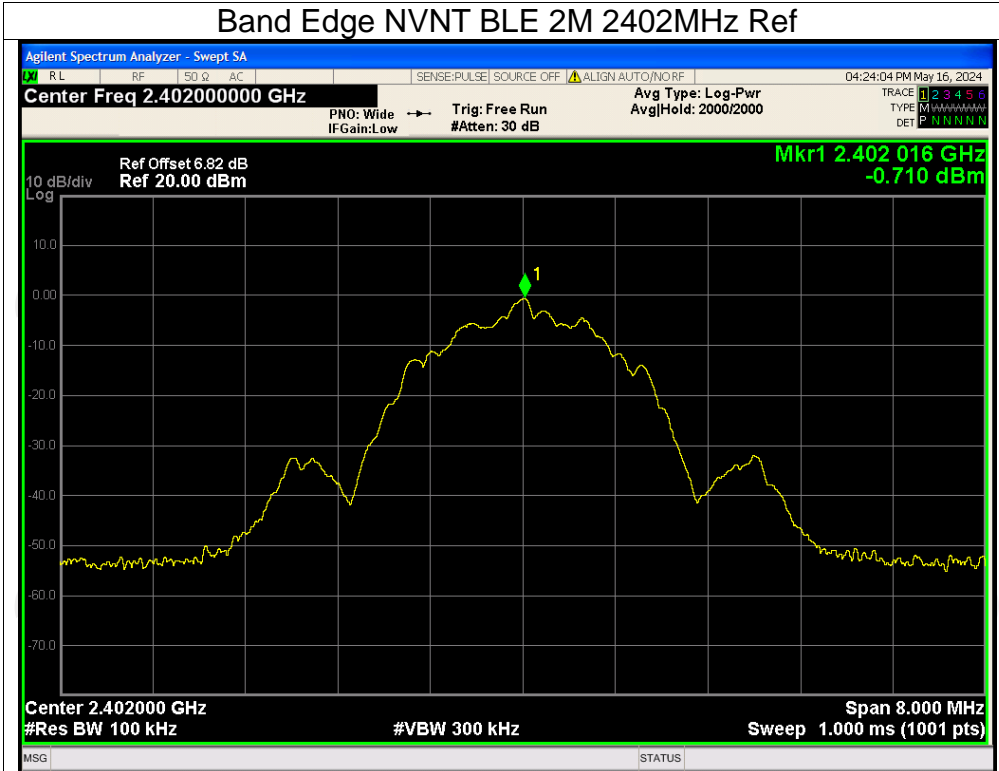

Band Edge NVNT BLE 2M 2402MHz Emission

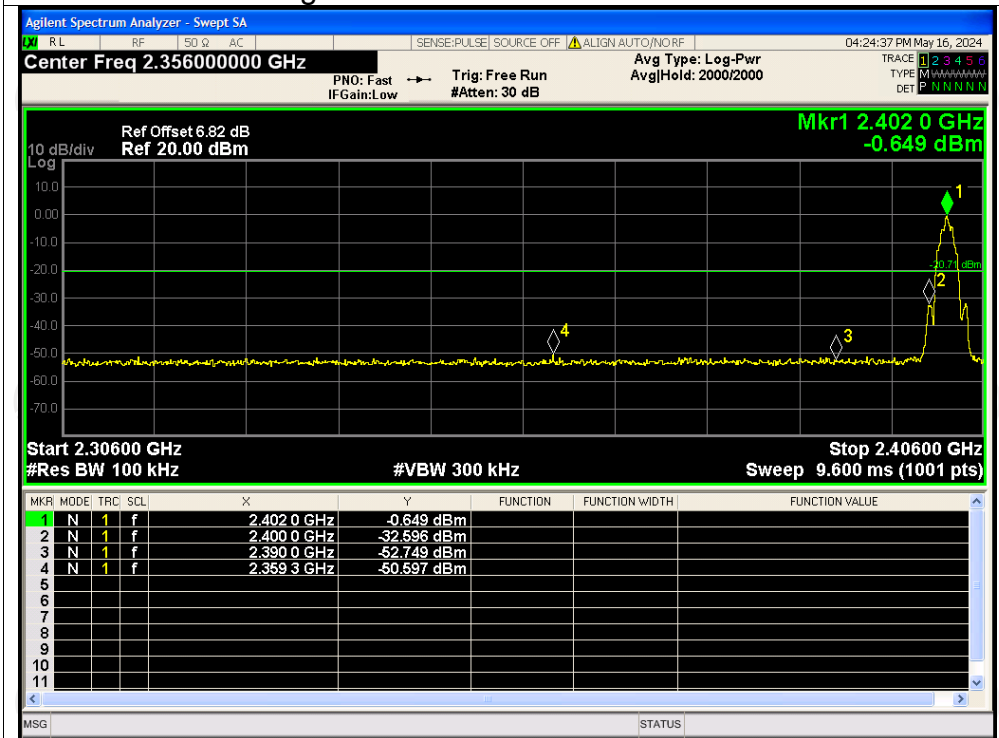

Band Edge NVNT BLE 2M 2480MHz Ref

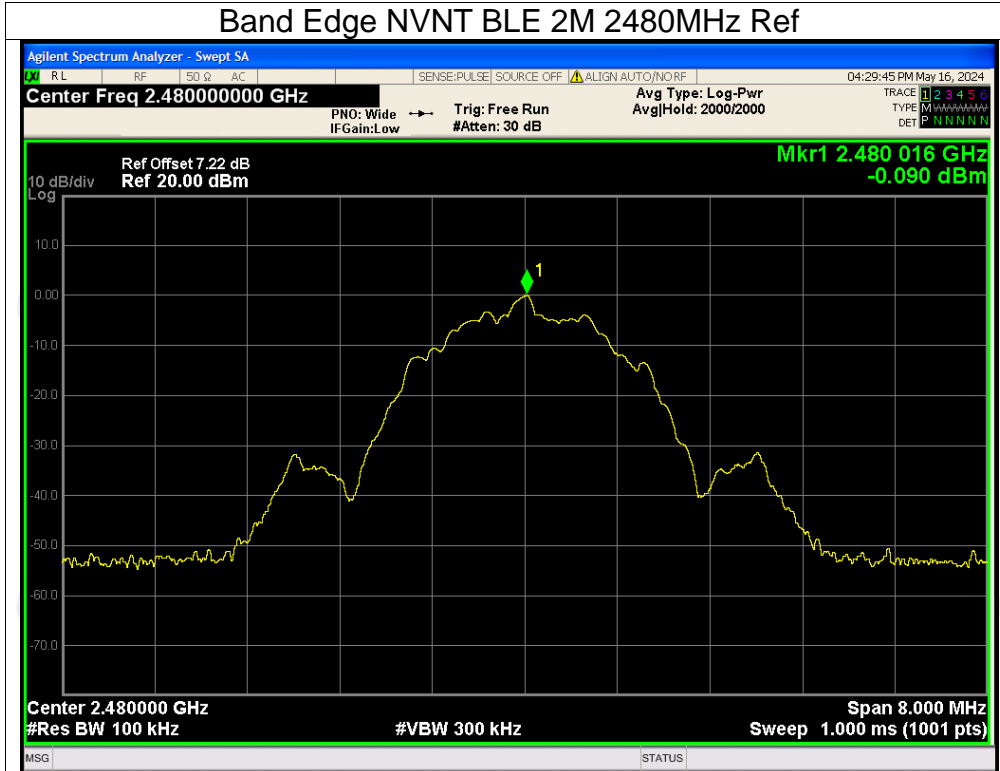

Band Edge NVNT BLE 2M 2480MHz Emission

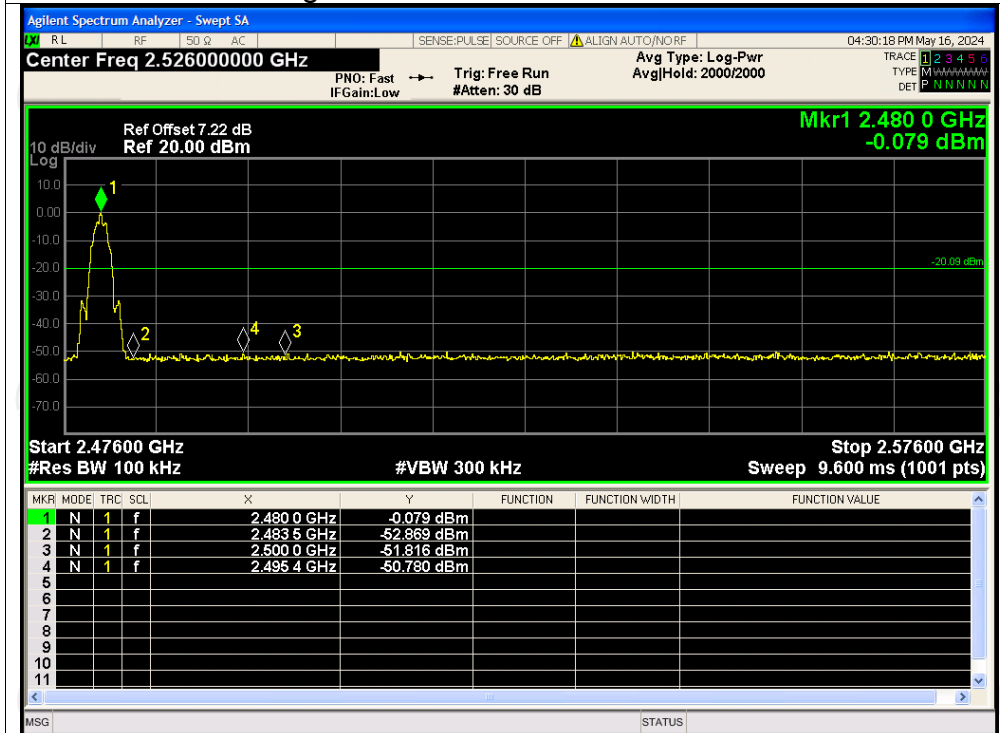

Conducted RF Spurious Emission

| Condition | Mode | Frequency (MHz) | Max Value (dBc) | Limit (dBc) | Verdict |
|-----------|--------|-----------------|-----------------|-------------|---------|
| NVNT | BLE 1M | 2402 | -36.31 | -20 | Pass |
| NVNT | BLE 1M | 2440 | -34.57 | -20 | Pass |
| NVNT | BLE 1M | 2480 | -35.28 | -20 | Pass |
| NVNT | BLE 2M | 2402 | -35.09 | -20 | Pass |
| NVNT | BLE 2M | 2440 | -34.15 | -20 | Pass |
| NVNT | BLE 2M | 2480 | -35.16 | -20 | Pass |

Test Graphs

Tx. Spurious NVNT BLE 1M 2402MHz Ref

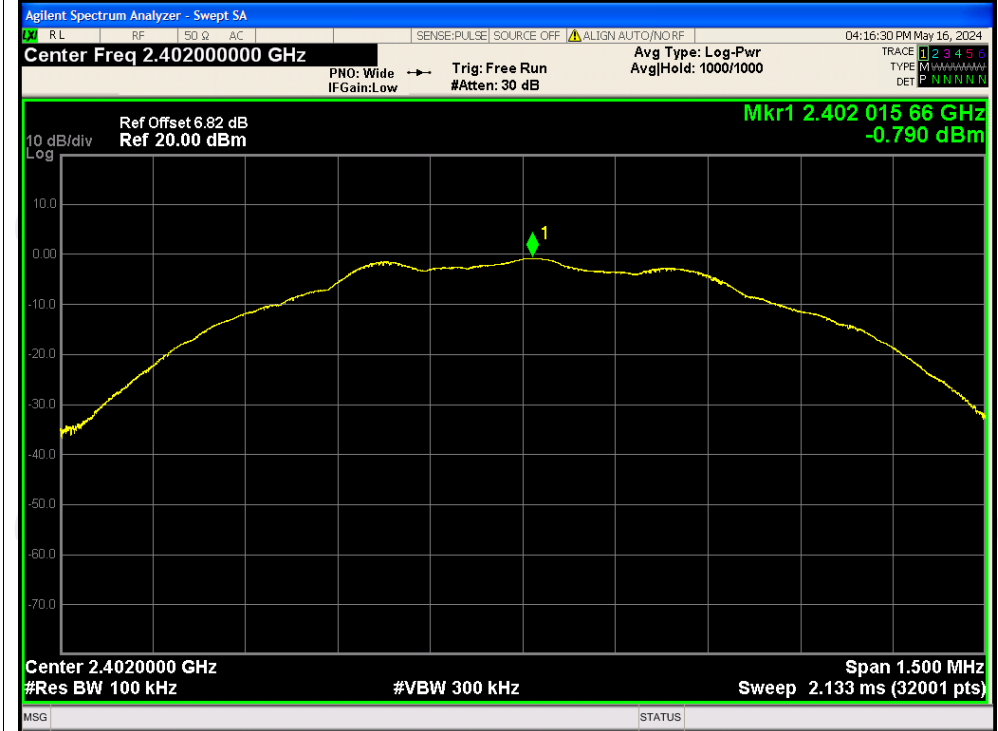

Tx. Spurious NVNT BLE 1M 2402MHz Emission

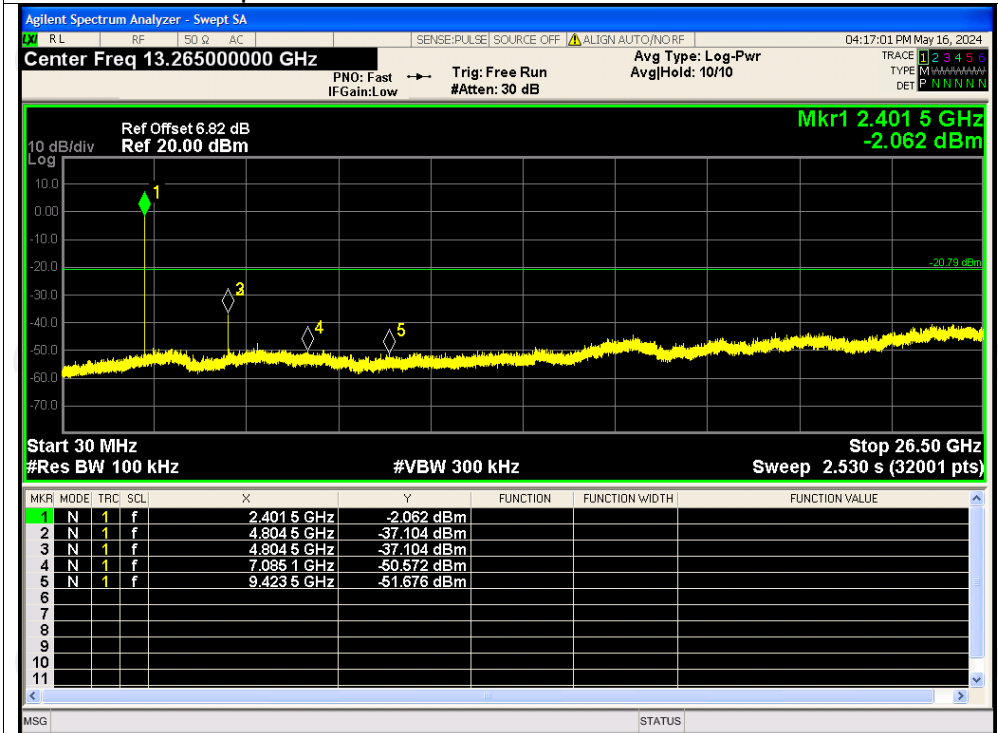

Tx. Spurious NVNT BLE 1M 2440MHz Ref

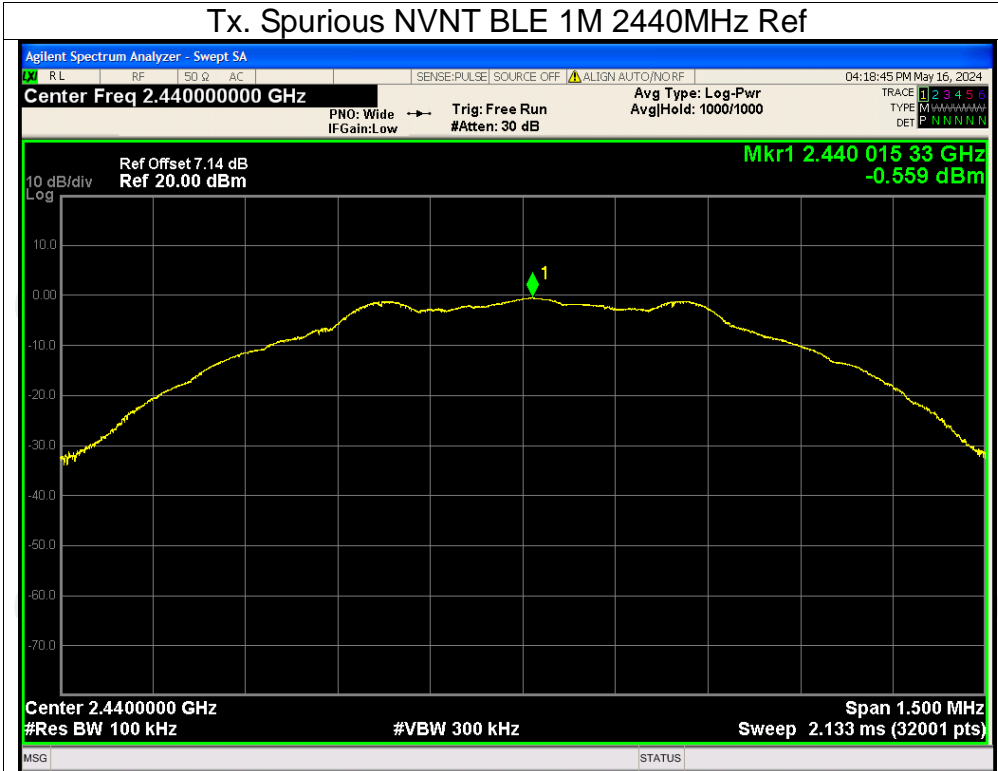

Tx. Spurious NVNT BLE 1M 2440MHz Emission

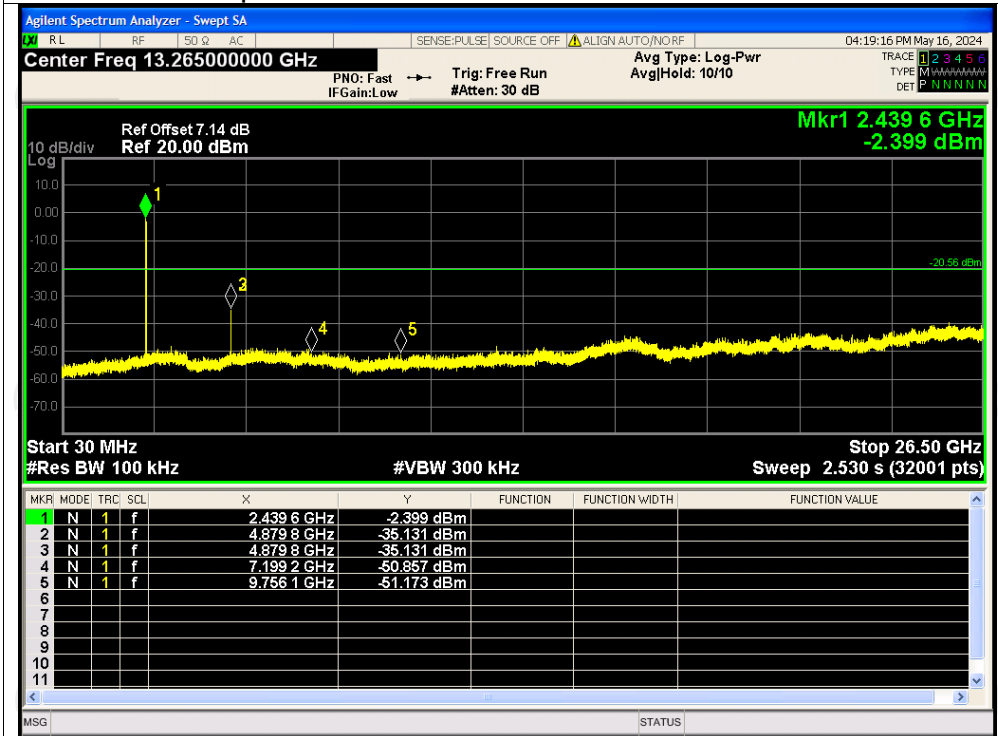

Tx. Spurious NVNT BLE 1M 2480MHz Ref

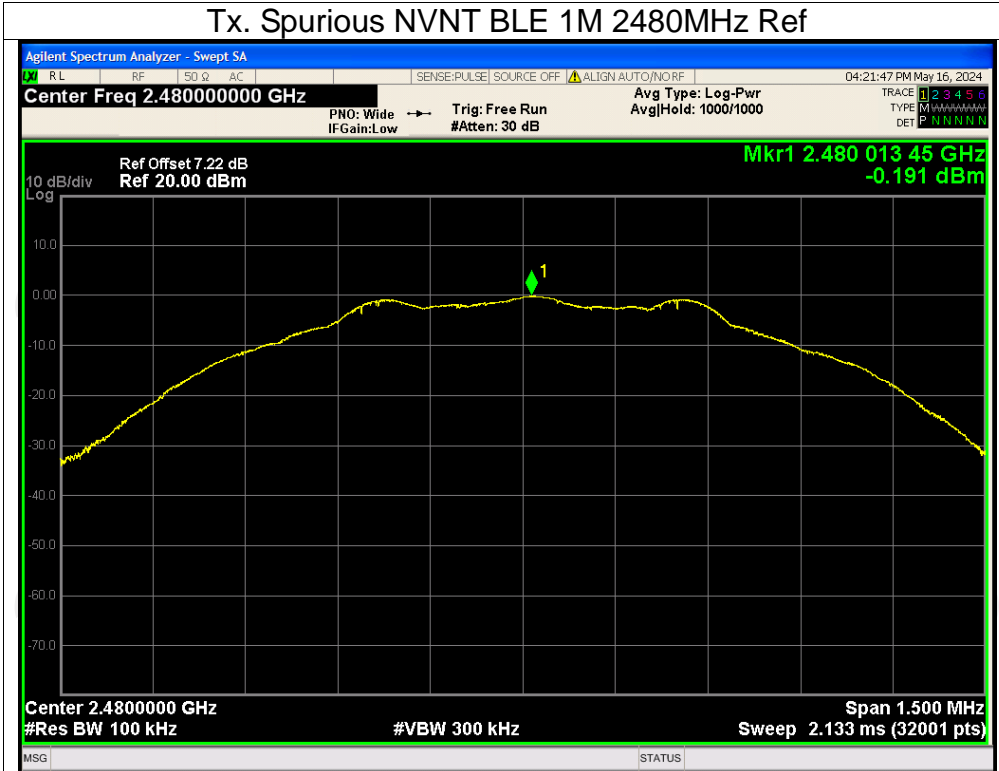

Tx. Spurious NVNT BLE 1M 2480MHz Emission

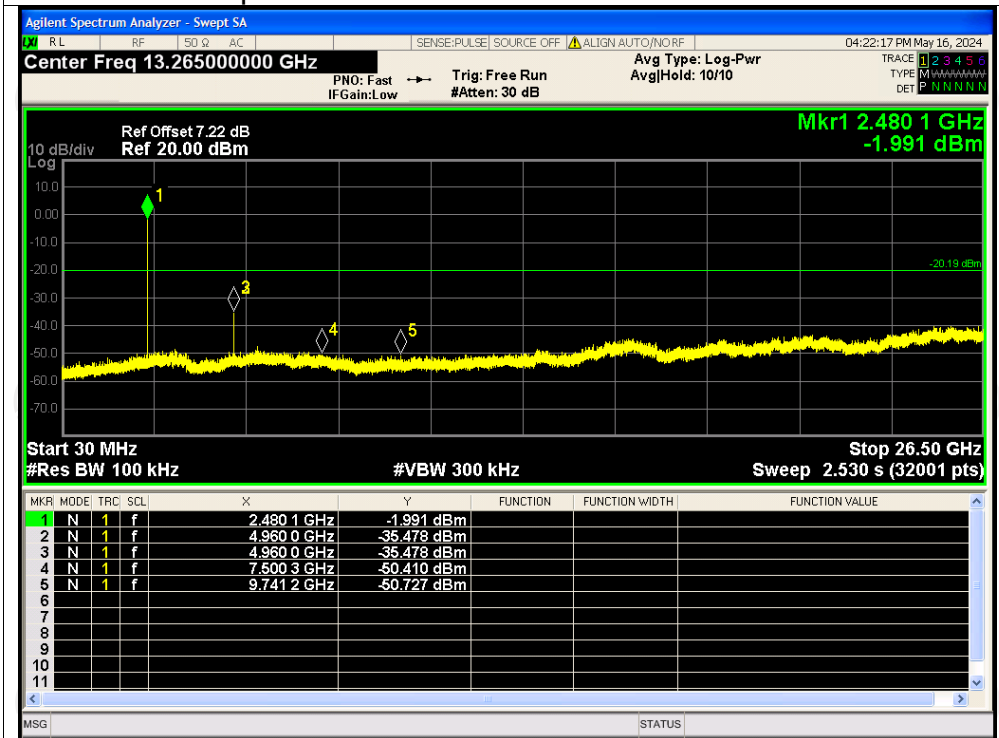

Tx. Spurious NVNT BLE 2M 2402MHz Ref

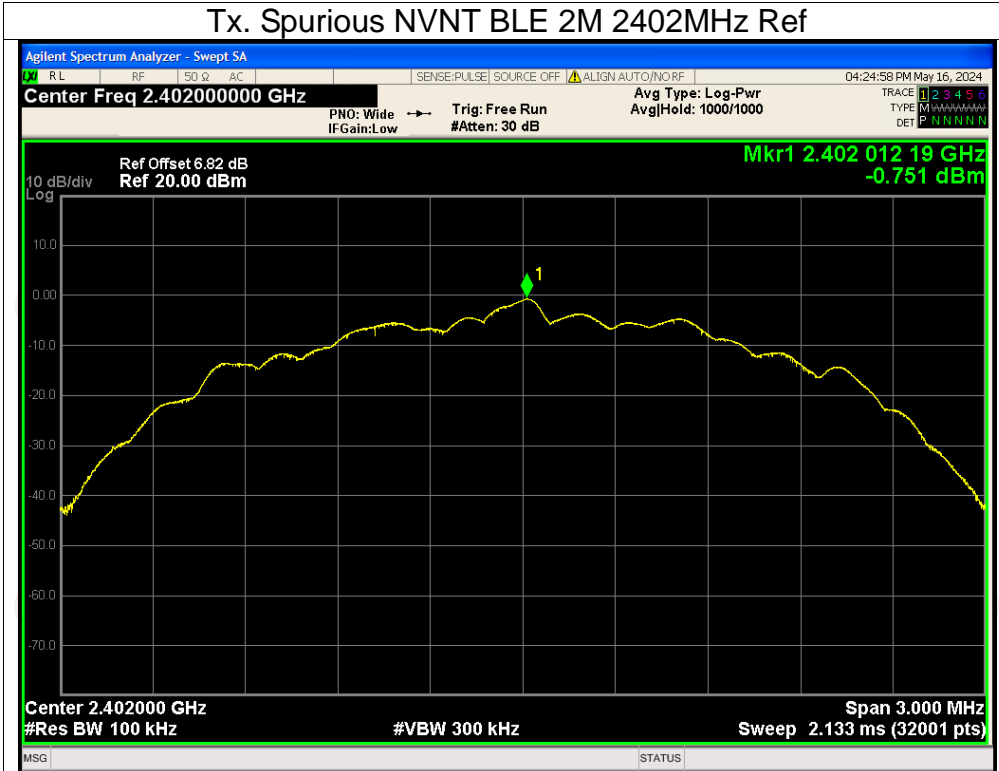

Tx. Spurious NVNT BLE 2M 2402MHz Emission

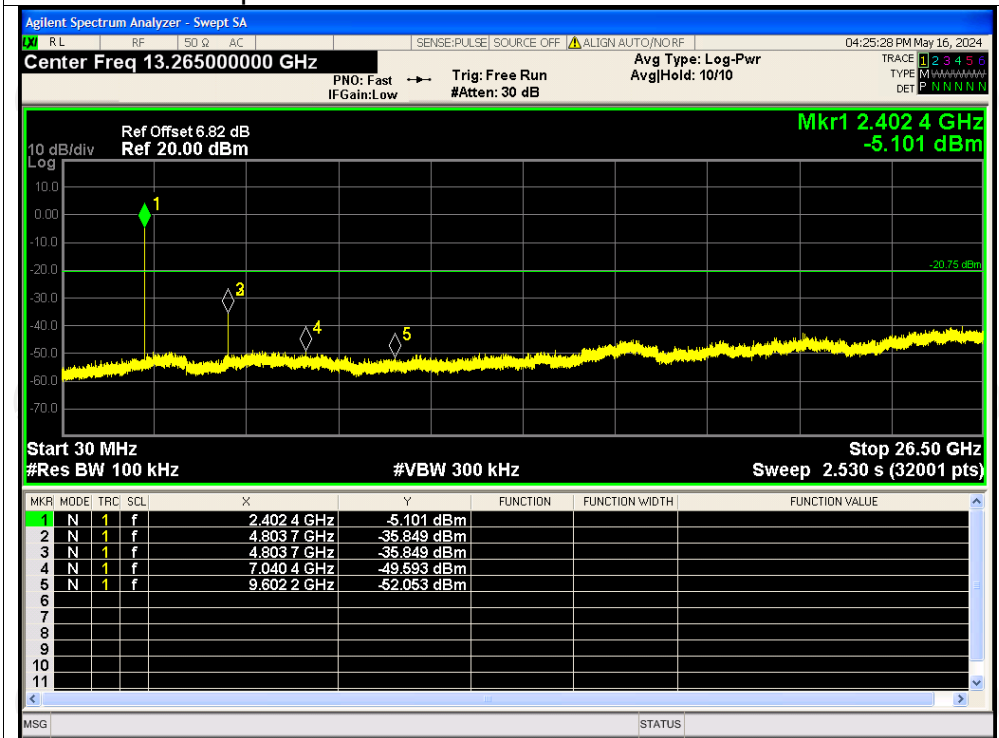

Tx. Spurious NVNT BLE 2M 2440MHz Ref

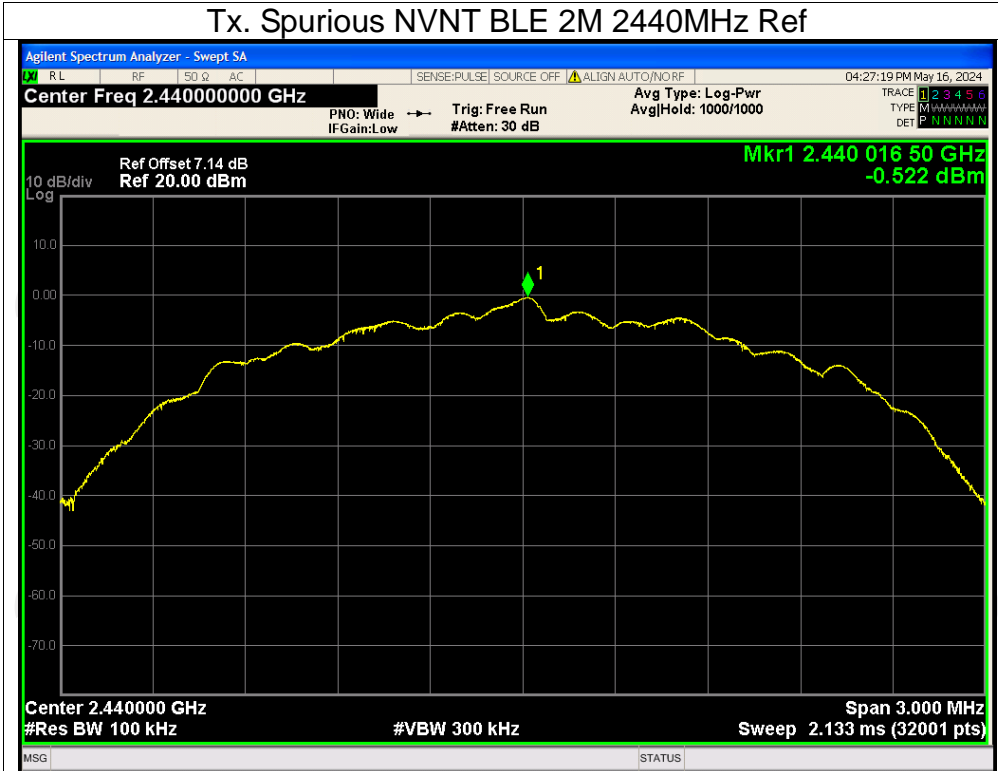

Tx. Spurious NVNT BLE 2M 2440MHz Emission

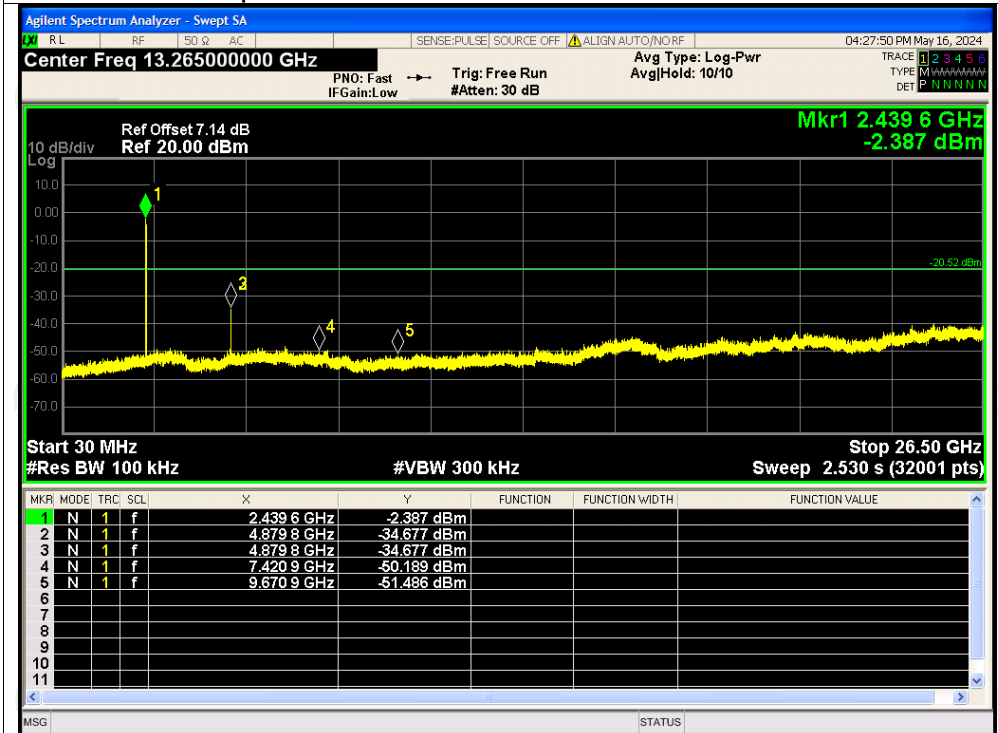

Tx. Spurious NVNT BLE 2M 2480MHz Ref

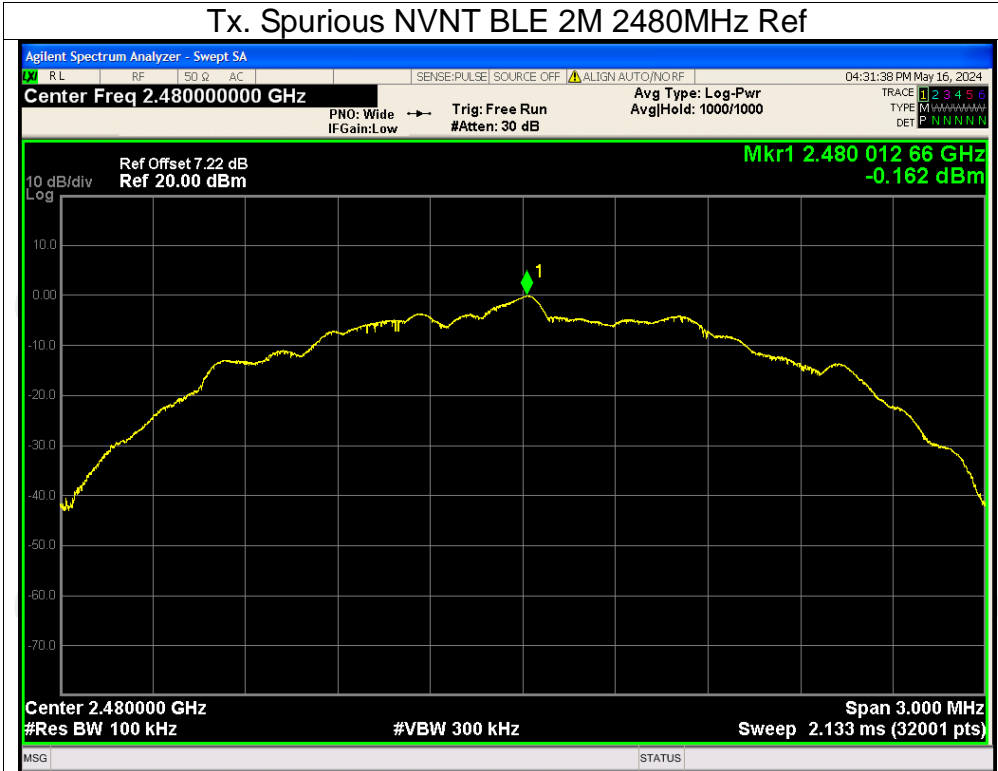

Tx. Spurious NVNT BLE 2M 2480MHz Emission

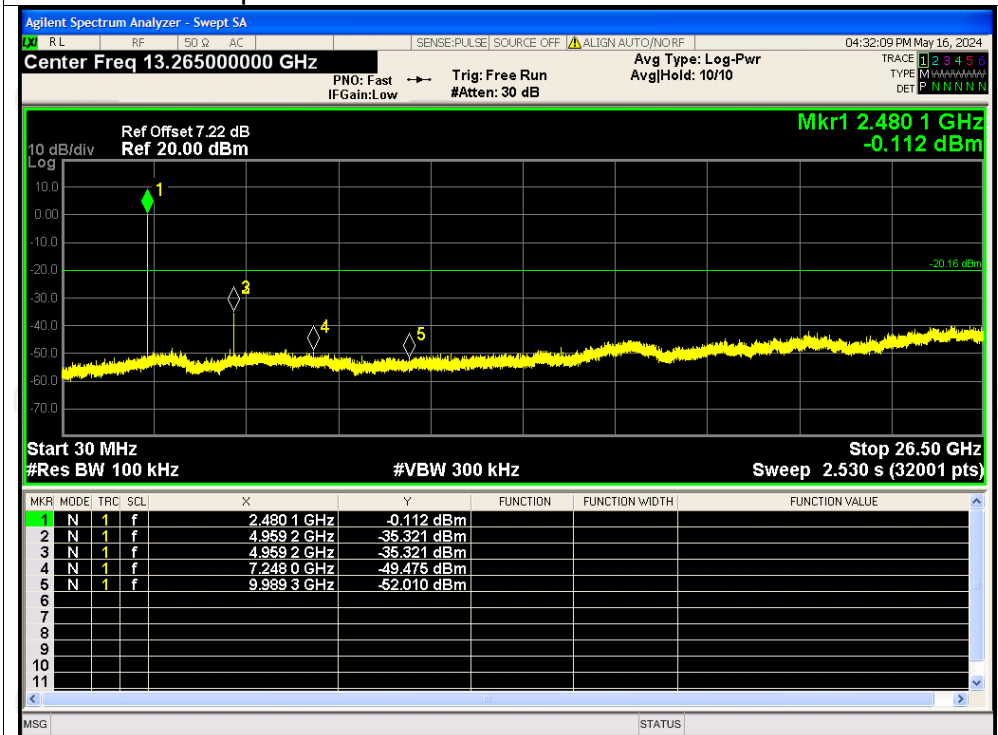

Appendix B: Photographs of Test Setup

Product: Smart Band
Model: T31
Radiated Emission

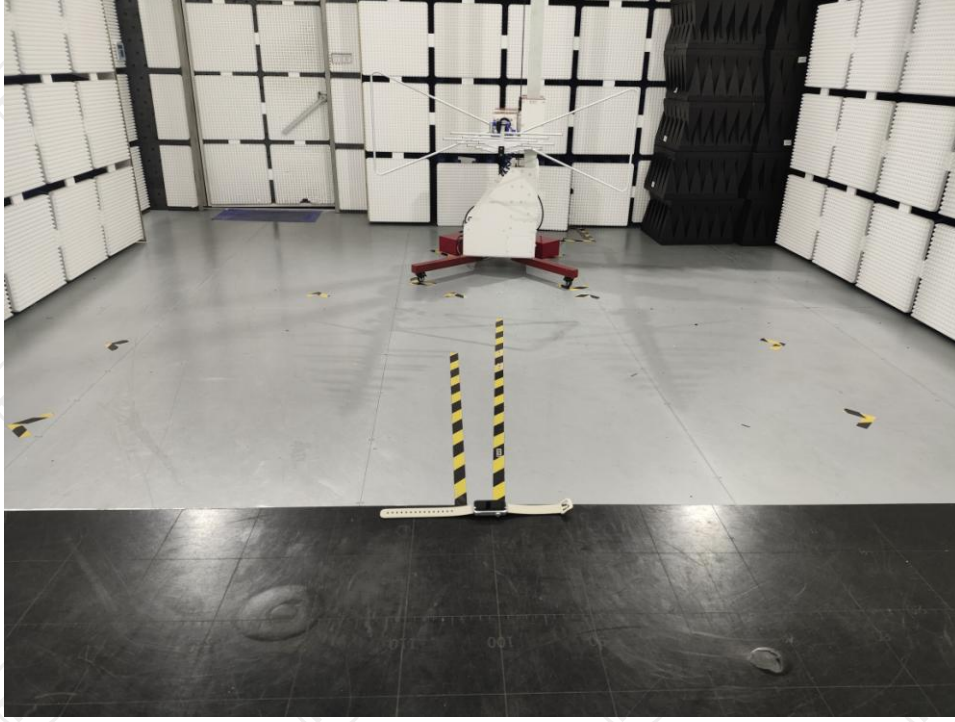

Conducted Emission

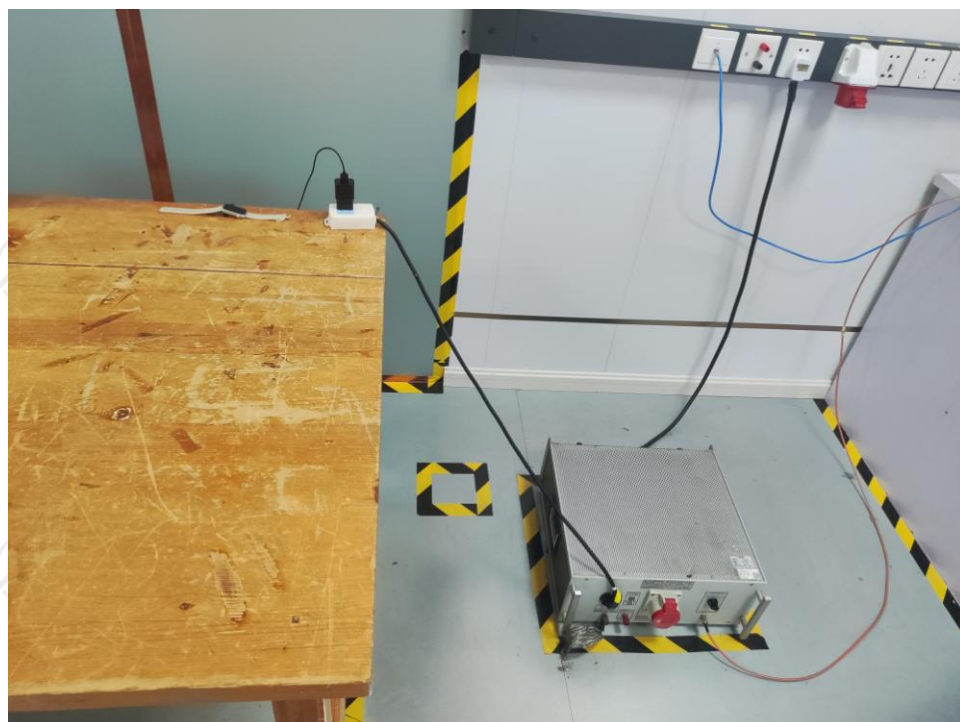

Appendix C: Photographs of EUT
Product: Smart Band
Model: T31
External Photos

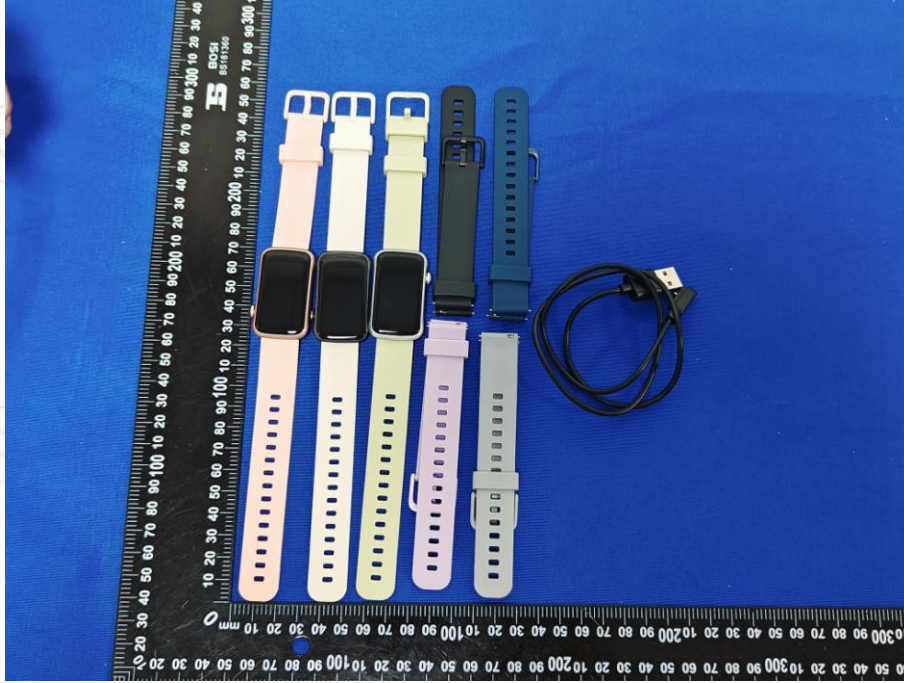

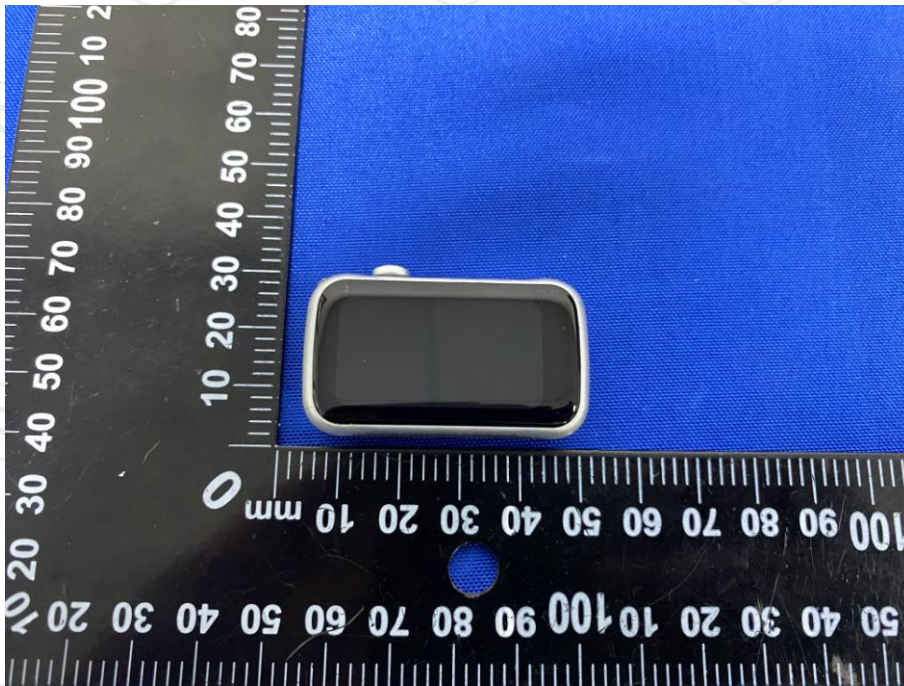
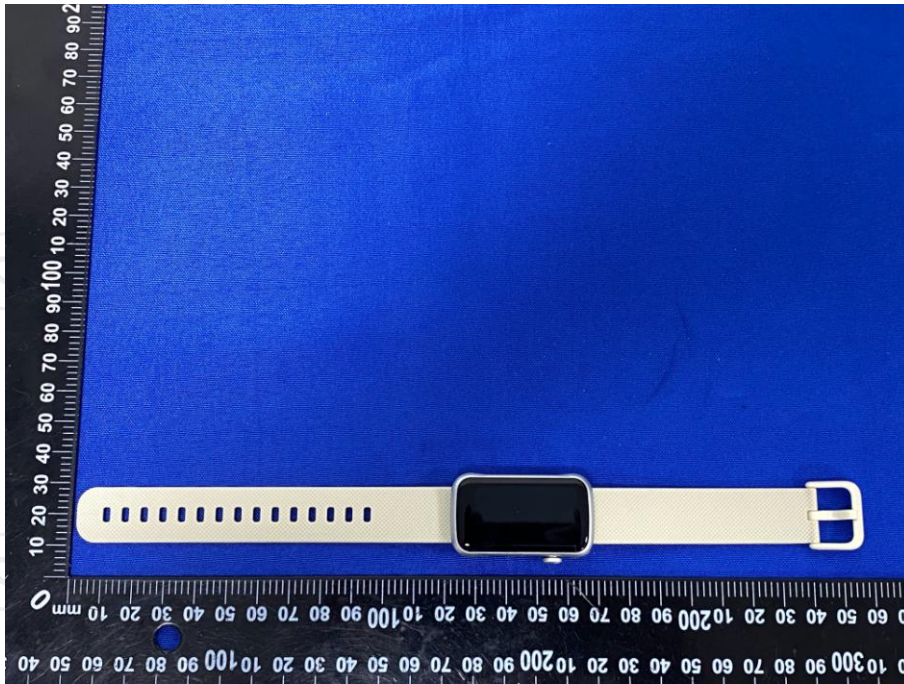

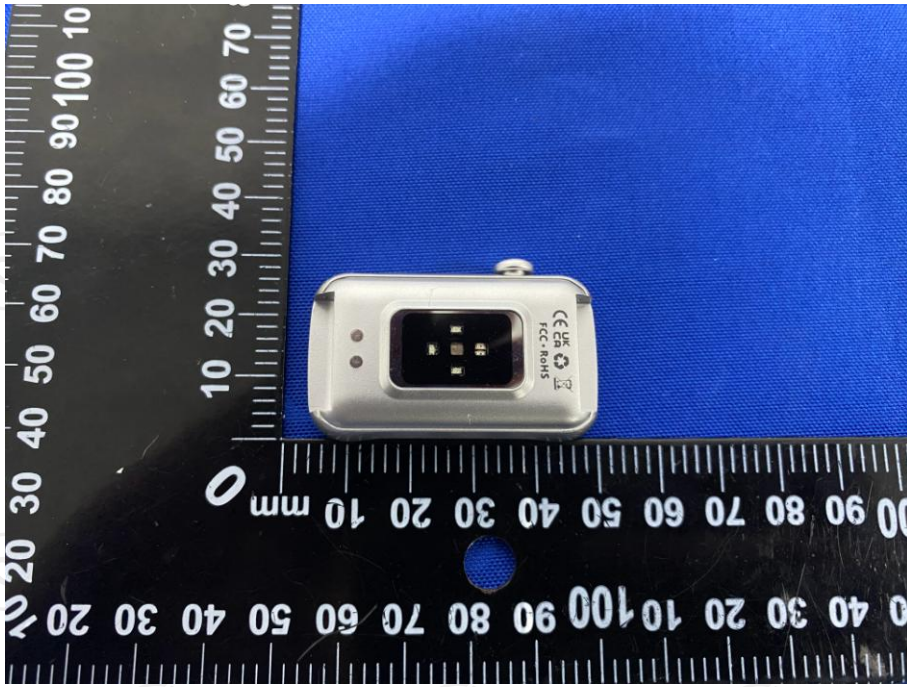

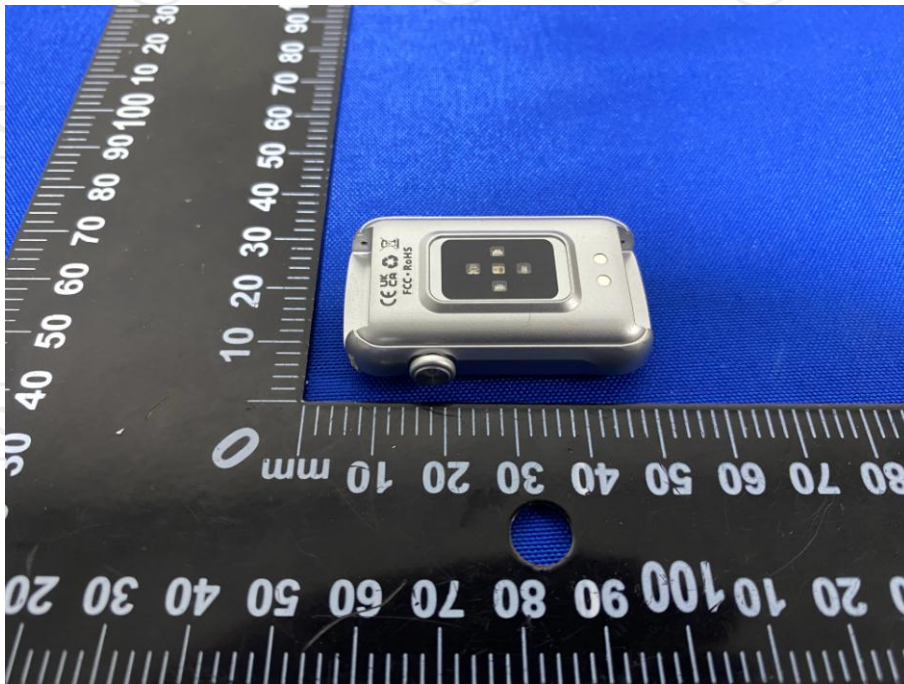

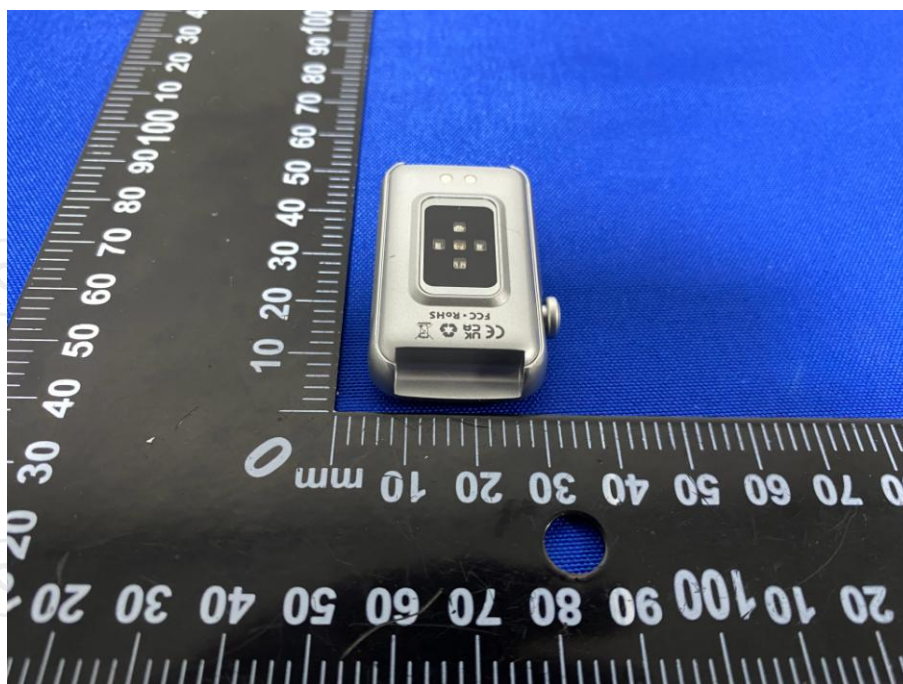

Product: Smart Band
Model: T31
Internal Photos

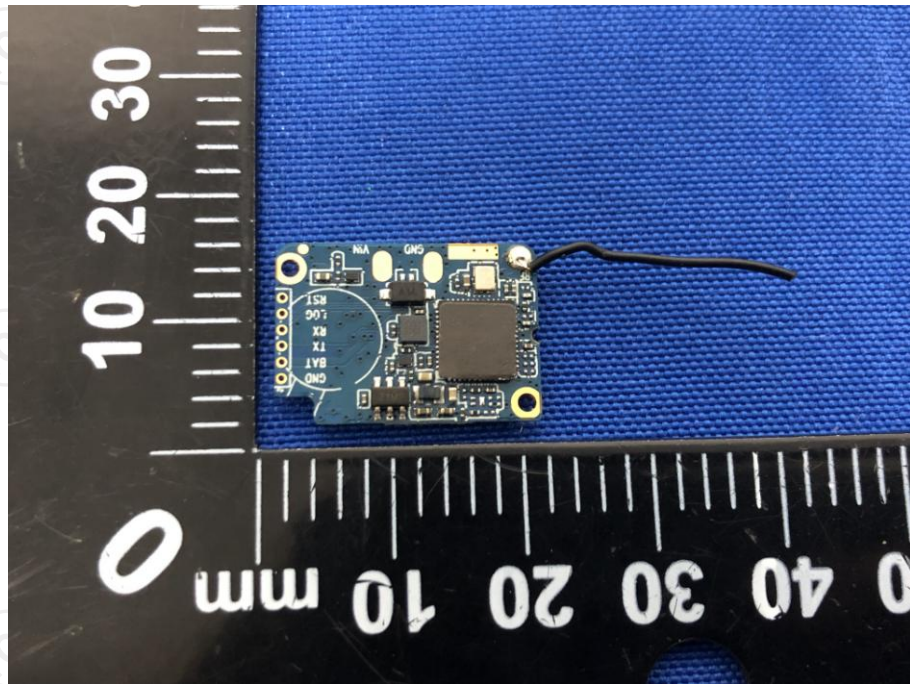
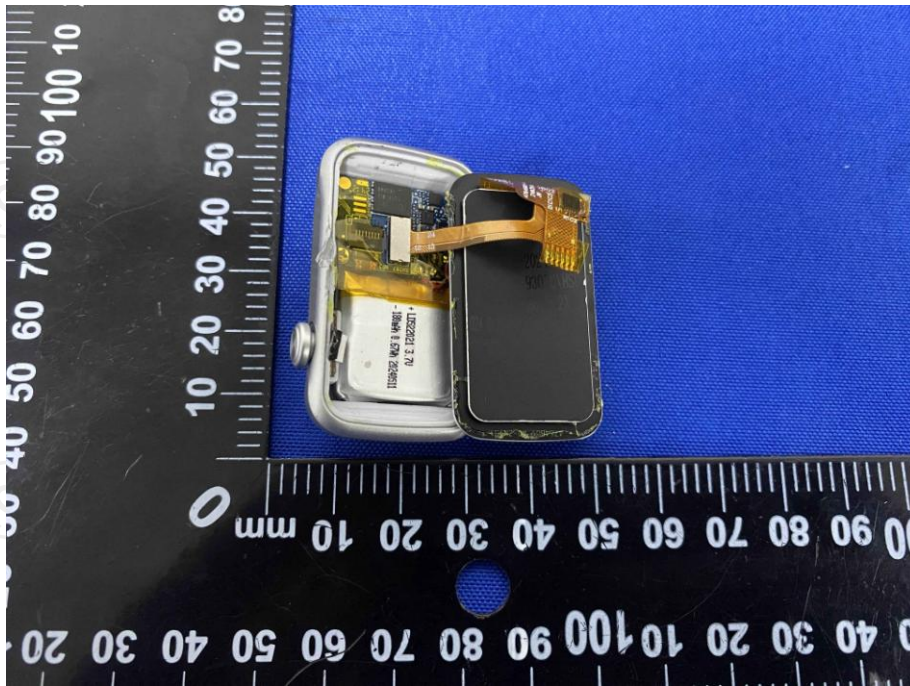

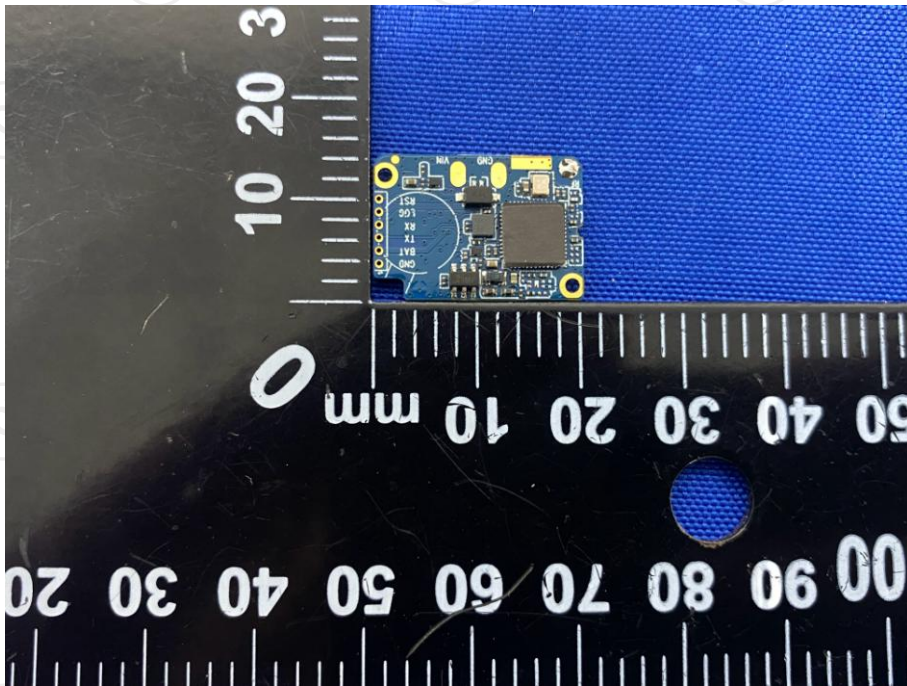
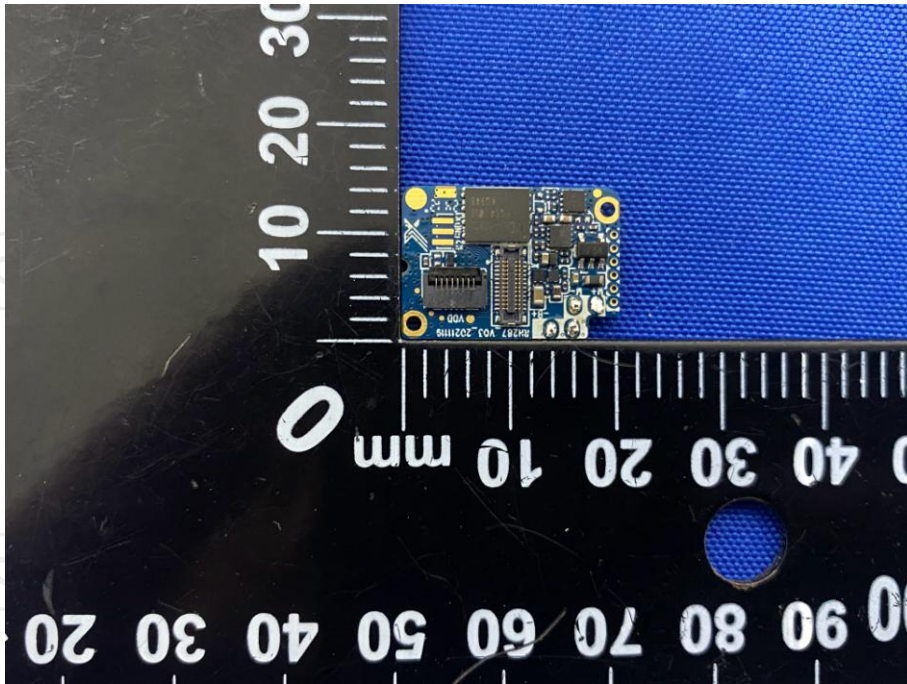

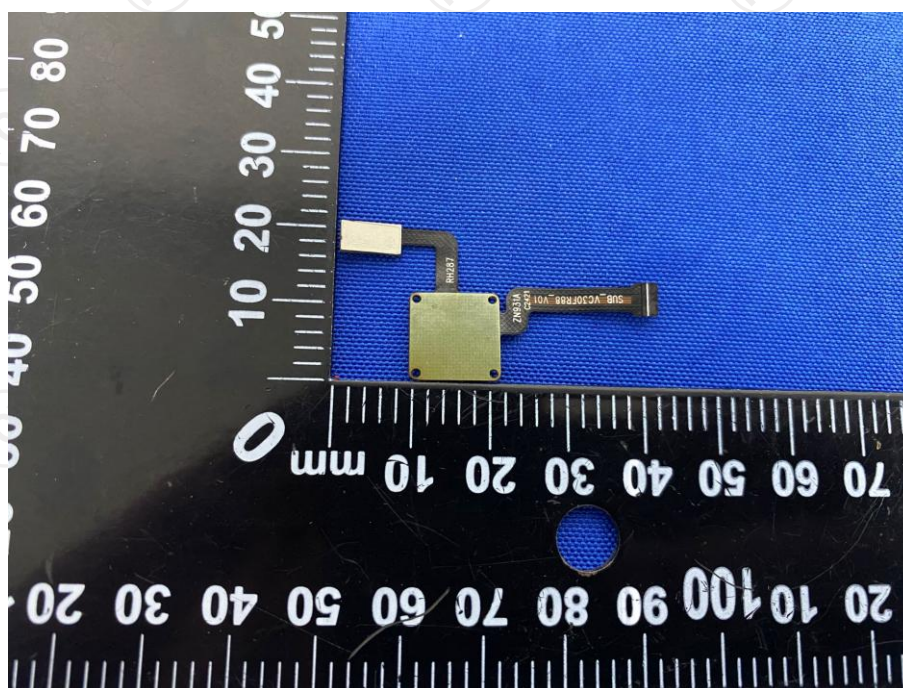
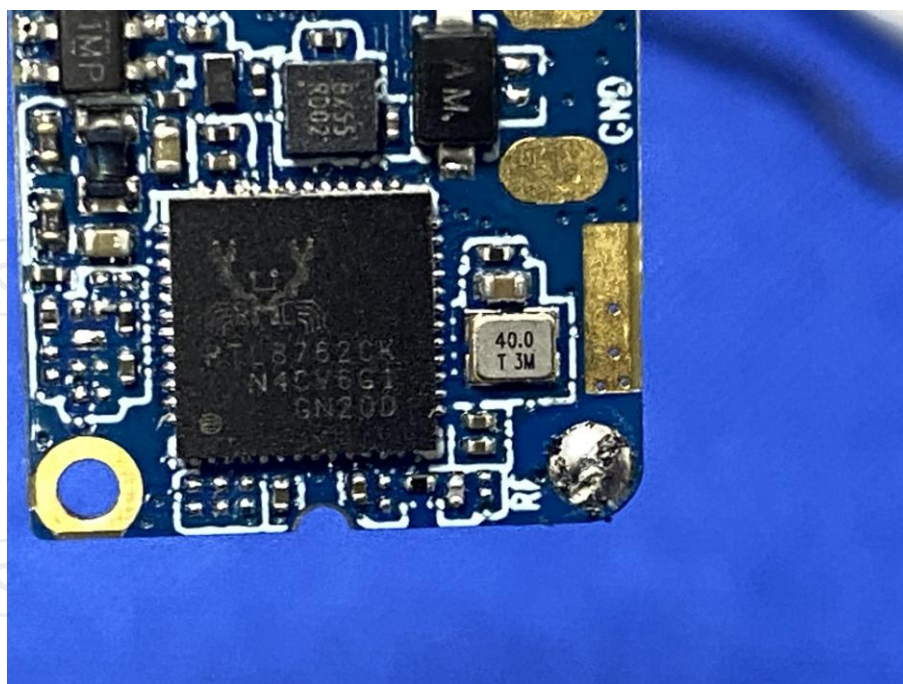

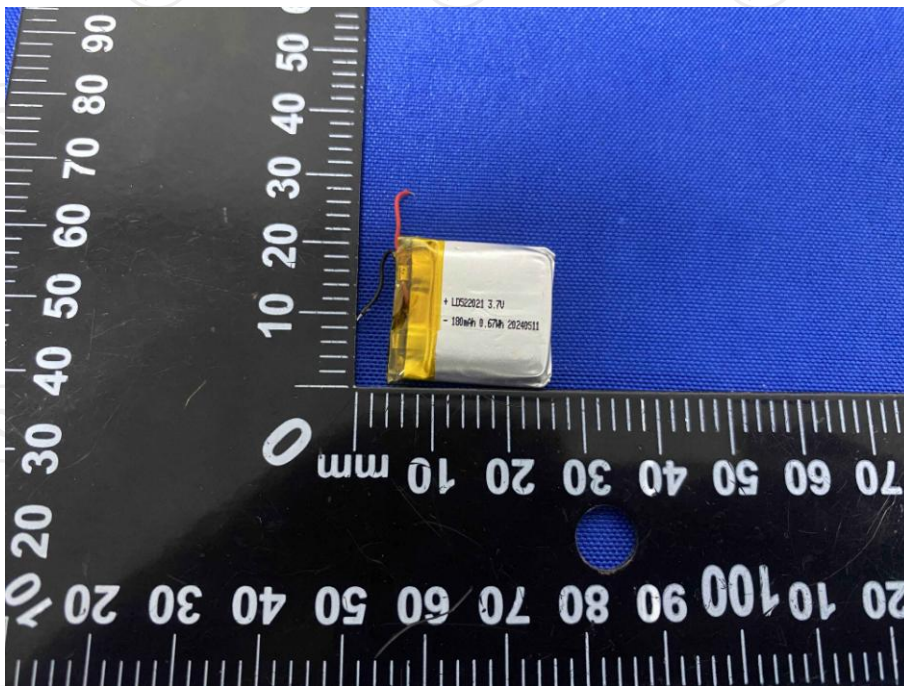
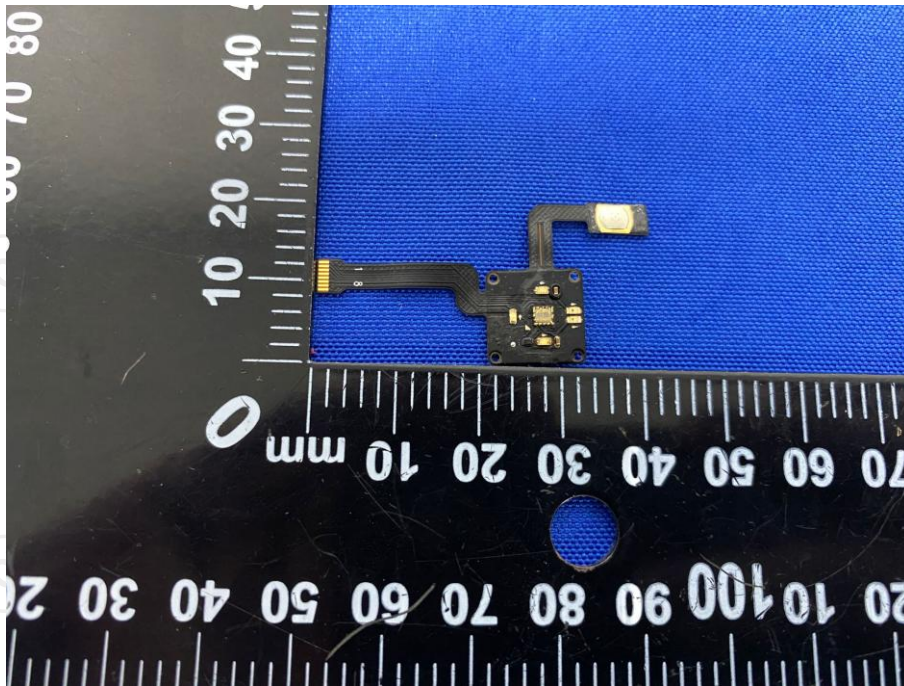

*******END OF REPORT*******