

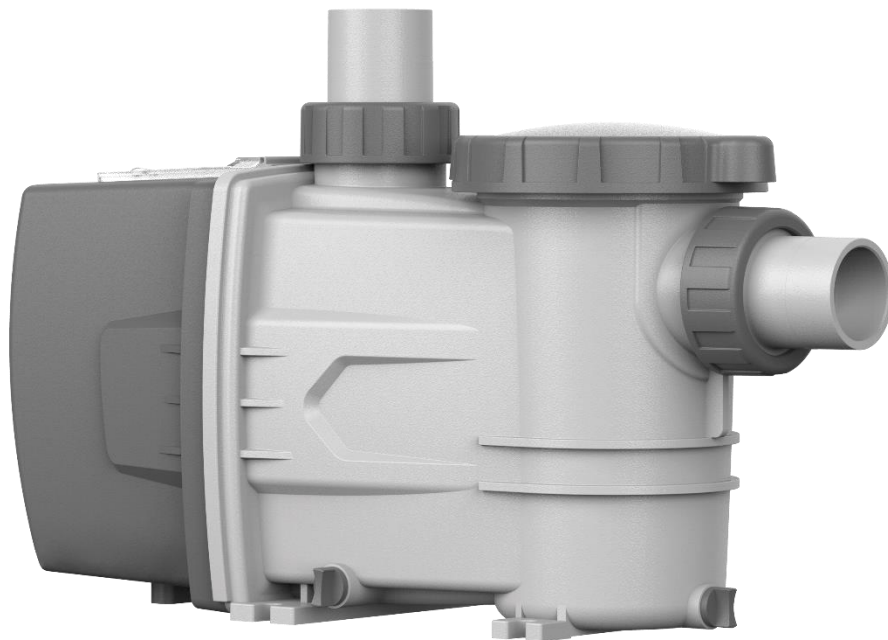

**PMM VARIABLE SPEED SWIMMING POOL PUMPS
INSTRUCTION MANUAL**



**VER.001
SMP7502EWW**

CONGRATULATIONS!

YOU HAVE PURCHASED A HIGH QUALITY REPLACEMENT PUMP FROM STARMATRIX. ALL PUMPS COVERED IN THIS MANUAL HAVE FULL RATED MOTORS AND HAVE BEEN MANUFACTURED AND TESTED TO OFFER MANY YEARS OF TROUBLE FREE SERVICE.

IMPORTANT – READ THIS MANUAL CAREFULLY

NOTE – To prevent potential injury and to avoid unnecessary service calls, read this manual carefully and completely.

SAVE THIS INSTRUCTION MANUAL

Use of unauthorized replacement parts voids warranty.

ATTENTION INSTALLER – THIS MANUAL CONTAINS IMPORTANT INFORMATION ABOUT THE INSTALLATION, OPERATION, AND SAFE USE OF THIS PUMP AND MUST BE FURNISHED TO THE END USER OF THIS PRODUCT. FAILURE TO READ AND FOLLOW ALL INSTRUCTIONS COULD RESULT IN SERIOUS INJURY.

THIS MANUAL IS BROKEN INTO SEVERAL SECTIONS:

- 1. Safety Instructions & Warnings**
- 2. General Installation Instructions**
- 3. Electrical & Wiring Instructions**
- 4. Start-Up & Operation**
- 5. Programming Variable Speed Operation**
- 6. Maintenance, Storage & Winterization**
- 7. Technical Data for SMP7502EW Pumps**
- 8. Trouble Shooting for Variable Speed SMP7502EW Pumps**
- 9. General Pool Pump Trouble Shooting - FAQ**

Section #1, Safety Instructions

WARNING – To reduce risk of injury, do not permit children to use or climb on this product. Closely supervise children at all times. Components such as the filtration system, pumps, and heaters must be positioned to prevent children from using them as a means of access to the pool.

CAUTION – This pump is intended for use on permanently installed swimming pools and may also be used with hot tubs and spas if so marked. Do NOT use with storable pools. A permanently installed pool is constructed in or on the ground or in a building such that it cannot be readily disassembled for storage. A storable pool is constructed so that it is capable of being readily disassembled for storage and reassembled to its original integrity.

Though this product is designed for outdoor use, it is strongly advised to protect the electrical components from the weather. Select a well-drained area, one that will not flood when it rains. It requires free circulation of air for cooling. Do not install in a damp or unventilated location. If installed within an outer enclosure or beneath the skirt of a hot tub or spa, adequate ventilation and free circulation of air must be provided to prevent overheating of the motor.

WARNING – **Some pump** components have a finite life. All components should be inspected frequently and replaced if found to be worn, damaged, broken, cracked or missing.

WARNING – Risk of Electric Shock.

Hazardous voltage. Can shock, burn, or cause death. To reduce the risk of electric shock, do NOT use an extension cord to connect unit to electric supply. Provide a properly located outlet. It is required that licensed electricians do all electrical wiring. All electrical wiring MUST be in conformance with applicable local and national codes and regulations. Before working on pump or motor, disconnect motor wiring.

WARNING – To reduce the risk of electric shock replace damaged cord immediately. Do NOT bury cord. Locate cord to prevent abuse from lawn mowers, hedge trimmers and other equipment.

WARNING – Connect only to a grounding type receptacle protected by a Ground Fault Circuit Interrupter (GFCI).

Contact a licensed electrician if you cannot verify that the receptacle is protected by a GFCI.

WARNING – Failure to bond pump to pool structure will increase risk for electrocution and could result in injury or death. To reduce the risk of electric shock, see installation instructions and consult a professional electrician on how to bond pump.

WARNING – Suction Entrapment Hazard.

Entrapment in suction outlets and/or suction outlet covers, which are damaged, broken, cracked, missing, or unsecured can cause severe injury and/or death due to the following entrapment hazards:

Hair Entrapment- Hair can become entangled in suction outlet cover.

Limb Entrapment- A limb inserted into an opening of a suction outlet sump or suction outlet cover that is damaged, broken, cracked, missing, or not securely attached can result in a limb becoming entrapped.

Body Suction Entrapment- A pressure applied to a large portion of the body or limbs can result in an entrapment.

Mechanical Entrapment- There is potential for jewelry, swimsuits, hair decorations, fingers, toes, or knuckles to be caught in an opening of a suction outlet cover resulting in mechanical entrapment.

WARNING – Reduce the risk of Entrapment Hazards:

- When outlets are small enough to be blocked by a person, a minimum of two functioning suction outlets per pump must be installed. Suction outlets in the same plane (i.e. floor or wall), must be installed a minimum of three feet (3') [0.91 meter] apart, as measured from near point to near point.
- Dual suction fittings shall be placed in such locations and distances to avoid “dual blockage” by a user.
- Dual suction fittings shall not be located on seating areas or on the backrest for such seating areas.

- The maximum system flow rate shall not exceed the values shown in the “Pipe Sizing Chart” found at the bottom of page 5 of this manual.
- Never use pool if any suction outlet component is damaged, broken, cracked, missing, or not securely attached.
- Replace damaged, broken, cracked, missing, or not securely attached suction outlet components immediately.
- In addition to two or more suction outlets per pump installed in accordance with latest IAF (formerly NSPI) standards and CPSC guidelines, follow all national, state, and local codes applicable.
- Installation of a vacuum release or vent system, which relieves entrapping suction, is recommended.

WARNING – Hazardous Pressure.

Pool water circulation systems operate under hazardous pressure during start-up, normal operation, and after pump shut-off. Stand clear of circulation system equipment during pump start-up. Failure to follow safety and operation instructions could result in violent separation of the pump housing and cover due to pressure in the system, which could cause property damage, severe personal injury, or death. Before servicing pool water circulation system, all system and pump controls must be in off position and filter manual air relief valve if part of the filtration system must be in open position. Before starting system pump, all system valves must be set in a position to allow system water to return back to the pool. Do not change filter control valve position while system pump is running. Before starting system pump, fully open filter manual air relief valve. Do not close filter manual air relief valve until a steady stream of water (not air or air and water) is discharged. All suction and discharge valves **MUST** be **OPEN** when starting the circulation system.

Failure to do so could result in severe personal injury and/or property damage.

WARNING – Separation Hazard.

Failure to follow safety and operation instructions could result in violent separation of pump components. Strainer cover must be properly secured to pump housing with strainer cover lock ring. Before servicing pool and spa circulation system, all system and pump controls must be in off position and filter manual air relief valve must be in open position. Do not operate pool circulation system if a system component is not assembled properly, damaged, or missing. Do not operate pool circulation system unless filter air relief valve body is in closed position. All suction and discharge valves **MUST** be **OPEN** when starting the circulation system.

Failure to do so could result in severe personal injury and/or property damage.

WARNING – Never operate or test the circulation system at more than 40 PSI.

WARNING – Fire and burn hazard.

Motors operate at high temperatures and if they are not properly isolated from any flammable structures or foreign debris they can cause fires, which may cause severe personal injury or death. It is also necessary to allow the motor to cool for at least 20 minutes prior to maintenance to minimize the risk for burns.

WARNING – Failure to install according to defined instructions may result in severe personal injury or death.

WARNING - Use of unauthorized replacement parts voids warranty.

WARNING - This device complies with part 15 of the FCC Rules. Operation is subject to the following two conditions:

(1) This device may not cause harmful interference, and (2) this device must accept any interference received, including interference that may cause undesired operation.

Caution: Changes or modifications to this unit not expressly approved by the party responsible for compliance could void the user's authority to operate the equipment.

NOTE: This equipment has been tested and found to comply with the limits for a Class A digital device, pursuant to part 15 of the FCC Rules. These limits are designed to provide reasonable protection against harmful interference when the equipment is operated in a commercial environment. This equipment generates, uses, and can radiate radio frequency energy and, if not installed and used in accordance with the instruction manual, may cause harmful interference to radio communications. Operation of this equipment in a residential area is likely to cause harmful interference in which case the user will be required to correct the interference at his own expense.

To satisfy RF exposure requirements, a separation distance of 20 cm or more should be maintained between the antenna of this device and persons during device operation.

To ensure compliance, operations at closer than this distance is not recommended

WARNING – This product should be installed and serviced only by a qualified professional.

Pump Location

Locate pump as close to pool as practical and run suction lines as direct as possible to reduce friction loss. Suction lines should have continuous slope upward from lowest point in line. Joints must be tight (but not over-tightened). Suction line diameter must equal or be larger than the discharge line diameter.

Though the pump is designed for outdoor use, it is strongly advised to protect the electrical components from the weather. Select a well-drained area, one that will not flood when it rains. **Do NOT install pump in a damp or non-ventilated location.** Keep motor clean.

Pump Mounting

Install pump on a firm, level base or pad to meet all local and national codes. Fasten pump to base or pad with screws or bolts to further reduce vibration and stress on pipe or hose joints. The base **MUST** be solid, level, rigid, and vibration free.

Pump installation should:

- Allow pump inlet height to be as close to water level as possible for installations.
- Allow use of short, direct intake pipe or hose (to reduce friction losses).
- Allow for gate valves in intake and discharge pipes for installations.
- Be protected from excess moisture and flooding.
- Allow adequate access for servicing pump and plumbing.
- Installation of union fittings in front of the pump intake and between the pump outlet and tank is highly recommended for use with in ground pools.

Pipe Sizing Chart

MAXIMUM RECOMMENDED SYSTEM FLOW RATE BY PIPE SIZE FOR SMP7502EWW	
Pipe Size	Flow rate
[mm]	m ³ /h[Liter/Min]
2"	21
[50]	[350]

NOTE - It is recommended that a minimum length of piping, equivalent to 10 pipe diameters, be used between the pump suction inlet and any plumbing fittings.

WARNING – Hazardous Pressure.

Pumps, filters, and other equipment/ components of a swimming pool filtration system operate under pressure. Incorrectly installed and/or improperly tested filtration equipment and/or components may fail resulting in injury and/or property damage.

Plumbing

Use “Teflon” tape, available at any plumbing or hardware store, to seal threaded connections on molded plastic components. All plastic fittings must be new or thoroughly cleaned before use. **NOTE - Do NOT use Plumber’s Pipe Dope as it may cause cracking of the plastic components.** When applying “Teflon” tape to plastic threads, wrap the entire threaded portion of the male fitting with one to two layers of tape. Wind the tape clockwise as you face the open end of the fitting, beginning at the end of the fitting. The pump suction and outlet ports have molded-in thread stops. **Do NOT attempt to force hose connector fitting**

past this stop. It is only necessary to tighten fittings enough to prevent leakage. Tighten fitting by hand and then use a tool to engage fitting an additional 1 ½ turns. Use care when using Teflon tape as friction is reduced considerably; **Do NOT over-tighten fitting or you may cause damage.** If leaks occur, remove fitting, clean off old Teflon tape, re-wrap with one to two additional layers of Teflon tape, and re-install fitting. See the Trouble Shooting section for additional solutions.

Fittings

Different pumps come with different type and size hose or plumbing fittings. Review the Technical Sections in this Owners / Installation manual to insure you have the correct fitting before starting installation. If your new pump is replacing an older pump it may be necessary to find specialized plumbing fitting to make the plumbing connections. Check with your local pool professional store or a well-equipped hardware store to find what you need.

Fittings restrict flow. For better efficiency, use the fewest possible fittings (but at least two suction outlets). Avoid fittings that could cause an air trap. Use a non-entrapping suction fitting in pool (multiple drains) or double suction (skimmer and main drain).

Section #3, Electrical & Wiring

WARNING – Ground and bond motor before connecting to electrical power supply. Failure to ground and bond pump motor can cause serious or fatal electrical shock hazard. See Grounding and Bonding instructions.

WARNING – Do NOT ground to a gas supply line.

WARNING – To avoid dangerous or fatal electrical shock, turn OFF power to motor before working on electrical connections.

WARNING – Ground Fault Circuit Interrupter (GFCI) tripping indicates electrical problem. If GFCI trips and won't reset, consult electrician to inspect and repair electrical system.

WARNING – Fire Hazard.

Match supply voltage to motor nameplate voltage.

Insure that the electrical supply available agrees with the motor's voltage, phase, and cycle, and that the wire size is adequate for the H.P. (KW) rating and distance from the power source. **NOTE - All electrical wiring MUST be performed by a licensed electrician, and MUST conform to local codes.** Use copper conductors only.

Voltage

Voltage at motor **MUST NOT** be more than 10% above or below motor name plate rated voltage, or motor may overheat, causing overload tripping and reduced component life. If voltage is less than 90% or more than 110% of rated voltage when motor is running at full load, consult Power Company.

Grounding and Bonding

Install, ground, bond, and wire motor in accordance with local or national electrical code requirements.

Permanently ground motor. Use green ground terminal provided under motor canopy or access place; use size and type wire required by code. Connect motor ground terminal to electrical service ground. Bond motor to pool structure. Bonding will connect all metal parts within and around the pool with a continuous wire.

Bonding reduces the risk of a current passing between bonded metal objects, which could potentially cause electrical shock if grounded or shorted.

Section #4, Start-Up & Operation

Prior to Start-Up

Notice: If it is necessary to perform a pressure test, prior to initial use to ensure pump is functioning properly, then the following criteria should be maintained for this test:

1. Have a professional perform this test.
2. Ensure all pump and system components are sealed properly to prevent leaks.
3. Remove any trapped air in the system by fully opening filter manual air relief valve until a steady stream of water is discharged.
4. Allow no more than 40 psi (276 kPa) at a water temperature no higher than 50C⁰.
5. Run pressure test for no longer than 24 hours. Immediately inspect all parts to verify they are intact and functioning properly. Fill strainer housing with water to suction pipe level. **NEVER OPERATE THE PUMP WITHOUT WATER.** Water acts as a coolant and lubricant for the mechanical shaft seal.

WARNING – If pump is being pressure tested (40 PSI MAXIMUM), be sure pressure has been released before removing strainer cover.

CAUTION – NEVER run pump dry. Running pump dry may damage seals, causing leakage, flooding, and voids warranty. Fill strainer housing with water before starting motor.

ATTENTION – Do NOT add chemicals to pool system through the skimmer (if pool is so equipped) or directly in front of pump suction. Adding undiluted chemicals may damage pump and voids warranty.

ATTENTION – Before removing strainer cover:

1. **STOP PUMP** before proceeding.
2. **CLOSE VALVES** in intake and outlet pipes if part of the pump installation.
3. **RELEASE ALL PRESSURE** from pump and piping system using filter manual air relief valve. **See filter owner's manual for more detail.**

Priming Pump

CAUTION – All suction and discharge valves **MUST** be **OPEN**, as well as filter air relief valve (if available) on filter, when starting the circulating pump system. Failure to do so could result in severe injury.

- Release all pressure from filter, pump, and piping system. **See filter owner's manual.**
- If water source is higher than the pump as is normal with Above Ground installations, pump will prime itself when suction and outlet valves are opened.
- If water source is lower than the pump as is normal with In Ground installations, unscrew and remove strainer cover; fill strainer housing with water.
- Clean and lubricate strainer cover O-ring with high quality O-ring lubricant each time it is removed.
- Inspect O-ring and re-install on strainer cover if damaged.
- Replace strainer cover on strainer housing; turn clockwise to tighten cover.
- **NOTE - Tighten strainer cover by hand only (no wrenches).**

Turn on power and wait for pump to prime, which may take up to five (5) minutes. Priming time will depend on vertical length of suction lift and horizontal length of suction pipe. If pump does NOT prime within five minutes, stop motor and determine cause. Be sure all suction and discharge valves are open when pump is running. See Troubleshooting Guide.

ATTENTION – Wait five (5) seconds before re-starting pump.

Failure to do so may cause reverse rotation of motor and consequent serious pump damage.

Close filter manual air relief valve after pump is primed.

Section #5, Programing Variable Time & Speed Functions

Follow the programming steps in this section carefully. Take your time so you complete the programming successfully the first time. It is helpful to have a second person to read the programming steps from the manual as you enter the values with the operation buttons.

“starmatrix” APP control:



- 1) Download the “starmatrix” APP from APP store.
- 2) Log in the starmatrix APP and connect the pump.
 - Wifi connection
Press “Add a device” and then connect the pump under APP guidance.
 - Bluetooth connection
Press “Add Bluetooth device” and then connect the pump under APP guidance.
Attention: if you connect the pump only in Bluetooth, then you can only control your pump by Bluetooth, if you want to control it by Wifi, then repeat the “Wifi connection” guidance.
- 3) **APP MANU mode:**
 - There are four default speed settings:”LOW”, “MEDI”, “HIGH” and “FULL”, press the ON/OFF button on your phone and then you can change the pump motor speed quickly with these four settings.
 - Also you can press “+” or “-” to change the pump speed.
- 4) **APP AUTO mode:**

NOTE - Automatic Mode will not function until Start Time and End time and Running Speed Parameters are programed. Follow the instructions below to program Start Time and End time and Running Speed for each segment.

 - Firstly press ON/OFF and then open the switch on the segment you want to set.
 - Press the segment to set the Start Time, End time and Running Speed and press save.

Display Control:

A. Operating modes:

These pumps have two operationg modes: Manual and Automatic. You can switch back and forth for your preferred operating mode. To switch between modes, press the “UP” and “DOWN” buttons at the same time.

1.0) Manual Operating mode:



(Image #1)

In Manual Mode the pump runs at the constant speed set by the user. (See Image #1)

1.1) Manual mode has four default speeds : “LOW”, “MEDIUM”, “HIGH”, “FULL”

	LOW	MEDI	HIGH	FULL
Lowest Speed	1150	1150	1150	1150
Highest Speed	2850	2850	2850	2850
Default Speed	1150	1700	2100	2850

1.2) The default speeds can not be changed. However, you can adjust to a temporary pump speed within a default settings with the “UP” or “DOWN” buttons.

1.3) Once you have the temporary speed set as desired press the “SET” button to adjust to next default speed.

1.4) In Manual mode, if you turn off the pump, the current speed can be auto-saved when you use the pump next time.

2.0) Automatic Operating mode: To start Automatic Mode Programming press “SET” once (See Image #2).

NOTE - Automatic Mode will not function until Current Time and Times & Speeds Parameters are programmed. Follow the instructions below to program Current Time and the Times & Speeds Parameters for each segment.

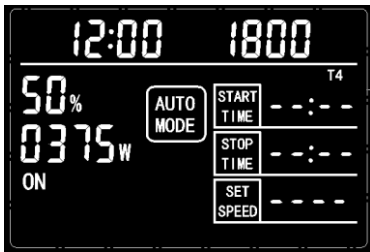

(Image #2)

2.1) Program Current Time:

- To set Current Time press the “RUN/STOP” and “SET” button at the same time, hold for 3 seconds. The hour setting will flash. Use the UP or Down buttons to adjust to current hour. When you have the hour correct press the “SET” button once to move to minute setting. The minute setting will flash. Press the “UP” or “DOWN” button to adjust to the current minute (See Image #3).



(Image #3)

2.2) Program “T” Segment Times and Operating Speeds:

- A maximum of 4 timing segments can be programmed. Each timing segment includes three parameters: "Start Time", "End Time" and "Running Speed". The segments are shown on the screen as “T1”, “T2”, “T3” & “T4”. After setting, the pump runs at the speed programmed within the times set for Start and End. Times and speeds are saved when power is off.

- When programming times and speeds parameters for the first time, programming automatically starts with the first time and speed segment, “T1”.
- When programming a time and speed segment, all parameters (Start Time, End Time and Running Speed) are displayed. The parameter being programmed flashes.
- Press the “SET” button to start programming your “T1” operating time and speed segment. Use the “UP” or “DOWN” buttons to program the Start Time, End Time and Operating Speed. The parameter being set will flash. When you have the times or speed set as you want, press “SET” to save it. The next parameter will flash. Continue through the Start Time, End Time and Speed settings until finished. Once you have the first segment programmed press the “SET” button for 3 seconds to save and exit that segment.
- Press the “DOWN” button to move to the “T2” segment you wish to program. Repete the process used to program the 1st time and speed segment.
- Continue the process through “T3” & “T4” until you have programmed as many of the four available time and speed segments you wish. It is not necessary to program all four of the time and speed segments.
- If you make a mistake while you are programming time and speed in a segment you can go back by pressing “SET” once. Then switch to the time or speed setting you want to change by pressing “SET” until that setting flashes. Use the “UP” or “DOWN” buttons to change the setting.
- If during the process of programming a “T” segment you fail to press a button and more than 8 seconds elapses, the programming for that “T” segment will automatically save and exit. You can cycle back to that segment by pressing the “DOWN” button once then press the “SET” button until you come back to the segment you were programming. Proceed with the normal segment programming steps.
- When programming a “T2”, “T3” or T4” segments the programmed times may not overlap with times from other segments. If this happens the programming for that segment cannot be saved. Go back to restart that segment’s programming as explained above.
- To fast delete the current settings for “T” segment, set the hour in start time to “23” and press the “UP” button once, all the setting under this segment will be deleted. Or set the hour in start time to “00” and press the “Down” button once, all the setting under this segment will be deleted.
- Review the button fuctions below for additional programming information.

3.0)Button Descriptions and Functions:

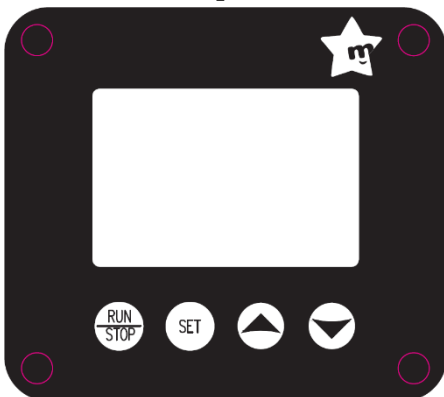

It is used to start or stop the pump.

- When switched to stop in the Manual Mode the pump stops until turned back on.
- When switched to stop in the Automatic Mode the pump automatically turns on when the time reaches the next programmed segment.

3.2) “SET” Button:

- In the Manual Mode, it is used to switch between different default speeds.
- In Automatic Mode, it is used to enter the programming status or enter the next item for programming in each segment.
- In Automatic Mode press and hold for 3 seconds to exit the segment.

3.3) “UP” Button:

- In Manual Mode, it can be used to increase the pump speed.
- When used during Current Time programming, users can cycle up to the previous interface to view the timing item page.
- When used in programming the Automatic Mode “T” segments, it is used to increase the time or speed in that segment.
- Pressing and holding will rapidly increase the change in value.

3.4) “DOWN” Button:

- In Manual Mode, it can be used to decrease the pump speed.
- When used during Current Time programming, users can cycle down to the previous interface to view the timing item page.
- When used in programming the Automatic Mode “T” segments, it is used to decrease the time or speed in that segment.
- Pressing and holding will rapidly decrease the change in value.

3.5) “Combination Button Functions:

- Press the "UP" and "DOWN" buttons at the same time to switch between "Automatic mode" and "Manual mode".
- Press the "RUN/STOP" button and "Set" button at the same time and hold for 3 seconds to set the current time. If you need to cancel the setting, press the "On / Off" button and "Set" button again to exit.

Maintenance

- Clean strainer basket regularly. Do NOT strike basket to clean. Inspect strainer cover gasket regularly and replace as necessary.
- Pumps have self-lubricating motor bearings and shaft seals. No lubrication is necessary.
- Keep motor clean. Do NOT use water to hose off motor.
- Occasionally, shaft seals must be replaced, due to wear or damage. Replace with genuine seal assembly kit.

Storage & Winterization

WARNING – Separation or Explosion Hazard.

- Do not purge the system with compressed air. Purging the system with compressed air can cause components to explode, with risk of severe injury or death to anyone nearby. Use only a low pressure (below 5 PSI), high volume blower when air purging the pump, filter, or piping.

ATTENTION – Allowing the pump to freeze will void the warranty.

ATTENTION – Use ONLY propylene glycol as antifreeze in your pool/spa system. Propylene glycol is nontoxic and will not damage plastic system components; other anti-freezes are highly toxic and may damage plastic components in the system.

- Drain all water from pump and piping when expecting freezing temperatures or when storing pump for a long time (see instructions below).
- Keep pump dry and covered during storage. To avoid condensation/corrosion problems, do NOT cover or wrap pump with plastic film or bags.

Storing Pump for Winterization

WARNING – To avoid dangerous or fatal electrical shock hazard, turn OFF power to motor before draining pump. Failure to disconnect power may result in serious personal injury or death.

- Drain water level below all inlets to the pool.
- Remove drain plugs from bottom of strainer body, and remove strainer cover from strainer housing.
- Disconnect pump from mounting pad, wiring system and plumbing system.
- Once the pump is empty of water, re-install the strainer cover and drain plugs. Store pump in a dry area.

Section #7, TECHNICAL DATA for SMP7502EW

VARIABLE SPEED SWIMMING Pool Pumps

MODEL #s SMP7502EW

ST No.	Input Power	WEF	Voltage	Hertz	HHP	Max Flow Rate	Wire Size
SMP7502EW	750W	10.34	230V	50Hz	0.533	21 m3/H	H07RN-F

MODEL #s SMP7502EW

PUMP PARTS

1. Pumps Parts Breakdown & Diagram

MODEL#s: SMP7502EW

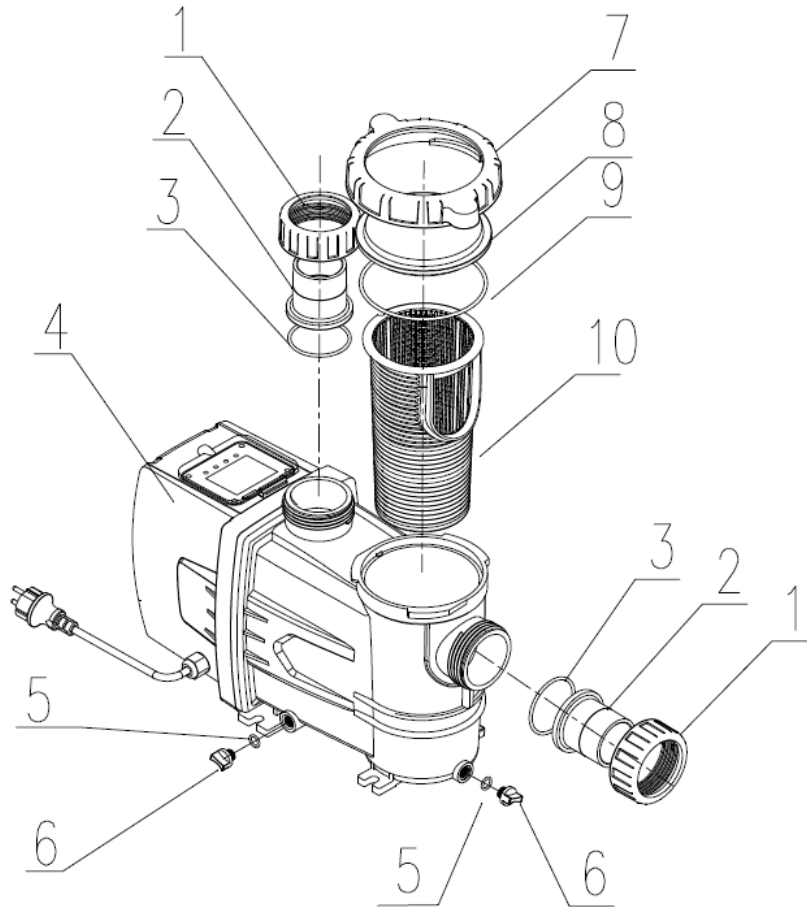

Key	Part Name	QTY	Mnfg NO.	SM. No.	For Model#
1	Plastic Nut	2	SM2101	SM2101	SMP7502EW

2	Hose Coupling 2"	2	SM2102	SM2102	SMP7502EW
3	O-ring	2	SM2103	SM2103	SMP7502EW
4	Motor Shell	1	SM2104	SM2104	SMP7502EW
5	O-ring	2	SM2105	SM2105	SMP7502EW
6	Drain Valve	2	SM2106	SM2106	SMP7502EW
7	Screw Cap	1	SM2107	SM2107	SMP7502EW
8	Transparent Cover	1	SM2108	SM2108	SMP7502EW
9	O-ring	1	SM2109	SM2109	SMP7502EW
10	Filter Basket	1	SM2110	SM2110	SMP7502EW

Section #8, Trouble Shooting for SMP7502EW Pumps

Computer Controlled Trouble Shooting Features for SMP7502EW Pumps:

1. High or Low Temperature Protection

When the motor temperature is higher than 90°C or is lower than -5°C, The pump will stop and the error code TP is displayed. When normal motor temperature is restored, between 5°C to 60°C, The pump will start automatically according to user's automatic mode programming.

2. Blocking or Jamming Protection

When the motor impeller or the motor is stuck, the error code BP is displayed. The pump will automatically attempt to restart in 6 seconds. If restarting does not happen automatically after several attempts users need to check the impeller and motor. Always turn off power before attempting maintenance.

3. Voltage Overload Protection

When the controller has a fault such as over load or over current, the error code OL is displayed. The pump tries to restart in 6 seconds automatically if the pump is not damaged.





4. Phase-Loss Protection

When the main PCB detects a phase loss problem (e.g.the motor cable is not properly connected), the error code LP is displayed. The pump will try to restart automatically in 6 seconds after the cable is reconnected or the phase loss is resolved.

5. Communication Loss Protection

When a communication failure occurs between the display PCB and the main PCB inside the pump, the error code CP is displayed and pump stops.

Fault Codes, Causes & Solutions

Code	Fault	Display	Possible causes	Solution
TP	High temperature or Low temperature protection		Temperature higher than 90°C or temperature lower than -5°C	1. Wait for the temperature to return to normal 5°C to 60°C.
BP	The motor impeller or the motor will not turn		1. Pump sucked in impurities and the impeller is jammed; 2. Bearing damage froze the motor shaft.	1. The pump will attempt restart in 6 seconds automatically. If restarting fails users need to check the impeller and motor with power off. 2. Send it to a professional repair station for repair.
OL	Voltage Over load		The output amper is too high.	1. The pump will try to restart in 6 seconds automatically if it is not damaged. 2. Send it to a professional repair station for repair.
LP	Phase Loss		There is a phase wire missing connection at the input.	1. The pump will try to restart automatically in 6 seconds after the phase wire is well connected.
CP	Communication Failure		1. Loose connection cable between display PCB and main PCB; 2. Connection cable damaged.	1. After communication is restored, the pump will restart automatically. 2. Check the connection cable. 3. Send it to a professional repair station for repair.

Section #9, General Pool Pump Trouble Shooting Guidelines:

Motor Will NOT Start – Check For:

Make sure the terminal board connections agree with the wiring diagram on motor data plate label. Be sure motor is wired for available field supply voltage (see pump operating label).

1. Improper or loose wiring connections; open switches or relays; tripped circuit breakers, GFCI's, or blown fuses.

Solution: Check all connections, circuit breakers, and fuses. Reset tripped breakers or replace blown fuses.

2. Manually check rotation of motor shaft for free movement and lack of obstruction.
3. If you have a timer, be certain it is working properly. Bypass it if necessary.

Motor Shuts OFF – Check For:

1. Low voltage at motor or power drop (frequently caused by undersized wiring or extension cord use).

Solution: Contact qualified professional to check that the wiring gauge is heavy enough.

2. Motor may be overheating due to direct sunlight or low water level in the pump basket.

Solution: Check water flow to insure uniform amount of water coming to the pump.

NOTE - Your pump motor is equipped with an “automatic thermal overload protector.” The motor will automatically shut off if power supply drops before heat damage can build up causing windings to burn out. The “thermal overload protector” will allow the motor to automatically restart once the motor has cooled. It will continue to shut off until the problem is corrected. **Be sure to correct cause of overheating.**

Motor Hums, But Does NOT Start – Check For:

1. Impeller jammed with debris.

Solution: Have a qualified repair professional open the pump and remove the debris.

2. Motor is frozen either from months in the carton after manufacturing or from over winter storage.

Solution: Insert a flat bladed screw driver into the slot at the back end of the motor shaft and turn motor shaft until it moves freely. You may have to remove the protective metal cap from some models to access the motor shaft.

NOTE – All SMP7502EW pumps are run tested with water before leaving the factory.

Pump Won't Prime - Check For:

1. Empty pump/strainer housing

Solution: Make sure pump/strainer housing is filled with water and cover o-ring is clean. Ensure o-ring is properly seated in the cover o-ring groove. Ensure o-ring is lubricated and that strainer cover is locked firmly in position. Lubricant will help to create a tighter seal.

2. Loose connections on suction side.

Solution: Tighten pipe/union connections or hose clamps on flexible hose.

NOTE - Any self-priming pump will not prime if there are suction air leaks. Leaks will result in bubbles emanating from return fittings on In Ground pool wall.

3. Leaking O-ring on valves.

Solution: Tighten, repair, or replace valves.

4. Strainer basket or skimmer basket loaded with debris.

Solution: Remove strainer housing cover or skimmer cover, clean basket, and refill strainer housing with water. Tighten cover.

5. Suction side In Ground pool intake plumbing clogged.

Solution: Contact a qualified repair professional to do a vacuum test.

Block off to determine if pump will develop a vacuum. You should have 5”-6” of vacuum at the strainer cover (**Only your**

pool dealer can confirm this with a vacuum gauge). You may be able to check by removing the skimmer basket and holding your hand over the bottom port with skimmer full and pump running. If no suction is felt, check for line blockage.

- a. If pump develops a vacuum, check for blocked suction line or dirty strainer basket. An air leak in the intake plumbing may be the cause.
- b. If pump does not develop a vacuum and pump has sufficient “priming water”:
 - i. Re-check strainer housing cover and all threaded connections for suction leaks. Check and tighten all system hose clamps on Above Ground pools.
 - ii. Check voltage to ensure that the motor is running at full RPM’s.
 - iii. Open housing cover and check for clogging or obstruction in suction. Check impeller for debris.
 - iv. Remove and replace shaft seal only if it is leaking.

Low Flow – Generally, Check For:

1. Clogged or restricted strainer or suction line.

Solution: Check for visible debris and remove if observed. If the problem continues contact a qualified repair professional.

2. Undersized pool plumbing.

Solution: Correct plumbing size.

3. Plugged or restricted discharge line of filter, valve partially closed (high gauge reading).

Solution: Sand filters – backwash as per manufacturer’s instructions; D.E. filters – backwash as per manufacturer’s instructions; Cartridge filters – clean or replace cartridge.

4. Air leak in suction (bubbles issuing from return fittings).

Solution: Re-tighten suction and discharge connections using Teflon tape. Inspect other plumbing connections and tighten as required.

5. Plugged, restricted, or damaged impeller.

Solution: Contact a qualified repair professional to install a new impeller & seal assembly.

Noisy Pump – Check For:

1. Air leak in suction piping, cavitation caused by restricted or undersized suction line or leak at any joint, low water level in pool, and unrestricted discharge return lines.

Solution: Correct suction condition or tighten fittings, if practical. Holding hand over return fitting will sometimes prove this point or putting in a smaller return eyeball fitting.

2. Vibration due to improper mounting, etc.

Solution: Mount the pump on a level surface and secure the pump to the equipment pad.

3. Foreign matter in pump housing. Loose stones/debris hitting impeller will cause noise.

Solution: With the pump turned off or disconnected from the power source clean the pump housing and inspect to remove any debris visible in the inner portion of the pump by the impeller.

4. Motor bearings noisy from normal wear, rust, overheating, or concentration of chemicals causing seal damage. This will allow chlorinated water to seep into bearings wiping out the grease resulting in rusting of the motor shaft and causing the bearing to whine.

Solution: All seal leaks must be replaced at once. Have a qualified pump repair specialist replace the motor shaft seals and inspect the motor shaft for possible damage. If the motor shaft is damaged replace the motor.

Water Leaks Around Intake and Discharge fittings – Check For

1. Lose union fittings or hose fittings.

Solution: Tighten fittings or remove, apply Teflon tape and reinstall.

2. Lose hose clamps on flexible hose.

Solution: Tighten hose clamps using a nut driver or wrench instead of a screwdriver

3. Leaks that continue after trying the above solutions.

Solution: Inspect union fittings and hose fittings for excess plastic mold flashing that can cause hoses and plumbing not to seal. If plastic mold flashing is found remove it with a fine tooth file or knife blade and re-assemble. If the fitting still will not seal replace them and reassemble plumbing with the new fittings.

Section #10 – Warranty Information in English & French

This product is warranted to the original purchaser to be free from defects in material or workmanship for a period of one (1) year from the date of the original retail purchase.

This warranty does not cover defects or damage due to improper installation, alteration, accident or any other event beyond the control of the manufacturer. Defects or damage resulting from misuse, abuse or negligence will void this warranty. This warranty does not cover scratching or damage that may result from normal usage.

This product is not intended for institutional or commercial use; the manufacturer does not assume any liability for such use. Institutional or commercial use will void this warranty.

This warranty is nontransferable and is expressly limited to the repair or replacement of the defective product. During the warranty period, the manufacturer shall repair or replace defective parts at no cost to the purchaser. Shipping charges and insurance are not covered and are the responsibility of the purchaser. Labor charges and related expenses for removal, installation or replacement of the product or components are not covered under this warranty.

The manufacturer reserves the right to make substitutions to warranty claims if parts are unavailable or obsolete.

The manufacturer shall not be liable for loss of use of the product or other consequential or incidental costs, expenses or damages incurred by the consumer of any other use. The user assumes all risk of injury resulting from the use of this product.

This warranty is expressly in lieu of all other warranties, expressed or implied, including warranties of merchantability or fitness for use to the extent permitted by Federal or state law.

Neither the manufacturer nor any of its representatives assumes any other liability in connection with this product.

All warranty claims must include the retailer's information where the product was originally purchased. A purchase receipt or other proof of date of purchase will be required to process all warranty claims. The model number and part numbers found within the assembly instructions will be required when submitting any parts requests or warranty claims.

For further warranty information or inquiries, please email

matrix@starmatrix.cn

STARMATRIX GROUP INC.