

## FCC TEST REPORT

For

Enping Yinyin Intelligent Technology Co., Ltd.

Microphone

Test Model: EW100

Additional Model No.: Please Refer to Page 6

Prepared for : Enping Yinyin Intelligent Technology Co., Ltd.  
Address : Second Floor, No. C5-2 (Workshop 2), Area 2, Enping Park, Jiangmen Industrial Transfer Industrial Park Encheng City, Enping, Guangdong China

Prepared by : Shenzhen LCS Compliance Testing Laboratory Ltd.  
Address : 101, 201 Bldg A & 301 Bldg C, Juji Industrial Park Yabianxueziwei, Shajing Street, Baoan District, Shenzhen, 518000, China

Tel : (+86)755-82591330  
Fax : (+86)755-82591332  
Web : www.LCS-cert.com  
Mail : webmaster@LCS-cert.com

Date of receipt of test sample : January 16, 2024  
Number of tested samples : 2  
Sample No : A240110074-1, A240110074-2  
Serial number : Prototype  
Date of Test : January 16, 2024 ~ February 03, 2024  
Date of Report : February 03, 2024





FCC TEST REPORT
FCC CFR 47 PART 74

Report Reference No. : LCSA01164102EA

Date of Issue : February 03, 2024

Testing Laboratory Name : Shenzhen LCS Compliance Testing Laboratory Ltd.

Address : 101, 201 Bldg A & 301 Bldg C, Juji Industrial Park Yabianxueziwei, Shajing Street, Baoan District, Shenzhen, 518000, China

Testing Location/ Procedure : Full application of Harmonised standards
Partial application of Harmonised standards
Other standard testing method

Applicant's Name : Enping Yinyin Intelligent Technology Co., Ltd.

Address : Second Floor, No. C5-2 (Workshop 2), Area 2, Enping Park, Jiangmen Industrial Transfer Industrial Park Encheng City, Enping, Guangdong China

Test Specification

Standard : FCC CFR 47 PART 74

Test Report Form No. : LCSEMC-1.0

TRF Originator : Shenzhen LCS Compliance Testing Laboratory Ltd.

Master TRF : Dated 2011-03

Shenzhen LCS Compliance Testing Laboratory Ltd. All rights reserved.

This publication may be reproduced in whole or in part for non-commercial purposes as long as the Shenzhen LCS Compliance Testing Laboratory Ltd. is acknowledged as copyright owner and source of the material. Shenzhen LCS Compliance Testing Laboratory Ltd. takes no responsibility for and will not assume liability for damages resulting from the reader's interpretation of the reproduced material due to its placement and context.

EUT Description : Microphone

Trade Mark : G-MARK

Test Model : EW100

Ratings : DC 3.0V by 2\*AA Batteries

Result : Positive

Compiled by:

Joker.Hu

Joker Hu/ Administrator

Supervised by:

Cary Luo

Cary Luo/ Technique principal

Approved by:

Gavin Liang

Gavin Liang/ Manager





### FCC -- TEST REPORT

<b>Test Report No. :</b> LCSA01164102EA	<u>February 03, 2024</u> Date of issue
---	---

Test Model..... : EW100

EUT..... : Microphone

**Applicant..... : Enping Yinyin Intelligent Technology Co., Ltd.**

Address..... : Second Floor,No. C5-2 (Workshop 2),Area 2,Enping  
Park,Jiangmen Industrial Transfer Industrial Park Encheng City,  
Enping, GuangDong China

Telephone..... : /

Fax..... : /

**Manufacturer..... : Enping Yinyin Intelligent Technology Co., Ltd.**

Address..... : Second Floor,No. C5-2 (Workshop 2),Area 2,Enping  
Park,Jiangmen Industrial Transfer Industrial Park Encheng City,  
Enping, GuangDong China

Telephone..... : /

Fax..... : /

**Factory..... : Enping Yinyin Intelligent Technology Co., Ltd.**

Address..... : Second Floor,No. C5-2 (Workshop 2),Area 2,Enping  
Park,Jiangmen Industrial Transfer Industrial Park Encheng City,  
Enping, GuangDong China

Telephone..... : /

Fax..... : /

<b>Test Result</b>	<b>Positive</b>
--------------------	-----------------

The test report merely corresponds to the test sample.

It is not permitted to copy extracts of these test result without the written permission of the test laboratory.





### Revision History

Revision	Issue Date	Revision Content	Revised By
000	February 03, 2024	Initial Issue	--



Shenzhen LCS Compliance Testing Laboratory Ltd.  
Add: 101, 201 Bldg A & 301 Bldg C, Juji Industrial Park Yabianxueziwei, Shajing Street, Baoan District, Shenzhen, 518000, China  
Tel: +(86) 0755-82591330 | E-mail: webmaster@lcs-cert.com | Web: www.lcs-cert.com  
Scan code to check authenticity



# TABLE OF CONTENTS

- 1. GENERAL INFORMATION ..... 6**
  - 1.1. DESCRIPTION OF DEVICE (EUT) ..... 6
  - 1.2. SUPPORT EQUIPMENT LIST ..... 7
  - 1.3. EXTERNAL I/O CABLE ..... 7
  - 1.4. DESCRIPTION OF TEST FACILITY ..... 7
  - 1.5. STATEMENT OF THE MEASUREMENT UNCERTAINTY ..... 8
  - 1.6. MEASUREMENT UNCERTAINTY ..... 8
  - 1.7. DESCRIPTION OF TEST MODES ..... 8
  - 1.8. FREQUENCY OF CHANNELS ..... 8
- 2. TEST METHODOLOGY ..... 9**
  - 2.1. EUT CONFIGURATION ..... 9
  - 2.2. EUT EXERCISE ..... 9
  - 2.3. GENERAL TEST PROCEDURES ..... 9
- 3. SYSTEM TEST CONFIGURATION ..... 10**
  - 3.1. JUSTIFICATION ..... 10
  - 3.2. EUT EXERCISE SOFTWARE ..... 10
  - 3.3. SPECIAL ACCESSORIES ..... 10
  - 3.4. BLOCK DIAGRAM/SCHEMATICS ..... 10
  - 3.5. EQUIPMENT MODIFICATIONS ..... 10
  - 3.6. TEST SETUP ..... 10
- 4. SUMMARY OF TEST RESULTS ..... 11**
- 5. TEST RESULT ..... 12**
  - 5.1. TRANSMITTER OUTPUT POWER ..... 12
  - 5.2. OCCUPIED BANDWIDTH AND EMISSION MASK ..... 14
  - 5.3. TRANSMITTER UNWANTED EMISSIONS(RADIATED OR CONDUCTED) ..... 18
  - 5.5.FREQUENCY STABILITY ..... 33
  - 5.6.MODULATION CHARACTERISTICS ..... 36
  - 5.7.NECESSARY BANDWIDTH (BN) FOR ANALOGUE SYSTEMS ..... 38
- 6. LIST OF MEASURING EQUIPMENTS ..... 40**
- 7. TEST SETUP PHOTOGRAPHS OF EUT ..... 41**
- 8. EXTERIOR PHOTOGRAPHS OF THE EUT ..... 41**
- 9. INTERIOR PHOTOGRAPHS OF THE EUT ..... 41**





# 1. GENERAL INFORMATION

## 1.1. Description of Device (EUT)

EUT : Microphone  
Test Model : EW100  
Additional Model No. G2.1IEM, G4.1IEM, G5.0 USB, G5.1IEM, G6.1IEM, G2000IEM, Studio 4, Studio 6, GM58, 4016D, GD10, GLC640, G6000promax, Micro Go, G7S, GDM7, KARAOKE 4, EM6050, SM57, SM58, E945, X333, X110V, G440XFM, EW100lavalier, GLXD4lavalier, G320AMLavalier, G1.1, G1.2, G1.3, G1.4, G1.5, G1.6, G1.7, G1.8, GX1.1, GX1.2, GX1.3, GX1.4, GX1.5, GX1.6, GX1.7, GX1.8, GA1.1, GA1.2, GA1.3, GA1.4, GA1.5, GA1.6, GA1.7, GA1.8, GM1.1, GM1.2, GM1.3, GM1.4, GM1.5, GM1.6, GM1.7, GM1.8, GD1.1, GD1.2, GD1.3, GD1.4, GD1.5, GD1.6, GD1.7, GD1.8, GD2.1, GD2.2, GD2.3, GD2.4, GD2.5, GD2.6, GD2.7, GD2.8, GD2.9, GD4.1, GD4.2, GD4.3, GD4.4, GD4.5, GD4.6, GD4.7, GD4.8, GX100, GX200, GX300, GX400, GX500, GX600, GX700, GX800, GK2.1, GK2.2, GK2.3, GK2.4, GK2.5, GK2.6, GK2.7, GK2.8, GL4.1, GL4.2, GL4.3, GL4.4, GL4.5, GL4.6, GL4.7, GL4.8, GP2.1, GP2.2, GP2.3, GP2.4, GP2.5, GP2.6, GP2.7, GP2.8, GO1.1, GO1.2, GO1.3, GO1.4, GO1.5, GO1.6, GO1.7, GO1.8, GO2.1, GO2.2, GO2.3, GO2.4, GO2.5, GO2.6, GO2.7, GO2.8, GS6.1, GS6.2, GS6.3, GS6.4, GS6.5, GS6.6, GS6.7, GS6.8, GB4.1, GB4.2, GB4.3, GB4.4, GB4.5, GB4.6, GB4.7, GB4.8, GC411, GDM8, DG7, G35D, G55D, G53C, G320AM, GLXD4, X320FM, G210V, X220U, X120V, SM7B, PGA48, PGA58, PGA57, PGA81, PGA181, PGA98H, PGASTUDIOKIT, PGA52, PGA56, PGA98D, PGADRUMKIT, SM27, SM48, BETA 58A, BETA 87A, BETA 87C, BETA 52A, BETA 56A, BETA 57A, BETA 91A, BETA 98AD/C, BETA 98H/C, BETA 98AMP, BETA 181, KSM8, KSM9, VP89, VP82, 565SD, E604, G1, G2, G3, G4, G5, G6, G7, G8, G9, e835, e845, e935, e925, e915, e825, e815, xs1, ew200, ew300, ew400, ew500, e965, KK1, SKM5000, SKM9000, SKM9200, SKM5200, XSW1, profile USB, MK4, MK5, MK6, E904, E906, E914, E608, E902, E901, E602, mke200, md435, md445, md421, The One, BC1200, TG DRUM SET, MC930, TG D70D, TG D50D, TG 153C, TG D58C, TG D57C, M70 PRO X, m80, m81, m90 pro x, mcm114, tF11, TF29, TF39, TF51, TF47, wa47 jr, EDGE SOLO, ELA M251E, 47 gold, EDGE NOTE, C12 VR, M92.1S, G8000, G8.1, SE7, se8, 2200, 2300, 4099, 4018, KMS105, KMS104, tlm103, u87ai, kk205, kk10, ku100, bcm70, m49, tlm102, u89i, tlm107, u47, sr318, sr314, m23, m30, m50, at2080, at2060, AT4047, X180, G440, G440XFM, G14S, G24S, G44S, G-MARK GO, G-MARK, GO pro, Go pro II, Go pro III, Go pro IV, Go pro V, Go 360, GD8, GD9, GD10, X440, X520, X720,, V001, GV002,



Shenzhen LCS Compliance Testing Laboratory Ltd.

Add: 101, 201 Bldg A & 301 Bldg C, Juji Industrial Park Yabianxueziwei, Shajing Street, Baoan District, Shenzhen, 518000, China

Tel: +(86) 0755-82591330 | E-mail: webmaster@lcs-cert.com | Web: www.lcs-cert.com

Scan code to check authenticity



G-X5-TVM, G-live, GLC440, GLC640, G4000-IEM, G5000-IEM, G6000-IEM, G820, Wireless GO, K8, K7, POP6, POP4, K9, M, GT400, IEM POCKET, C3000, G5.0USB

Model Declaration : PCB board, structure and internal of these model(s) are the same, So no additional models were tested

Power Supply : DC 3.0V by 2\*AA Batteries

Hardware Version : /

Software Version : /

UHF

Operation frequency : 520.1MHz-535.1MHz

Channel Number : 16 channels

Modulation Type : FM

Antenna Type : Internal Antenna

Antenna Gain : 0dBi

Extreme temp. Tolerance : -30°C to +50°C

1.2. Support Equipment List

Manufacturer	Description	Model	Serial Number	Certificate
--	--	--	--	--

1.3. External I/O Cable

I/O Port Description	Quantity	Cable
--	--	--

1.4. Description of Test Facility

NVLAP Accreditation Code is 600167-0.

FCC Designation Number is CN5024.

Test Firm Registration Number: 254912

CAB identifier is CN0071.

CNAS Registration Number is L4595.

Test Firm Registration Number: 254912.

The 3m-Semi anechoic test site fulfils CISPR 16-1-4 according to ANSI C63.4:2014 and CISPR 16-1-4:2010 SVSWR requirement for radiated emission above 1GHz.







### 1.5. Statement of the Measurement Uncertainty

The data and results referenced in this document are true and accurate. The reader is cautioned that there may be errors within the calibration limits of the equipment and facilities. The measurement uncertainty was calculated for all measurements listed in this test report acc. To CISPR 16 – 4 “Specification for radio disturbance and immunity measuring apparatus and methods – Part 4: Uncertainty in EMC Measurements” and is documented in the LCS quality system acc. To DIN EN ISO/IEC 17025. Furthermore, component and process variability of devices similar to that tested may result in additional deviation. The manufacturer has the sole responsibility of continued compliance of the device.

### 1.6. Measurement Uncertainty

Test Item	Frequency Range	Uncertainty	Note
Radiation Uncertainty	9KHz~30MHz	±3.10dB	(1)
	30MHz~200MHz	±2.96dB	(1)
	200MHz~1000MHz	±3.10dB	(1)
	1GHz~26.5GHz	±3.80dB	(1)
	26.5GHz~40GHz	±3.90dB	(1)
Conduction Uncertainty	150kHz~30MHz	±1.63dB	(1)
Power disturbance	30MHz~300MHz	±1.60dB	(1)

(1). This uncertainty represents an expanded uncertainty expressed at approximately the 95% confidence level using a coverage factor of k=2.

### 1.7. Description of Test Modes

The EUT has been tested under operating condition.

This test was performed with EUT in X, Y, Z position and the worst case was found when EUT in X position.

Worst-case mode and channel used for 150 kHz-30 MHz power line conducted emissions was the mode and channel with the highest output power, which was determined to be (HCH).

Worst-case mode and channel used for 9kHz-1000 MHz radiated emissions was the mode and channel with the highest output power, that was determined to be (HCH).

Worst-Case data rates were utilized from preliminary testing of the Chipset, worst-case data rates used during the testing are as follows:

Channel

Modulation Type	Test Channel	Test Frequency (MHz)
Channel	1	520.1
	8	527.1
	16	535.1

### 1.8. Frequency of Channels

Channel

Channel	Frequency (MHz)	Channel	Frequency (MHz)	Channel	Frequency (MHz)	Channel	Frequency (MHz)







1	520.1	5	524.1	9	528.1	13	532.1
2	521.1	6	525.1	10	529.1	14	533.1
3	522.1	7	526.1	11	530.1	15	534.1
4	523.1	8	527.1	12	531.1	16	535.1

## 2. TEST METHODOLOGY

All measurements contained in this report were conducted with ANSI C63.26-2015:American National Standard for Compliance Testing of Transmitters Used in Licensed Radio Services

The radiated testing was performed at an antenna-to-EUT distance of 3 meters. All radiated and conducted emissions measurement was performed at Shenzhen LCS Compliance Testing Laboratory Ltd.

### 2.1. EUT Configuration

The EUT configuration for testing is installed on RF field strength measurement to meet the Commissions requirement and operating in a manner that intends to maximize its emission characteristics in a continuous normal application.

### 2.2. EUT Exercise

The EUT was operated in the engineering mode to fix the TX frequency that was for the purpose of the measurements.

According to its specifications, the EUT must comply with the requirements of the Section FCC Rules Part 74.

### 2.3. General Test Procedures

#### 2.3.1 Power Line Conducted Emissions(N/A)

The EUT is placed on the turntable, which is 0.8 m above ground plane. According to the requirements in Section 6.2.1 of ANSI C63.4-2014 Conducted emissions from the EUT measured in the frequency range between 0.15 MHz and 30MHz using Quasi-peak and average detector modes.

#### 2.3.2 Radiated Emissions

please refer to radated spurioes emission





### 3. SYSTEM TEST CONFIGURATION

#### 3.1. Justification

The system was configured for testing in a continuous transmits condition.

#### 3.2. EUT Exercise Software

The system was configured for testing in a continuous transmits condition;and transmission frequency by switch button control.

#### 3.3. Special Accessories

N/A

#### 3.4. Block Diagram/Schematics

Please refer to the related document

#### 3.5. Equipment Modifications

Shenzhen LCS Compliance Testing Laboratory Ltd. has not done any modification on the EUT.

#### 3.6. Test Setup

Please refer to the test setup photo.



Shenzhen LCS Compliance Testing Laboratory Ltd.

Add: 101, 201 Bldg A & 301 Bldg C, Juji Industrial Park Yabianxueziwei, Shajing Street, Baoan District, Shenzhen, 518000, China

Tel: +(86) 0755-82591330 | E-mail: webmaster@lcs-cert.com | Web: www.lcs-cert.com

Scan code to check authenticity



#### 4. SUMMARY OF TEST RESULTS

Applied Standard: FCC Part 74		
FCC Rules	Description of Test	Result
FCC Part 74.861(e)(1)(ii) FCC Part 2.1046	Maximum Conducted Output Power	Compliant
FCC Part 74.861 (e)(5) FCC Part 2.1049	Occupied Bandwidth	Compliant
FCC Part 74.861 (e)(4) FCC Part 2.1055	Frequency error	Compliant
FCC Part 74.861(e)(6) 2.1053	Transmitter unwanted emissions(radiated or conducted)	Compliant
FCC Part 2.1049 FCC Part 2.1047	Modulation characteristic	Compliant
FCC Part 74.861 (e)(7) FCC Part 2.1049	Necessary bandwidth (BN) for analogue systems	Compliant



Shenzhen LCS Compliance Testing Laboratory Ltd.

Add: 101, 201 Bldg A & 301 Bldg C, Juji Industrial Park Yabianxueziwei, Shajing Street, Baoan District, Shenzhen, 518000, China

Tel: +(86) 0755-82591330 | E-mail: webmaster@lcs-cert.com | Web: www.lcs-cert.com

Scan code to check authenticity



## 5. TEST RESULT

### 5.1. Transmitter output power

#### 5.1.1. Measurement description:

The power may not exceed the following values.

- (i) 54-72, 76-88, and 174-216 MHz bands: 50 mW EIRP
- (ii) 470-608 and 614-698: 250 mW conducted power
- (iii) 600 MHz duplex gap: 20 mW EIRP

#### 5.1.2. Measurement:

Measurement parameter	
Detector:	Peak (worst case) / Average (RMS)
Sweep time:	Auto / 20s
Resolution bandwidth:	> emission bandwidth
Video bandwidth:	> resolution bandwidth
Span:	> 2 times emissions bandwidth
Trace mode:	Max. hold
EUT configuration:	Peak: Unmodulated carrier RMS: Modulate the transmitter with a 2.5 kHz tone at a level 16 dB higher than that required to produce a frequency deviation of $\pm 75$ kHz, or to produce 50% of the manufacturer's rated deviation, whichever is less.

#### 5.1.3. Limits:

FCC
470 MHz to 608 MHz 250 mW (average) / 24 dBm (average)

#### 5.1.4. Test result:

The EUT was programmed to be in continuously transmitting mode.





5.1.5. Test result

Channel

Test Mode	Frequency (MHz)	Measured Maximum Peak Power(dBm)	Measured Maximum Average Power(dBm)	Limits Average (dBm)	Verdict
FM	520.1	10.775	/	24	PASS
FM	527.1	10.870	/	24	PASS
FM	535.1	9.210	/	24	PASS

Maximum Peak Output Power

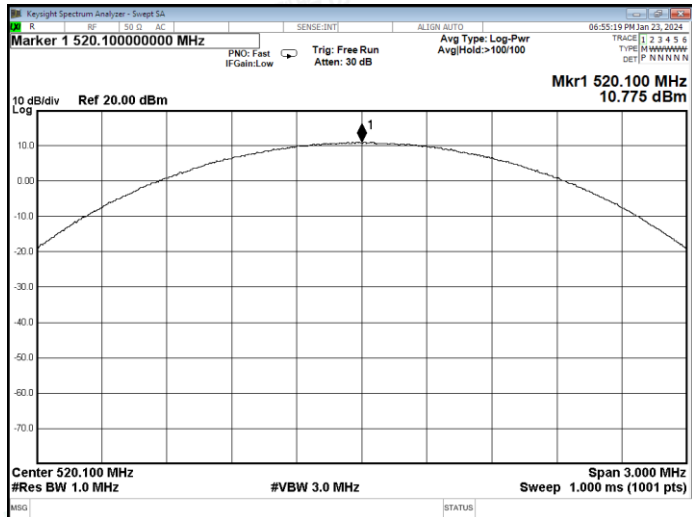

Channel 1 / 520.1 MHz

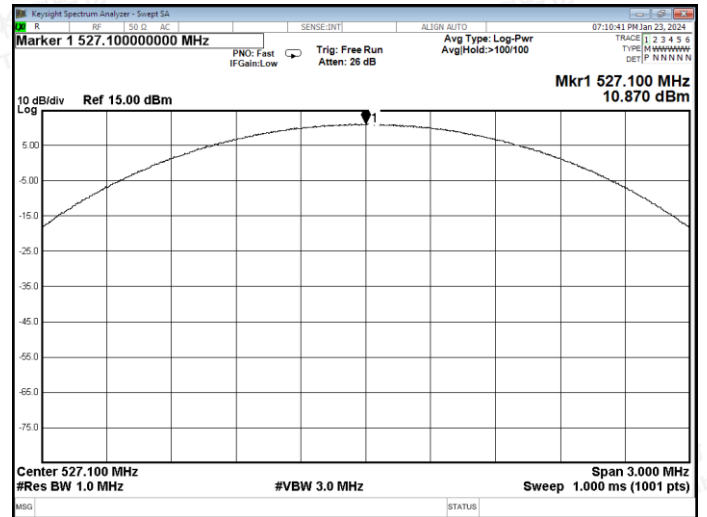

Channel 8 / 527.1 MHz

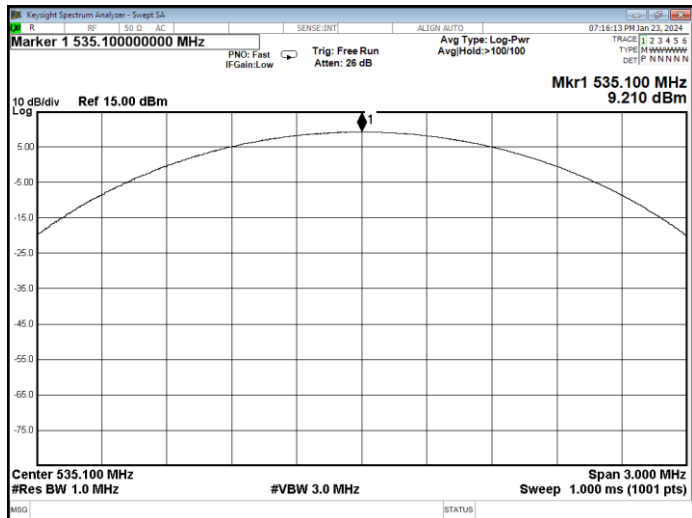

Channel 16 / 535.1 MHz





### 5.2. Occupied bandwidth and Emission Mask

#### 5.2.1. Measurement description:

The operating bandwidth shall not exceed 200 kHz.

The mean power of emissions shall be attenuated below the mean output power of the transmitter in accordance with the following schedule:

- (i) On any frequency removed from the operating frequency by more than 50 percent up to and including 100 percent of the authorized bandwidth: at least 25 dB;
- (ii) On any frequency removed from the operating frequency by more than 100 percent up to and including 250 percent of the authorized bandwidth: at least 35 dB;
- (iii) On any frequency removed from the operating frequency by more than 250 percent of the authorized bandwidth: at least  $43 + 10\log_{10}$  (mean output power in watts) dB.

#### 5.2.2. Measurement:

Measurement parameter	
Detector:	Peak
Sweep time:	Auto
Resolution bandwidth:	1 % to 5 % of the occupied bandwidth
Video bandwidth:	3 x resolution bandwidth
Span:	2 x emission bandwidth
Trace mode:	Max. hold
Analyzer function:	99% power occupied bandwidth function
EUT:	Modulated signal with max. frequency deviation

#### 5.2.3. Result:

##### Channel

Test Mode	Frequency (MHz)	99% Bandwidth (KHz)	Limits (KHz)	Verdict
FM	520.1	191.48	200	PASS
FM	527.1	191.30	200	PASS
FM	535.1	190.89	200	PASS







99% Bandwidth

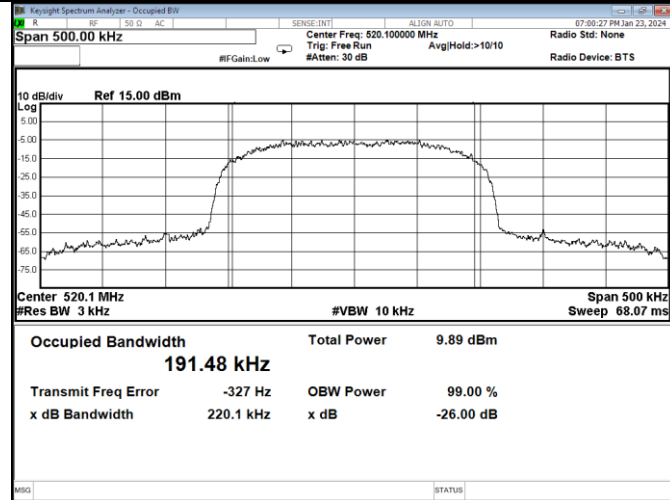

Channel 1 / 520.1 MHz

99% Bandwidth

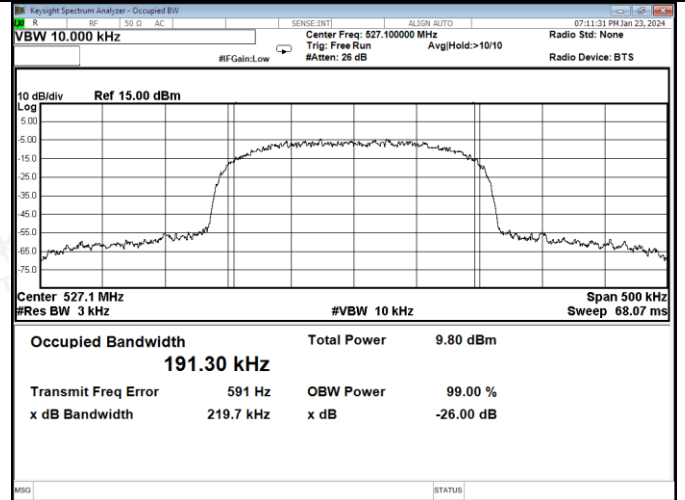

Channel 8 / 527.1 MHz

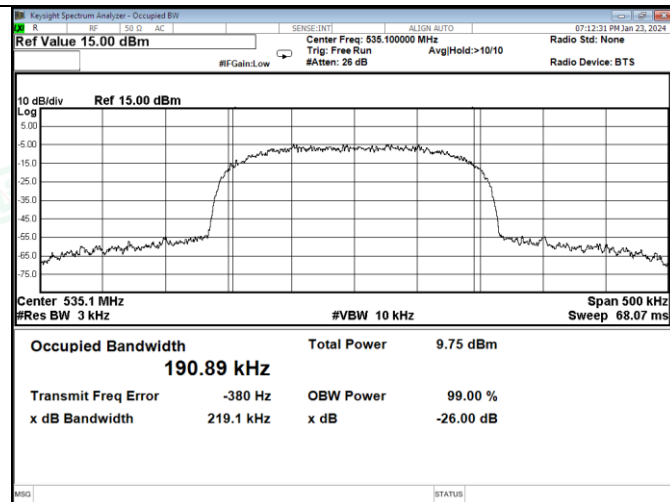

Channel 16 / 535.1 MHz





Spectrum mask

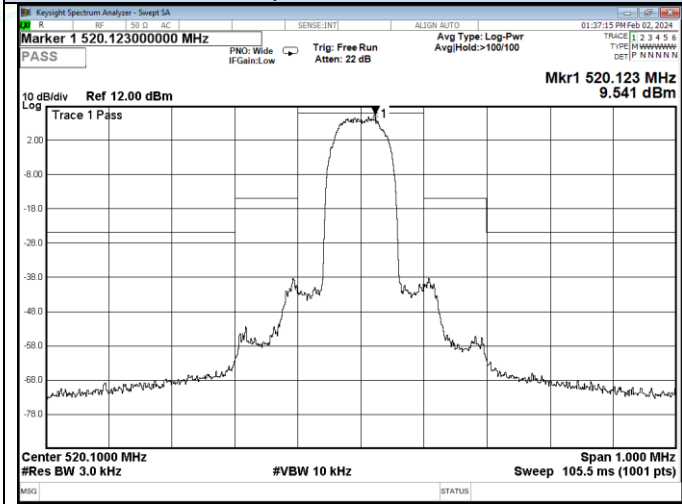

Channel 1 / 520.1 MHz

Spectrum mask

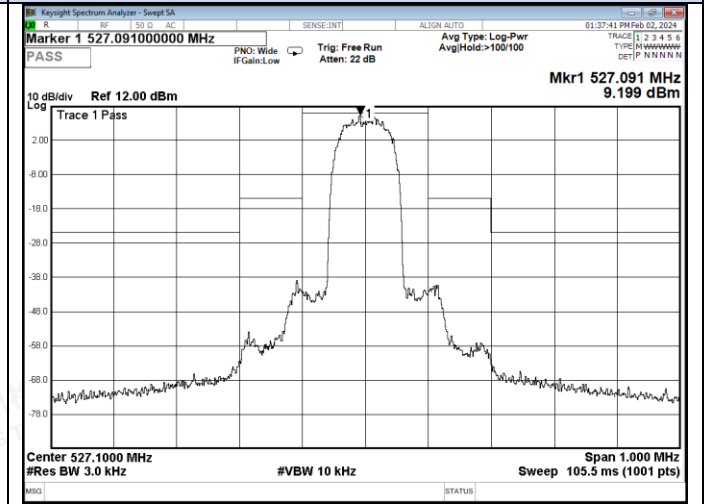

Channel 8 / 527.1 MHz

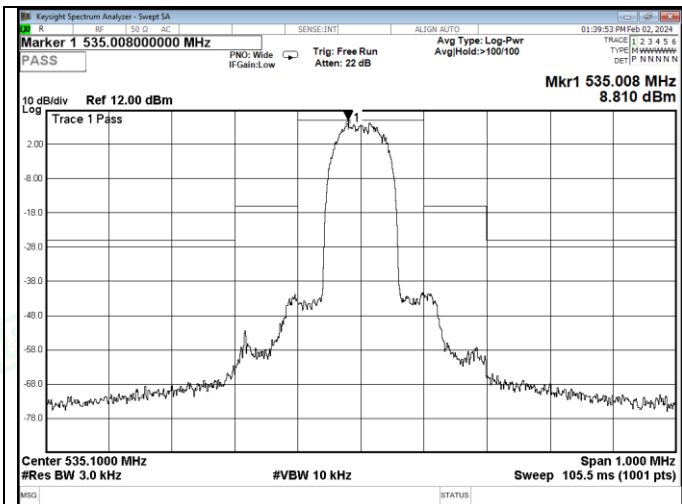

Channel 16 / 535.1 MHz





### spurious emissions

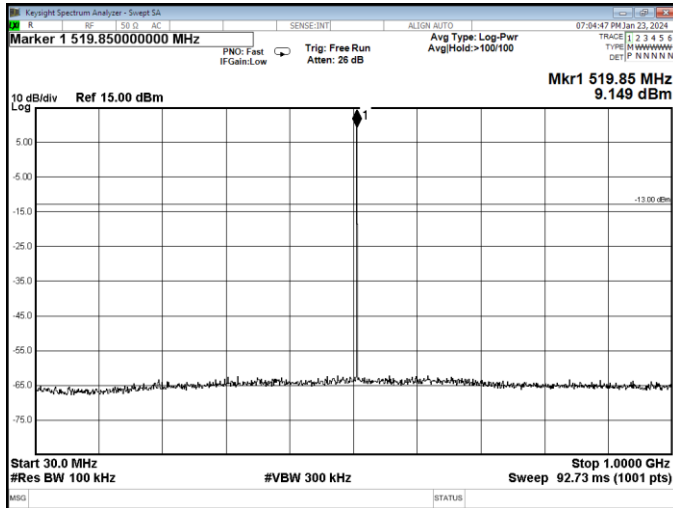

Channel 1 / 520.1 MHz

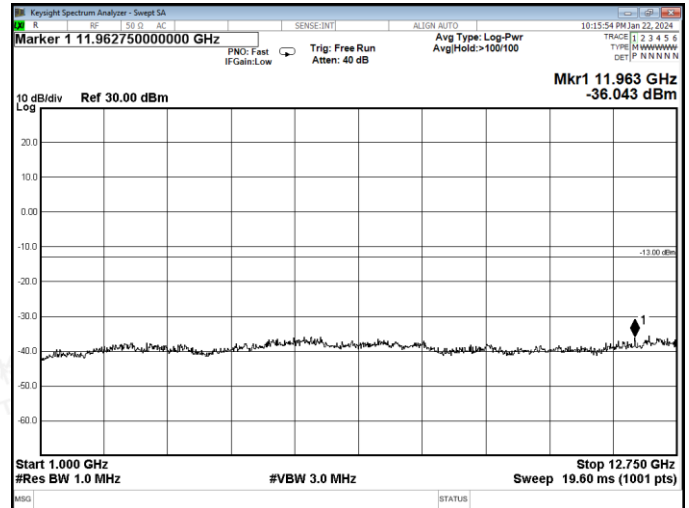

Channel 1 / 520.1 MHz

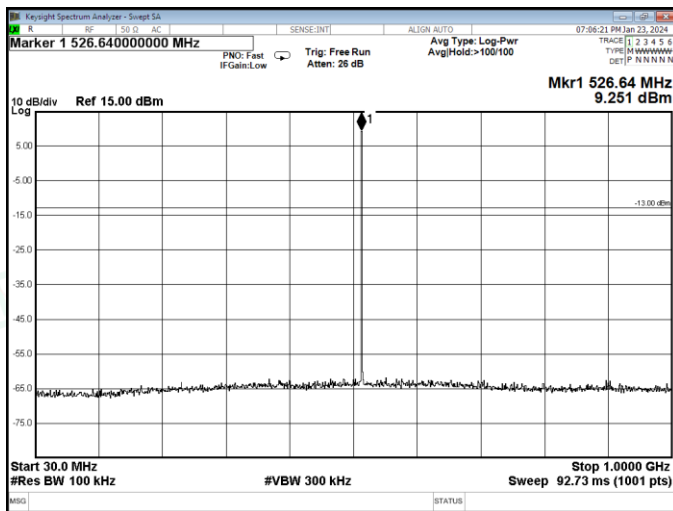

Channel 8 / 527.1 MHz

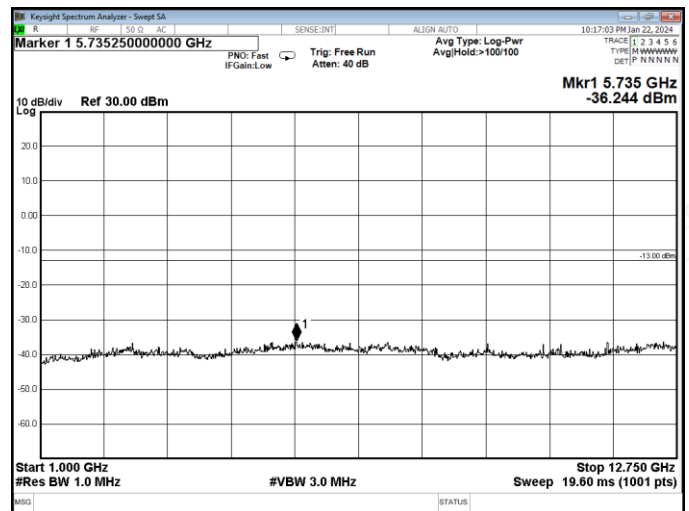

Channel 8 / 527.1 MHz

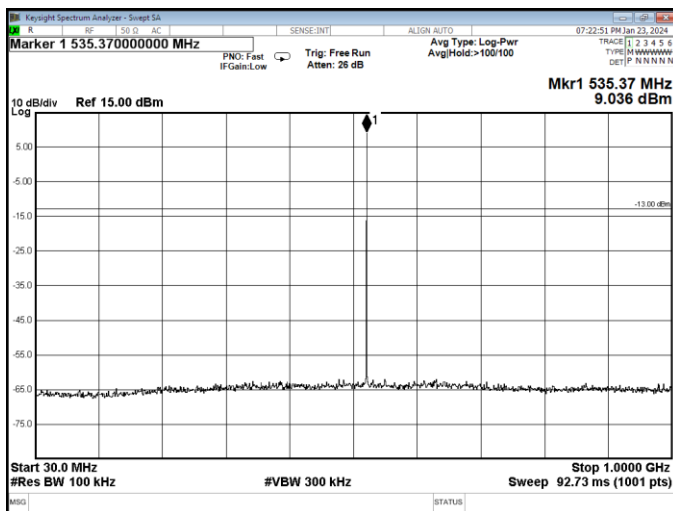

Channel 16 / 535.1 MHz

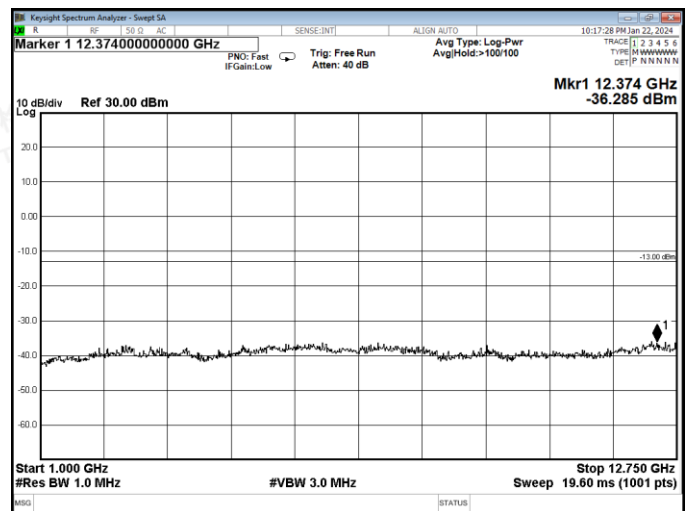

Channel 16 / 535.1 MHz



### 5.3. Transmitter unwanted emissions(radiated or conducted)

#### 5.3.1. Measurement description:

##### TEST CONFIGURATION

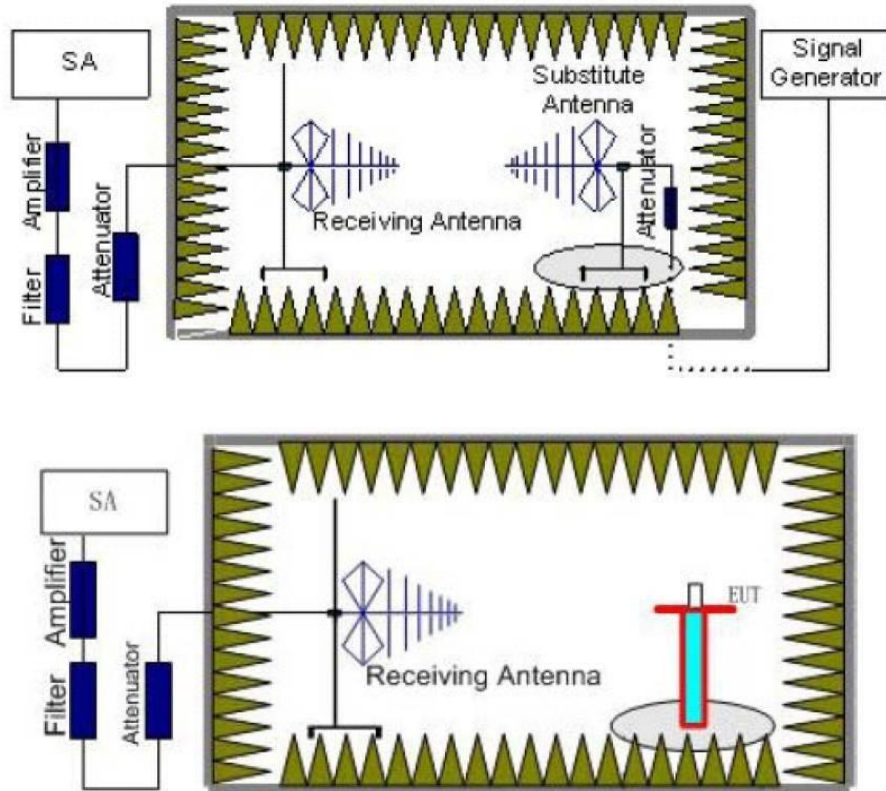

### TEST PROCEDURE

1. EUT was placed on a 1.50 meter high non-conductive stand at a 3 meter test distance from the receive antenna. A receiving antenna was placed on the antenna mast 3 meters from the EUT for emission measurements. The height of receiving antenna is 1.50 m. Detected emissions were maximized at each frequency by rotating the EUT through 360° and adjusting the receiving antenna polarization. The radiated emission measurements of all transmit frequencies in three channels (High, Middle, Low) were measured with peak detector.
2. A log-periodic antenna or double-ridged waveguide horn antenna shall be substituted in place of the EUT. The log-periodic antenna will be driven by a signal generator and the level will be adjusted till the same power value on the spectrum analyzer or receiver. The level of the spurious emissions can be calculated through the level of the signal generator, cable loss, the gain of the substitution antenna and the reading of the spectrum analyzer or receiver.
3. The EUT is then put into continuously transmitting mode at its maximum power level during the test. Set Test Receiver or Spectrum RBW=1MHz, VBW=3MHz, And the maximum value of the receiver should be recorded as ( $P_r$ ).





4. The EUT shall be replaced by a substitution antenna. In the chamber, an substitution antenna for the frequency band of interest is placed at the reference point of the chamber. An RF Signal source for the frequency band of interest is connected to the substitution antenna with a cable that has been constructed to not interfere with the radiation pattern of the antenna. A power ( $P_{Mea}$ ) is applied to the input of the substitution antenna, and adjust the level of the signal generator output until the value of the receiver reach the previously recorded ( $P_r$ ). The power of signal source ( $P_{Mea}$ ) is recorded. The test should be performed by rotating the test item and adjusting the receiving antenna polarization.
5. A amplifier should be connected to the Signal Source output port. And the cable should be connect between the Amplifier and the Substitution Antenna. The cable loss ( $P_{cl}$ ), the Substitution Antenna Gain ( $G_a$ ) and the Amplifier Gain ( $P_{Ag}$ ) should be recorded after test.  
The measurement results are obtained as described below:  
 $Power(EIRP)=P_{Mea}-P_{Ag}-P_{cl}+G_a$
6. This value is EIRP since the measurement is calibrated using an antenna of known gain (2.15 dBi) and known input power.
7. ERP can be calculated from EIRP by subtracting the gain of the dipole,  $ERP = EIRP - 2.15dBi$ .
8. In order to make sure test results more clearly, we set frequency range and sweep time for difference frequency range as follows table:

**TEST LIMITS**

FCC & IC (according to ETSI EN 300 422-1 V2.1.2 (2017-01))			
State	Max. spurious level		
	47 MHz to 74 MHz 87.5 MHz to 118 MHz 174 MHz to 230 MHz 470 MHz to 862	Other frequencies ≤ 1000 MHz	All frequencies > 1000 MHz
Operating	4.0 nW	250 nW	1.00 μW
Standby	2.0 nW	2.0 nW	20.0 nW

FCC & IC	
The mean power of emissions shall be attenuated below the mean output power of the transmitter in accordance with the following schedule:	
On any frequency removed from the operating frequency by more than 50 percent up to and including 100 percent of the authorized bandwidth: at least	25 dB
On any frequency removed from the operating frequency by more than 100 percent up to and including 250 percent of the authorized bandwidth	35 dB
On any frequency removed from the operating frequency by more than 250 percent of the authorized bandwidth: at least	$43 + 10\log_{10}$ (mean output power in watts) dB







5.3.2. Results for Radiated Emissions

Temperature	23.9°C	Humidity	52.2%
Test Engineer	Eason Zhou	Configurations	

Freq. (MHz)	Level (dBuV)	Over Limit (dB)	Over Limit (dBuV)	Remark
-	-	-	-	See Note

Channel 1 / 520.1MHz

Horizontal

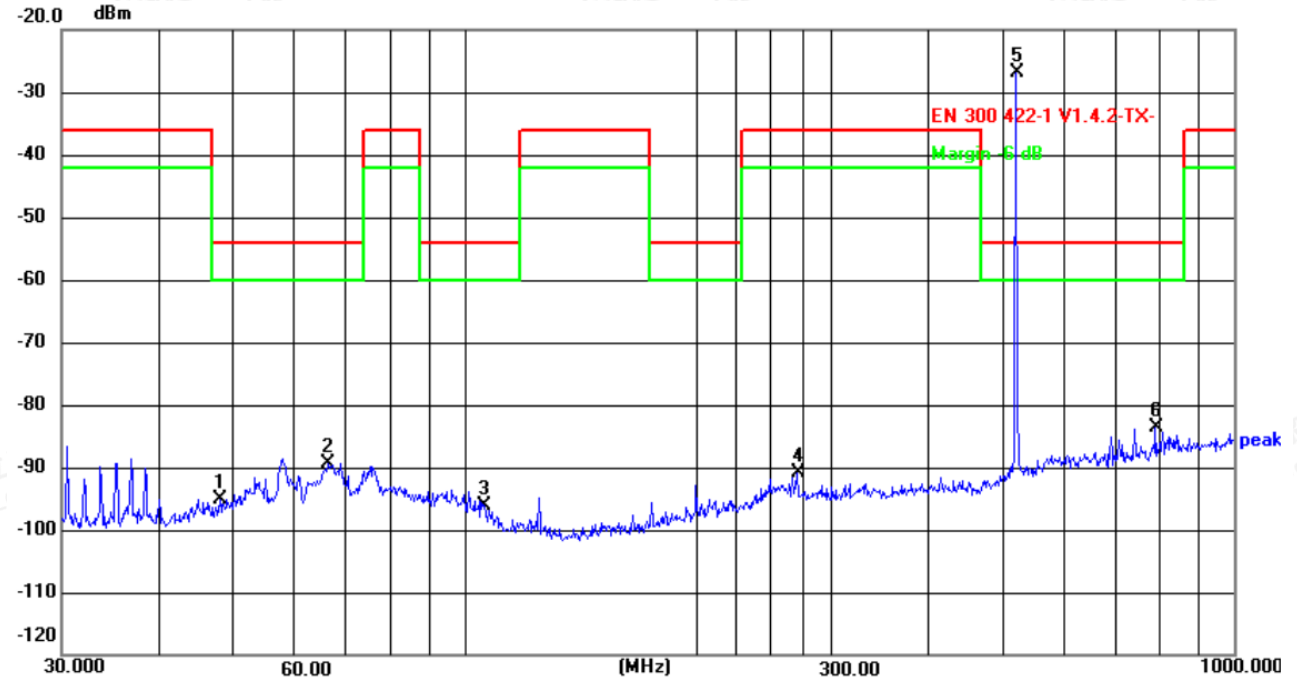

No.	Frequency (MHz)	Reading (dBm)	Factor (dB)	Level (dBm)	Limit (dBm)	Margin (dB)	Detector
1	48.1625	-78.05	-16.98	-95.03	-54.00	-41.03	peak
2	66.4989	-70.00	-19.25	-89.25	-54.00	-35.25	peak
3	106.3850	-77.31	-18.74	-96.05	-54.00	-42.05	peak
4	270.3748	-75.47	-15.42	-90.89	-36.00	-54.89	peak
5	520.8882	-14.17	-12.80	-26.97	-54.00	27.03	peak
6	790.6187	-73.58	-10.03	-83.61	-54.00	-29.61	peak





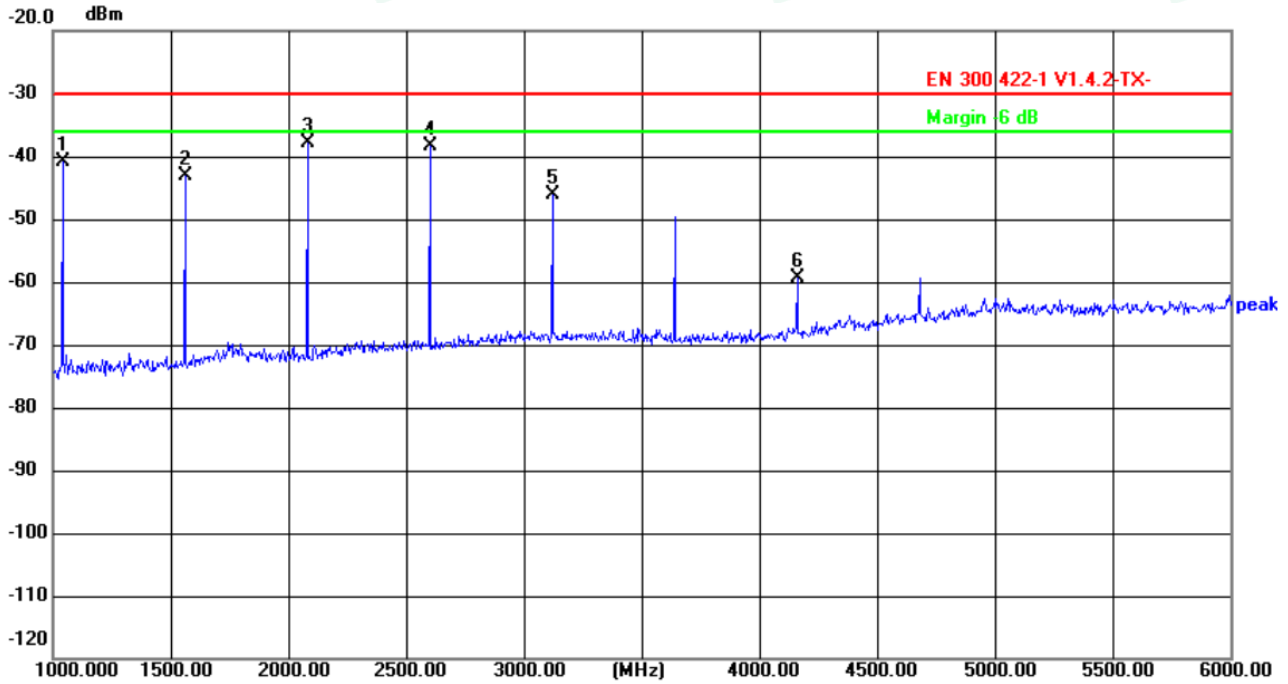

No.	Frequency (MHz)	Reading (dBm)	Factor (dB)	Level (dBm)	Limit (dBm)	Margin (dB)	Detector
1	1040.000	-25.36	-15.41	-40.77	-30.00	-10.77	peak
2	1560.000	-28.28	-14.74	-43.02	-30.00	-13.02	peak
3	2080.000	-24.97	-12.82	-37.79	-30.00	-7.79	peak
4	2600.000	-27.43	-10.99	-38.42	-30.00	-8.42	peak
5	3120.000	-36.48	-9.56	-46.04	-30.00	-16.04	peak
6	4160.000	-51.36	-7.91	-59.27	-30.00	-29.27	peak





Channel 1 / 520.1MHz

Vertical

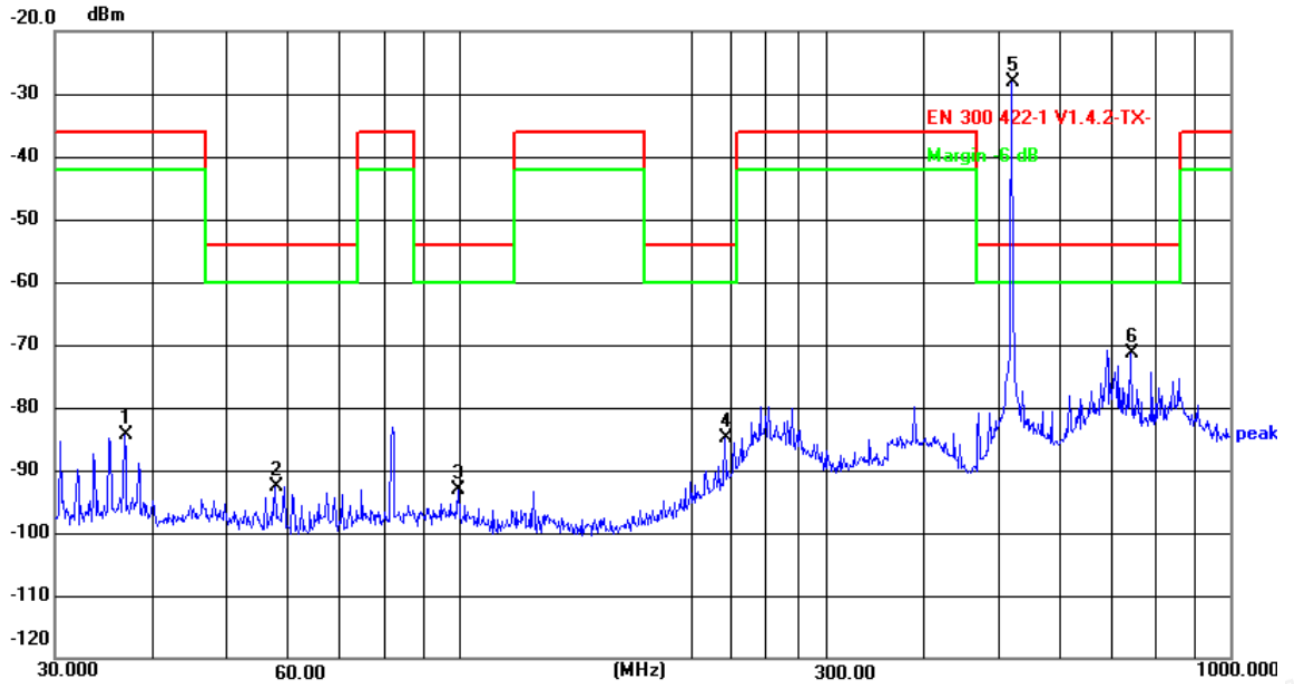

No.	Frequency (MHz)	Reading (dBm)	Factor (dB)	Level (dBm)	Limit (dBm)	Margin (dB)	Detector
1	36.8953	-66.67	-17.69	-84.36	-36.00	-48.36	peak
2	57.7962	-74.12	-18.45	-92.57	-54.00	-38.57	peak
3	99.8777	-74.98	-18.19	-93.17	-54.00	-39.17	peak
4	221.3921	-67.93	-16.84	-84.77	-54.00	-30.77	peak
5	520.8882	-15.26	-12.80	-28.06	-54.00	25.94	peak
6	742.2587	-61.14	-10.26	-71.40	-54.00	-17.40	peak



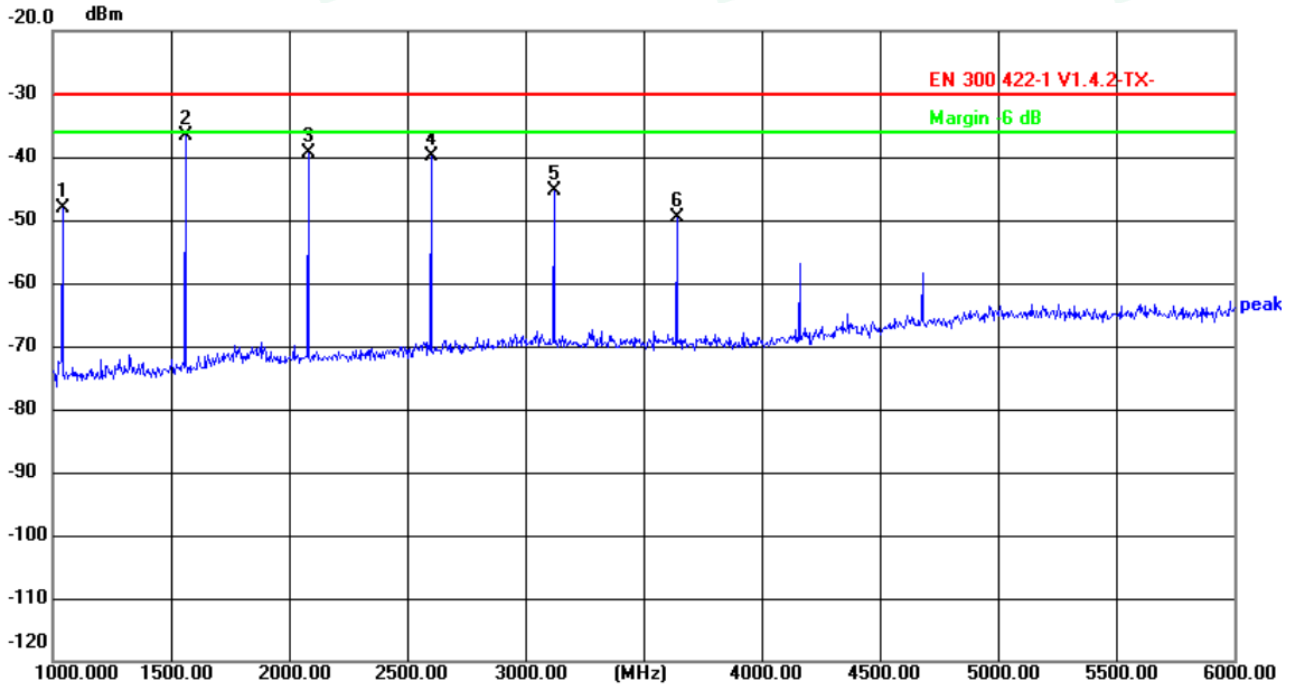

No.	Frequency (MHz)	Reading (dBm)	Factor (dB)	Level (dBm)	Limit (dBm)	Margin (dB)	Detector
1	1040.000	-32.72	-15.41	-48.13	-30.00	-18.13	peak
2	1560.000	-21.83	-14.74	-36.57	-30.00	-6.57	peak
3	2080.000	-26.60	-12.82	-39.42	-30.00	-9.42	peak
4	2600.000	-28.83	-10.99	-39.82	-30.00	-9.82	peak
5	3120.000	-35.82	-9.56	-45.38	-30.00	-15.38	peak
6	3640.000	-40.42	-9.17	-49.59	-30.00	-19.59	peak





Channel 8 / 527.1MHz

Horizontal

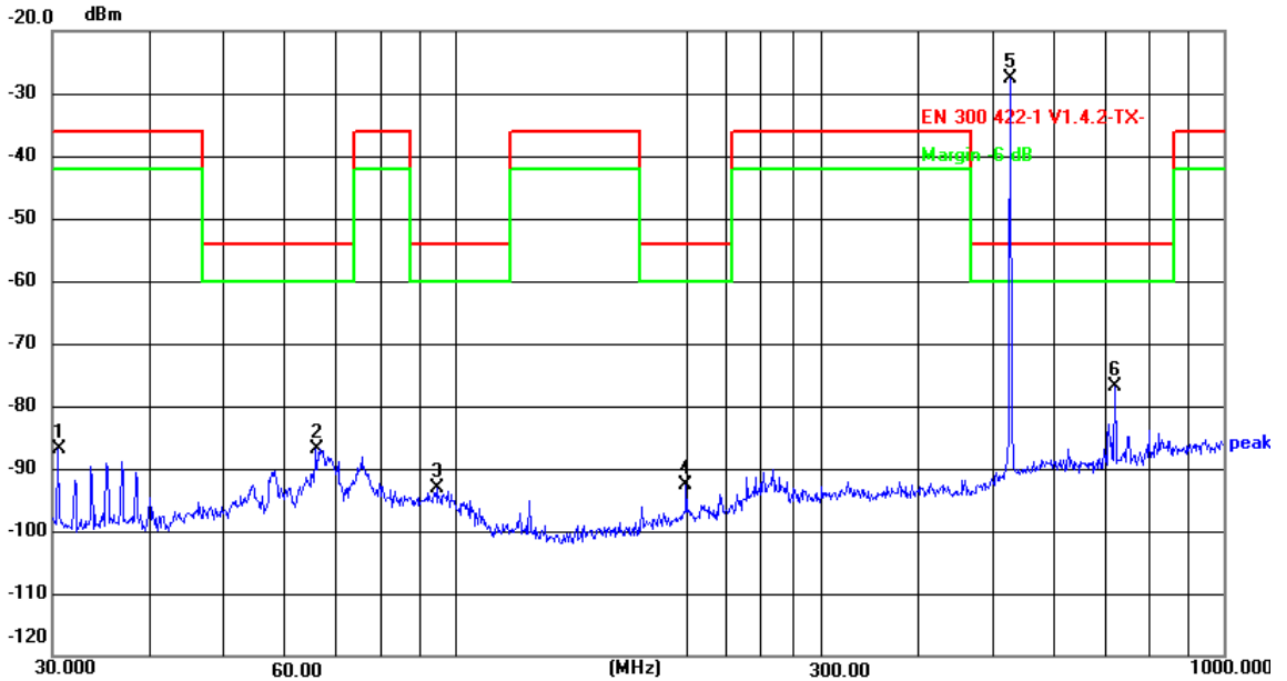

No.	Frequency (MHz)	Reading (dBm)	Factor (dB)	Level (dBm)	Limit (dBm)	Margin (dB)	Detector
1	30.5306	-68.51	-18.39	-86.90	-36.00	-50.90	peak
2	66.0342	-67.65	-19.22	-86.87	-54.00	-32.87	peak
3	94.7600	-74.63	-18.55	-93.18	-54.00	-39.18	peak
4	199.9855	-75.17	-17.39	-92.56	-54.00	-38.56	peak
5	528.2458	-14.93	-12.61	-27.54	-54.00	26.46	peak
6	721.7258	-66.35	-10.58	-76.93	-54.00	-22.93	peak



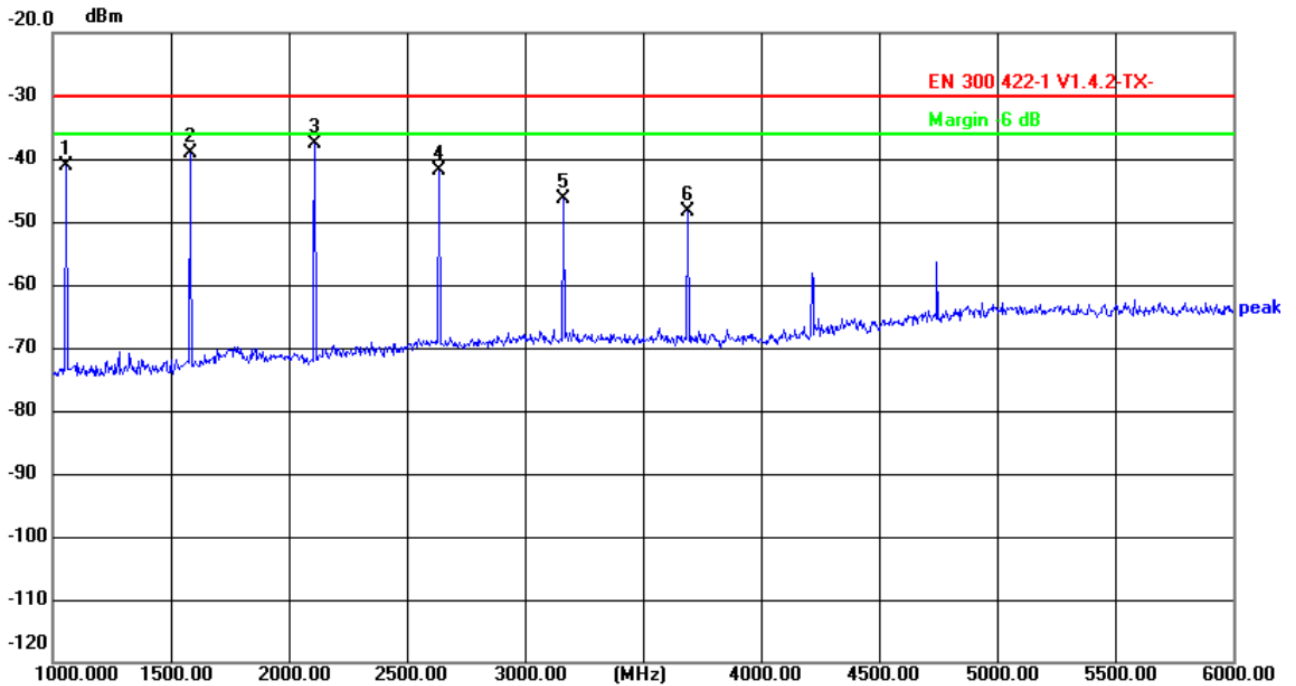

No.	Frequency (MHz)	Reading (dBm)	Factor (dB)	Level (dBm)	Limit (dBm)	Margin (dB)	Detector
1	1055.000	-25.79	-15.38	-41.17	-30.00	-11.17	peak
2	1580.000	-24.35	-14.67	-39.02	-30.00	-9.02	peak
3	2110.000	-24.86	-12.72	-37.58	-30.00	-7.58	peak
4	2635.000	-31.09	-10.88	-41.97	-30.00	-11.97	peak
5	3165.000	-36.78	-9.53	-46.31	-30.00	-16.31	peak
6	3690.000	-39.34	-9.09	-48.43	-30.00	-18.43	peak





Channel 8 / 527.1MHz

Vertical

-20.0 dBm

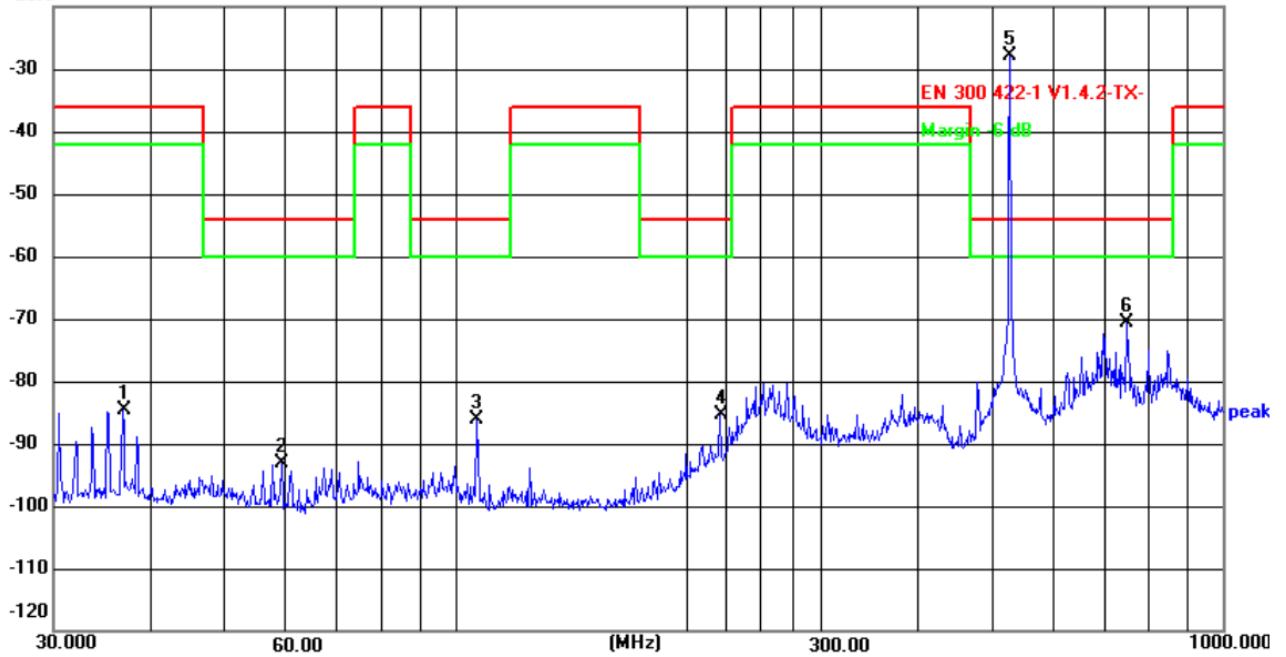

No.	Frequency (MHz)	Reading (dBm)	Factor (dB)	Level (dBm)	Limit (dBm)	Margin (dB)	Detector
1	36.8953	-66.87	-17.69	-84.56	-36.00	-48.56	peak
2	59.4405	-74.33	-18.75	-93.08	-54.00	-39.08	peak
3	106.7587	-67.44	-18.78	-86.22	-54.00	-32.22	peak
4	221.3921	-68.44	-16.84	-85.28	-54.00	-31.28	peak
5	528.2458	-15.36	-12.61	-27.97	-54.00	26.03	peak
6	750.1082	-60.49	-10.13	-70.62	-54.00	-16.62	peak



Shenzhen LCS Compliance Testing Laboratory Ltd.

Add: 101, 201 Bldg A & 301 Bldg C, Juji Industrial Park Yabianxueziwei, Shajing Street, Baoan District, Shenzhen, 518000, China

Tel: +(86) 0755-82591330 | E-mail: webmaster@lcs-cert.com | Web: www.lcs-cert.com

Scan code to check authenticity



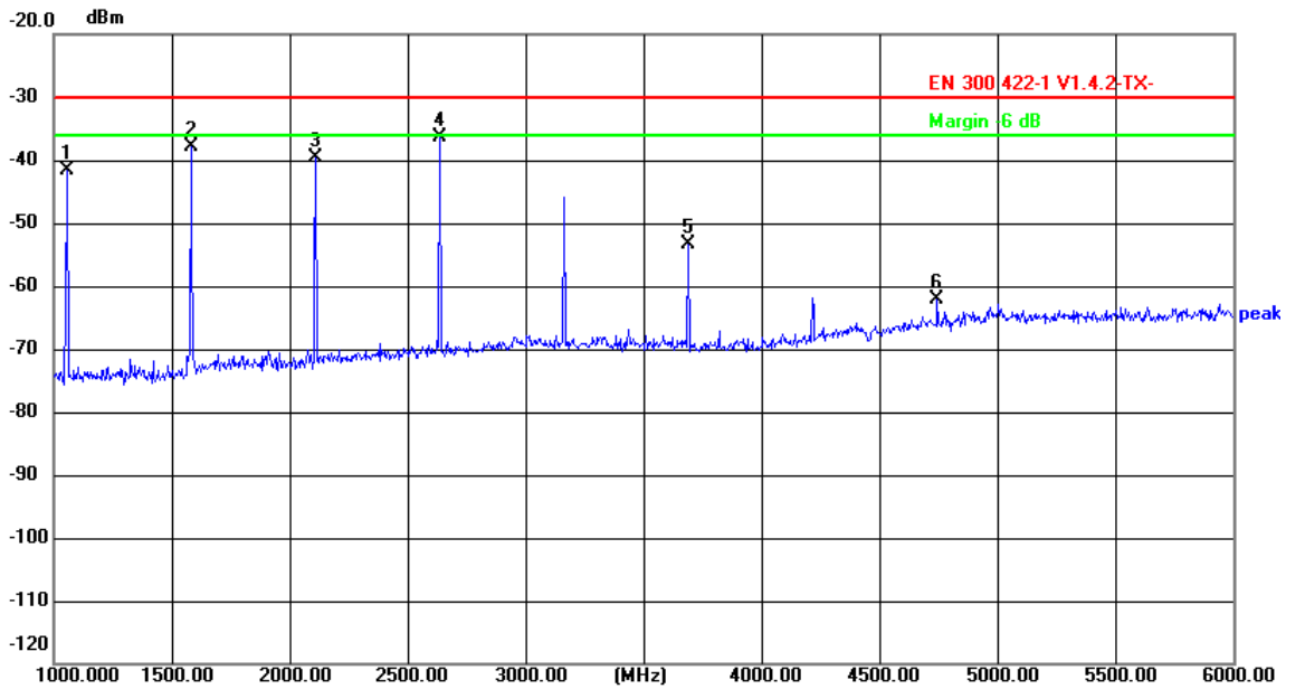

No.	Frequency (MHz)	Reading (dBm)	Factor (dB)	Level (dBm)	Limit (dBm)	Margin (dB)	Detector
1	1055.000	-26.34	-15.38	-41.72	-30.00	-11.72	peak
2	1580.000	-23.18	-14.67	-37.85	-30.00	-7.85	peak
3	2110.000	-26.91	-12.72	-39.63	-30.00	-9.63	peak
4	2635.000	-25.57	-10.88	-36.45	-30.00	-6.45	peak
5	3690.000	-44.35	-9.09	-53.44	-30.00	-23.44	peak
6	4745.000	-56.71	-5.38	-62.09	-30.00	-32.09	peak





Channel 16 / 535.1MHz

Horizontal

-20.0 dBm

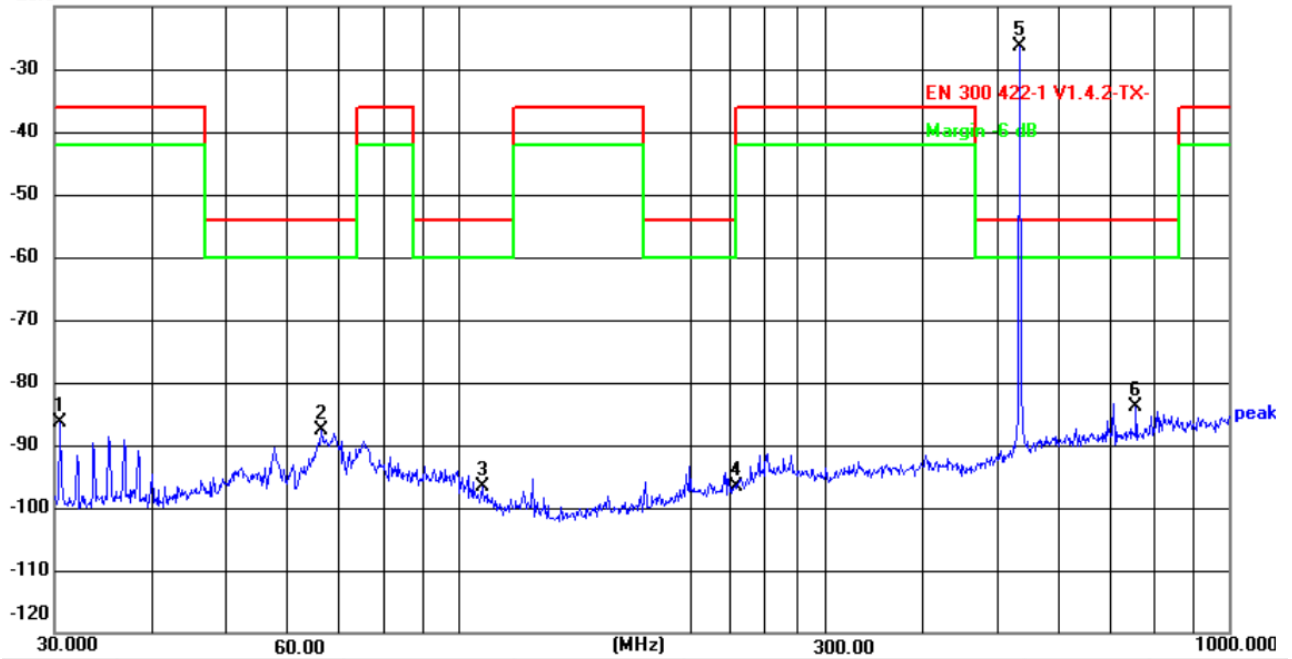

No.	Frequency (MHz)	Reading (dBm)	Factor (dB)	Level (dBm)	Limit (dBm)	Margin (dB)	Detector
1	30.5304	-68.04	-18.39	-86.43	-36.00	-50.43	peak
2	66.4989	-68.44	-19.25	-87.69	-54.00	-33.69	peak
3	107.5100	-77.83	-18.84	-96.67	-54.00	-42.67	peak
4	228.4902	-80.01	-16.59	-96.60	-54.00	-42.60	peak
5	535.7073	-14.01	-12.32	-26.33	-54.00	27.67	peak
6	758.0407	-73.73	-10.13	-83.86	-54.00	-29.86	peak



Shenzhen LCS Compliance Testing Laboratory Ltd.

Add: 101, 201 Bldg A & 301 Bldg C, Juji Industrial Park Yabianxueziwei, Shajing Street, Baoan District, Shenzhen, 518000, China

Tel: +(86) 0755-82591330 | E-mail: webmaster@lcs-cert.com | Web: www.lcs-cert.com

Scan code to check authenticity

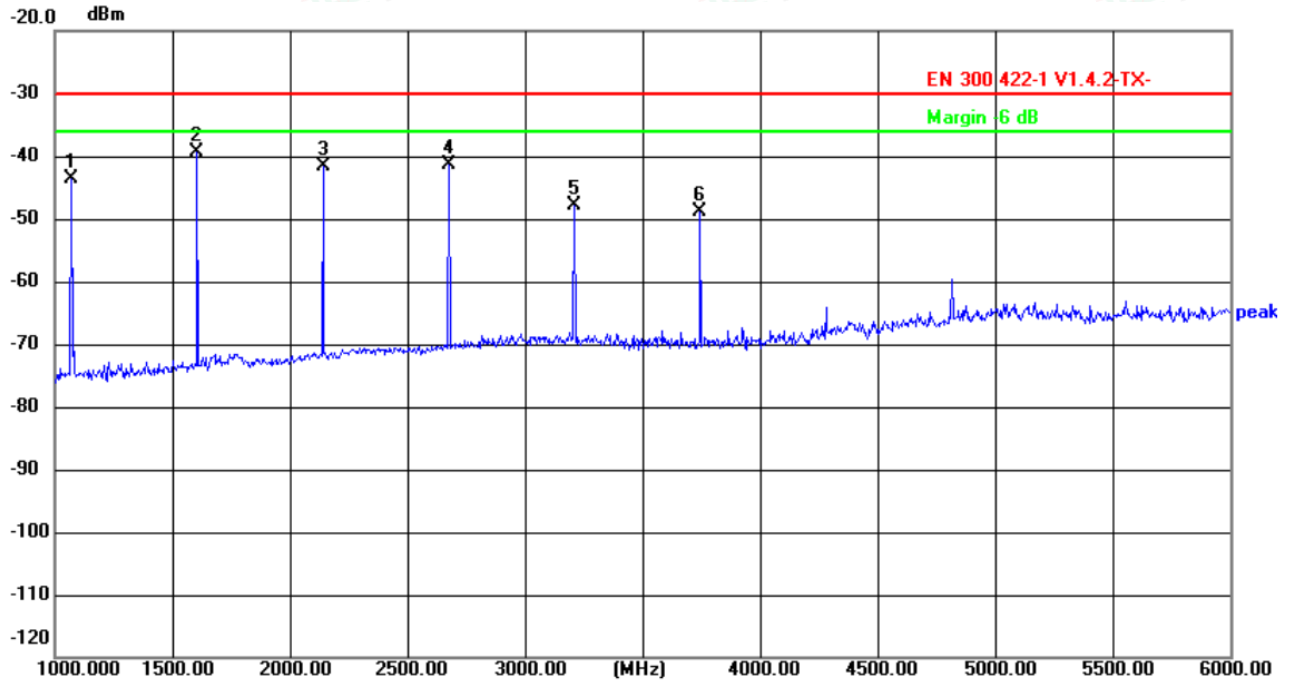

No.	Frequency (MHz)	Reading (dBm)	Factor (dB)	Level (dBm)	Limit (dBm)	Margin (dB)	Detector
1	1070.000	-28.19	-15.37	-43.56	-30.00	-13.56	peak
2	1605.000	-24.82	-14.60	-39.42	-30.00	-9.42	peak
3	2140.000	-29.13	-12.60	-41.73	-30.00	-11.73	peak
4	2675.000	-30.65	-10.73	-41.38	-30.00	-11.38	peak
5	3210.000	-38.27	-9.52	-47.79	-30.00	-17.79	peak
6	3745.000	-39.80	-8.99	-48.79	-30.00	-18.79	peak





Channel 16 / 535.1MHz

Vertical

-20.0 dBm

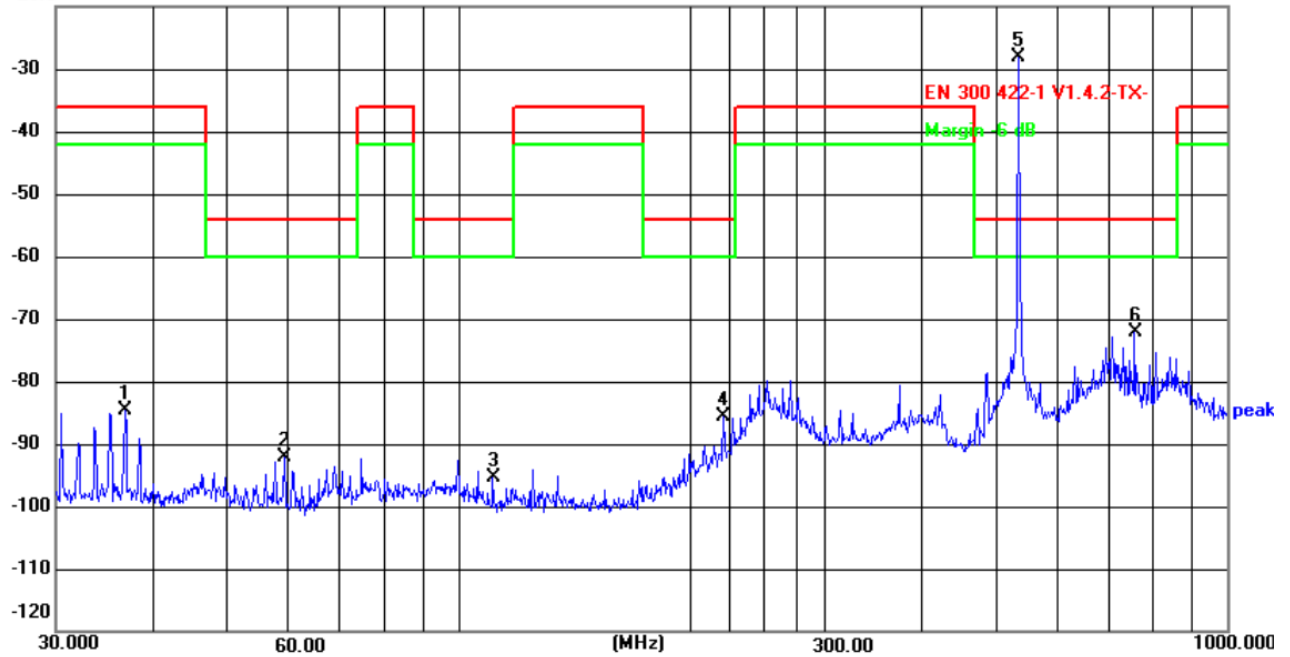

No.	Frequency (MHz)	Reading (dBm)	Factor (dB)	Level (dBm)	Limit (dBm)	Margin (dB)	Detector
1	36.8953	-66.92	-17.69	-84.61	-36.00	-48.61	peak
2	59.4405	-73.40	-18.75	-92.15	-54.00	-38.15	peak
3	110.9571	-76.14	-19.15	-95.29	-54.00	-41.29	peak
4	221.3921	-68.71	-16.84	-85.55	-54.00	-31.55	peak
5	535.7073	-15.71	-12.32	-28.03	-54.00	25.97	peak
6	758.0408	-62.08	-10.13	-72.21	-54.00	-18.21	peak



Shenzhen LCS Compliance Testing Laboratory Ltd.

Add: 101, 201 Bldg A & 301 Bldg C, Juji Industrial Park Yabianxueziwei, Shajing Street, Baoan District, Shenzhen, 518000, China

Tel: +(86) 0755-82591330 | E-mail: webmaster@lcs-cert.com | Web: www.lcs-cert.com

Scan code to check authenticity

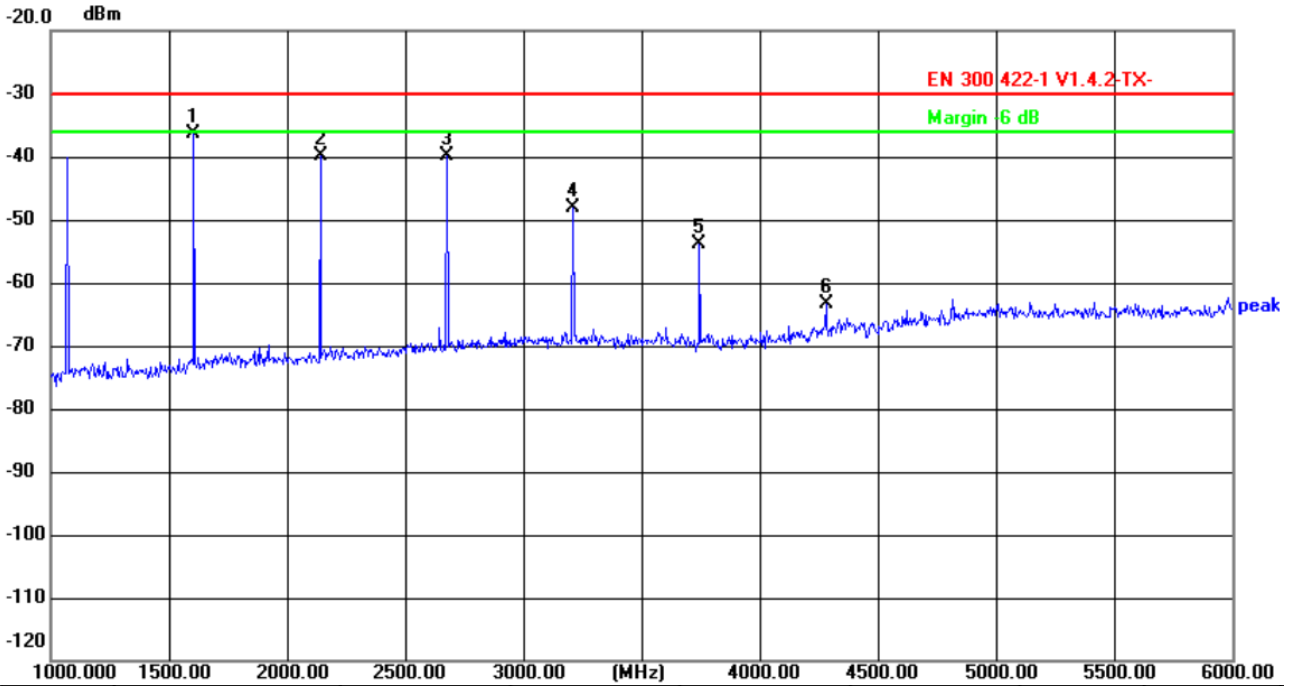

No.	Frequency (MHz)	Reading (dBm)	Factor (dB)	Level (dBm)	Limit (dBm)	Margin (dB)	Detector
1	1605.000	-21.77	-14.60	-36.37	-30.00	-6.37	peak
2	2140.000	-27.39	-12.60	-39.99	-30.00	-9.99	peak
3	2675.000	-29.19	-10.73	-39.92	-30.00	-9.92	peak
4	3210.000	-38.72	-9.52	-48.24	-30.00	-18.24	peak
5	3745.000	-44.87	-8.99	-53.86	-30.00	-23.86	peak
6	4280.000	-55.95	-7.44	-63.39	-30.00	-33.39	peak

Note: 1, All detected emissions are more than 20 dB below the limit, In addition to main frequency.  
 2. Corrected Reading: Antenna Factor + Cable Loss + Read Level - Preamp Factor = Level.





## 5.4. Conducted spurious emission

### 5.4.1. Description:

Measurement of the conducted spurious emissions in transmit mode below 30 MHz. The EUT is set to channel 6. This measurement is repeated for DSSS and OFDM modulation. If peaks are found channel 1 and channel 11 will be measured too. The measurement is performed with the data rate producing the highest output power. Both power lines, phase and neutral line, are measured. Found peaks are re-measured with average and quasi peak detection to show compliance to the limits.

### 5.4.2. Measurement:

Measurement parameter	
Detector:	Peak - Quasi Peak / Average
Sweep time:	Auto
Resolution bandwidth:	F < 150 kHz: 200 Hz F > 150 kHz: 9 kHz
Video bandwidth:	F < 150 kHz: 1 kHz F > 150 kHz: 100 kHz
Span:	9 kHz to 30 MHz
Trace mode:	Max Hold

### 5.4.3. Limits:

FCC		
Frequency (MHz)	Quasi-Peak (dB $\mu$ V/m)	Average (dB $\mu$ V/m)
0.15 – 0.5	66 to 56*	56 to 46*
0.5 – 5	56	46
5 – 30.0	60	50

### 5.4.4. Results:

Not Applicable.







### 5.5. Frequency Stability

Test Requirement: FCC CFR 47 Part 74.e) 4)

Test Method: FCC CFR 47 Part 2.1055

Requirements: +/-50 ppm

(e) For low power auxiliary stations operating in the bands allocated for TV broadcasting, the following technical requirements apply:

(4) The frequency tolerance of the transmitter shall be 0.005 percent.

Test Procedure:

Frequency stability versus Environmental Temperature

The equipment under test was connected to an external DC power supply and the RF output was connected to a frequency counter via feed through attenuators.

The EUT was placed inside the temperature chamber. After the temperature stabilized for approximately 20 minutes, the frequency of the output signal was recorded from the counter.

Frequency Stability versus Input Voltage

At room temperature ( $25 \pm 5^\circ\text{C}$ ), an external variable DC power supply was connected to the EUT. The frequency of the transmitter was measured for 115%, 100% and 85% of the nominal operating input voltage. For hand carried, battery powered equipment, reduce primary supply voltage to the battery operating end point which shall be specified by the manufacturer.

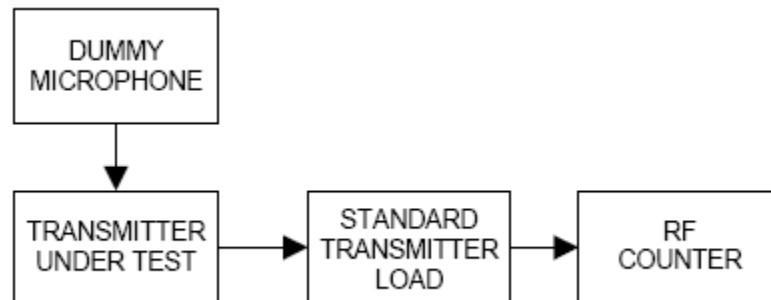

Shenzhen LCS Compliance Testing Laboratory Ltd.

Add: 101, 201 Bldg A & 301 Bldg C, Juji Industrial Park Yabianxueziwei, Shajing Street, Baoan District, Shenzhen, 518000, China

Tel: +(86) 0755-82591330 | E-mail: webmaster@lcs-cert.com | Web: www.lcs-cert.com

Scan code to check authenticity



Test Result:

Channel

Assigned Frequency: 520.1 MHz		
Environment Temperature (°C)	Power Supplied (Vdc)	Frequency Measure with Time Elapsed Total emission within +/- 26.005 kHz
50	3.0	+2.81
40	3.0	+2.31
30	3.0	+2.08
20	3.0	+1.74
10	3.0	-0.93
0	3.0	-1.46
-10	3.0	-1.89
-20	3.0	-2.20
-30	3.0	-2.32
Environment Temperature (°C)	Power Supplied (Vdc)	Frequency Measure with Time Elapsed Total emission within Max +/- 26.005 kHz
25	3.3	+2.03
25	3.0	-1.80
25	2.7	-2.13

Assigned Frequency: 527.1 MHz		
Environment Temperature (°C)	Power Supplied (Vdc)	Frequency Measure with Time Elapsed Total emission within +/- 26.355 kHz
50	3.0	+2.70
40	3.0	+2.35
30	3.0	+2.10
20	3.0	+1.77
10	3.0	-0.92
0	3.0	-1.47
-10	3.0	-1.73
-20	3.0	-2.12
-30	3.0	-2.39
Environment Temperature (°C)	Power Supplied (Vdc)	Frequency Measure with Time Elapsed Total emission within Max +/- 26.355 kHz
25	3.3	+2.18
25	3.0	-1.76
25	2.7	-2.06





Assigned Frequency: 535.1 MHz		
Environment Temperature (°C)	Power Supplied (Vdc)	Frequency Measure with Time Elapsed Total emission within +/- 26.755 kHz
50	3.0	+2.52
40	3.0	+2.32
30	3.0	+2.07
20	3.0	+1.64
10	3.0	-0.96
0	3.0	-1.50
-10	3.0	-1.74
-20	3.0	-2.17
-30	3.0	-2.32
Environment Temperature (°C)	Power Supplied (Vdc)	Frequency Measure with Time Elapsed Total emission within Max +/- 26.755 kHz
25	3.3	+2.03
25	3.0	-1.62
25	2.7	-2.07

Battery end point: 3.0Vdc

The results: The unit does meet the FCC requirements.





### 5.6.Modulation Characteristics

Test Requirement:FCC CFR 47 Part 74.e) 3)

Test Method:FCC CFR 47 Part 2.1047 & TIA/EIA 603 E 2016:Land Mobile FM or PM Communications Equipment Measurement and Performance Standards

Requirements:

(e) For low power auxiliary stations operating in the bands allocated for TV broadcasting, the following technical requirements apply:

(3) Any form of modulation may be used. A maximum deviation of  $\pm 75$  kHz is permitted when frequency modulation is employed.

Test Procedure:

#### Audio Frequency Response

The RF output of the transceiver was connected to the input of FSP 30 with FM deviation module through sufficient attenuation so as not to overload the meter or distort the reading. An audio signal generator was connected to the audio input of microphone.

The audio signal input level was adjusted to obtain 20% of the maximum rated system deviation at 1 kHz, and recorded as DEV REF . With the audio signal generator level unchanged, set the generator frequency between 100 to 5000 Hz. The transmitter deviations (DEV FREQ ) were measured and the audio frequency response was calculated as  $20\log_{10} [DEV FREQ / DEV REF ]$

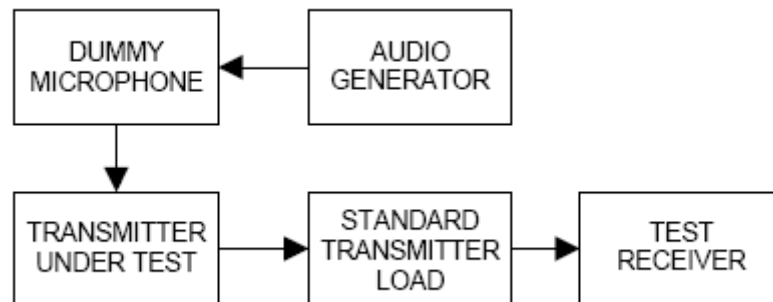

The plot(s) of Audio Frequency Response is presented hereinafter as reference.

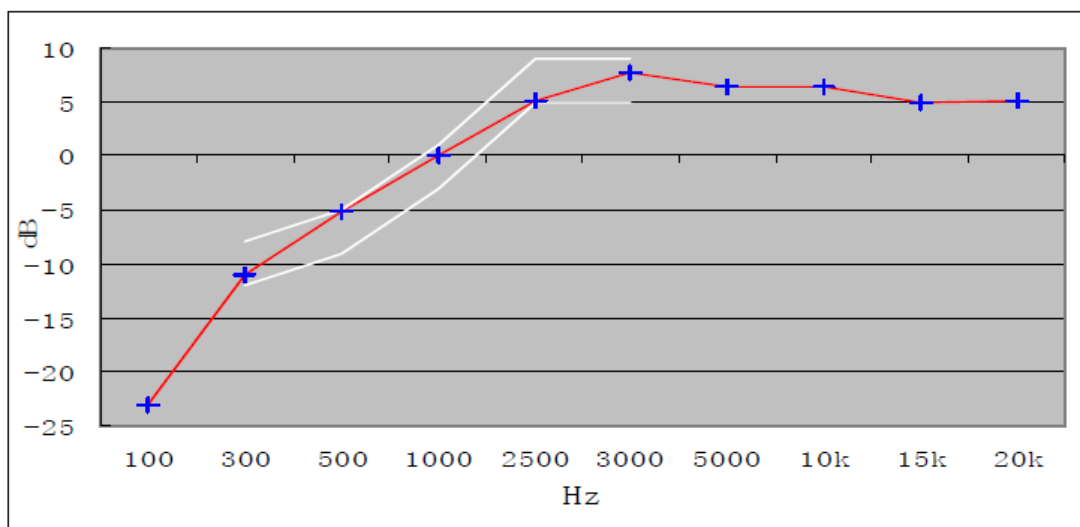

0dB=10mV at 1kHz (20% of the maximum rated system deviation).





### Modulation Limiting

- a) Adjust the transmitter per the manufacturer's procedure for full rated system deviation.
- b) Set the test receiver to measure peak positive deviation. Set the audio bandwidth for  $\leq 0.25$  Hz to  $\geq 15,000$  Hz. Turn the de-emphasis function off.
- c) Apply a **1000 Hz** modulating signal to the transmitter from the audio frequency generator, and adjust the level to obtain **60% of full rated system deviation**.
- d) Increase the level from the audio frequency generator by 20 dB in one step (rise time between the 10% and 90% points shall be 0.1 second maximum).
- e) Measure both the instantaneous and steady-state deviation at and after the time of increasing the audio input level.

With the level from the audio frequency generator held constant at the level obtained in step e), slowly vary the audio frequency from 100 to 15k Hz and observe the steady-state deviation. Record the maximum deviation.

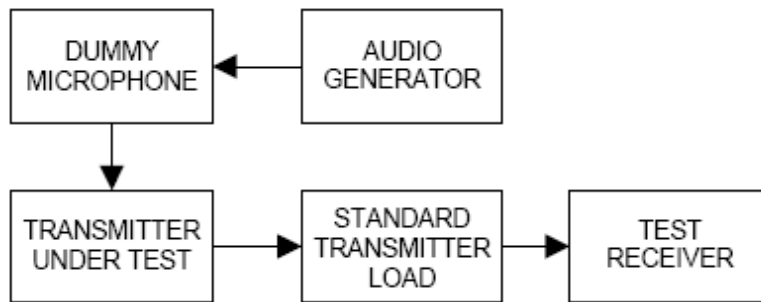

Test at five different modulating frequencies (100Hz ,300Hz, 500Hz, 1KHz, 2.5kHz, 5kHz, 10kHz, 15kHz), the output level of the audio generator was varied up to 1V and the FM deviation level was recorded.

Positive peak deviation

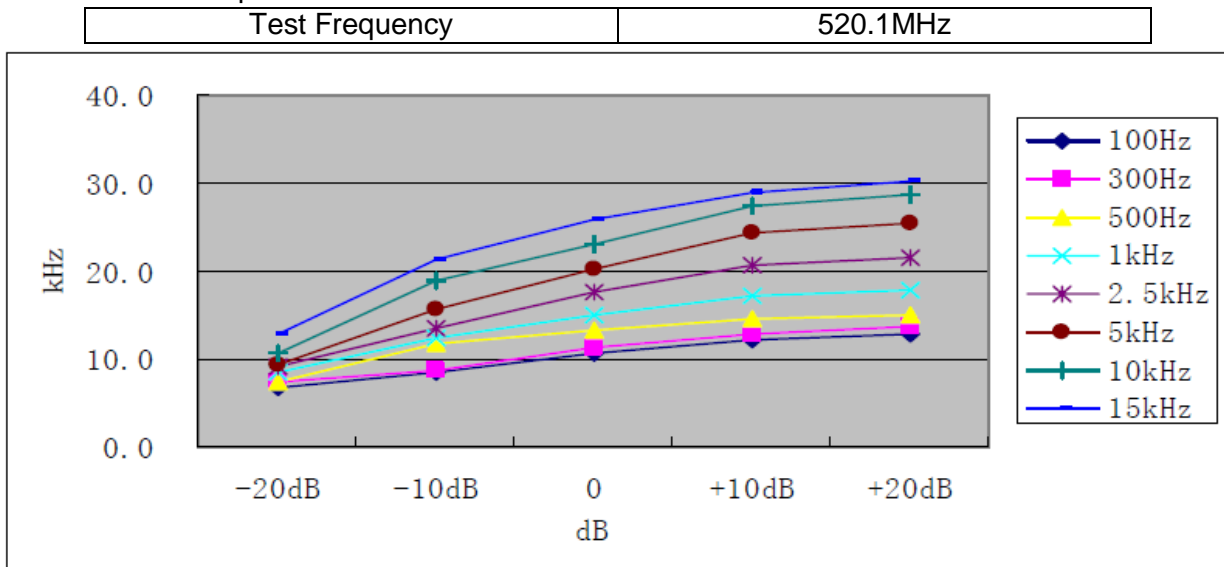



### 5.7.Necessary bandwidth (BN) for analogue systems

#### 5.7.1.Measurement:

Measurement parameter	
Detector:	Peak - Quasi Peak / Average
Sweep time:	Auto
Resolution bandwidth:	1 kHz
Video bandwidth:	1 kHz
Span:	Fc-1MHz to fc+1MHz(2MHz)
Trace mode:	Max Hold

#### 5.7.2.Limits:

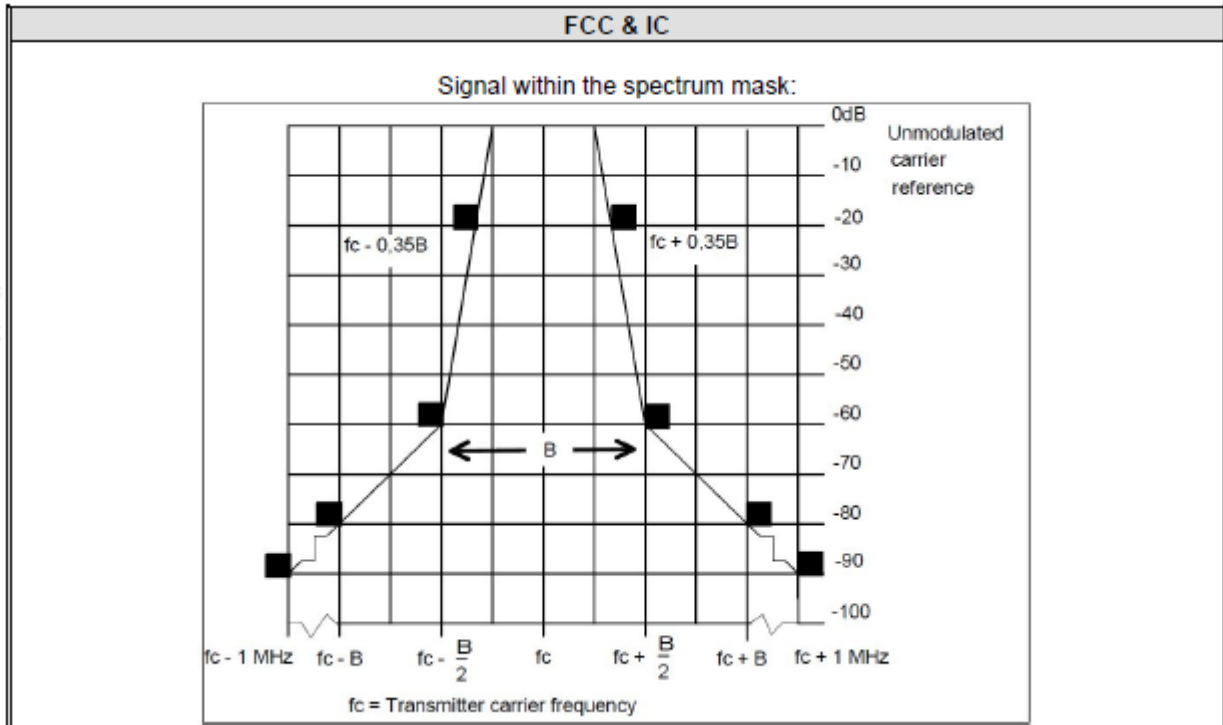



5.7.3. Results:

Channel

Necessary bandwidth

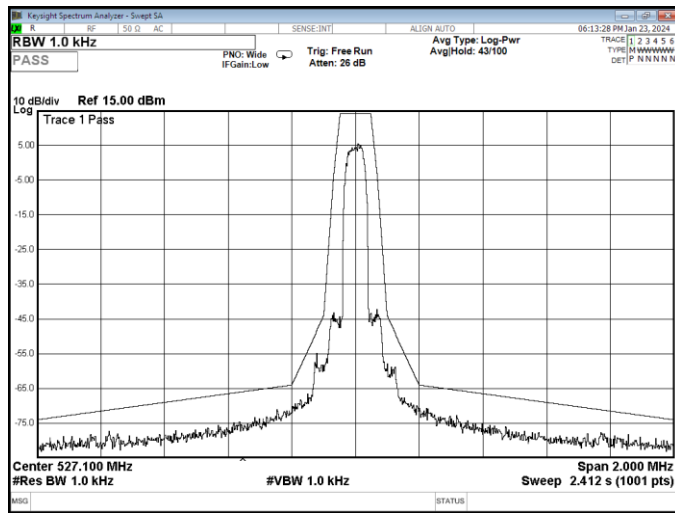

Channel 1 / 520.1 MHz

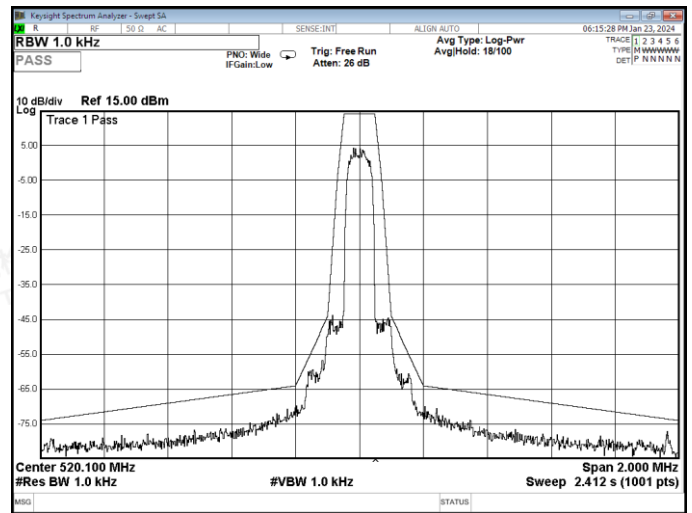

Channel 8 / 527.1 MHz

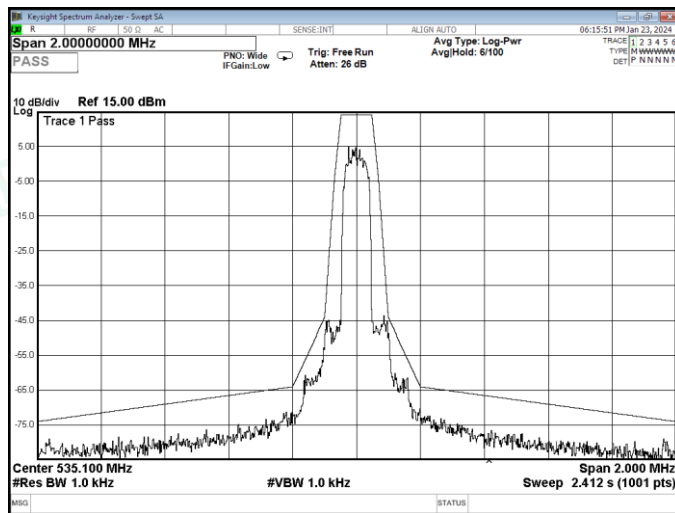

Channel 16 / 535.1 MHz







## 6. LIST OF MEASURING EQUIPMENTS

Item	Equipment	Manufacturer	Model No.	Serial No.	Cal Date	Due Date
1	MXA Signal Analyzer	Agilent	N9020A	MY49100060	2023-10-18	2024-10-17
2	DC Power Supply	Agilent	E3642A	N/A	2023-10-18	2024-10-17
3	Temperature & Humidity Chamber	GUANGZHOU GOGNWEN	GDS-100	70932	2023-10-05	2024-10-04
4	EMI Test Software	AUDIX	E3	/	N/A	N/A
5	3m Semi Anechoic Chamber	SIDT FRANKONIA	SAC-3M	03CH03-HY	2023-06-09	2024-06-08
6	Positioning Controller	Max-Full	MF7802BS	MF780208586	N/A	N/A
7	Active Loop Antenna	SCHWARZBECK	FMZB 1519B	00005	2021-08-29	2024-08-28
8	By-log Antenna	SCHWARZBECK	VULB9163	9163-470	2021-09-12	2024-09-11
9	Horn Antenna	SCHWARZBECK	BBHA 9120D	9120D-1925	2021-09-05	2024-09-04
10	EMI Test Receiver	R&S	ESR 7	101181	2023-08-15	2024-08-14
11	RS SPECTRUM ANALYZER	R&S	FSP40	100503	2023-07-17	2024-07-16
12	Low-frequency amplifier	SchwarzZBECK	BBV9745	00253	2023-10-18	2024-10-17
13	High-frequency amplifier	JS Denki Pte	PA0118-43	JSPA21009	2023-10-18	2024-10-17
14	EMI Test Receiver	R&S	ESPI	101940	2023-08-15	2024-08-14
15	Artificial Mains	R&S	ENV216	101288	2023-06-09	2024-06-08
16	10dB Attenuator	SCHWARZBECK	MTS-IMP-136	261115-001-0032	2023-06-09	2024-06-08
17	EMI Test Software	Farad	EZ	/	N/A	N/A
18	Broadband Horn Antenna	SCHWARZBECK	BBHA 9170	791	2021-08-29	2024-08-28
19	Broadband Preampifier	SCHWARZBECK	BBV9719	9719-025	2023-06-16	2024-06-15



Shenzhen LCS Compliance Testing Laboratory Ltd.

Add: 101, 201 Bldg A & 301 Bldg C, Juji Industrial Park Yabianxueziwei, Shajing Street, Baoan District, Shenzhen, 518000, China

Tel: +(86) 0755-82591330 | E-mail: webmaster@lcs-cert.com | Web: www.lcs-cert.com

Scan code to check authenticity



## 7. TEST SETUP PHOTOGRAPHS OF EUT

Please refer to separated files for Test Setup Photos of the EUT.

## 8. EXTERIOR PHOTOGRAPHS OF THE EUT

Please refer to separated files for External Photos of the EUT.

## 9. INTERIOR PHOTOGRAPHS OF THE EUT

Please refer to separated files for Internal Photos of the EUT.

-----THE END OF REPORT-----

