

日期 Date	修改内容 Description	发行版本 Revision	变更编号 ECN NO.
Dec.28,2023	First release	A / 0	---

Frequency (MHz)	Gain (dBi)
13.56	0

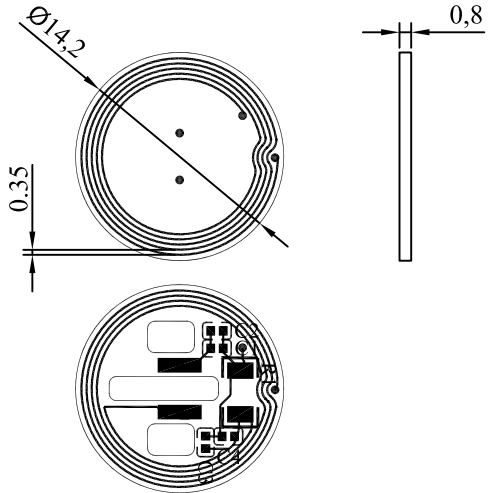

line width=0.15mm
line center distance=0.35mm
A total of 6 laps

安奈特智能技术（深圳）有限公司 Aynettek Intelligent Technology					
图号 File No.	A15天线尺寸图		客户料号 Cus' P/N	XX-X-XX-XXXX	品名 Name
未注公差 No specified tolerance			核准 Approved	单位 Unit	mm
线性 Linear	0.5~6	±0.1	审核 Checked	比例 Scale	2:1
	>6~30	±0.2			
角度 Angles	±3°		绘图 Drawing	Ekey	页码 Page
				1 / 1	