

## TEST REPORT

**Applicant:** Shenzhen ATS Electronics Technology Co., Ltd.

**Address:** 24 Bldg, Baotian Industrial Park, the Third Baotian Road, Bao'an District, Shenzhen Guangdong Province, China

**Product Name:** Motorcycle BSD Warning System

**FCC ID:** 2BEJUM7

**Standard(s):** 47 CFR Part 95, Subpart M  
ANSI C63.26-2015  
KDB 653005 D01 76-81 GHz Radars v01r02

**Report Number:** DG2240110-02152E-RF-00B

**Report Date:** 2024/4/18

The above device has been tested and found compliant with the requirement of the relative standards by Bay Area Compliance Laboratories Corp. (Dongguan).

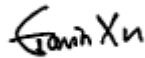

**Reviewed By:** Gavin Xu  
Title: RF Engineer



**Approved By:** Ivan Cao  
Title: EMC Manager

---

**Bay Area Compliance Laboratories Corp. (Dongguan)**  
No.12, Pulong East 1<sup>st</sup> Road, Tangxia Town, Dongguan, Guangdong, China

Tel: +86-769-86858888

Fax: +86-769-86858891

[www.baclcorp.com.cn](http://www.baclcorp.com.cn)

Note: The information marked ▲ is provided by the applicant, the laboratory is not responsible for its authenticity and this information can affect the validity of the result in the test report. Unless otherwise stated the results shown in this test report refer only to the sample(s) tested. This report cannot be reproduced except in full, without prior written approval of the Company. This report is valid only with a valid digital signature. The digital signature may be available only under the Adobe software above version 7.0. This report may contain data that are not covered by the accreditation scope and shall be marked with ★. This report must not be used by the client to claim product certification, approval, or endorsement by NVLAP, NIST, or any agency of the U.S. Government.

# CONTENTS

**DOCUMENT REVISION HISTORY ..... 4**

**1. GENERAL INFORMATION ..... 5**

**1.1 PRODUCT DESCRIPTION FOR EQUIPMENT UNDER TEST (EUT) ..... 5**

**1.2 ACCESSORY INFORMATION ..... 5**

**1.3 ANTENNA INFORMATION DETAIL ▲ ..... 5**

**1.4 EQUIPMENT MODIFICATIONS ..... 5**

**2 DESCRIPTION OF TEST CONFIGURATION ..... 6**

**2.1 EUT OPERATION CONDITION ..... 6**

**2.2 EUT EXERCISE SOFTWARE ..... 6**

**2.3 SUPPORT EQUIPMENT LIST AND DETAILS ..... 6**

**2.4 SUPPORT CABLE LIST AND DETAILS ..... 6**

**2.5 BLOCK DIAGRAM OF TEST SETUP ..... 7**

**2.6 TEST FACILITY ..... 8**

**2.7 MEASUREMENT UNCERTAINTY ..... 8**

**3. SUMMARY OF TEST RESULTS ..... 9**

**4. REQUIREMENTS AND TEST RESULTS ..... 10**

**4.1 EQUIVALENT ISOTROPICALLY RADIATED POWER (EIRP) ..... 10**

        4.1.1 Applicable Standard ..... 10

        4.1.2 EUT Setup ..... 10

        4.1.3 Test Procedure ..... 11

        4.1.4 Test Data and Result ..... 12

**4.2 UNWANTED EMISSIONS ..... 14**

        4.2.1 Applicable Standard ..... 14

        4.2.2 EUT Setup ..... 15

        4.2.3 EMI Test Receiver & Spectrum Analyzer Setup ..... 17

        4.2.4 Test Procedure ..... 18

        4.2.5 Corrected Amplitude & Margin Calculation ..... 18

        4.2.6 Test Data and Result ..... 20

**4.3 FREQUENCY STABILITY: ..... 29**

        4.3.1 Applicable Standard ..... 29

        4.3.2 EUT Setup Block Diagram ..... 29

        4.3.3 Test Procedure ..... 29

        4.3.4 Test Result ..... 30

**4.4 OCCUPIED BANDWIDTH: ..... 31**

        4.4.1 Applicable Standard ..... 31

        4.4.2 EUT Setup ..... 31

        4.4.3 Test Procedure ..... 31

        4.4.5 Test Result ..... 33

**APPENDIX A - EUT PHOTOGRAPHS ..... 35**

**APPENDIX B - TEST SETUP PHOTOGRAPHS ..... 36**

**APPENDIX C - RF EXPOSURE EVALUATION ..... 37**

---

|                                  |           |
|----------------------------------|-----------|
| <b>APPLICABLE STANDARD .....</b> | <b>37</b> |
| <b>PROCEDURE .....</b>           | <b>37</b> |

**DOCUMENT REVISION HISTORY**

---

| <b>Revision Number</b> | <b>Report Number</b>    | <b>Description of Revision</b> | <b>Date of Revision</b> |
|------------------------|-------------------------|--------------------------------|-------------------------|
| 1.0                    | DG2240110-02152E-RF-00B | Original Report                | 2024/4/18               |

# 1. GENERAL INFORMATION

## 1.1 Product Description for Equipment under Test (EUT)

|   |  |
|---|--|
| <b>EUT Name:</b>  | Motorcycle BSD Warning System                  |
| <b>EUT Model:</b>   | M7   |
| <b>Multiple Models:</b>   | M2-RD, M12-RD                                  |
| <b>Operation Frequency Range ▲:</b>   | 76.065-76.860 GHz                              |
| <b>Maximum Peak Output Power (EIRP):</b>  | 23.99 dBm                                      |
| <b>Modulation Type:</b>   | FMCW   |
| <b>Emission Designator:</b>   | N0N  |
| <b>Chirp Time ▲:</b>  | 30µs   |
| <b>Operational Temperature Range ▲:<br/>(°C)</b>  | -20~+50  |
| <b>Rated Input Voltage ▲:</b>   | DC 8-16V (Typical: DC 12V) from Vehicle system |
| <b>Serial Number:</b>   | 2GE6-2   |
| <b>EUT Received Date:</b>   | 2024/1/10                                      |
| <b>EUT Received Status:</b>   | Good   |
| <p>Note:<br/>The Multiple models are electrically identical with the test model. The difference is only the model number. Please refer to the declaration letter for more detail, which was provided by manufacturer.</p> |  |

## 1.2 Accessory Information

| Accessory Description | Manufacturer | Model | Parameters |
|-----------------------|--------------|-------|------------|
| /                     | /            | /     | /          |

## 1.3 Antenna Information Detail ▲

| Antenna Type     | Antenna Connector | Antenna Gain /Frequency Range |
|------------------|-------------------|-------------------------------|
| Microstrip Array | Integrated        | 4.78 dBi/76~77GHz             |

## 1.4 Equipment Modifications

No modifications are made to the EUT during all test items.

## 2 DESCRIPTION OF TEST CONFIGURATION

### 2.1 EUT Operation Condition

The system was configured for testing in production version, which was provided by the manufacturer. According to KDB 653005 D01 76-81 GHz Radars v01r02, the device tested at Swept mode for FMCW modulation.

### 2.2 EUT Exercise Software

No software was used during test. The maximum power was configured default setting.

### 2.3 Support Equipment List and Details

| Manufacturer | Description | Model     | Serial Number |
|--------------|-------------|-----------|---------------|
| DK           | DC Source   | DK-60V50A | T-08-EE140    |
| Lenovo       | Laptop      | T460S     | 60PDTEK81     |
| TOOMOSS      | CAN         | UTA0402   | 1MGD_2        |

### 2.4 Support Cable List and Details

| Cable Description | Shielding Type | Ferrite Core | Length(m) | From Port | To  |
|-------------------|----------------|--------------|-----------|-----------|-----|
| DC Cable          | No             | No           | 2         | DC Source | EUT |
| CAN Cable         | No             | No           | 3         | CAN       | EUT |

### 2.5 Block Diagram of Test Setup

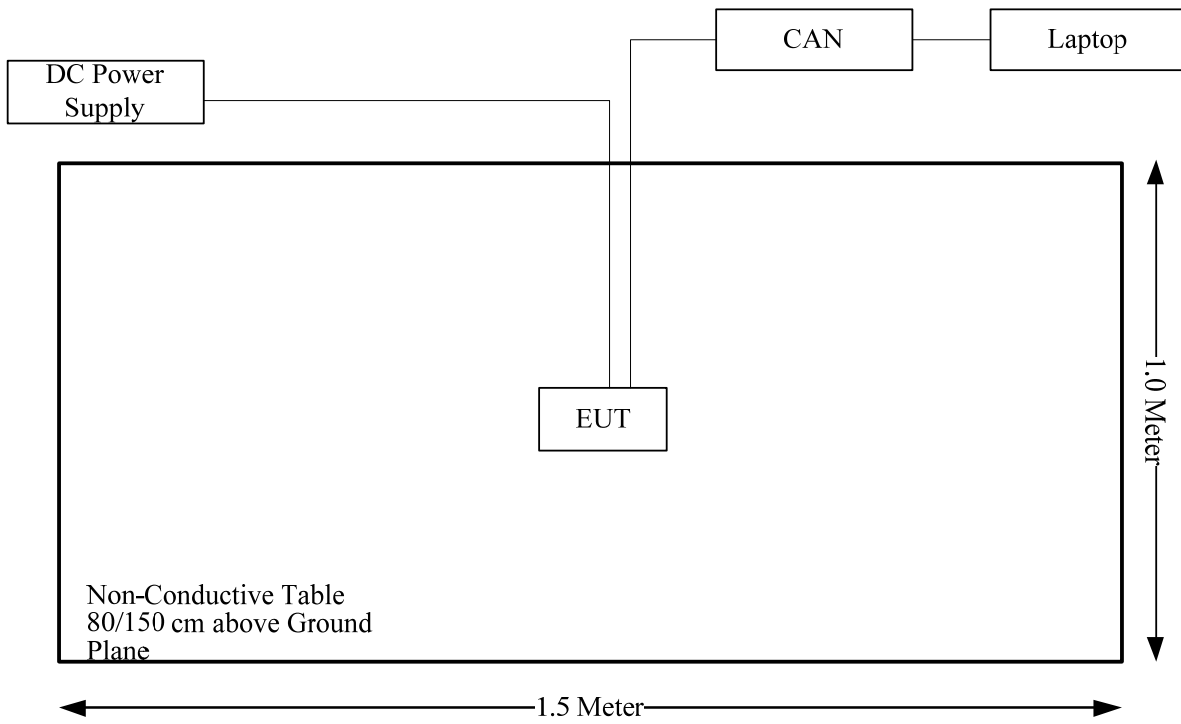

## 2.6 Test Facility

The Test site used by Bay Area Compliance Laboratories Corp. (Dongguan) to collect test data is located on the No.12, Pulong East 1st Road, Tangxia Town, Dongguan, Guangdong, China.

The lab has been recognized as the FCC accredited lab under the KDB 974614 D01 and is listed in the FCC Public Access Link (PAL) database, FCC Registration No. : 829273, the FCC Designation No. : CN5044.

The lab has been recognized by Innovation, Science and Economic Development Canada to test to Canadian radio equipment requirements, the CAB identifier: CN0022.

## 2.7 Measurement Uncertainty

Otherwise required by the applicant or Product Regulations, Decision Rule in this report did not consider the uncertainty. The extended uncertainty given in this report is obtained by combining the standard uncertainty times the coverage factor K with the 95% confidence interval.

| Parameter                         | Measurement Uncertainty  |
|-----------------------------------|--|
| Occupied Channel Bandwidth        | ±5 %   |
| Unwanted Emissions, radiated      | 9kHz~30MHz: 3.3dB, 30MHz~200MHz: 4.55 dB, 200MHz~1GHz: 5.92 dB, 1GHz~6GHz: 4.98 dB, 6GHz~18GHz: 5.89 dB, 18GHz~26.5GHz:5.47 dB, 26.5GHz~40GHz:5.63 dB, 40~60G: 4.83dB, 60G~90G: 4.94dB, 90G-140G: 5.46dB, 140G-220G: 6.00dB, 220G-325G: 7.35dB |
| EIRP                              | 4.94dB   |
| Temperature                       | ±1 °C  |
| Humidity                          | ±5%  |
| DC and low frequency voltages     | ±0.4%  |
| Duty Cycle                        | 1%   |
| AC Power Lines Conducted Emission | 3.11 dB (150 kHz to 30 MHz)  |



### 3. SUMMARY OF TEST RESULTS

| Standard(s) Section   | Test Items                                     | Result    |
|---|--|-----------|
| FCC§2.1046, §95.3367<br>KDB 653005 D01 76-81 GHz<br>Radars v01r02 | Equivalent Isotropically Radiated Power (EIRP) | Compliant |
| FCC§2.1053, §95.3379  | Unwanted Emissions                             | Compliant |
| FCC§2.1055(d), §95.3379   | Frequency Stability                            | Compliant |
| FCC§2.1049  | Occupied Bandwidth                             | Compliant |
| 2.1091, §95.3385  | RF exposure evaluation                         | Compliant |

## 4. REQUIREMENTS AND TEST RESULTS

### 4.1 Equivalent Isotropically Radiated Power (EIRP)

#### 4.1.1 Applicable Standard

FCC §2.1046, §95.3367;

The fundamental radiated emission limits within the 76-81 GHz band are expressed in terms of Equivalent Isotropically Radiated Power (EIRP) and are as follows:

(a) The maximum power (EIRP) within the 76-81 GHz band shall not exceed 50 dBm based on measurements employing a power averaging detector with a 1 MHz Resolution Bandwidth (RBW).

(b) The maximum peak power (EIRP) within the 76-81 GHz band shall not exceed 55 dBm based on measurements employing a peak detector with a 1 MHz RBW.

KDB 653005 D01 76-81 GHz Radars v01r02, Clause 4 b):

The maximum fundamental emission power (EIRP) shall be measured using a power averaging (rms) detector with a 1 MHz resolution bandwidth (RBW) and integrated over the full 99% occupied bandwidth (OBW) to obtain the data necessary to demonstrate compliance to the 50 dBm limit.

#### 4.1.2 EUT Setup

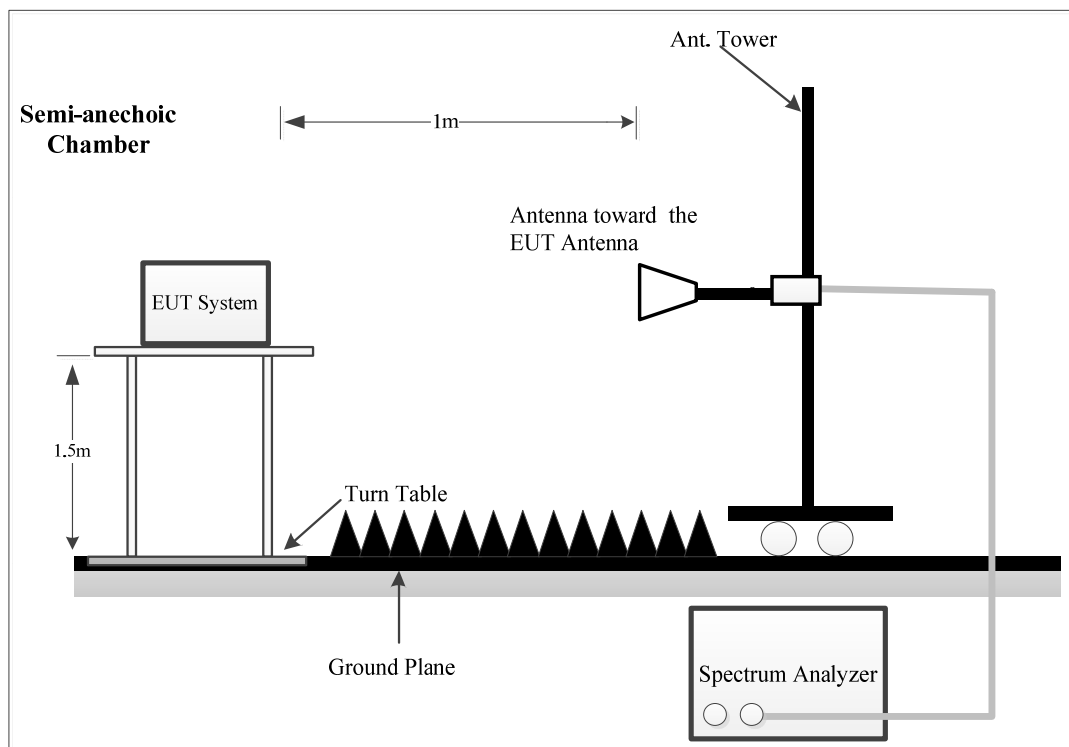

Place the measurement antenna at a measurement distance that is in the far-field of the measurement antenna, in the far-field of the EUT antenna. The EIRP test was performed at 1m distance, which was larger than the minimum test distance, please refer to section 4.2.4 for more detail.

Place the measurement antenna in the main beam of the EUT then maximize the fundamental emission, noting that multiple peaks can be found at different beam orientations and/or polarizations.

Correct the power reading from the spectrum analyzer for any external gain and/or attenuation between the measurement antenna and the spectrum analyzer.

#### 4.1.3 Test Procedure

Refer to ANSI C63.26-2015 Clause 5.2.7, KDB 653005 D01 76-81 GHz Radars v01r02

Connect the test antenna for the fundamental frequency band to a spectrum analyzer via an external mixer.

Set spectrum analyzer RBW, VBW, detector, span, and so on, to the proper values.

Maximize the fundamental emission, noting that multiple peaks may be found at different beam orientations and/or polarizations

A pulse desensitization factor must be applied to the measured peak pulse power amplitude.

Consult the relevant instrumentation manufacturers' Application Note(s) for more detailed information, including how to determine the magnitude of the FMCW- and pulse-desensitization factors.

Calculate the EIRP from the measured field strength using equation as follows:

For Peak Measurement:

$$\text{EIRP (dBm)} = E \text{ (dB}\mu\text{V/m)} + 20\log(D) - 104.8 + \text{Chirps Correction Factor}$$

For Average Measurement:

$$\text{EIRP (dBm)} = E \text{ (dB}\mu\text{V/m)} + 20\log(D) - 104.8$$

EIRP is the equivalent isotropically radiated power

E is the field strength of the emission at the measurement distance

D is the measurement distance

$$E \text{ (dB}\mu\text{V/m)} = \text{Reading (dB}\mu\text{V)} + \text{Factor (dB/m)}$$

Note: Factor includes the antenna and mixer factor, which was calibrated together.

**4.1.4 Test Data and Result**

|                |           |              |                    |
|----------------|-----------|--------------|--------------------|
| Serial Number: | 2GE6-2    | Test Date:   | 2024/2/7~2024/4/18 |
| Test Site:     | Chamber A | Test Mode:   | Transmitting       |
| Tester:        | Bill Yang | Test Result: | Pass               |

**Environmental Conditions:**

|                      |           |                           |       |                           |             |
|----------------------|-----------|---------------------------|-------|---------------------------|-------------|
| Temperature:<br>(°C) | 23.1~25.2 | Relative Humidity:<br>(%) | 62~63 | ATM<br>Pressure:<br>(kPa) | 101.2~101.3 |
|----------------------|-----------|---------------------------|-------|---------------------------|-------------|

**Test Equipment List and Details:**

| Manufacturer | Description       | Model       | Serial Number | Calibration Date | Calibration Due Date |
|--------------|-------------------|-------------|---------------|------------------|----------------------|
| OML          | Waveguide Mixer   | WR12/M12HWD | E60120-1      | 2023/2/16        | 2026/2/15            |
| OML          | Horn Antenna      | M12RH       | E60120-2      | 2023/2/27        | 2026/2/26            |
| R&S          | Spectrum Analyzer | FSV40       | 101944        | 2023/10/18       | 2024/10/17           |

\* Statement of Traceability: Bay Area Compliance Laboratories Corp. (Dongguan) attests that all calibrations have been performed, traceable to National Primary Standards and International System of Units (SI).

**Test Data:  
Peak EIRP:**

| Frequency (GHz) | Reading (dBµV) | Detector | Polar (H/V) | Factor (dB/m) | E-Field@1m (dBµV/m) | Chirps Correction Factor (dB) | EIRP (dBm) | Limit (dBm) |
|-----------------|----------------|----------|-------------|---------------|---------------------|-------------------------------|------------|-------------|
| 76.46           | 74.68          | PK       | V           | 43.43         | 118.11              | 10.68                         | 23.99      | 55          |

Refer to Application Note 1EF107-1E Rohde & Schwarz Peak and Mean Power measurements on wideband FMCW radar signals. The chirps correction factor was calculated using the formula:

$$CF_{chirp} = 5 * \log \left( 1 + K * \left( \frac{Span}{t * RBW^2} \right)^2 \right)$$

K = a correction factor for the settling process of the gaussian shaped filter (0.1947)  
t = the length of the chirp,

**Average EIRP:**

| Frequency (GHz) | Reading (dBµV) | Detector | Polar (H/V) | Factor (dB/m) | E-Field@1m (dBµV/m) | EIRP (dBm) | Limit (dBm) |
|-----------------|----------------|----------|-------------|---------------|---------------------|------------|-------------|
| 76.46           | 83.98          | AV       | V           | 43.43         | 127.41              | 22.61      | 50          |

The maximum fundamental emission power (EIRP) was measured using a power averaging (rms) detector with a 1 MHz resolution bandwidth (RBW) and integrated over the full 99% occupied bandwidth (OBW).

**Chirps Correction Factor Calculation:**

| Chirp Time ▲ (µs) | Span (MHz) | RBW (MHz) | CF <sub>chirp</sub> (dB) |
|-------------------|------------|-----------|--------------------------|
| 30                | 791.896    | 1         | 10.68                    |

**Power duty cycle:**

| Test Frequency (GHz) | Ton (ms) | Ton+off (ms) | Duty cycle (%) |
|----------------------|----------|--------------|----------------|
| 76.46                | 28.26    | 65.94        | 42.86          |

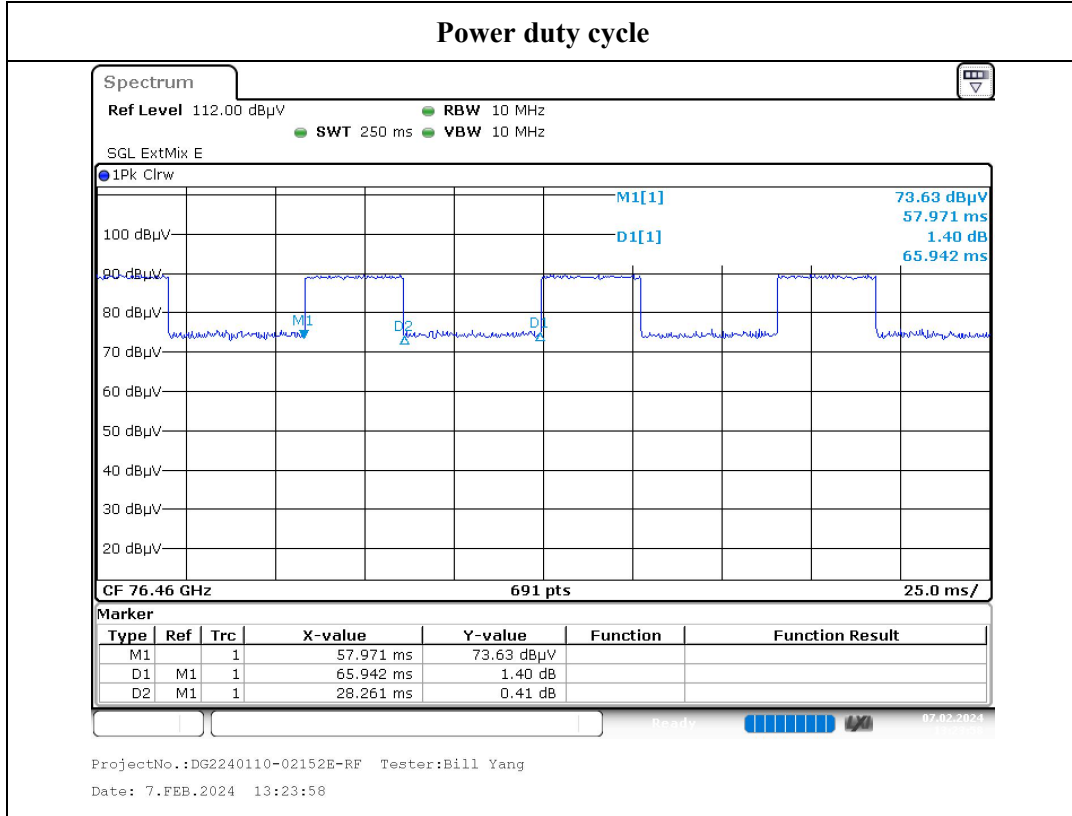

**4.2 Unwanted Emissions**

**4.2.1 Applicable Standard**

FCC §2.1053 and §95.3379;

(a) The power density of any emissions outside the 76-81 GHz band shall consist solely of spurious emissions and shall not exceed the following:

(1) Radiated emissions below 40 GHz shall not exceed the field strength as shown in the following emissions table.

| Frequency (MHz) | Field strength (microvolts/meter) | Measurement distance (meters) |
|-----------------|-----------------------------------|-------------------------------|
| 0.009-0.490     | 2400/F(kHz)                       | 300                           |
| 0.490-1.705     | 24000/F(kHz)                      | 30                            |
| 1.705-30.0      | 30                                | 30                            |
| 30-88           | 100                               | 3                             |
| 88-216          | 150                               | 3                             |
| 216-960         | 200                               | 3                             |
| Above 960       | 500                               | 3                             |

(i) In the emissions table in paragraph (a)(1) of this section, the tighter limit applies at the band edges.

(ii) The limits in the table in paragraph (a)(1) of this section are based on the frequency of the unwanted emissions and not the fundamental frequency. However, the level of any unwanted emissions shall not exceed the level of the fundamental frequency.

(iii) The emissions limits shown in the table in paragraph (a)(1) of this section are based on measurements employing a CISPR quasi-peak detector except for the frequency bands 9.0-90.0 kHz, 110.0-490.0 kHz, and above 1000 MHz. Radiated emissions limits in these three bands are based on measurements employing an average detector with a 1 MHz RBW.

(2) The power density of radiated emissions outside the 76-81 GHz band above 40.0 GHz shall not exceed the following, based on measurements employing an average detector with a 1 MHz RBW:

(i) For radiated emissions outside the 76-81 GHz band between 40 GHz and 200 GHz from field disturbance sensors and radar systems operating in the 76-81 GHz band: 600 pW/cm<sup>2</sup> at a distance of 3 meters from the exterior surface of the radiating structure.

(ii) For radiated emissions above 200 GHz from field disturbance sensors and radar systems operating in the 76-81 GHz band: 1000 pW/cm<sup>2</sup> at a distance of 3 meters from the exterior surface of the radiating structure.

(3) For field disturbance sensors and radar systems operating in the 76-81 GHz band, the spectrum shall be investigated up to 231.0 GHz.

### 4.2.2 EUT Setup

9kHz~30MHz:

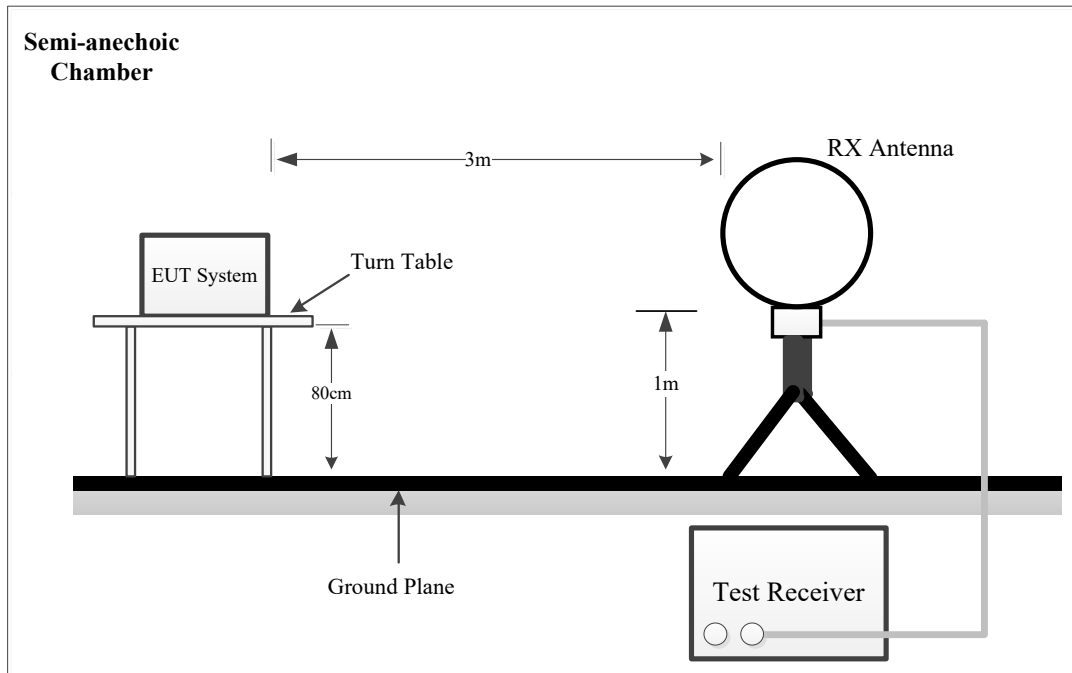

30MHz- 1GHz:

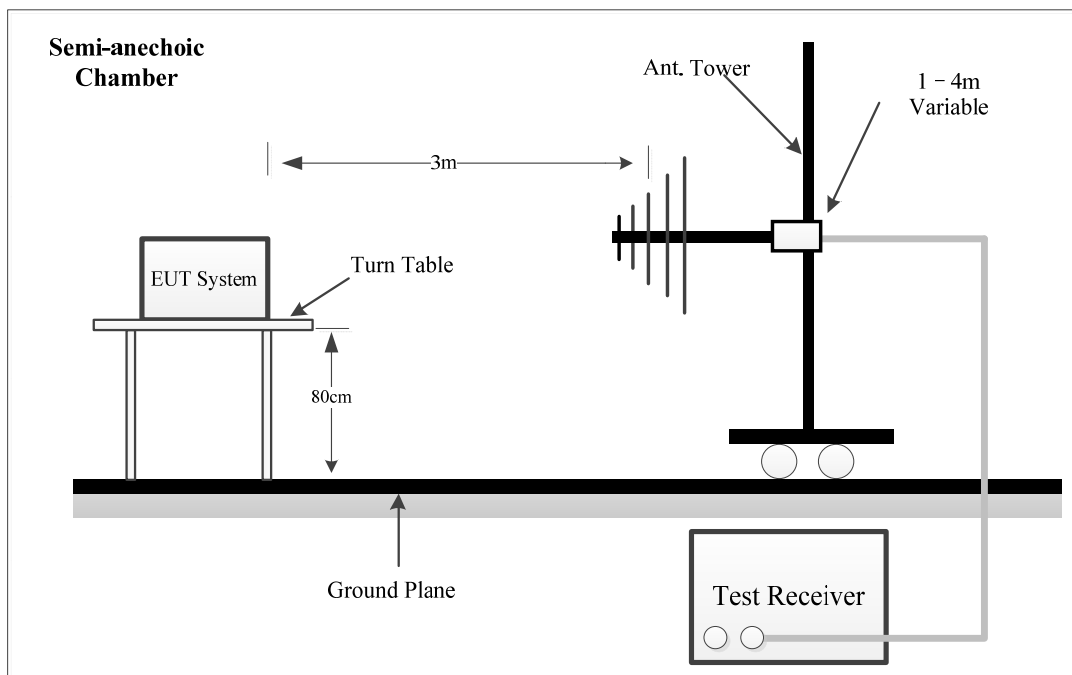

**1-40 GHz:**

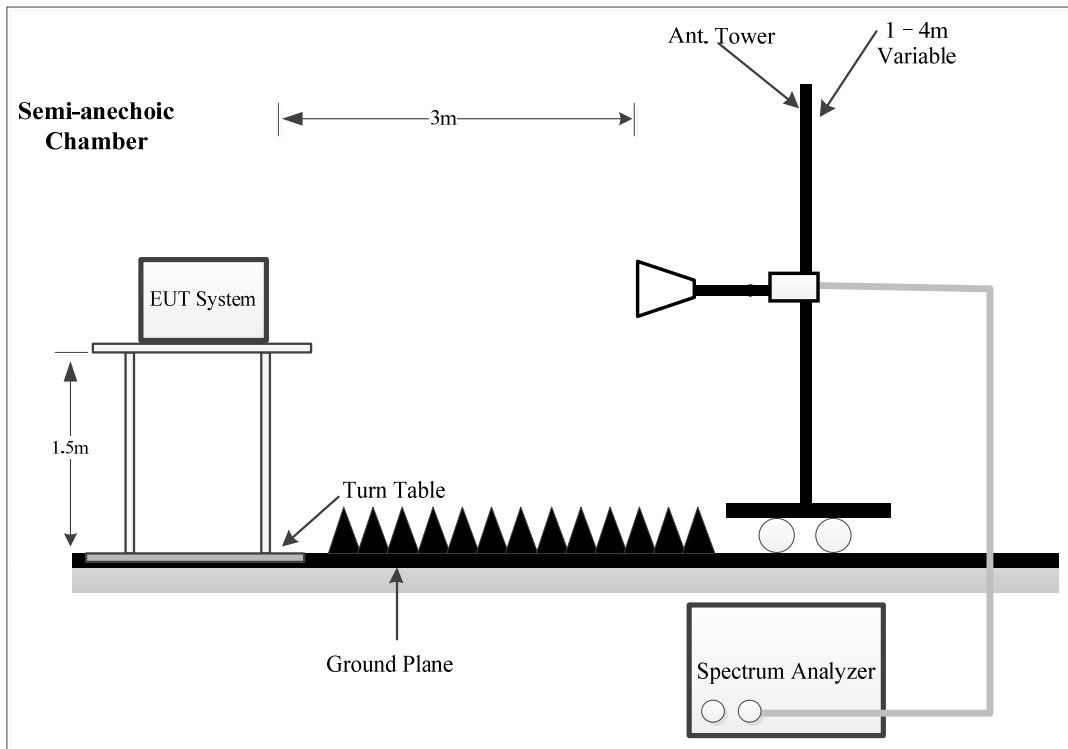

**40-90 GHz:**

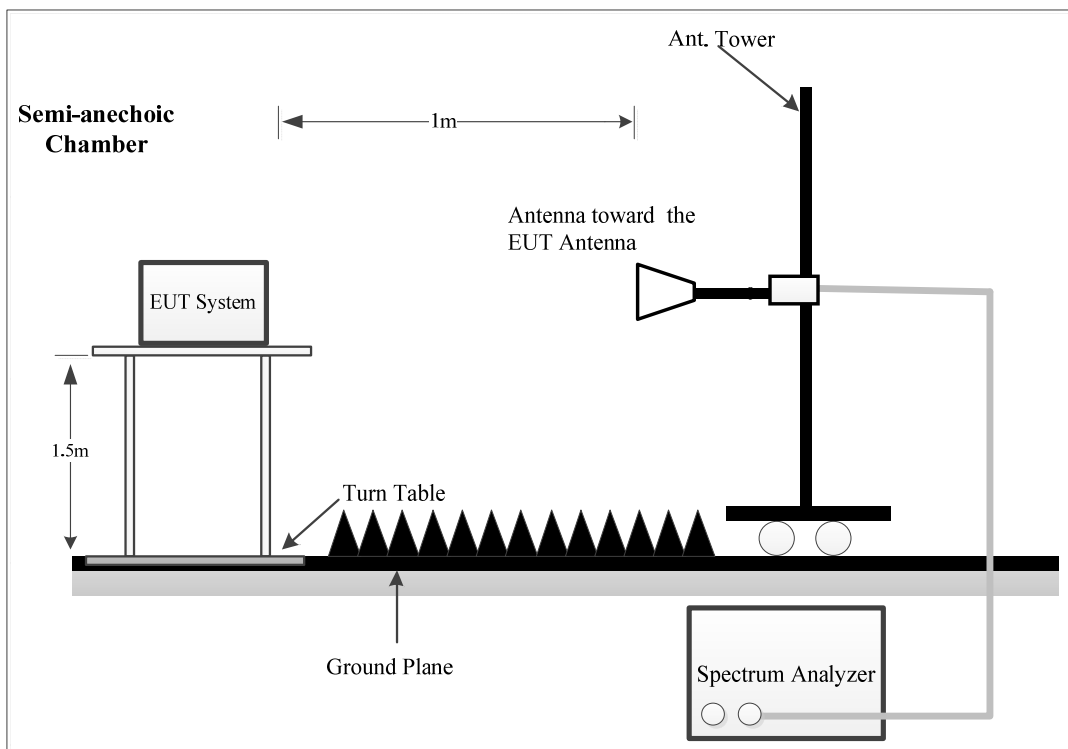



**90-231 GHz:**

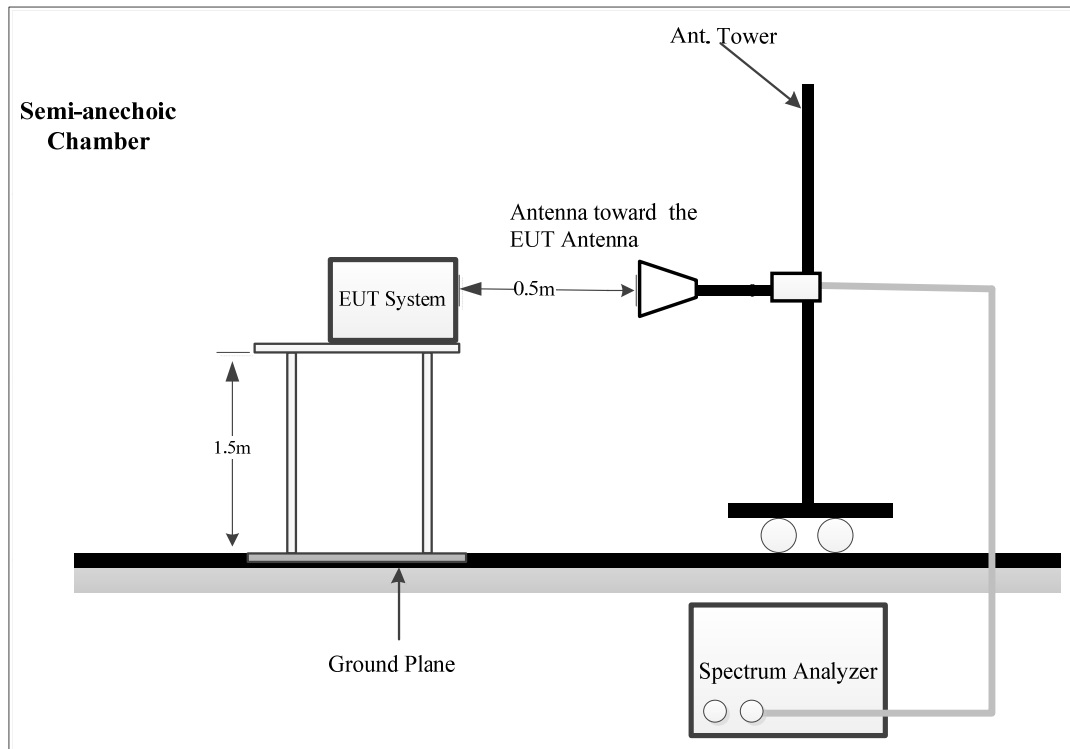

The radiated emission tests were performed in the 3 meters chamber test site, using the setup accordance with the ANSI C63.26-2015. The specification used was the FCC 95.3379 limits.

For 9kHz-30MHz test, the lowest height of the magnetic antenna shall be 1 m above the ground and three antenna orientations (parallel, perpendicular, and ground-parallel) shall be measured.

For 40-231 GHz:

Place the measurement antenna in the main beam of the EUT then maximize the fundamental emission, noting that multiple peaks can be found at different beam orientations and/or polarizations.

**4.2.3 EMI Test Receiver & Spectrum Analyzer Setup**

The system was investigated from 9kHz to 231 GHz.

During the radiated emission test, the EMI test receiver & Spectrum Analyzer Setup were set with the following configurations:

| Frequency Range   | RBW     | Video B/W | IF B/W  | Measurement |
|-------------------|---------|-----------|---------|-------------|
| 9 kHz – 150 kHz   | 200 Hz  | 1 kHz     | 200 Hz  | QP/Average  |
| 150 kHz – 30 MHz  | 9 kHz   | 30 kHz    | 9 kHz   | QP/Average  |
| 30 MHz – 1000 MHz | /       | /         | 120 kHz | QP          |
|                   | 100 kHz | 300 kHz   | /       | PK          |
| 1-40 GHz          | 1MHz    | 3 MHz     | /       | PK          |
|                   | 1MHz    | 10 Hz     | /       | Average     |
| Above 40 GHz      | 1MHz    | 3 MHz     | /       | Average     |

If the maximized peak measured value complies with under the QP/Average limit more than 6dB, then it is unnecessary to perform an QP/Average measurement.

#### 4.2.4 Test Procedure

Maximizing procedure was performed on the highest emissions to ensure that the EUT complied with all installation combinations.

Data was recorded in Quasi-peak detection mode for frequency range of 9 kHz-1 GHz except 9 – 90 kHz, 110 – 490 kHz, employing an average detector, peak and Average detection modes for frequencies above 1 GHz.

##### For above 40GHz:

External harmonic mixers are utilized. The antenna is scanned around the entire perimeter surface of the EUT, in both horizontal and vertical polarizations. The Mixers and it's RF cables is compose a system for calibration, the conversion factor was added into the test Spectrum Analyzer in testing.

The far-field boundary is given in ANSI C63.26-2015:

$$R_m = 2D^2 / \lambda$$

Where:

D is the largest dimension of the antenna aperture in m and

$\lambda$  is the free-space wavelength in m at the frequency of measurement.

The minimum test distance for the frequency range 40GHz-231GHz determine as below:

| Model | Frequency Range (GHz) | Largest Dimension of the Horn Antenna (mm) | Minimum Test Distance $R_m$ (m) |
|-------|-----------------------|--|---------------------------------|
| M19RH | 40-60                 | 46.3                                       | 0.57                            |
| M12RH | 60-90                 | 30.02                                      | 0.36                            |
| M08RH | 90-140                | 19.7                                       | 0.23                            |
| M05RH | 140-220               | 12.5                                       | 0.15                            |
| M03RH | 220-325               | 8.36                                       | 0.10                            |

Note: the test distances used were 1.0 m from 40 GHz to 90 GHz, and 0.5 m from 90 GHz to 231GHz, it can be seen that the EUT was always in the Far-field of the Receive Antenna during all Radiated Emissions Tests.

#### 4.2.5 Corrected Amplitude & Margin Calculation

For 9kHz~40GHz:

The basic equation is as follows:

Result = Reading + Factor

Factor = Antenna Factor + Cable Loss- Amplifier Gain

Note: the antenna JB3 was calibrated with 6dB Attenuator, the antenna factor includes the insertion loss of the Attenuator.

For Above 40GHz:

Field Strength = Reading + Factor

$$\text{EIRP (dBm)} = \text{Field Strength (dB}\mu\text{V/m)} + 20\log(D) - 104.8$$

D is the measurement distance

$$\text{EIRP}_{\text{Linear}} = 10^{\left[\frac{(\text{EIRP}_{\text{Log}} - 30)}{10}\right]}$$

where

$\text{EIRP}_{\text{Linear}}$  is the equivalent isotropically radiated power, in watts

$\text{EIRP}_{\text{Log}}$  is the equivalent isotropically radiated power, in dBm

$$\text{PD} = \frac{\text{EIRP}_{\text{Linear}}}{4\pi d^2}$$

where

PD is the power density at the distance specified by the limit, in  $\text{W/m}^2$

$\text{EIRP}_{\text{Linear}}$  is the equivalent isotropically radiated power, in watts

$d$  is the distance at which the power density limit is specified, in m

The Specified distance is 3m.

Note: Factor includes the antenna and mixer factor, which was calibrated together.

The “Margin” column of the following data tables indicates the degree of compliance within the applicable limit. The equation for margin calculation is as follows:

$$\text{Margin} = \text{Limit} - \text{Result}$$

**4.2.6 Test Data and Result**

|                |                       |              |  |
|----------------|-----------------------|--------------|--|
| Serial Number: | 2GE6-2                | Test Date:   | Below 1GHz: 2024/1/25~2024/3/21<br>1-40GHz: 2024/3/23<br>Above 40GHz: 2024/2/7 |
| Test Site:     | Chamber 10m           | Test Mode:   | Transmitting   |
| Tester:        | Leesin Xiang, Zoo Zou | Test Result: | Pass   |

|                                  |           |                           |       |                        |             |
|----------------------------------|-----------|---------------------------|-------|------------------------|-------------|
| <b>Environmental Conditions:</b> |           |                           |       |                        |             |
| Temperature:<br>(°C)             | 16.4~23.2 | Relative Humidity:<br>(%) | 42~53 | ATM Pressure:<br>(kPa) | 101.5~102.6 |

**Test Equipment List and Details:**

| Manufacturer          | Description          | Model                     | Serial Number     | Calibration Date | Calibration Due Date |
|-----------------------|----------------------|---------------------------|-------------------|------------------|----------------------|
| 9kHz~1000MHz          |                      |                           |                   |                  |                      |
| EMCO                  | Passive Loop Antenna | 6512                      | 9706-1206         | 2023/10/21       | 2026/10/20           |
| Sunol Sciences        | Hybrid Antenna       | JB3                       | A060611-1         | 2023/9/6         | 2026/9/5             |
| Narda                 | Attenuator           | 779-6dB                   | 04269             | 2023/9/6         | 2026/9/5             |
| Unknown               | Coaxial Cable        | C-NJNJ-50                 | C-1000-01         | 2023/8/1         | 2024/7/31            |
| Unknown               | Coaxial Cable        | C-NJNJ-50                 | C-0400-04         | 2023/8/1         | 2024/7/31            |
| Unknown               | Coaxial Cable        | C-NJNJ-50                 | C-0530-01         | 2023/8/1         | 2024/7/31            |
| Sonoma                | Amplifier            | 310N                      | 185914            | 2023/8/1         | 2024/7/31            |
| R&S                   | EMI Test Receiver    | ESCI                      | 100224            | 2023/8/18        | 2024/8/17            |
| Farad                 | Test Software        | EZ-EMC                    | V1.1.4.2          | N/A              | N/A                  |
| Above 1GHz            |                      |                           |                   |                  |                      |
| AH                    | Horn Antenna         | SAS-571                   | 1177              | 2023/2/22        | 2026/2/21            |
| Ducommun Technologies | Horn Antenna         | ARH-4223-02               | 1007726-02 1304   | 2023/2/22        | 2026/2/21            |
| Ducommun Technologies | Horn Antenna         | ARH-2823-02               | 1007726-01 1302   | 2023/2/22        | 2026/2/21            |
| HUBER+SUHNER          | Coaxial Cable        | SUCOFLEX 126EA            | MY369/26/26EA     | 2023/9/6         | 2024/9/5             |
| Xinhang Macrowave     | Coaxial Cable        | XH360A-2.92/J-2.92/J-6M-A | 20231208001 #0001 | 2023/12/11       | 2024/12/10           |
| AH                    | Preamplifier         | PAM-0118P                 | 530               | 2023/9/1         | 2024/8/31            |
| AH                    | Preamplifier         | PAM-1840VH                | 191               | 2023/9/7         | 2024/9/6             |
| R&S                   | Spectrum Analyzer    | FSV40                     | 101944            | 2023/10/18       | 2024/10/17           |
| Audix                 | Test Software        | E3                        | 191218 (V9)       | N/A              | N/A                  |
| OML                   | Waveguide Mixer      | WR19/M19HWD               | U60313-1          | 2023/2/16        | 2026/2/15            |
| OML                   | Horn Antenna         | M19RH                     | 11648-01          | 2023/2/27        | 2026/2/26            |
| OML                   | Waveguide Mixer      | WR12/M12HWD               | E60120-1          | 2023/2/16        | 2026/2/15            |
| OML                   | Horn Antenna         | M12RH                     | E60120-2          | 2023/2/27        | 2026/2/26            |
| OML                   | Waveguide Mixer      | WR08/M08HWD               | F60313-1          | 2023/2/16        | 2026/2/15            |
| OML                   | Horn Antenna         | M08RH                     | F60313-2          | 2023/2/27        | 2026/2/26            |
| OML                   | Waveguide Mixer      | WR05/M05HWD               | G60106-1          | 2023/2/16        | 2026/2/15            |
| OML                   | Horn Antenna         | M05RH                     | G60106-2          | 2023/2/27        | 2026/2/26            |
| OML                   | Waveguide Mixer      | WR03/M03HWD               | H60120-1          | 2023/2/16        | 2026/2/15            |

|  |              |       |          |           |           |
|--|--------------|-------|----------|-----------|-----------|
| OML  | Horn Antenna | M03RH | H60120-2 | 2023/2/16 | 2026/2/15 |
| <i>* Statement of Traceability: Bay Area Compliance Laboratories Corp. (Dongguan) attests that all calibrations have been performed, traceable to National Primary Standards and International System of Units (SI).</i> |              |       |          |           |           |

**Test Data:**

Please refer to the below table and plots.

After pre-scan in the X, Y and Z axes of orientation, the worst case is below:

1) 9kHz-30MHz(pretest parallel, perpendicular, and ground-parallel, the worst is below):

Project No: DG2240110-02152E-RF  
 Test Engineer: Leesin Xiang  
 Test Date: 2024-1-25  
 Polarization: Parallel  
 Test Mode: Transmitting  
 Power Source: DC 12V

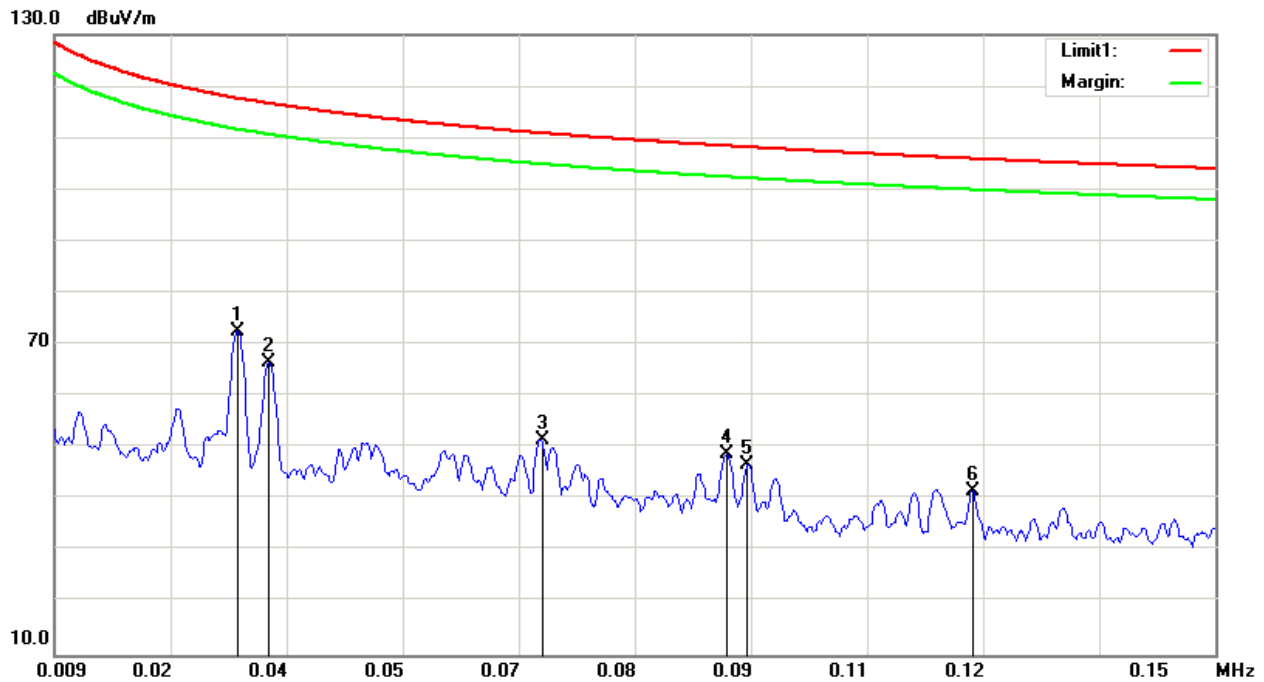

| No. | Frequency (MHz) | Reading (dBμV) | Detector | Factor (dB/m) | Result (dBμV/m) | Limit (dBμV/m) | Margin (dB) |
|-----|-----------------|----------------|----------|---------------|-----------------|----------------|-------------|
| 1   | 0.0313          | 25.31          | peak     | 47.32         | 72.63           | 117.69         | 45.06       |
| 2   | 0.0351          | 19.93          | peak     | 46.64         | 66.57           | 116.70         | 50.13       |
| 3   | 0.0681          | 10.76          | peak     | 40.92         | 51.68           | 110.94         | 59.26       |
| 4   | 0.0906          | 11.71          | peak     | 37.03         | 48.74           | 108.46         | 59.72       |
| 5   | 0.0932          | 10.20          | peak     | 36.58         | 46.78           | 108.21         | 61.43       |
| 6   | 0.1205          | 7.37           | peak     | 34.27         | 41.64           | 105.98         | 64.34       |

Project No: DG2240110-02152E-RF  
 Test Engineer: Leesin Xiang  
 Test Date: 2024-1-25  
 Polarization: Parallel  
 Test Mode: Transmitting  
 Power Source: DC 12V

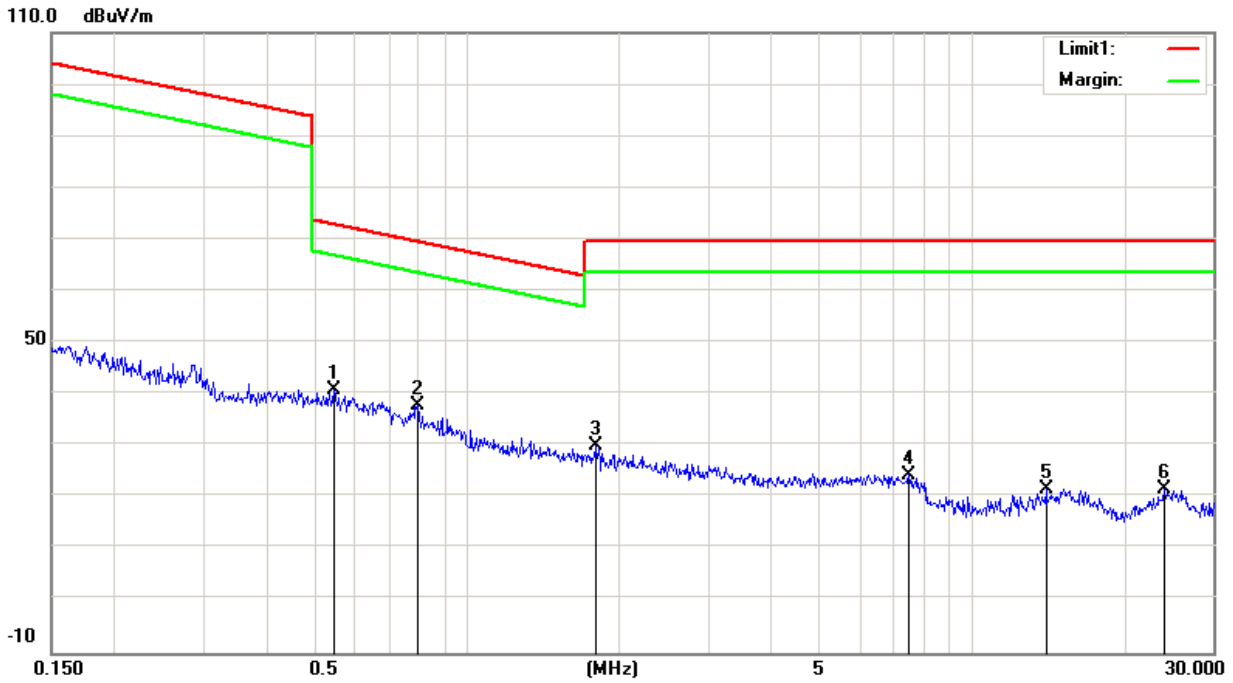

| No. | Frequency (MHz) | Reading (dBμV) | Detector | Factor (dB/m) | Result (dBμV/m) | Limit (dBμV/m) | Margin (dB) |
|-----|-----------------|----------------|----------|---------------|-----------------|----------------|-------------|
| 1   | 0.5436          | 17.86          | peak     | 23.07         | 40.93           | 72.89          | 31.96       |
| 2   | 0.7960          | 17.29          | peak     | 20.60         | 37.89           | 69.57          | 31.68       |
| 3   | 1.7905          | 17.12          | peak     | 13.05         | 30.17           | 69.54          | 39.37       |
| 4   | 7.4860          | 19.20          | peak     | 5.30          | 24.50           | 69.54          | 45.04       |
| 5   | 13.9886         | 17.19          | peak     | 4.47          | 21.66           | 69.54          | 47.88       |
| 6   | 24.0147         | 17.37          | peak     | 4.18          | 21.55           | 69.54          | 47.99       |

2)30MHz-1GHz

Project No: DG2240110-02152E-RF  
 Test Engineer: Zoo Zou  
 Test Date: 2024-3-21  
 Polarization: Horizontal  
 Test Mode: Transmitting  
 Power Source: DC 12V

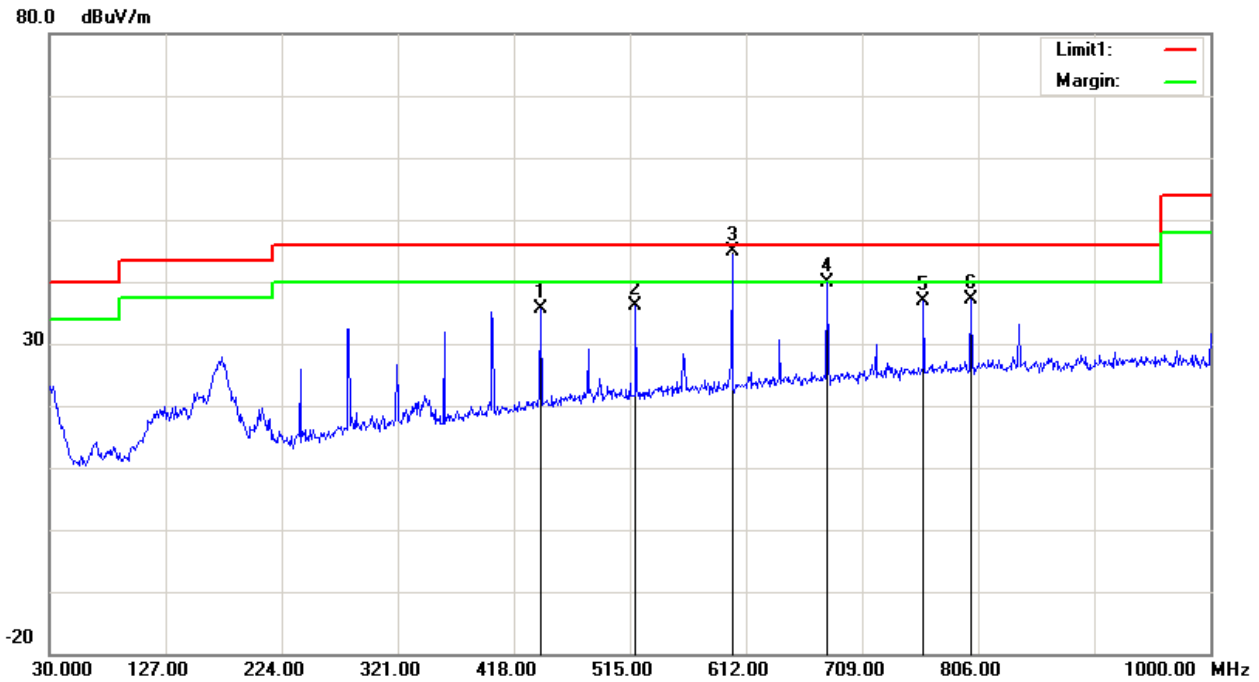

| No. | Frequency (MHz) | Reading (dBμV) | Detector | Factor (dB/m) | Result (dBμV/m) | Limit (dBμV/m) | Margin (dB) |
|-----|-----------------|----------------|----------|---------------|-----------------|----------------|-------------|
| 1   | 440.3100        | 41.29          | peak     | -5.66         | 35.63           | 46.00          | 10.37       |
| 2   | 519.8500        | 40.22          | peak     | -4.20         | 36.02           | 46.00          | 9.98        |
| 3   | 600.3600        | 47.81          | QP       | -2.91         | 44.90           | 46.00          | 1.10        |
| 4   | 679.9000        | 41.48          | peak     | -1.64         | 39.84           | 46.00          | 6.16        |
| 5   | 760.4100        | 37.16          | peak     | -0.24         | 36.92           | 46.00          | 9.08        |
| 6   | 800.1800        | 36.64          | peak     | 0.46          | 37.10           | 46.00          | 8.90        |



Project No: DG2240110-02152E-RF  
 Test Engineer: Zoo Zou  
 Test Date: 2024-3-21  
 Polarization: Vertical  
 Test Mode: Transmitting  
 Power Source: DC 12V

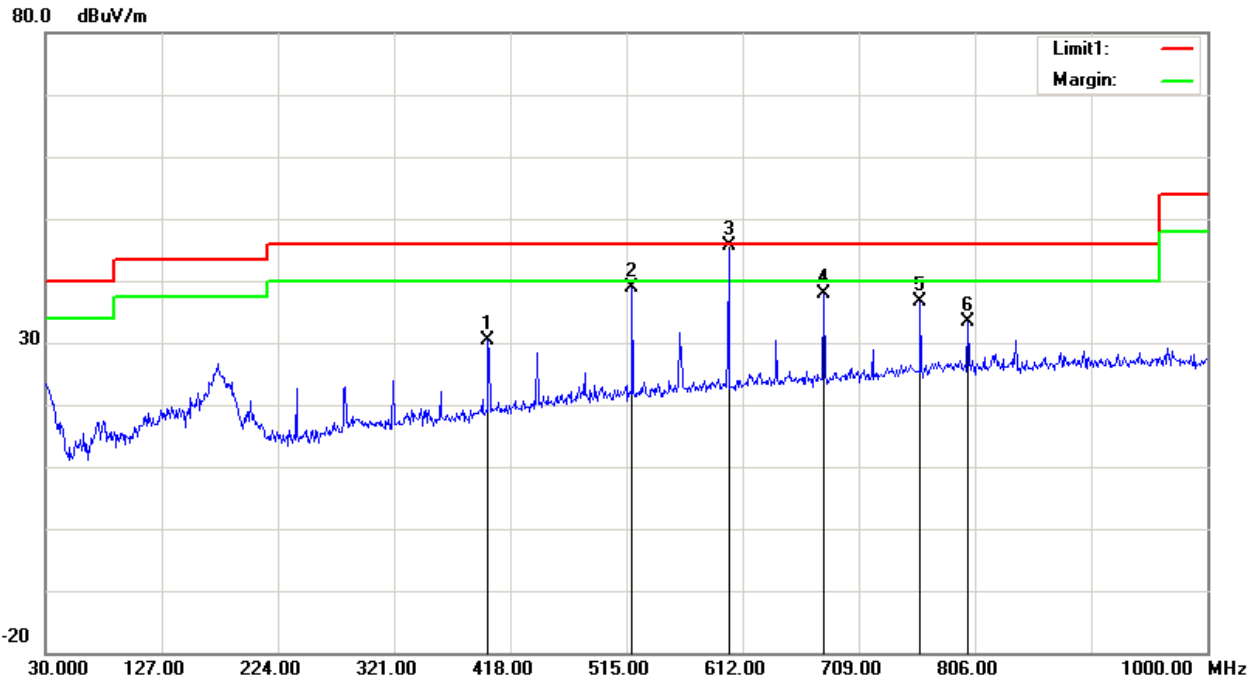

| No. | Frequency (MHz) | Reading (dBμV) | Detector | Factor (dB/m) | Result (dBμV/m) | Limit (dBμV/m) | Margin (dB) |
|-----|-----------------|----------------|----------|---------------|-----------------|----------------|-------------|
| 1   | 399.5700        | 37.38          | peak     | -6.99         | 30.39           | 46.00          | 15.61       |
| 2   | 519.8500        | 43.18          | peak     | -4.20         | 38.98           | 46.00          | 7.02        |
| 3   | 600.3600        | 48.61          | QP       | -2.91         | 45.70           | 46.00          | 0.30        |
| 4   | 679.9000        | 39.47          | peak     | -1.64         | 37.83           | 46.00          | 8.17        |
| 5   | 760.4100        | 36.76          | peak     | -0.24         | 36.52           | 46.00          | 9.48        |
| 6   | 800.1800        | 32.90          | peak     | 0.46          | 33.36           | 46.00          | 12.64       |

3) 1GHz-40GHz:

| Horizontal  |                 | Vertical       |                 |                 |                |                 |                |             |          |   |         |       |        |       |       |       |      |   |         |       |        |       |       |       |         |   |          |       |       |       |       |       |      |   |          |       |       |       |       |       |         |   |          |       |       |       |       |       |      |   |          |       |       |       |       |       |         |   |  |     |                 |                |               |                 |                |             |          |   |         |       |        |       |       |       |      |   |         |       |        |       |       |       |         |   |          |       |       |       |       |       |      |   |          |       |       |       |       |       |         |   |          |       |       |       |       |       |      |   |          |       |       |       |       |       |         |
|---|-----------------|----------------|-----------------|-----------------|----------------|-----------------|----------------|-------------|----------|---|---------|-------|--------|-------|-------|-------|------|---|---------|-------|--------|-------|-------|-------|---------|---|----------|-------|-------|-------|-------|-------|------|---|----------|-------|-------|-------|-------|-------|---------|---|----------|-------|-------|-------|-------|-------|------|---|----------|-------|-------|-------|-------|-------|---------|---|--|-----|-----------------|----------------|---------------|-----------------|----------------|-------------|----------|---|---------|-------|--------|-------|-------|-------|------|---|---------|-------|--------|-------|-------|-------|---------|---|----------|-------|-------|-------|-------|-------|------|---|----------|-------|-------|-------|-------|-------|---------|---|----------|-------|-------|-------|-------|-------|------|---|----------|-------|-------|-------|-------|-------|---------|
| <p>Project No.: DG2240110-02152E-RF      Serial No.: 26E6-2<br/>                     Polarization: Horizontal      Tester: Leesin Xiang<br/>                     Test Mode: Transmitting<br/>                     Note:</p> <p>Date: 2024-03-23</p> <p>Level (dBuV/m) vs Frequency (MHz) plot showing a blue signal line fluctuating between 30 and 50 dBuV/m, with a green AV limit line at ~55 dBuV/m and a red PK limit line at ~75 dBuV/m. Six measurement points are marked with vertical lines and numbered 1-6.</p> <table border="1"> <thead> <tr> <th>No.</th> <th>Frequency (MHz)</th> <th>Reading (dBuV)</th> <th>Factor (dB/m)</th> <th>Result (dBuV/m)</th> <th>Limit (dBuV/m)</th> <th>Margin (dB)</th> <th>Detector</th> </tr> </thead> <tbody> <tr><td>1</td><td>3398.55</td><td>54.73</td><td>-12.19</td><td>42.54</td><td>74.00</td><td>31.46</td><td>Peak</td></tr> <tr><td>2</td><td>3398.55</td><td>42.38</td><td>-12.19</td><td>30.19</td><td>54.00</td><td>23.81</td><td>Average</td></tr> <tr><td>3</td><td>4782.61</td><td>54.45</td><td>-8.83</td><td>45.62</td><td>74.00</td><td>28.38</td><td>Peak</td></tr> <tr><td>4</td><td>4782.61</td><td>42.62</td><td>-8.83</td><td>33.79</td><td>54.00</td><td>20.21</td><td>Average</td></tr> <tr><td>5</td><td>5514.49</td><td>55.48</td><td>-8.75</td><td>46.73</td><td>74.00</td><td>27.27</td><td>Peak</td></tr> <tr><td>6</td><td>5514.49</td><td>43.27</td><td>-8.75</td><td>34.52</td><td>54.00</td><td>19.48</td><td>Average</td></tr> </tbody> </table> |                 | No.            | Frequency (MHz) | Reading (dBuV)  | Factor (dB/m)  | Result (dBuV/m) | Limit (dBuV/m) | Margin (dB) | Detector | 1 | 3398.55 | 54.73 | -12.19 | 42.54 | 74.00 | 31.46 | Peak | 2 | 3398.55 | 42.38 | -12.19 | 30.19 | 54.00 | 23.81 | Average | 3 | 4782.61  | 54.45 | -8.83 | 45.62 | 74.00 | 28.38 | Peak | 4 | 4782.61  | 42.62 | -8.83 | 33.79 | 54.00 | 20.21 | Average | 5 | 5514.49  | 55.48 | -8.75 | 46.73 | 74.00 | 27.27 | Peak | 6 | 5514.49  | 43.27 | -8.75 | 34.52 | 54.00 | 19.48 | Average | <p>Project No.: DG2240110-02152E-RF      Serial No.: 26E6-2<br/>                     Polarization: Vertical      Tester: Leesin Xiang<br/>                     Test Mode: Transmitting<br/>                     Note:</p> <p>Date: 2024-03-23</p> <p>Level (dBuV/m) vs Frequency (MHz) plot showing a blue signal line fluctuating between 30 and 50 dBuV/m, with a green AV limit line at ~55 dBuV/m and a red PK limit line at ~75 dBuV/m. Six measurement points are marked with vertical lines and numbered 1-6.</p> <table border="1"> <thead> <tr> <th>No.</th> <th>Frequency (MHz)</th> <th>Reading (dBuV)</th> <th>Factor (dB/m)</th> <th>Result (dBuV/m)</th> <th>Limit (dBuV/m)</th> <th>Margin (dB)</th> <th>Detector</th> </tr> </thead> <tbody> <tr><td>1</td><td>3079.71</td><td>53.35</td><td>-12.79</td><td>40.56</td><td>74.00</td><td>33.44</td><td>Peak</td></tr> <tr><td>2</td><td>3079.71</td><td>41.52</td><td>-12.79</td><td>28.73</td><td>54.00</td><td>25.27</td><td>Average</td></tr> <tr><td>3</td><td>4862.32</td><td>54.01</td><td>-8.59</td><td>45.42</td><td>74.00</td><td>28.58</td><td>Peak</td></tr> <tr><td>4</td><td>4862.32</td><td>42.84</td><td>-8.59</td><td>34.25</td><td>54.00</td><td>19.75</td><td>Average</td></tr> <tr><td>5</td><td>5456.52</td><td>55.19</td><td>-8.67</td><td>46.52</td><td>74.00</td><td>27.48</td><td>Peak</td></tr> <tr><td>6</td><td>5456.52</td><td>43.18</td><td>-8.67</td><td>34.51</td><td>54.00</td><td>19.49</td><td>Average</td></tr> </tbody> </table> |  | No. | Frequency (MHz) | Reading (dBuV) | Factor (dB/m) | Result (dBuV/m) | Limit (dBuV/m) | Margin (dB) | Detector | 1 | 3079.71 | 53.35 | -12.79 | 40.56 | 74.00 | 33.44 | Peak | 2 | 3079.71 | 41.52 | -12.79 | 28.73 | 54.00 | 25.27 | Average | 3 | 4862.32  | 54.01 | -8.59 | 45.42 | 74.00 | 28.58 | Peak | 4 | 4862.32  | 42.84 | -8.59 | 34.25 | 54.00 | 19.75 | Average | 5 | 5456.52  | 55.19 | -8.67 | 46.52 | 74.00 | 27.48 | Peak | 6 | 5456.52  | 43.18 | -8.67 | 34.51 | 54.00 | 19.49 | Average |
| No.   | Frequency (MHz) | Reading (dBuV) | Factor (dB/m)   | Result (dBuV/m) | Limit (dBuV/m) | Margin (dB)     | Detector       |             |          |   |         |       |        |       |       |       |      |   |         |       |        |       |       |       |         |   |          |       |       |       |       |       |      |   |          |       |       |       |       |       |         |   |          |       |       |       |       |       |      |   |          |       |       |       |       |       |         |   |  |     |                 |                |               |                 |                |             |          |   |         |       |        |       |       |       |      |   |         |       |        |       |       |       |         |   |          |       |       |       |       |       |      |   |          |       |       |       |       |       |         |   |          |       |       |       |       |       |      |   |          |       |       |       |       |       |         |
| 1   | 3398.55         | 54.73          | -12.19          | 42.54           | 74.00          | 31.46           | Peak           |             |          |   |         |       |        |       |       |       |      |   |         |       |        |       |       |       |         |   |          |       |       |       |       |       |      |   |          |       |       |       |       |       |         |   |          |       |       |       |       |       |      |   |          |       |       |       |       |       |         |   |  |     |                 |                |               |                 |                |             |          |   |         |       |        |       |       |       |      |   |         |       |        |       |       |       |         |   |          |       |       |       |       |       |      |   |          |       |       |       |       |       |         |   |          |       |       |       |       |       |      |   |          |       |       |       |       |       |         |
| 2   | 3398.55         | 42.38          | -12.19          | 30.19           | 54.00          | 23.81           | Average        |             |          |   |         |       |        |       |       |       |      |   |         |       |        |       |       |       |         |   |          |       |       |       |       |       |      |   |          |       |       |       |       |       |         |   |          |       |       |       |       |       |      |   |          |       |       |       |       |       |         |   |  |     |                 |                |               |                 |                |             |          |   |         |       |        |       |       |       |      |   |         |       |        |       |       |       |         |   |          |       |       |       |       |       |      |   |          |       |       |       |       |       |         |   |          |       |       |       |       |       |      |   |          |       |       |       |       |       |         |
| 3   | 4782.61         | 54.45          | -8.83           | 45.62           | 74.00          | 28.38           | Peak           |             |          |   |         |       |        |       |       |       |      |   |         |       |        |       |       |       |         |   |          |       |       |       |       |       |      |   |          |       |       |       |       |       |         |   |          |       |       |       |       |       |      |   |          |       |       |       |       |       |         |   |  |     |                 |                |               |                 |                |             |          |   |         |       |        |       |       |       |      |   |         |       |        |       |       |       |         |   |          |       |       |       |       |       |      |   |          |       |       |       |       |       |         |   |          |       |       |       |       |       |      |   |          |       |       |       |       |       |         |
| 4   | 4782.61         | 42.62          | -8.83           | 33.79           | 54.00          | 20.21           | Average        |             |          |   |         |       |        |       |       |       |      |   |         |       |        |       |       |       |         |   |          |       |       |       |       |       |      |   |          |       |       |       |       |       |         |   |          |       |       |       |       |       |      |   |          |       |       |       |       |       |         |   |  |     |                 |                |               |                 |                |             |          |   |         |       |        |       |       |       |      |   |         |       |        |       |       |       |         |   |          |       |       |       |       |       |      |   |          |       |       |       |       |       |         |   |          |       |       |       |       |       |      |   |          |       |       |       |       |       |         |
| 5   | 5514.49         | 55.48          | -8.75           | 46.73           | 74.00          | 27.27           | Peak           |             |          |   |         |       |        |       |       |       |      |   |         |       |        |       |       |       |         |   |          |       |       |       |       |       |      |   |          |       |       |       |       |       |         |   |          |       |       |       |       |       |      |   |          |       |       |       |       |       |         |   |  |     |                 |                |               |                 |                |             |          |   |         |       |        |       |       |       |      |   |         |       |        |       |       |       |         |   |          |       |       |       |       |       |      |   |          |       |       |       |       |       |         |   |          |       |       |       |       |       |      |   |          |       |       |       |       |       |         |
| 6   | 5514.49         | 43.27          | -8.75           | 34.52           | 54.00          | 19.48           | Average        |             |          |   |         |       |        |       |       |       |      |   |         |       |        |       |       |       |         |   |          |       |       |       |       |       |      |   |          |       |       |       |       |       |         |   |          |       |       |       |       |       |      |   |          |       |       |       |       |       |         |   |  |     |                 |                |               |                 |                |             |          |   |         |       |        |       |       |       |      |   |         |       |        |       |       |       |         |   |          |       |       |       |       |       |      |   |          |       |       |       |       |       |         |   |          |       |       |       |       |       |      |   |          |       |       |       |       |       |         |
| No.   | Frequency (MHz) | Reading (dBuV) | Factor (dB/m)   | Result (dBuV/m) | Limit (dBuV/m) | Margin (dB)     | Detector       |             |          |   |         |       |        |       |       |       |      |   |         |       |        |       |       |       |         |   |          |       |       |       |       |       |      |   |          |       |       |       |       |       |         |   |          |       |       |       |       |       |      |   |          |       |       |       |       |       |         |   |  |     |                 |                |               |                 |                |             |          |   |         |       |        |       |       |       |      |   |         |       |        |       |       |       |         |   |          |       |       |       |       |       |      |   |          |       |       |       |       |       |         |   |          |       |       |       |       |       |      |   |          |       |       |       |       |       |         |
| 1   | 3079.71         | 53.35          | -12.79          | 40.56           | 74.00          | 33.44           | Peak           |             |          |   |         |       |        |       |       |       |      |   |         |       |        |       |       |       |         |   |          |       |       |       |       |       |      |   |          |       |       |       |       |       |         |   |          |       |       |       |       |       |      |   |          |       |       |       |       |       |         |   |  |     |                 |                |               |                 |                |             |          |   |         |       |        |       |       |       |      |   |         |       |        |       |       |       |         |   |          |       |       |       |       |       |      |   |          |       |       |       |       |       |         |   |          |       |       |       |       |       |      |   |          |       |       |       |       |       |         |
| 2   | 3079.71         | 41.52          | -12.79          | 28.73           | 54.00          | 25.27           | Average        |             |          |   |         |       |        |       |       |       |      |   |         |       |        |       |       |       |         |   |          |       |       |       |       |       |      |   |          |       |       |       |       |       |         |   |          |       |       |       |       |       |      |   |          |       |       |       |       |       |         |   |  |     |                 |                |               |                 |                |             |          |   |         |       |        |       |       |       |      |   |         |       |        |       |       |       |         |   |          |       |       |       |       |       |      |   |          |       |       |       |       |       |         |   |          |       |       |       |       |       |      |   |          |       |       |       |       |       |         |
| 3   | 4862.32         | 54.01          | -8.59           | 45.42           | 74.00          | 28.58           | Peak           |             |          |   |         |       |        |       |       |       |      |   |         |       |        |       |       |       |         |   |          |       |       |       |       |       |      |   |          |       |       |       |       |       |         |   |          |       |       |       |       |       |      |   |          |       |       |       |       |       |         |   |  |     |                 |                |               |                 |                |             |          |   |         |       |        |       |       |       |      |   |         |       |        |       |       |       |         |   |          |       |       |       |       |       |      |   |          |       |       |       |       |       |         |   |          |       |       |       |       |       |      |   |          |       |       |       |       |       |         |
| 4   | 4862.32         | 42.84          | -8.59           | 34.25           | 54.00          | 19.75           | Average        |             |          |   |         |       |        |       |       |       |      |   |         |       |        |       |       |       |         |   |          |       |       |       |       |       |      |   |          |       |       |       |       |       |         |   |          |       |       |       |       |       |      |   |          |       |       |       |       |       |         |   |  |     |                 |                |               |                 |                |             |          |   |         |       |        |       |       |       |      |   |         |       |        |       |       |       |         |   |          |       |       |       |       |       |      |   |          |       |       |       |       |       |         |   |          |       |       |       |       |       |      |   |          |       |       |       |       |       |         |
| 5   | 5456.52         | 55.19          | -8.67           | 46.52           | 74.00          | 27.48           | Peak           |             |          |   |         |       |        |       |       |       |      |   |         |       |        |       |       |       |         |   |          |       |       |       |       |       |      |   |          |       |       |       |       |       |         |   |          |       |       |       |       |       |      |   |          |       |       |       |       |       |         |   |  |     |                 |                |               |                 |                |             |          |   |         |       |        |       |       |       |      |   |         |       |        |       |       |       |         |   |          |       |       |       |       |       |      |   |          |       |       |       |       |       |         |   |          |       |       |       |       |       |      |   |          |       |       |       |       |       |         |
| 6   | 5456.52         | 43.18          | -8.67           | 34.51           | 54.00          | 19.49           | Average        |             |          |   |         |       |        |       |       |       |      |   |         |       |        |       |       |       |         |   |          |       |       |       |       |       |      |   |          |       |       |       |       |       |         |   |          |       |       |       |       |       |      |   |          |       |       |       |       |       |         |   |  |     |                 |                |               |                 |                |             |          |   |         |       |        |       |       |       |      |   |         |       |        |       |       |       |         |   |          |       |       |       |       |       |      |   |          |       |       |       |       |       |         |   |          |       |       |       |       |       |      |   |          |       |       |       |       |       |         |
| <p>Project No.: DG2240110-02152E-RF      Serial No.: 26E6-2<br/>                     Polarization: Horizontal      Tester: Leesin Xiang<br/>                     Test Mode: Transmitting<br/>                     Note:</p> <p>Date: 2024-03-23</p> <p>Level (dBuV/m) vs Frequency (MHz) plot showing a blue signal line fluctuating between 40 and 60 dBuV/m, with a green AV limit line at ~55 dBuV/m and a red PK limit line at ~75 dBuV/m. Six measurement points are marked with vertical lines and numbered 1-6.</p> <table border="1"> <thead> <tr> <th>No.</th> <th>Frequency (MHz)</th> <th>Reading (dBuV)</th> <th>Factor (dB/m)</th> <th>Result (dBuV/m)</th> <th>Limit (dBuV/m)</th> <th>Margin (dB)</th> <th>Detector</th> </tr> </thead> <tbody> <tr><td>1</td><td>7200.00</td><td>58.00</td><td>-5.06</td><td>52.94</td><td>74.00</td><td>21.06</td><td>Peak</td></tr> <tr><td>2</td><td>7200.00</td><td>55.06</td><td>-5.06</td><td>50.00</td><td>54.00</td><td>4.00</td><td>Average</td></tr> <tr><td>3</td><td>17095.65</td><td>53.79</td><td>5.77</td><td>59.56</td><td>74.00</td><td>14.44</td><td>Peak</td></tr> <tr><td>4</td><td>17095.65</td><td>41.13</td><td>5.77</td><td>46.90</td><td>54.00</td><td>7.10</td><td>Average</td></tr> <tr><td>5</td><td>17982.61</td><td>52.30</td><td>8.59</td><td>60.89</td><td>74.00</td><td>13.11</td><td>Peak</td></tr> <tr><td>6</td><td>17982.61</td><td>39.12</td><td>8.59</td><td>47.71</td><td>54.00</td><td>6.29</td><td>Average</td></tr> </tbody> </table>      |                 | No.            | Frequency (MHz) | Reading (dBuV)  | Factor (dB/m)  | Result (dBuV/m) | Limit (dBuV/m) | Margin (dB) | Detector | 1 | 7200.00 | 58.00 | -5.06  | 52.94 | 74.00 | 21.06 | Peak | 2 | 7200.00 | 55.06 | -5.06  | 50.00 | 54.00 | 4.00  | Average | 3 | 17095.65 | 53.79 | 5.77  | 59.56 | 74.00 | 14.44 | Peak | 4 | 17095.65 | 41.13 | 5.77  | 46.90 | 54.00 | 7.10  | Average | 5 | 17982.61 | 52.30 | 8.59  | 60.89 | 74.00 | 13.11 | Peak | 6 | 17982.61 | 39.12 | 8.59  | 47.71 | 54.00 | 6.29  | Average | <p>Project No.: DG2240110-02152E-RF      Serial No.: 26E6-2<br/>                     Polarization: Vertical      Tester: Leesin Xiang<br/>                     Test Mode: Transmitting<br/>                     Note:</p> <p>Date: 2024-03-23</p> <p>Level (dBuV/m) vs Frequency (MHz) plot showing a blue signal line fluctuating between 40 and 60 dBuV/m, with a green AV limit line at ~55 dBuV/m and a red PK limit line at ~75 dBuV/m. Six measurement points are marked with vertical lines and numbered 1-6.</p> <table border="1"> <thead> <tr> <th>No.</th> <th>Frequency (MHz)</th> <th>Reading (dBuV)</th> <th>Factor (dB/m)</th> <th>Result (dBuV/m)</th> <th>Limit (dBuV/m)</th> <th>Margin (dB)</th> <th>Detector</th> </tr> </thead> <tbody> <tr><td>1</td><td>7200.00</td><td>60.15</td><td>-5.06</td><td>55.09</td><td>74.00</td><td>18.91</td><td>Peak</td></tr> <tr><td>2</td><td>7200.00</td><td>55.68</td><td>-5.06</td><td>50.62</td><td>54.00</td><td>3.38</td><td>Average</td></tr> <tr><td>3</td><td>16939.13</td><td>54.51</td><td>5.32</td><td>59.83</td><td>74.00</td><td>14.17</td><td>Peak</td></tr> <tr><td>4</td><td>16939.13</td><td>41.96</td><td>5.32</td><td>47.28</td><td>54.00</td><td>6.72</td><td>Average</td></tr> <tr><td>5</td><td>17582.61</td><td>54.45</td><td>7.00</td><td>61.45</td><td>74.00</td><td>12.55</td><td>Peak</td></tr> <tr><td>6</td><td>17582.61</td><td>40.53</td><td>7.00</td><td>47.53</td><td>54.00</td><td>6.47</td><td>Average</td></tr> </tbody> </table>      |  | No. | Frequency (MHz) | Reading (dBuV) | Factor (dB/m) | Result (dBuV/m) | Limit (dBuV/m) | Margin (dB) | Detector | 1 | 7200.00 | 60.15 | -5.06  | 55.09 | 74.00 | 18.91 | Peak | 2 | 7200.00 | 55.68 | -5.06  | 50.62 | 54.00 | 3.38  | Average | 3 | 16939.13 | 54.51 | 5.32  | 59.83 | 74.00 | 14.17 | Peak | 4 | 16939.13 | 41.96 | 5.32  | 47.28 | 54.00 | 6.72  | Average | 5 | 17582.61 | 54.45 | 7.00  | 61.45 | 74.00 | 12.55 | Peak | 6 | 17582.61 | 40.53 | 7.00  | 47.53 | 54.00 | 6.47  | Average |
| No.   | Frequency (MHz) | Reading (dBuV) | Factor (dB/m)   | Result (dBuV/m) | Limit (dBuV/m) | Margin (dB)     | Detector       |             |          |   |         |       |        |       |       |       |      |   |         |       |        |       |       |       |         |   |          |       |       |       |       |       |      |   |          |       |       |       |       |       |         |   |          |       |       |       |       |       |      |   |          |       |       |       |       |       |         |   |  |     |                 |                |               |                 |                |             |          |   |         |       |        |       |       |       |      |   |         |       |        |       |       |       |         |   |          |       |       |       |       |       |      |   |          |       |       |       |       |       |         |   |          |       |       |       |       |       |      |   |          |       |       |       |       |       |         |
| 1   | 7200.00         | 58.00          | -5.06           | 52.94           | 74.00          | 21.06           | Peak           |             |          |   |         |       |        |       |       |       |      |   |         |       |        |       |       |       |         |   |          |       |       |       |       |       |      |   |          |       |       |       |       |       |         |   |          |       |       |       |       |       |      |   |          |       |       |       |       |       |         |   |  |     |                 |                |               |                 |                |             |          |   |         |       |        |       |       |       |      |   |         |       |        |       |       |       |         |   |          |       |       |       |       |       |      |   |          |       |       |       |       |       |         |   |          |       |       |       |       |       |      |   |          |       |       |       |       |       |         |
| 2   | 7200.00         | 55.06          | -5.06           | 50.00           | 54.00          | 4.00            | Average        |             |          |   |         |       |        |       |       |       |      |   |         |       |        |       |       |       |         |   |          |       |       |       |       |       |      |   |          |       |       |       |       |       |         |   |          |       |       |       |       |       |      |   |          |       |       |       |       |       |         |   |  |     |                 |                |               |                 |                |             |          |   |         |       |        |       |       |       |      |   |         |       |        |       |       |       |         |   |          |       |       |       |       |       |      |   |          |       |       |       |       |       |         |   |          |       |       |       |       |       |      |   |          |       |       |       |       |       |         |
| 3   | 17095.65        | 53.79          | 5.77            | 59.56           | 74.00          | 14.44           | Peak           |             |          |   |         |       |        |       |       |       |      |   |         |       |        |       |       |       |         |   |          |       |       |       |       |       |      |   |          |       |       |       |       |       |         |   |          |       |       |       |       |       |      |   |          |       |       |       |       |       |         |   |  |     |                 |                |               |                 |                |             |          |   |         |       |        |       |       |       |      |   |         |       |        |       |       |       |         |   |          |       |       |       |       |       |      |   |          |       |       |       |       |       |         |   |          |       |       |       |       |       |      |   |          |       |       |       |       |       |         |
| 4   | 17095.65        | 41.13          | 5.77            | 46.90           | 54.00          | 7.10            | Average        |             |          |   |         |       |        |       |       |       |      |   |         |       |        |       |       |       |         |   |          |       |       |       |       |       |      |   |          |       |       |       |       |       |         |   |          |       |       |       |       |       |      |   |          |       |       |       |       |       |         |   |  |     |                 |                |               |                 |                |             |          |   |         |       |        |       |       |       |      |   |         |       |        |       |       |       |         |   |          |       |       |       |       |       |      |   |          |       |       |       |       |       |         |   |          |       |       |       |       |       |      |   |          |       |       |       |       |       |         |
| 5   | 17982.61        | 52.30          | 8.59            | 60.89           | 74.00          | 13.11           | Peak           |             |          |   |         |       |        |       |       |       |      |   |         |       |        |       |       |       |         |   |          |       |       |       |       |       |      |   |          |       |       |       |       |       |         |   |          |       |       |       |       |       |      |   |          |       |       |       |       |       |         |   |  |     |                 |                |               |                 |                |             |          |   |         |       |        |       |       |       |      |   |         |       |        |       |       |       |         |   |          |       |       |       |       |       |      |   |          |       |       |       |       |       |         |   |          |       |       |       |       |       |      |   |          |       |       |       |       |       |         |
| 6   | 17982.61        | 39.12          | 8.59            | 47.71           | 54.00          | 6.29            | Average        |             |          |   |         |       |        |       |       |       |      |   |         |       |        |       |       |       |         |   |          |       |       |       |       |       |      |   |          |       |       |       |       |       |         |   |          |       |       |       |       |       |      |   |          |       |       |       |       |       |         |   |  |     |                 |                |               |                 |                |             |          |   |         |       |        |       |       |       |      |   |         |       |        |       |       |       |         |   |          |       |       |       |       |       |      |   |          |       |       |       |       |       |         |   |          |       |       |       |       |       |      |   |          |       |       |       |       |       |         |
| No.   | Frequency (MHz) | Reading (dBuV) | Factor (dB/m)   | Result (dBuV/m) | Limit (dBuV/m) | Margin (dB)     | Detector       |             |          |   |         |       |        |       |       |       |      |   |         |       |        |       |       |       |         |   |          |       |       |       |       |       |      |   |          |       |       |       |       |       |         |   |          |       |       |       |       |       |      |   |          |       |       |       |       |       |         |   |  |     |                 |                |               |                 |                |             |          |   |         |       |        |       |       |       |      |   |         |       |        |       |       |       |         |   |          |       |       |       |       |       |      |   |          |       |       |       |       |       |         |   |          |       |       |       |       |       |      |   |          |       |       |       |       |       |         |
| 1   | 7200.00         | 60.15          | -5.06           | 55.09           | 74.00          | 18.91           | Peak           |             |          |   |         |       |        |       |       |       |      |   |         |       |        |       |       |       |         |   |          |       |       |       |       |       |      |   |          |       |       |       |       |       |         |   |          |       |       |       |       |       |      |   |          |       |       |       |       |       |         |   |  |     |                 |                |               |                 |                |             |          |   |         |       |        |       |       |       |      |   |         |       |        |       |       |       |         |   |          |       |       |       |       |       |      |   |          |       |       |       |       |       |         |   |          |       |       |       |       |       |      |   |          |       |       |       |       |       |         |
| 2   | 7200.00         | 55.68          | -5.06           | 50.62           | 54.00          | 3.38            | Average        |             |          |   |         |       |        |       |       |       |      |   |         |       |        |       |       |       |         |   |          |       |       |       |       |       |      |   |          |       |       |       |       |       |         |   |          |       |       |       |       |       |      |   |          |       |       |       |       |       |         |   |  |     |                 |                |               |                 |                |             |          |   |         |       |        |       |       |       |      |   |         |       |        |       |       |       |         |   |          |       |       |       |       |       |      |   |          |       |       |       |       |       |         |   |          |       |       |       |       |       |      |   |          |       |       |       |       |       |         |
| 3   | 16939.13        | 54.51          | 5.32            | 59.83           | 74.00          | 14.17           | Peak           |             |          |   |         |       |        |       |       |       |      |   |         |       |        |       |       |       |         |   |          |       |       |       |       |       |      |   |          |       |       |       |       |       |         |   |          |       |       |       |       |       |      |   |          |       |       |       |       |       |         |   |  |     |                 |                |               |                 |                |             |          |   |         |       |        |       |       |       |      |   |         |       |        |       |       |       |         |   |          |       |       |       |       |       |      |   |          |       |       |       |       |       |         |   |          |       |       |       |       |       |      |   |          |       |       |       |       |       |         |
| 4   | 16939.13        | 41.96          | 5.32            | 47.28           | 54.00          | 6.72            | Average        |             |          |   |         |       |        |       |       |       |      |   |         |       |        |       |       |       |         |   |          |       |       |       |       |       |      |   |          |       |       |       |       |       |         |   |          |       |       |       |       |       |      |   |          |       |       |       |       |       |         |   |  |     |                 |                |               |                 |                |             |          |   |         |       |        |       |       |       |      |   |         |       |        |       |       |       |         |   |          |       |       |       |       |       |      |   |          |       |       |       |       |       |         |   |          |       |       |       |       |       |      |   |          |       |       |       |       |       |         |
| 5   | 17582.61        | 54.45          | 7.00            | 61.45           | 74.00          | 12.55           | Peak           |             |          |   |         |       |        |       |       |       |      |   |         |       |        |       |       |       |         |   |          |       |       |       |       |       |      |   |          |       |       |       |       |       |         |   |          |       |       |       |       |       |      |   |          |       |       |       |       |       |         |   |  |     |                 |                |               |                 |                |             |          |   |         |       |        |       |       |       |      |   |         |       |        |       |       |       |         |   |          |       |       |       |       |       |      |   |          |       |       |       |       |       |         |   |          |       |       |       |       |       |      |   |          |       |       |       |       |       |         |
| 6   | 17582.61        | 40.53          | 7.00            | 47.53           | 54.00          | 6.47            | Average        |             |          |   |         |       |        |       |       |       |      |   |         |       |        |       |       |       |         |   |          |       |       |       |       |       |      |   |          |       |       |       |       |       |         |   |          |       |       |       |       |       |      |   |          |       |       |       |       |       |         |   |  |     |                 |                |               |                 |                |             |          |   |         |       |        |       |       |       |      |   |         |       |        |       |       |       |         |   |          |       |       |       |       |       |      |   |          |       |       |       |       |       |         |   |          |       |       |       |       |       |      |   |          |       |       |       |       |       |         |

Horizontal

Vertical

Project No.: DG2240110-02152E-RF  
 Polarization: Horizontal  
 Test Mode: Transmitting  
 Note:

Serial No.: 26E6-2  
 Tester: Leesin Xiang

Project No.: DG2240110-02152E-RF  
 Polarization: Vertical  
 Test Mode: Transmitting  
 Note:

Serial No.: 26E6-2  
 Tester: Leesin Xiang

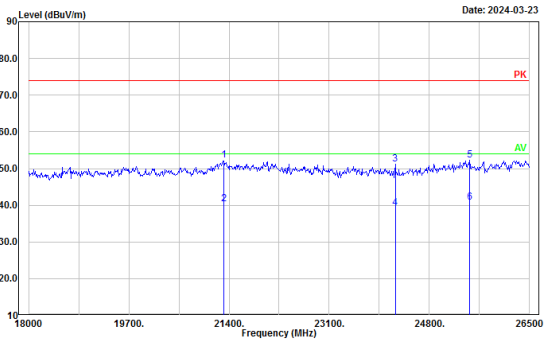
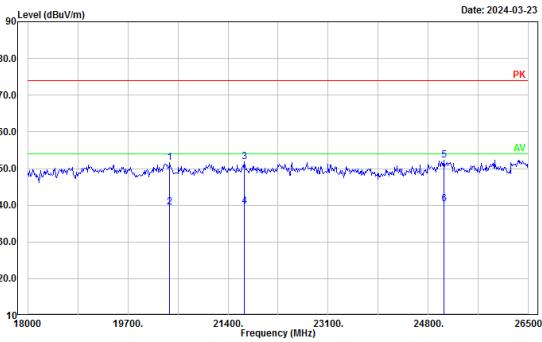

| No. | Frequency (MHz) | Reading (dBuV) | Factor (dB/m) | Result (dBuV/m) | Limit (dBuV/m) | Margin (dB) | Detector |
|-----|-----------------|----------------|---------------|-----------------|----------------|-------------|----------|
| 1   | 20414.49        | 45.73          | 5.96          | 51.69           | 74.00          | 22.31       | Peak     |
| 2   | 20414.49        | 33.45          | 5.96          | 39.41           | 54.00          | 14.59       | Average  |
| 3   | 21671.01        | 45.56          | 6.32          | 51.88           | 74.00          | 22.12       | Peak     |
| 4   | 21671.01        | 33.38          | 6.32          | 39.70           | 54.00          | 14.30       | Average  |
| 5   | 25058.70        | 42.40          | 9.78          | 52.18           | 74.00          | 21.82       | Peak     |
| 6   | 25058.70        | 30.55          | 9.78          | 40.33           | 54.00          | 13.67       | Average  |

| No. | Frequency (MHz) | Reading (dBuV) | Factor (dB/m) | Result (dBuV/m) | Limit (dBuV/m) | Margin (dB) | Detector |
|-----|-----------------|----------------|---------------|-----------------|----------------|-------------|----------|
| 1   | 21313.77        | 45.14          | 7.03          | 52.17           | 74.00          | 21.83       | Peak     |
| 2   | 21313.77        | 33.25          | 7.03          | 40.28           | 54.00          | 13.72       | Average  |
| 3   | 24221.01        | 41.67          | 9.43          | 51.10           | 74.00          | 22.90       | Peak     |
| 4   | 24221.01        | 29.92          | 9.43          | 39.35           | 54.00          | 14.65       | Average  |
| 5   | 25477.54        | 42.07          | 10.24         | 52.31           | 74.00          | 21.69       | Peak     |
| 6   | 25477.54        | 30.48          | 10.24         | 40.72           | 54.00          | 13.28       | Average  |

Project No.: DG2240110-02152E-RF  
 Polarization: Horizontal  
 Test Mode: Transmitting  
 Note:

Serial No.: 26E6-2  
 Tester: Leesin Xiang

Project No.: DG2240110-02152E-RF  
 Polarization: Vertical  
 Test Mode: Transmitting  
 Note:

Serial No.: 26E6-2  
 Tester: Leesin Xiang

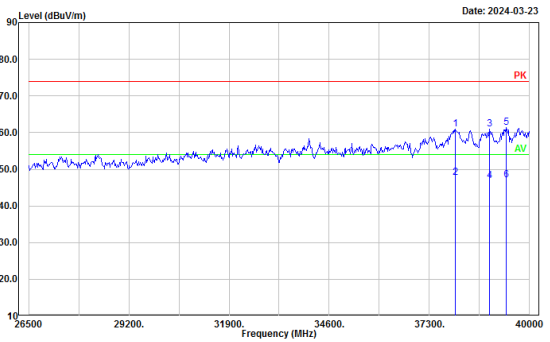
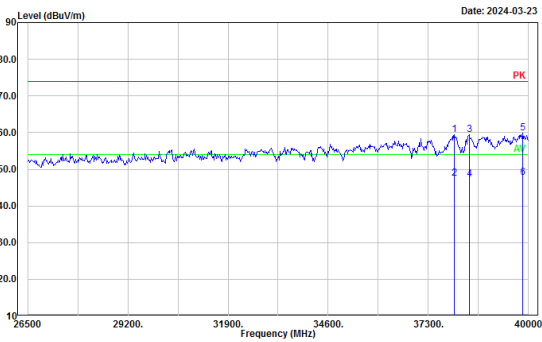

| No. | Frequency (MHz) | Reading (dBuV) | Factor (dB/m) | Result (dBuV/m) | Limit (dBuV/m) | Margin (dB) | Detector |
|-----|-----------------|----------------|---------------|-----------------|----------------|-------------|----------|
| 1   | 38004.35        | 41.52          | 17.89         | 59.41           | 74.00          | 14.59       | Peak     |
| 2   | 38004.35        | 29.52          | 17.89         | 47.41           | 54.00          | 6.59        | Average  |
| 3   | 38395.65        | 41.62          | 17.89         | 59.51           | 74.00          | 14.49       | Peak     |
| 4   | 38395.65        | 29.48          | 17.89         | 47.37           | 54.00          | 6.63        | Average  |
| 5   | 39843.48        | 42.20          | 17.59         | 59.79           | 74.00          | 14.21       | Peak     |
| 6   | 39843.48        | 30.18          | 17.59         | 47.77           | 54.00          | 6.23        | Average  |

| No. | Frequency (MHz) | Reading (dBuV) | Factor (dB/m) | Result (dBuV/m) | Limit (dBuV/m) | Margin (dB) | Detector |
|-----|-----------------|----------------|---------------|-----------------|----------------|-------------|----------|
| 1   | 38004.35        | 43.02          | 17.89         | 60.91           | 74.00          | 13.09       | Peak     |
| 2   | 38004.35        | 29.85          | 17.89         | 47.74           | 54.00          | 6.26        | Average  |
| 3   | 38923.91        | 44.25          | 16.80         | 61.05           | 74.00          | 12.95       | Peak     |
| 4   | 38923.91        | 30.13          | 16.80         | 46.93           | 54.00          | 7.07        | Average  |
| 5   | 39373.91        | 42.94          | 18.37         | 61.31           | 74.00          | 12.69       | Peak     |
| 6   | 39373.91        | 28.74          | 18.37         | 47.11           | 54.00          | 6.89        | Average  |

**4) 40GHz-231GHz:**

| Frequency (GHz) | Receiver             | Polar (H/V) | Factor (dB/m) | Field Strength (dB $\mu$ V/m) | Power Density (pW/cm <sup>2</sup> ) | Limit (pW/cm <sup>2</sup> ) |
|-----------------|----------------------|-------------|---------------|-------------------------------|-------------------------------------|-----------------------------|
|                 | Reading (dB $\mu$ V) |             |               |                               |                                     |                             |
| 41.650          | 56.98                | H           | 39.05         | 96.03                         | 117.37                              | 600.00                      |
| 42.050          | 57.02                | V           | 39.11         | 96.13                         | 120.10                              | 600.00                      |
| 62.350          | 53.41                | H           | 42.28         | 95.69                         | 108.53                              | 600.00                      |
| 61.480          | 53.90                | V           | 42.14         | 96.04                         | 117.64                              | 600.00                      |
| 91.870          | 60.32                | H           | 45.34         | 105.66                        | 269.46                              | 600.00                      |
| 90.810          | 61.74                | V           | 45.21         | 106.95                        | 362.65                              | 600.00                      |
| 142.320         | 59.14                | H           | 48.99         | 108.13                        | 475.87                              | 600.00                      |
| 141.060         | 59.39                | V           | 48.94         | 108.33                        | 497.72                              | 600.00                      |
| 221.320         | 50.62                | H           | 52.45         | 103.07                        | 148.42                              | 1000.00                     |
| 220.680         | 51.33                | V           | 52.42         | 103.75                        | 173.58                              | 1000.00                     |

### 4.3 Frequency Stability:

#### 4.3.1 Applicable Standard

FCC §95.3379 (b)

(b) Fundamental emissions must be contained within the frequency bands specified in this section during all conditions of operation. Equipment is presumed to operate over the temperature range  $-20$  to  $+50$  degrees Celsius with an input voltage variation of 85% to 115% of rated input voltage, unless justification is presented to demonstrate otherwise.

#### 4.3.2 EUT Setup Block Diagram

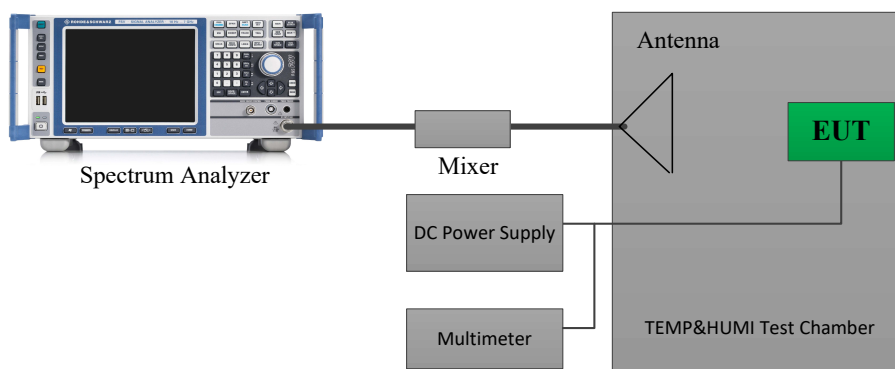

#### 4.3.3 Test Procedure

C63.26-2015, Clause 5.6

Frequency stability is a measure of the frequency drift due to temperature and supply voltage variations, with reference to the frequency measured at  $+20$  °C and rated supply voltage. The operating carrier frequency shall be set up in accordance with the manufacturer's published operation and instruction manual prior to the commencement of these tests. No adjustment of any frequency determining circuit element shall be made subsequent to this initial set-up. Frequency stability is tested:

- a) At  $10$  °C intervals of temperatures between  $-30$  °C and  $+50$  °C at the manufacturer's rated supply voltage, and
- b) At  $+20$  °C temperature and  $\pm 15\%$  supply voltage variations. If a product is specified to operate over a range of input voltage then the  $-15\%$  variation is applied to the lowermost voltage and the  $+15\%$  is applied to the uppermost voltage. During the test all necessary settings, adjustments and control of the EUT have to be performed without disturbing the test environment, i.e., without opening the environmental chamber. The frequency stabilities can be maintained to a lesser temperature range provided that the transmitter is automatically inhibited from operating outside the lesser temperature range. For handheld equipment that is only capable of operating from internal batteries and the supply voltage cannot be varied, the frequency stability tests shall be performed at the nominal battery voltage and the battery end point voltage specified by the manufacturer. An external supply voltage can be used and set at the internal battery nominal voltage, and again at the battery operating end point voltage which shall be specified by the equipment manufacturer. If an unmodulated carrier is not available, the mean frequency of a modulated carrier can be obtained by using a frequency counter with gating time set to an appropriately large multiple of bit periods (gating time depending on the required accuracy). Full details on the choice of values shall be included in the test report.

**4.3.4 Test Result**

|                |           |              |              |
|----------------|-----------|--------------|--------------|
| Serial Number: | 2GE6-2    | Test Date:   | 2024/2/7     |
| Test Site:     | RF        | Test Mode:   | Transmitting |
| Tester:        | Bill Yang | Test Result: | Pass         |

| Environmental Conditions: |      |                           |    |                           |       |
|---------------------------|------|---------------------------|----|---------------------------|-------|
| Temperature:<br>(°C)      | 23.1 | Relative Humidity:<br>(%) | 62 | ATM<br>Pressure:<br>(kPa) | 101.2 |

**Test Equipment List and Details:**

| Manufacturer | Description            | Model       | Serial Number | Calibration Date | Calibration Due Date |
|--------------|------------------------|-------------|---------------|------------------|----------------------|
| OML          | Waveguide Mixer        | WR12/M12HWD | E60120-1      | 2023/2/16        | 2026/2/15            |
| OML          | Horn Antenna           | M12RH       | E60120-2      | 2023/2/27        | 2026/2/26            |
| R&S          | Spectrum Analyzer      | FSV40       | 101944        | 2023/10/18       | 2024/10/17           |
| BACL         | TEMP&HUMI Test Chamber | BTH-150-40  | 30173         | 2023/10/18       | 2024/10/17           |
| All-sun      | Clamp Meter            | EM305A      | 8348897       | 2023/8/3         | 2024/8/2             |
| TDK-Lambda   | DC Power Supply        | Z+60-14     | F-08-EM038-1  | N/A              | N/A                  |

\* Statement of Traceability: Bay Area Compliance Laboratories Corp. (Dongguan) attests that all calibrations have been performed, traceable to National Primary Standards and International System of Units (SI).

**Test Data:**

| Temperature | Voltage | Frequency (GHz) |                |                      |                      |
|-------------|---------|-----------------|----------------|----------------------|----------------------|
|             |         | f <sub>L</sub>  | f <sub>H</sub> | f <sub>L</sub> Limit | f <sub>H</sub> Limit |
| -20         | 12      | 76.0656         | 76.8575        | 76                   | 81                   |
| -10         | 12      | 76.0654         | 76.8576        | 76                   | 81                   |
| 0           | 12      | 76.0654         | 76.8577        | 76                   | 81                   |
| 10          | 12      | 76.0657         | 76.8573        | 76                   | 81                   |
| 20          | 12      | 76.0659         | 76.8577        | 76                   | 81                   |
| 30          | 12      | 76.0653         | 76.8571        | 76                   | 81                   |
| 40          | 12      | 76.0656         | 76.8573        | 76                   | 81                   |
| 50          | 12      | 76.0658         | 76.8576        | 76                   | 81                   |
| 20          | 8       | 76.0651         | 76.8577        | 76                   | 81                   |
| 20          | 16      | 76.0657         | 76.8574        | 76                   | 81                   |

Note: the operation voltage range was declared by manufacturer.

### 4.4 Occupied Bandwidth:

#### 4.4.1 Applicable Standard

FCC §2.1049

The occupied bandwidth, that is the frequency bandwidth such that, below its lower and above its upper frequency limits, the mean powers radiated are each equal to 0.5 percent of the total mean power radiated by a given emission shall be measured.

653005 D01 76-81 GHz Radars v01r02 clause 4 d)

The occupied bandwidth of the radar device shall be measured, reported, and shown to be fully contained within the designated 76-81 GHz frequency band under normal operating conditions as well as under those extreme ambient temperature and input voltage conditions as described in Section 2.1057.

#### 4.4.2 EUT Setup

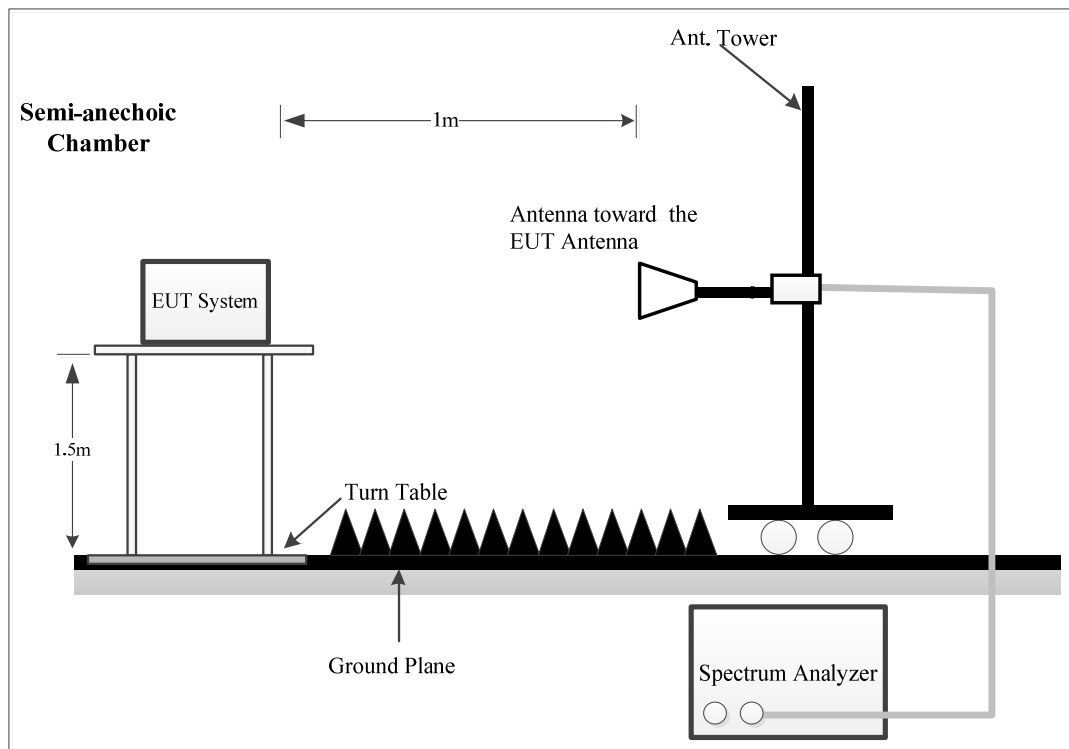

Place the measurement antenna in the main beam of the EUT then maximize the fundamental emission, noting that multiple peaks can be found at different beam orientations and/or polarizations.

#### 4.4.3 Test Procedure

C63.26-2015, Clause 5.4.4

The OBW is the frequency bandwidth such that, below its lower and above its upper frequency limits, the mean powers are each equal to 0.5% of the total mean power of the given emission.

The following procedure shall be used for measuring (99%) power bandwidth:

- a) The spectrum analyzer center frequency is set to the nominal EUT channel center frequency. The frequency span for the spectrum analyzer shall be set wide enough to capture all modulation products including the emission skirts (typically a span of  $1.5 \times \text{OBW}$  is sufficient).
- b) The nominal IF filter 3 dB bandwidth (RBW) shall be in the range of 1% to 5% of the anticipated OBW, and the VBW shall be set  $\geq 3 \times \text{RBW}$ .
- c) Set the reference level of the instrument as required to prevent the signal amplitude from exceeding the maximum spectrum analyzer input mixer level for linear operation. See guidance provided in 4.2.3.  
NOTE—Step a), step b), and step c) may require iteration to adjust within the specified tolerances.
- d) Set the detection mode to peak, and the trace mode to max-hold.
- e) If the instrument does not have a 99% OBW function, recover the trace data points and sum directly in linear power terms. Place the recovered amplitude data points, beginning at the lowest frequency, in a running sum until 0.5% of the total is reached. Record that frequency as the lower OBW frequency. Repeat the process until 99.5% of the total is reached and record that frequency as the upper OBW frequency. The 99% power OBW can be determined by computing the difference these two frequencies.
- f) The OBW shall be reported and plot(s) of the measuring instrument display shall be provided with the test report. The frequency and amplitude axis and scale shall be clearly labeled. Tabular data can be reported in addition to the plot(s).



**4.4.5 Test Result**

|                |           |              |              |
|----------------|-----------|--------------|--------------|
| Serial Number: | 2GE6-2    | Test Date:   | 2024/2/7     |
| Test Site:     | Chamber A | Test Mode:   | Transmitting |
| Tester:        | Bill Yang | Test Result: | Pass         |

**Environmental Conditions:**

|                      |      |                           |    |                           |       |
|----------------------|------|---------------------------|----|---------------------------|-------|
| Temperature:<br>(°C) | 23.1 | Relative Humidity:<br>(%) | 62 | ATM<br>Pressure:<br>(kPa) | 101.2 |
|----------------------|------|---------------------------|----|---------------------------|-------|

**Test Equipment List and Details:**

| Manufacturer | Description       | Model       | Serial Number | Calibration Date | Calibration Due Date |
|--------------|-------------------|-------------|---------------|------------------|----------------------|
| OML          | Waveguide Mixer   | WR12/M12HWD | E60120-1      | 2023/2/16        | 2026/2/15            |
| OML          | Horn Antenna      | M12RH       | E60120-2      | 2023/2/27        | 2026/2/26            |
| R&S          | Spectrum Analyzer | FSV40       | 101944        | 2023/10/18       | 2024/10/17           |

\* Statement of Traceability: Bay Area Compliance Laboratories Corp. (Dongguan) attests that all calibrations have been performed, traceable to National Primary Standards and International System of Units (SI).

**Test Data:**

| 99% Occupied Bandwidth (MHz)  | F <sub>L</sub> (GHz) | F <sub>L</sub> Limit (GHz) | F <sub>H</sub> (GHz) | F <sub>H</sub> Limit (GHz) |
|---|----------------------|----------------------------|----------------------|----------------------------|
| 791.896   | 76.06585             | 76.000                     | 76.85774             | 81.000                     |
| Note:<br>F <sub>L</sub> is the Low frequency of the 99% Occupied bandwidth.<br>F <sub>H</sub> is the Upper frequency of the 99% Occupied bandwidth. |                      |                            |                      |                            |

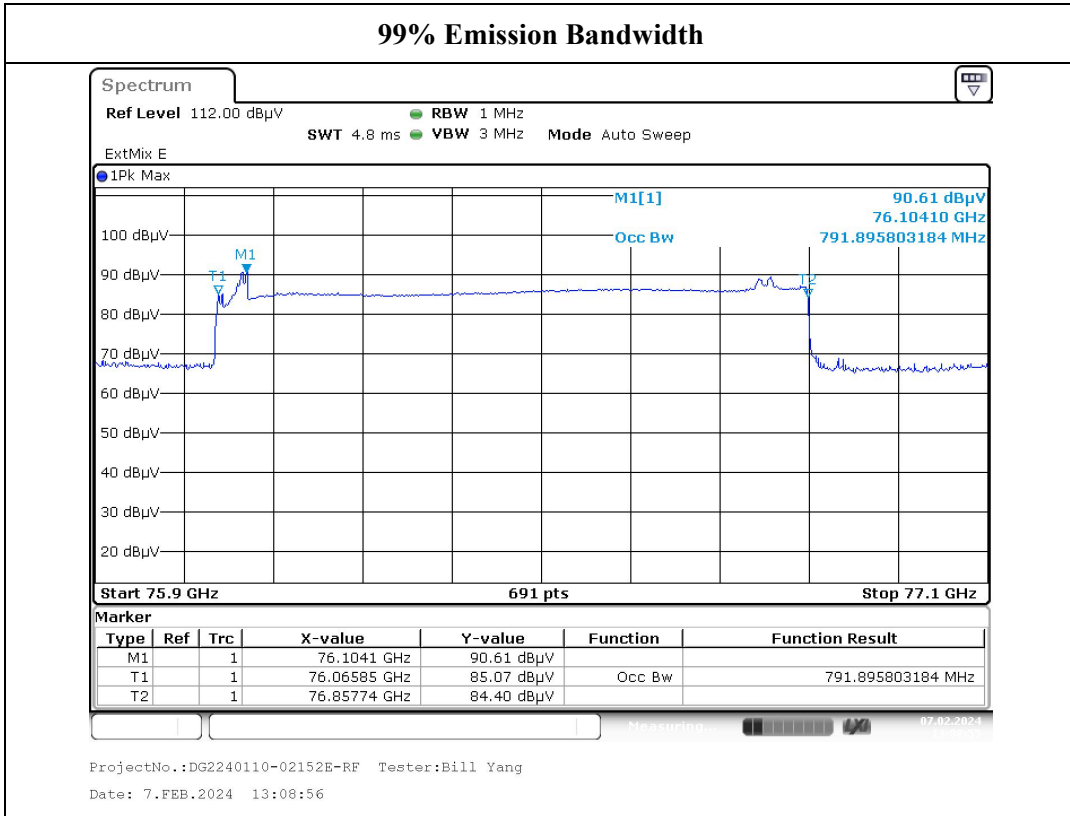

---

## **APPENDIX A - EUT PHOTOGRAPHS**

---

Please refer to the attachment DG2240110-02152E-RF-EXP EUT EXTERNAL PHOTOGRAPHS and DG2240110-02152E-RF-INP EUT INTERNAL PHOTOGRAPHS

---

**APPENDIX B - TEST SETUP PHOTOGRAPHS**

---

Please refer to the attachment DG2240110-02152E-RF-00B-TSP TEST SETUP PHOTOGRAPHS.

**APPENDIX C - RF EXPOSURE EVALUATION**

**Applicable Standard**

FCC §95.3385 & §1.1310 & §2.1091

Regardless of the power density levels permitted under this subpart, devices operating under the provisions of this subpart are subject to the radiofrequency radiation exposure requirements specified in §§ 1.1307(b), 2.1091, and 2.1093 of this chapter, as appropriate. Applications for equipment authorization of devices operating under this section must contain a statement confirming compliance with these requirements for both fundamental emissions and unwanted emissions. Technical information showing the basis for this statement must be submitted to the Commission upon request.

Systems operating under the provisions of this section shall be operated in a manner that ensures that the public is not exposed to radio frequency energy levels in excess of the Commission's guidelines. See §1.1307(b)(1) of this chapter.

Limits for Maximum Permissible Exposure (MPE) (§1.1310, §2.1091)

| <b>(B) Limits for General Population/Uncontrolled Exposure</b> |                                      |                                      |  |                                 |
|--|--------------------------------------|--------------------------------------|--|---------------------------------|
| <b>Frequency Range (MHz)</b>                                   | <b>Electric Field Strength (V/m)</b> | <b>Magnetic Field Strength (A/m)</b> | <b>Power Density (mW/cm<sup>2</sup>)</b> | <b>Averaging Time (minutes)</b> |
| 0.3–1.34   | 614                                  | 1.63                                 | *(100)                                   | 30                              |
| 1.34–30  | 824/f                                | 2.19/f                               | *(180/f <sup>2</sup> )                   | 30                              |
| 30–300   | 27.5                                 | 0.073                                | 0.2                                      | 30                              |
| 300–1500   | /                                    | /                                    | f/1500                                   | 30                              |
| 1500–100,000   | /                                    | /                                    | 1.0                                      | 30                              |

f = frequency in MHz; \* = Plane-wave equivalent power density;

According to §1.1310 and §2.1091 RF exposure is calculated.

**Procedure**

Prediction of power density at the distance of the applicable MPE limit

$S = PG/4\pi R^2$  = power density (in appropriate units, e.g. mW/cm<sup>2</sup>);

P = power input to the antenna (in appropriate units, e.g., mW);

G = power gain of the antenna in the direction of interest relative to an isotropic radiator, the power gain factor, is normally numeric gain;

R = distance to the center of radiation of the antenna (appropriate units, e.g., cm);

**Measurement Result**

| <b>Frequency (GHz)</b> | <b>EIRP Peak Output power including Tune-up Tolerance</b> |             | <b>Evaluation Distance (cm)</b> | <b>Power Density (mW/cm<sup>2</sup>)</b> | <b>MPE Limit (mW/cm<sup>2</sup>)</b> |
|------------------------|---|-------------|---------------------------------|--|--------------------------------------|
|                        | <b>(dBm)</b>  | <b>(mW)</b> |                                 |  |                                      |
| 76.065-76.860          | 24  | 251.1886    | 20                              | 0.1503                                   | 1.0                                  |

**Result:** The device meet FCC MPE at 20 cm distance.

**===== END OF REPORT =====**